



**Oregon  
Department  
of Transportation**

# **GEOTECHNICAL DESIGN MANUAL**

**Delivery & Operations Division | Engineering &  
Technical Services Branch**

**January 2023**

---

## **GEOTECHNICAL DESIGN MANUAL**

ODOT is an Equal Employment Opportunity and Affirmative Action Employer.

This information can be made available in alternative format by contacting (ENTER phone number of division, section or person responsible for the publication).

ODOT does not discriminate on the basis of disability in admission or access to our programs, services, activities, hiring and employment practices. Questions: 1-877-336-6368 (EEO-ODOT) or through Oregon Relay Service at 7-1-1.

### **Oregon Department of Transportation**

Statewide Project Delivery Branch – Engineering & Technical Services Branch

Geotechnical Engineering & Engineering Geology Section

4040 Fairview Industrial Dr. SE MS 6

Salem, OR 97302

Office: (503) 986-6591

Fax: (503) 986-3249

<https://www.oregon.gov/odot/GeoEnvironmental/Pages/Geotech-Manual.aspx>

# Table of Contents

---

Table of Contents .....	i
Summary Of Changes .....	ii
Chapter 1 - Introduction .....	1-1
Chapter 2 - Quality Control & Quality Assurance.....	2-1
Chapter 3 - Project Geotechnical Planning.....	3-1
Chapter 4 - Field Investigation .....	4-1
Chapter 5 - Soil and Rock Classification and Logging.....	5-1
Chapter 6 - Engineering Properties of Soil and Rock .....	6-1
Chapter 7 - Slope Stability Analysis.....	7-1
Chapter 8 - Material Source.....	8-1
Chapter 9 - Embankments – Analysis and Design .....	9-1
Chapter 10 - Soil Cuts - Analysis and Design.....	10-1
Chapter 11 - Rock Cuts – Analysis, Design, and Mitigation.....	11-1
Chapter 12 - Reserved.....	12-1
Chapter 13 - Seismic Design .....	13-1
Chapter 14 - Ground Improvement .....	14-1
Chapter 15 - Geosynthetic Design .....	15-1
Chapter 16 - Retaining Structures .....	16-1
Chapter 17 - Foundation Design .....	17-1
Chapter 18 - Culverts and Trenchless Technology Design .....	18-1
Chapter 19 - Construction Recommendations and Reporting.....	19-1
Chapter 20 - Geotechnical Reporting and Documentation .....	20-1





<b>Chapter</b>	<b>Summary of changes made</b>	<b>Date revised</b>
	<ul style="list-style-type: none"><li>• Appendix D</li></ul> Updated All Chapter Content	
		03/27/18
<b>17</b>	Renumbered Chapter from Chapter 8& 16 to Chapter 17	01/18/2023
	Sections updated:	05/06/2019
	16.9	
	Updated All Chapter Content	3/27/2018
<b>18</b>	Renumbered Chapter from Chapter 17 to Chapter 18	01/18/2023
	Updated sections	
	<ul style="list-style-type: none"><li>• 17.1</li><li>• 17.2</li><li>• 17.2.1</li><li>• 17.2.2</li><li>• 17.2.3</li><li>• 17.2.4</li><li>• 17.2.5</li><li>• 17.2.6</li></ul>	
	Updated All Chapter Content	05/06/2019
<b>19</b>	Renumbered Chapter from Chapter 18 to Chapter 19	01/18/2023
	Updated All Chapter Content	3/27/2018
<b>20</b>	Renumbered Chapter from Chapter 21 to Chapter 20	01/18/2023
	Updated All Chapter Content	3/27/2018

---

# Chapter 1 - Introduction



## Chapter Contents

---

<b>Chapter 1 - Introduction .....</b>	<b>1-1</b>
1.1 General.....	1-2
1.2 Overview .....	1-3
1.3 Manual Revisions, Project Specific Geotechnical Standards Deviation .....	1-3
1.3.1 Manual Revision Procedure.....	1-3
1.3.2 Deviation from Geotechnical Standards .....	1-4
1.4 ODOT Geotechnical Organization .....	1-6
1.5 Special Geotechnical Procedures .....	1-6
1.5.1 Geologic and Geotechnical Data .....	1-6
1.5.2 Cyclic Direct Simple Shear Testing (CDSS) .....	1-7

## List of Tables

---

Table 1-1 Technical Resources.....	1-5
------------------------------------	-----

## 1.1 General

At the direction of ODOT's Chief Engineer, the *ODOT Geotechnical Design Manual (GDM)* establishes standard policies and procedures regarding geotechnical work performed for ODOT (DES 05-02). The manual covers geotechnical investigations, analysis, design, and reporting for earthwork and structures for highways. The purpose of the GDM is to establish investigation and design standards, furnish information for an optimum design, which will minimize over-conservatism, as well as to minimize under-design and the resulting failures commonly and mistakenly attributed to unforeseen conditions. All State of Oregon projects are required to meet the design standards in the GDM.

Specific changes in the 2023 edition of the GDM are quite significant. Since the establishment of the GDM circa 2006 there have been significant policy, standards, quality control and required documentation changes within ODOT for the geotechnical profession. In an effort to improve quality of project delivery, statewide consistency, and quality control, this edition captures some of these changes by; reordering the Chapters in order of project delivery, emphasizing quality control and quality assurance in [Chapter 2](#), and providing instructions for special efforts to advance the practice of the Geotechnical disciplines.

For the first time since the publishing of the Soil and Rock Classification Manual, there are significant changes. With the publishing of this new version of the Soil and Rock Classification Manual, any projects in development that have not completed the DAP phase will use the current Soil and Rock Classification Manual. The 1987 Soil and Rock Classification Manual will only be available for completion of existing projects that have completed the DAP phase and existing construction projects. The current version of the Soil and Rock Classification and Logging is now [Chapter 5](#) of the GDM. All Geotechnical Reporting Documents thereafter will use the most current version of the GDM. [Chapter 5](#) of the GDM replaces the 1987 Soil and Rock Classification Manual.

An effort is currently underway to combine both geotechnical and structural seismic design criteria in a stand-alone manual. The current Seismic Design, [Chapter 13](#), will be sunset upon the publishing on the *Seismic and Tsunami Design Criteria Manual*, all projects without DAP acceptance will use the Seismic and Tsunami Design Criteria Manual.

Foundation design for bridges, signs, signals, luminaires, sound walls, and buildings have been combined into one chapter titled Foundation Design. Similarly, the previously titled chapters Construction Recommendations and Report have been merged with Geotechnical Reporting and Documentation for a more efficient and succinct manual.

[Table 1-1](#), of this chapter, provides a crosswalk between GDM 2022 and the previously published manual as well as the Technical Resource and contact information. The Technical Resources listed in this table should be the first point of contact for project questions, design deviation requests, and any suggestions for manual changes.

Finally, a subsection titled [Special Geotechnical Procedures](#) has been added to [Chapter 1](#) to emphasize recent changes and efforts in geotechnical programs.



## 1.2 Overview

Even the most rigorous geotechnical investigation will reveal only a small percentage of the subsurface materials beneath a project. Further, it would be impractical to provide a rigid set of specifications for all possible cases. Therefore, this manual will not address all subsurface problems and leaves many areas where individual geologic and engineering professional judgment must be used. It is intended that the procedures discussed in this manual will establish a reasonable and uniform set of standards, policies and procedures while maintaining sufficient flexibility to permit the application of engineering analysis to the solution of geotechnical problems.

This manual references publications, presents specific engineering design, construction, or laboratory testing procedures. Each chapter contains a listing of associated references for the subject area of the chapter. Among the commonly referenced materials are the publications of the American Association of State Highway Transportation Officials ([AASHTO](#)), the Federal Highway Administration ([FHWA](#)), and the American Society for Testing and Materials ([ASTM](#)).

The ODOT Geotechnical Engineering and Engineering Geology Section is responsible for the publication and modification of this manual. Any comments or questions about the *ODOT Geotechnical Design Manual* should be directed to the Technical Resource professional listed in [Table 1-1](#).

## 1.3 Manual Revisions, Project Specific Geotechnical Standards Deviation

### 1.3.1 Manual Revision Procedure

The GDM is continually updated by headquarters' staff to clarify ODOT geotechnical practices and to include new practices and information as they come into broad usage. Revisions and submittals from all users of the GDM, both internal (ODOT) and external (Consultants and others), are encouraged. Users of the GDM should follow the instructions for defining the problem and put it in writing as complete as possible and email to either the Technical Resource found in [Table 1-1](#) or to the State Geotechnical Engineer for consideration and follow up. Use the following procedure when submitting suggested manual revisions to the Technical Resource.

#### 1. Define the problem

Discuss the suggestion or revision of the GDM with others that have a stake in the outcome. If it is agreed that the item should be proposed, develop a written proposal. Changes to design policy, design practice, or procedures can have wide-ranging effects – including preparation of contract documents for ODOT. Proposed changes to design standards should be consistent with AASHTO and FHWA design procedures.

**2. Put it in writing**

Research and develop a written proposal using the three general subject headings:

- Problem Statement.
- Analysis/ Research Data.
- Proposal.

Check the finished product by reviewing the following guiding comments:

- The existing problem is clearly stated.
- Research and analysis of the problem and potential solution are thorough and understandable.
- The proposed solution is well thought out, is supported by facts, and solves the problem. Has the impact on other areas been considered? Have the details been coordinated with other units or organizations that may be affected?
- No questions remain that need to be answered before implementation.

**3. Submittal, Review and Approval**

Submit proposed manual revisions to the Technical Resource in [Table 1-1](#). After reviewing the written proposal for technical validity, completeness, and business applicability, the technical resource Geotechnical Engineering and Engineering Geology Section will either:

- Accept, without further review, manual corrections for inclusion in the GDM, or
- Distribute proposed manual revisions to internal (ODOT) stakeholders for review and comments.

After receiving review comments from internal stakeholders, the Geotechnical Engineering and Engineering Geology Section will do one of the following:

- Accept proposed revisions and incorporate them into the next upcoming version of the GDM, or
- Return submittal to the originator with comments and recommendations for revision and resubmittal.

Regardless of whether or not a proposal is accepted, the Geotechnical Engineering and Engineering Geology Section will reply in writing to the person making the submittal.

**4. Implementation of Approved Revision**

Proposals will be incorporated electronically into the GDM on the ODOT web page as soon as practical.

## **1.3.2 Deviation from Geotechnical Standards**

All State of Oregon projects are required to meet ODOT design standards. Design deviation requests will be submitted for all STIP projects which do not meet standards and have a Design

Acceptance Package milestone date after **July 1, 2018**. A request for a deviation from design standards is appropriate when the request benefits the project and is supported by rational engineering principles. Deviations to design standards should be discussed early in the design process with the **assigned** Technical Resource ([Table 1-1](#)).

For geotechnical design deviations, the proposal is prepared by the Professional of Record (POR) using the Geotechnical Design Deviation Request Form ([Design Deviation Request](#)). The **Design Deviation Request** should be used to document the **applicable** geotechnical design standard(s) from which deviation is being requested. **Furthermore**, it should also provide a justification for the need and proposed solution for the deviation. **It should also include** the risks, hazards, consequences and effects of the deviation. The POR should **coordinate** with the project team when developing the request. **A draft of the deviation request should be submitted to the applicable Technical Resource ([Table 1-1](#))** for review by the senior Headquarters staff, and recommendation made to the State Geotechnical Engineer. All Design Deviation Requests will be reviewed by Sr. Geologist (GES), Sr. Geotechnical Engineer (GES or BES), and Technical Resource for recommendation to the Delegated Authority for approval. **Subsequent discussions and negotiations concerning the deviation will generally be conducted between the Technical Resource and the Professional of Record. The final Design Deviation Request is filed in ProjectWise with concurrence signatures from the Tech Center Manager and notice provided to the Technical Resource that the document is available for approval.**

The **Design Deviation Request** is available at the following link: [Design Deviation Request](#).

**Table 1-1 Technical Resources**

Pre-2022	Chapter	Title	Technical Resource
1	1	Introduction	<a href="#">Susan Ortiz</a>
23	2	Quality Control & Quality Assurance	<a href="#">Susan Ortiz</a>
2	3	Project Geotechnical Planning	<a href="#">Curran Mohney</a>
3	4	Field Investigation	<a href="#">Curran Mohney</a>
Separate	5	Soil and Rock Classification and Logging	<a href="#">Curran Mohney</a>
5	6	Engineering Properties of Soil and Rock	<a href="#">Susan Ortiz</a>
7	7	Slope Stability Analysis	<a href="#">Susan Ortiz</a>
20	8	Material Sources Report	<a href="#">Curtis Ehlers</a>
9	9	Embankments – Analysis and Design	<a href="#">Susan Ortiz</a>
10	10	Soil Cuts – Analysis and Design	<a href="#">Susan Ortiz</a>
12	11	Rock Cuts – Analysis, Design and Mitigation	<a href="#">Curran Mohney</a>
13	12	Landslide Investigation and Mitigation	<a href="#">Curran Mohney</a>

Pre-2022	Chapter	Title	Technical Resource
6	13	Seismic Design	<a href="#">Susan Ortiz</a>
	14	Ground Improvement	<a href="#">Susan Ortiz</a>
14	15	Geosynthetic Design	<a href="#">Sophie Brown</a>
15	16	Retaining Structures	<a href="#">Sophie Brown</a>
8, and 16	17	Foundation Design	<a href="#">Susan Ortiz</a>
17	18	Culverts and Trenchless Technology Design	<a href="#">Sophie Brown</a>
18	19	Construction Recommendations and Reporting	<a href="#">Susan Ortiz</a>
21	20	Geotechnical Reporting and Documentation	<a href="#">Susan Ortiz</a>

## 1.4 ODOT Geotechnical Organization

The functions of geotechnical design in ODOT are generally managed and performed within the five Region offices. Tech Centers within each region are staffed with Geotechnical Engineers, and Engineering Geologists. The geotechnical design, construction, and maintenance support may be performed in-house or contracted out to specialty consultants. The ODOT Technical Services Geotechnical Engineering and Engineering Geology Section sets standards, procedures, and policy, provides design assistance and review, organizes training, initiates section goals for geotechnical work, ensures workload is staffed with competent PORs, process improvement, research, implement state-of-the-art practice and standard-of-practice standards.

## 1.5 Special Geotechnical Procedures

Long-term efforts such as Geotechnical Asset Management and research require consistency and specificity. In an effort to maintain momentum for these programs, which ultimately improve project efficiency, explicit actions are required. As such, the special geotechnical efforts section of the GDM is reserved to emphasize new or on-going efforts.

### 1.5.1 Geologic and Geotechnical Data

Inarguably the most vital component of a geologic interpretation and geotechnical design is the subsurface exploration, and in-situ testing. Regardless of the extent of exploration and testing, more data is always useful. As such, legacy data is useful to improve overall understanding of the geologic setting, engineering properties, and maintenance repairs. Further, access and consistency of the raw electronic data facilitates ease of use. Ideally, all data retrieved for a project is filed and stored in ProjectWise. Examples of data include but not limited to:

exploration logs, Cone Penetration Test (CPT) files, Direct Simple Shear, Cyclic Direct Simple Shear, suspension logging, and geophysical data. This data is stored in ProjectWise in their raw useable electronic format such as \*.gnt for borehole log, etc.

Agency goals with respect to geotechnical information asset management includes single-source access to all geologic and geotechnical data produced by and for the agency in a geospatial database. This will be achieved in a measured process starting with newly-collected data and eventually expand to include all of the data collected by the agency that still exists in various formats. To this end, explorations are required to be labeled with unique alphanumeric codes to facilitate their incorporation into a database. Exploration naming standards are set forth in [Chapter 5](#).

## 1.5.2 Cyclic Direct Simple Shear Testing (CDSS)

Studies of Willamette Silt in Western Oregon were initiated in the mid-1990's and continue in an effort to determine the cyclic response of these unique soils which underlie the majority of Oregon's population. To better understand these soils specific sampling, and testing criteria is required to bolster the existing dataset of Willamette Silt data. If an ODOT STIP project can justify the cost of testing (~\$20k) with an overall savings in project costs, then CDSS testing should be completed. Until recently, CDSS testing availability for ODOT projects was limited to resources outside the Country. Currently, there are several consulting firms and two Universities in Oregon that are able to perform this testing.

Paired mud rotary borings and CPT soundings are required for site investigations where CDSS testing will be used. Undisturbed sampling, storage, and transport to the laboratory require careful handling as these transitional soils are subject to easy disturbance.

Testing protocol requires the following tests to be performed for each sample: index tests, soil classification with particle size distribution, constant rate-of-strain consolidation test where  $\sigma'_{vo} = \sigma'_{vc}$ , a minimum of four constant-volume, monotonic direct simple shear tests over a range of OCRs from 1 to 8, and a minimum of four constant-volume, stress-controlled, Cyclic Direct Simple Shear (CDSS) tests. All test results in the raw data form, in excel format, are stored in ProjectWise with the associated project. Geotechnical Reporting Documents will include the laboratory test results, procedures, interpretation and application for each project.

If you have questions regarding the testing protocol requirements, data storage, interpretation, reporting requirements or application do not hesitate to contact the Seismic Design Technical Resource ([Table 1-1](#)).

# Chapter 2 - Quality Control & Quality Assurance



## Chapter Contents

<b>Chapter 2 - Quality Control &amp; Quality Assurance</b> .....	<b>2-1</b>
2.1 General.....	2-3
2.1.1 Consultant Work Products .....	2-4
2.2 Geotechnical Quality Standards .....	2-4
2.3 Roles <b>and Responsibilities</b> .....	2-4
2.4 Geotechnical Process .....	2-5
2.4.1 Quality Control Reviews.....	2-6
2.4.2 Reviewer Authority .....	2-6
2.5 Glossary .....	2-7
2.6 Geotechnical Documentation .....	2-8
2.7 Project Phases .....	2-11
2.7.1 Scoping Notes .....	2-12
2.7.2 Initial Site Visit/Reconnaissance Memo .....	2-12
2.7.3 Exploration Program/Plan .....	2-12
2.7.4 Laboratory Program/Plan And Sample Selection.....	2-14
2.7.5 Field Explorations And Draft Drill Logs.....	2-15
2.7.6 Geology Summary .....	2-16
2.7.7 Draft Geotechnical Data Sheets.....	2-17
2.7.8 Analysis And Design .....	2-17
2.7.9 Geotechnical Memo .....	2-18
2.7.10 Design Deviation Request.....	2-19
2.7.11 Geotechnical Report.....	2-19
2.7.12 Special Provisions.....	2-20
2.7.13 Geotechnical Report And Complete Plans And Specifications .....	2-20

2.7.14 Edits To Geotechnical Report By Addenda..... 2-20  
2.7.15 Geo Contributions To PS&E ..... 2-20  
2.7.16 Significant Project Changes After PS&E ..... 2-20  
2.8 Quality Assurance..... 2-21  
    2.8.1 Quality Assurance Process..... 2-21  
2.9 References ..... 2-22  
Appendix 2 –A Swimlanes through project scoping ..... 2-23  
Appendix 2–B Swimlanes DAP through Final Plans..... 2-24  
Appendix 2–C Swimlanes through Construction ..... 2-25  
Appendix 2–D Quality Assurance Swimlanes..... 2-26

**List Of Tables**

---

Table 2-1 Geotechnical Deliverables Documentation Quality Control Requirements..... 2-9

## 2.1 General

The Oregon Department of Transportation recognizes that its success will be determined, in part, by the quality of services and products that it provides for its customers. Assuring quality requires not only a commitment but also a consistent systematic approach **that can be documented**. The ODOT geotechnical quality control program endeavors to go beyond the review of work products to result in a continuous improvement of the processes and products associated with geotechnical services.

The ultimate goal of quality control is to achieve an overall quality of work in all endeavors that meets or exceeds the goals of the agency. Within that context, the intent of implementing this quality control program includes the following:

- To emphasize the importance of quality in achieving the goals of the Agency. In particular, to **emphasize** communication, collaboration, and care in completing geologic and geotechnical engineering work. This is consistent with the values enunciated in ODOT's Mission Statement, **"EXCELLENCE: We use our skills and expertise to continuously strive to be more efficient, effective and innovative."**
- To assist in leveraging the highest levels of experience and technical expertise available, with respect to all projects, not just those that are large or complicated.
- To assure and document compliance of Geotechnical Reporting Documents (GRDs) with design codes, standards of practice, legal requirements and organizational policy.
- To allow for an analysis of the strengths and weaknesses of completed projects in order to develop a process of continual improvement.
- To **develop skills and** support to individual project designers. Collaborating with other experienced individuals helps the Professional of Record be more confident in their work and results.
- To provide mentoring for **designers** to develop experience and expand their abilities. Often, the best training comes from working on a project with a reviewer who has more experience. Similarly, experienced staff often learns from recent graduates and young staff that have been exposed to recent advances in the profession through their educational experience and offer a fresh perspective..
- To identify and address mistakes, oversights and logic errors and to compensate for inexperience. All people can and do make mistakes despite their knowledge, experience, or level of effort. A collaborative approach to work and the involvement of independent reviewers will nearly always result in the elimination of mistakes or errors of logic that would not be identified by a single dedicated individual.

The **Quality Control (QC)** process is not intended to relieve Professionals of Record (POR) from responsibility for their work products **but rather to critically review with a fresh perspective and identify fatal flaws**. Ultimately, the POR is responsible for self-checking their work and maintaining compliance with applicable manuals, standards of practice, errors, and omissions.



This manual uses the term Geotechnical Reporting Documents (GRD) which is derived from the FHWA document, “Assuring Quality in Geotechnical Reporting Documents” to describe the range of deliverables associated with geotechnical work (Sheahan et al., 2016). The FHWA report describes GRDs as “Documents used to communicate geotechnical site conditions, design and construction recommendations to the engineers designing project elements including bridges, roadways, drainage, etc., and construction engineers, and the contractors bidding the work.” These documents take many forms, including: Geotechnical Data Reports, Geotechnical Engineering Reports, Geotechnical Baseline Reports, and Geotechnical Design Memos, emails, among others.”

### **2.1.1 Consultant Work Products**

When GRDs are developed by Consultants for ODOT projects, those documents will be completed under the requirements of this chapter or under a Consultant-specific quality control plan, reviewed and approved by ODOT, which meets or exceeds the requirements of this chapter. The responsibility for QC rests with the Consultant. ODOT responsibilities with respect to Consultant work consist of Quality Assurance (QA). A QA review is not intended to replace the QC responsibilities of the Consultant. Work products that contain demonstrable errors at the time of submission to ODOT will not only need correction but are indicative of a failure in the Consultant’s QC processes and may require deeper, programmatic review and action.

## **2.2 Geotechnical Quality Standards**

A variety of guidance documents exist with respect to geotechnical work completed by and for ODOT. The predominate standard is the ODOT Geotechnical Design Manual which takes precedent over codes such as the AASHTO LRFD Bridge Design Specifications (A.A.S.H.T.O., 2020), and various FHWA design manuals.

“The [ODOT Project Delivery QA/QC Program website](#) provides an overview of the ODOT Project Delivery QA/QC Program, access to the quality standards of practice. The Project Delivery Statewide Quality Management Program Manual can be found there, as well as a listing of the quality plans and guidance documents, including the region Technical Center quality plans, the technical discipline quality plans, and the transportation project management statewide quality plan. There is also a listing of the associated quality forms and checklists.” (ODOT Discipline Quality Template).

### **2.3 Roles and Responsibilities**

The roles and responsibilities for implementing geotechnical quality control throughout the project design and construction are described in this section. Each project team shall consist of four professionals; two Geotechnical Engineers one designated as the POR, and one as the designated reviewer, two Engineering Geologists one designated as the POR, and one as the designated reviewer.

A variety of engineers and geologists as well as technicians and office staff will be involved in the development of GRDs. However, the responsibility for those documents rests, by law (OAR

820-005-0075, 2022), with professionals licensed in the fields of Engineering Geology and Engineering. The Professionals of Record (Engineering Geologists and Geotechnical Engineers) are responsible for acting within their own level of competence and knowledge (OAR 820-020-0020). A professional working outside of their competence is potentially endangering the public and is violating State law (OAR 820-020-0020).

For each project, the QC team shall consist of at least four individuals, the Engineering Geology and Geotechnical Engineering Professionals of Record as well as the Engineering Geology and Geotechnical Engineering Reviewers. The nature and responsibility of each is described below.

**Engineering Geologist Professional of Record (Engineering Geologist POR).** The Engineering Geologist POR on ODOT projects shall be the person in responsible charge for geologic interpretations and decisions made on the project. They will be registered as a Certified Engineering Geologist with the State of Oregon.

**Geotechnical Engineer Professional of Record (Geotechnical Engineer POR).** The Geotechnical Engineer POR on ODOT projects shall be the person in responsible charge for geotechnical decisions made on the project. They will be registered as a Professional Engineer with the State of Oregon and will be especially qualified in Geotechnical Engineering.

**Engineering Geology Reviewer.** The Engineering Geology Reviewer will provide primary technical review for geologic aspects of the project. They will be registered as a Certified Engineering Geologist with the State of Oregon.

**Geotechnical Engineering Reviewer.** The Geotechnical Engineering Reviewer will provide primary technical review for all Geotechnical Engineering aspects of the project. They will be registered with the State of Oregon as a Professional Engineer and will be especially qualified in Geotechnical Engineering.

**ODOT Geology/Geotechnical Supervisor.** Each ODOT region has a supervisor who has direct personnel responsibility over the Geologists and Engineers that work within the Geology/Geotechnical section of that region. Where such individuals are not geo-professionals, they may make use of a lead worker who has the expertise and assists in addressing technical issues.

**ODOT Region Management.** The management team of each ODOT region is ultimately responsible for the management of staff and resources within the region.

**ODOT Headquarters Staff.** Senior Geologists and Engineers are located in the ODOT Technical Services Center in Salem. Those professionals are responsible for standards and policies, including the development of this manual, for geotechnical work throughout ODOT as well as for agency wide QA reviews.

## 2.4 Geotechnical Process

The process described by this section defines the minimum level of communication and collaboration necessary to meet the requirements of the ODOT Geotechnical QC plan. Members of the project team are encouraged to freely communicate throughout the life of the project in

order to assure a high level of service and quality and reduce significant amounts of rework, errors, or omissions.

## 2.4.1 Quality Control Reviews

Quality control reviews are undertaken to assist the POR in developing documents that are free of errors and mistaken assumptions. The reviews are also intended to assure consistency of the documents with applicable standards and guidance and consistency between calculation results and recommendations. Lastly, quality reviews should verify that previous QC review comments have been understood and addressed.

For expediency and consistency, the review of GRDs is assisted by a variety standard templates and checklists. The development and implementation of these templates and checklists is intended to assist designers and reviewers in completing their mission and to provide reminders of applicable guidance and standards. It is important to note that the use of these tools is not intended to replace sound professional judgement nor to relieve the POR from their personal responsibilities.

## 2.4.2 Reviewer Authority

**Reviewer Authority** Most often, the Reviewer and POR will address recommendations and changes in a collaborative manner and create a work product that satisfies both parties. However, situations will arise where that is not tenable. For those cases, guidance is needed to address the authority of Reviewers to require changes in the work products or tasks. The relationship between a reviewer and the licensed professional in responsible charge is also a part of that discussion.

- ODOT has the right, responsibility, and authority to establish the procedures, policies, codes, standards of practice and level of quality under which work products and tasks will be conducted. The only limitation is that practice standards should be no less than the standard of care in the industry.
- All workers, especially licensed professionals, have a duty to complete assigned work in a manner that meets the policies and procedures of their employer. Licensed professionals also have a duty to always protect the safety of the public and to practice within their level of competence and according to the standard of care in the industry. There is no conflict between these duties unless an employer tries to require a licensed professional to do something that exceeds their professional competence and/or endangers the public.
- Recommended changes to the work will generally fall into three categories, those that represent different ways to analyze or view the work that are suggested or advisory, those that represent serious differences of opinion but do not violate the Standard of Care or impact the safety of the public, and those that do violate the Standard of Care or impact the safety of the public.
- Compromise and open-minded communication is crucial. Further, it is the POR's first duty to try and solve the matter with the reviewer. The reviewer should make every possible effort to explain their position to the POR and listen to feedback. Failing

resolution between the parties, the resolution will vary depending on the nature of the dispute.

- For changes requested by the Reviewer that would fall into the first category and would be considered suggestions and feedback, the POR should respond to the reviewer but does not need to document their choice to not incorporate the suggested changes.
- For the second category, serious differences, not violating the Standard of Care or impacting the safety of the public, the POR should respond to each item individually and document why they are not implementing the recommendation. It may be necessary for the reviewer to permanently document their dissent from the decision made.
- For differences that either party (POR or Reviewer) considers to violate the Standard of Care or impact safety of the public and that cannot be resolved, the POR shall work with the Unit Manager and subsequently the Technical Center Manager prior to seeking other ways of resolving the problem.
- Reviewers cannot require licensed professionals to change work in a way that would endanger the public or violate the Standard of Care.
- Licensed professionals will still be expected to seal work products and accept technical responsibility for projects to which mandatory changes have been made by reviewers. Only if the changes jeopardize the safety of the public or violate the Standard of Care would the licensed professional have an argument for not being responsible for sealing the work.

**Disputes.** Differences in engineering opinion exist and it is likely that Reviewers and PORs will find areas of disagreement. On first identifying areas of disagreement, it is incumbent upon the parties to discuss the issue and attempt to come to a solution that is satisfactory to both parties. When an impasse has been reached, the issue will be reviewed by Headquarters geotechnical staff that will be made available to both parties. Ultimately, it may be necessary for one of the parties to recuse themselves from the project.

## 2.5 Glossary

**Quality Control.** - Quality Control consists of the daily processes, practices, and checks in place to control the quality of the engineering works as they are being developed.

**Quality Assurance.** - Quality Assurance is a program undertaken to assure developed work products were completed and documented in accordance with established Quality Control requirements.

**Geotechnical Reporting Documents.** - Geotechnical Reporting Documents (GRDs), as defined by the FHWA, are documents used to communicate geotechnical site conditions, design and construction recommendations to the engineers designing project elements including bridges, roadways, drainage, etc., construction engineers, and the contractors bidding the work (Sheahan et al., 2016).

**Geotechnical Design Manual.** - The Geotechnical Design Manual (GDM), of which this chapter is a part, establishes standard policies and procedures regarding geotechnical work performed for ODOT. The purpose of the GDM is to establish investigation and design standards with the

goal of optimizing design, minimizing over-conservatism as well as under-design. All state of Oregon projects are required to meet the design standards in the GDM.

**Responsible Charge.** - To be in Responsible Charge of work, the **Geotechnical Engineer** or **Engineering Geologist** shall have supervision and control over the work from the inception and will be responsible for engineering or geologic decisions, respectively. Supervision and control means establishing the nature of, directing and guiding the preparation of, and approving the work product and accepting responsibility for the work product. **This includes;** spending time directly supervising the work to assure that the person working under the licensee is familiar with the significant details of the work; providing oversight, inspection, observation and direction regarding the work being performed; providing adequate training for persons rendering services and working on projects under the licensee; maintaining readily accessible contact with the person providing services or performing work by direct proximity or by frequent communication about the services provided or the work performed; and applying the licensee's seal and signature to a document **(OAR 820-005-0075, 2022)**.

**Professional of Record.** - The Professional of Record (POR) is the **Engineering Geologist** or **Geotechnical Engineer** in responsible charge of geology or engineering work for a project.

**Engineering Geologist.** - A professional Geologist holding current Certified Engineering Geologist registration with the Oregon State Board of Geologist Examiners (OSBGE) **(ORS 672.505, 2021)**.

**Geotechnical Engineer.** - A professional Engineer registered as a Professional Engineer with the Oregon State Board of Examiners for Engineering and Land Surveying (OSBEELS), especially qualified in Geotechnical Engineering **(ORS 672.002, OAR 820-040-0040)**.

## 2.6 Geotechnical Documentation

**"As project QC work is done, quality records are created that provide reviewable evidence documenting that quality work was done. These quality records also provide the basis for QA reviews and/or audits (performed by professional auditors)" (ODOT Discipline Quality Template).**

Documentation of the quality control process is necessary to allow for assurance that the QC process was completed per the requirements, and to allow for the subsequent completion of QA. Feedback with respect to the ability of this plan to meet the needs of the Agency can only be received if the process is documented.

Documentation needs to be **synchronized with** the work being completed and must not be postponed to the end of the project. Each stage of documentation should be completed and saved in **ProjectWise** to assure that the QC process was completed in a timely manner and was being implemented throughout the project life rather than hastily assembled at close-out.

Table 2-1 lists all the documents required for review by the QC team, the basis for the document, and what type of endorsement with date is necessary. As previously discussed, the official project file including all the documents listed in Table 2-1, are saved in the ProjectWise project folder. Much of the review documentation is completed with the **Geotechnical**

Engineering and Engineering Geology Quality Control, ODOT forms 734-5199 and 734-5200, respectively.

The reviewer signing the work product will be one who conducted the review to identify mistakes, oversights or logic errors. The reviewer does not stamp the work unless he or she was in responsible charge of some discrete portion of the project. A reviewer in responsible charge of the work would sign as a co-author and not as a reviewer.

All other reviewed work products or tasks will be documented in the project file. A separate sheet attached to the file will list the items for review and provide for recording an initial and a date from the reviewer indicating that the review has been accomplished.

Reviewer’s comments and notes should be in writing to the greatest extent possible to promote good communication, provide documentation, and minimize misunderstandings. However, to the maximum extent possible, all reviews should be presented verbally to the PORs. This maintains the congenial and professional relationships that helps to ease whatever technical disagreements that may arise. The reviewer’s comments are retained in ProjectWise.

Electronic file saving allows for significant time and effort savings with respect to documentation. ODOT will rely heavily on ProjectWise to document the QC process. The POR is responsible for verifying that all required QC documentation is stored in appropriate locations in ProjectWise.

“Quality records in ProjectWise are stored in their regular discipline or milestone directory, with either “QC” or “QA” in the document title or description, to facilitate searches for quality documentation. A set of quality files from each discipline or milestone folder in ProjectWise will be created in the ProjectWise “7\_quality” folder. The set naming convention will use the discipline code (TD) as follows:

*TD\_K#####\_##* (ODOT Discipline Quality Template).

**Table 2-1 Geotechnical Deliverables Documentation Quality Control Requirements**

<b>Phase</b>	<b>Document</b>	<b>Basis of Requirement</b>	<b>Document</b>	<b>Endorsement</b>
<b>Scoping</b>	Scoping Notes	Project Delivery Guidance	Scoping Notes	Initial and date
<b>Kickoff</b>	Geologic and Geotechnical Scope of Work	Project Delivery Guidance	734-5199 & 734-5200,	Name & date
<b>DAP</b>	Initial Site Visit & Reconnaissance Memo	GDM	734-5200	Name & date, Name & date
	Exploration Program/Plan	GDM	734-5199 & 734-5200,	Name & date Name & date
	Laboratory Program/Plan	GDM	734-5199 & 734-5200	Name & date Name & date

<b>Phase</b>	<b>Document</b>	<b>Basis of Requirement</b>	<b>Document</b>	<b>Endorsement</b>
	Field Explorations and Draft Logs	GDM	gINT Template	Initial and date
	Final Geologic Models	GDM	734-5200	Name & date
	95% Geology Report	GDM	734-5200	Name & date
	95% Geotechnical Data Sheets	GDM	734-5200	Name & date
	Analysis/Design	GDM	Calc Book	Initial and date
	Material Source/Disposal Site Concepts	GDM	734-5200	Name & date
	Geotechnical Memo	GDM	734-5199	Name & date
	Design Deviation Request	GDM	734-5199, 734-5200	Name & date, Name & date
	Draft DAP Plans and Estimates	Project Delivery Guidance	Plans, Estimates	Initial and date
	Final DAP Plans and Estimates	GDM	Plans, Estimates	Initial and date
<b>Preliminary</b>	Geotechnical Report	GDM	Geotechnical Report, 734-5199, 734-5200	Signature & date, Name & date, Name & date
	Final Geotechnical Data Sheets	GDM	Final GDS, 734-5200	Name & date, Name & date
	Preliminary Material Source/Disposal Site Plans and Estimates	GDM	734-5200	Name & date
	Preliminary Geotechnical Plans and Estimates	Project Delivery Guidance	Plans, Estimates	Initial and date
<b>Advanced Plans</b>	Geotechnical Report	GDM	Geotechnical Report, 734-5199, 734-5200	Initial and date,
	Advanced Geotechnical Plans and Estimates	Project Delivery Guidance	734-5199, 734-5200	Name & date, Name & date
	Advanced Special Provisions	Project Delivery Guidance	734-5199, 734-5200	Name & date, Name & date
	Advanced Material Source/Disposal Site Plans	GDM	Plans, 734-5199	Name & date, Name & date

<b>Phase</b>	<b>Document</b>	<b>Basis of Requirement</b>	<b>Document</b>	<b>Endorsement</b>
<b>Final Plans</b>	Geotechnical Report Addenda	GDM	Addenda	Initial and date
	Final Geotechnical Plans and Estimates	Project Delivery Guidance	Plans, Estimate,	Initial and date
	Final Special Provisions	Project Delivery Guidance	Special Provisions	Initial and date
<b>PS&amp;E</b>	Geotechnical Reporting Documents Addenda	GDM	Addenda, 734-5199, 734-5200	Initial and date,
<b>Construction</b>	Significant Project Changes	GDM	Plans, special provisions	Initial and date

Regardless of the documentation type, each deliverable will be stored in ProjectWise with electronically signed documentation confirming that a thorough QC review has been completed at the time of production. Each electronic signature or initial should be considered a valid secure signature with no errors. The electronic signatures will include at least the name and date the document was signed. A hard copy with wet signature may be used to provide additional information, but at least an electronic document with electronic signature should be included in the project file in order to track timelines.

In the event of a minor or moderate technical disagreement between reviewer and designer, the parties may select to write a short justification and include with the electronic documentation. If there is a major technical disagreement, the issue should be elevated to appropriate staff consistent with the previously stated policies. Stylistic differences do not need to be officially documented.

To the extent reasonable, unsealed drafts of professional deliverables should be retained within the ProjectWise project file. Electronic version control should be in accordance with file naming convention detailed elsewhere in this manual. Drafts should be retained in the ProjectWise project file.

## **2.7 Project Phases**

The ODOT project delivery process, as it relates to geotechnical services, is detailed in a timeline/swimlane table included as Appendix A of this chapter. The timeline shows the interrelationships of the responsible parties as well as the typical deadlines for deliverables.

For clarity, the ODOT project delivery process has been broken down into a series of milestones or phases. The following sections detail the nature of each deliverable as well as the assumed process associated with production.



## **2.7.1 Scoping Notes**

Scoping is completed in order to identify which projects will be programmed into a future STIP. At scoping, subject matter experts (including Engineering Geologists and/or Geotechnical Engineers) review the business case (purpose & need) for a proposed project, as provided by the Program Manager, and identify the project elements required to meet the purpose & need, and draft “scoping level” estimates. This review frequently includes a site visit. Scoping teams draft scoping notes outlining project elements and risks by discipline. Scoping teams also provide cost estimates to establish the budget required to deliver the complete project. These estimates have a large contingency and are typically based on average historic bid item prices.

Geo-professionals, Engineering Geologists and Geotechnical Engineers, should participate in all scoping efforts. If a project is determined to have no Geologic or Geotechnical elements based on the existing business case, then the geo-professional should document this in the scoping notes (and the scoping notes will be short). It should be the responsibility of the geo-professional to assess the project and determine whether there are Geologic or Geotechnical elements, rather than the Program Manager or Project Leader.

The geo-professional assigned by the Region to assist in scoping will produce Scoping Notes and a Scoping Estimate. The notes need to clearly outline known Geologic and Geotechnical elements (retaining walls, bridge foundations, rockfall mitigation) and risks associated with unknowns (mitigating liquefaction, need for sound walls, foundation type based on soil conditions), as well as proposed methods for reducing risk during the project. The Scoping Estimate includes a cost estimate for design and a summary of resource needs.

## **2.7.2 Initial Site Visit/Reconnaissance Memo**

The purpose of the initial site visit is to observe existing conditions of the site, evaluate performance of existing slopes/structures, identify errors or omissions in existing data (survey, layout, etc.), locate utilities, strategize logistics for exploration and note any discrepancies with the scope.

A site visit by the Professionals of Record is essential. However, the Reviewers should also attend the site visit to concur with the POR’s observations and provide a second set of eyes which may observe different conditions or identify issues that the POR does not observe.

After the completion of the initial site visit, the Engineering Geology or Geotechnical Engineering POR should create a written summary with applicable sketches and photographs. This document does not need to be a formal memo but needs to be complete with respect to what was observed in the field and may be incorporated into the Exploration Plan. The initial site visit summary should be reviewed by the project Engineering Geology and Geotechnical Engineering Reviewers.

## **2.7.3 Exploration Program/Plan**

The Exploration Plan is intended to document the agreed upon strategies for geotechnical exploration at any phase of a project between the Engineering Geologist POR, and the

Geotechnical Engineer POR. The Exploration Plan is created prior to field exploration taking place, and should be a communication tool for the field staff, drillers, the Project Leader, and managers involved in resourcing, scheduling, and financing the exploration. The Exploration Plan must be flexible, as changes are very likely to occur (and even encouraged) during the course of field explorations when actual field data is obtained. Additionally, the assumptions made during creation of the Exploration Plan may change, and the PORs may determine that more or less may be needed from the field exploration. Good communications between the field personnel and the PORs is key while explorations are conducted.

Guidance on the development of the exploration plan is included in [Chapter 4](#) of this manual, including a template for use on ODOT projects. As a minimum, the Exploration Plan should contain a listing of the proposed **number and type of** explorations tabulated along with estimated sampling and footage of drilling types (Auger, Core, etc.), **as well as the proposed instrumentation types and depths of installation**. Exploration plans should have included a site map with the features to be explored along with the holes superimposed on that location.

**Responsibilities.** Perhaps more than any other element of a geotechnical project, the development of the exploration plan requires the collaborative involvement of Geologists and Engineers. For that reason, the typical roles of the project geo-professionals are described below.

**The Engineering Geologist POR** is ultimately responsible for the characterizing the geologic conditions pertinent to the project at the site. They are therefore responsible for directing the field exploration to obtain geologic data and engineering data needed to complete that characterization and to allow for the project design. Therefore, the Engineering Geologist POR is the owner of the Exploration Plan, and will typically be the one to direct changes to the Exploration Plan while field work is occurring.

**The Geotechnical Engineer POR** is responsible for anticipating needs for analysis and design prior to field explorations, and clearly communicating the requirements for field data to the Engineering Geologist. The Geotechnical Engineer will typically provide information that helps determine the location, depth and spacing of drill holes as well as the specific needs for field samples, testing, groundwater, and any monitoring requirements for long term studies. It is therefore critical that the geotechnical engineer be fully engaged in development of the Exploration Plan, and has confidence that the field explorations will provide the required data. During the course of field explorations, the geotechnical engineer will remain fully engaged to ensure that assumptions made during creation of the Exploration Plan are correct. If it becomes apparent that changes to the Exploration Plan may be needed, then requested changes are communicated to the engineering geologist.

**The Engineering Geologist Reviewer** is responsible for understanding the goals of the project and the requirements from the geotechnical engineer POR. The Exploration Plan is then reviewed to see if it is likely to deliver the requirements to characterize the geologic conditions for the project. The Engineering Geologist reviewer typically discusses the Exploration Plan with the Engineering Geologist POR in order to gain good understanding of the goals and objectives of the Exploration Plan, then documents the review.

The **Geotechnical Engineer Reviewer** is responsible for understanding the goals of the project and the data requirements from the geotechnical engineer POR. The Geotechnical Engineer reviewer typically reviews the data requirements with the Geotechnical Engineer POR to help ensure that the data requirements are complete and sufficient. The Exploration Plan is then reviewed to see if it is likely to deliver the data required for analysis and design. That review is also documented.

## 2.7.4 Laboratory Program/Plan And Sample Selection

The Geologist and Engineer PORs should jointly determine the laboratory tests needed for the project elements as exploration proceeds. Samples should be submitted for testing as soon as possible after retrieval from the field so that any unusual results can be further evaluated by submittal of additional samples, and to avoid a backlog of work at the lab.

Guidance on the development of the Laboratory Plan is included in [Chapter 3](#) of this manual, including a template for use on ODOT projects.

Classification and logging of soil and rock is addressed by [Chapter 5](#) of this manual and the ODOT Soil and Rock Classification Manual. In completing the initial soil classification, a check-classifier is assigned to the project to provide verification of the initial classification. The Check-Classified must be a geologist or engineer familiar with the project and trained in soil classification.

The typical process for completing the laboratory plan is summarized below:

- Check-classifier assigned by Engineering Geologist POR
- Check-classifications performed
- Significant discrepancies between the Engineering Geologist POR classifications and check classifications are typically resolved by additional laboratory testing
- Geologist properly labels all containers to be sent to the lab
- Engineering Geologist and Engineer PORs develop laboratory plan
  - Determine critical areas for testing
  - Complete sample inventory
    - Verify that undisturbed samples were taken in fine-grained soils
  - Assure that critical areas have been adequately sampled
  - Verify field tests (Torvane, Pocket Penetrometer)
  - Develop testing parameters
  - Include special testing instructions on the Sample Data Form
- Engineering Geologist POR verifies that representative tests are to be performed in all of the potential engineering geologic units encountered
- Undisturbed samples are stored and shipped upright and isolated from vibrations or jarring

The Engineering Geologist POR and Geotechnical Engineer POR review the results of the laboratory testing to assure that all requested tests were completed according to their requirements and that the results are consistent with their expected material properties. Additional testing may be necessary if questionable or surprising results are obtained.

## 2.7.5 Field Explorations And Draft Drill Logs

The completion of field explorations and development of draft drill logs are covered in depth in [Chapter 4](#) and [Chapter 5](#) of this manual. Final exploration logs are one of the products of a site characterization for project design. They represent the culmination of a lengthy process that starts with the siting of exploration points and ends with an evaluation of materials in the context of the engineering geologic characteristics of the project area. The final logs are comprised of a description of the engineering geologic units encountered with or without the individual sample descriptions and classifications.

The process of drill log production takes place in three general phases. Field logging includes the collection and description of samples at the exploration site. Office evaluation, check classification, and laboratory testing is the second phase. The final phase is the incorporation of laboratory testing and correction of sample classification and description based on these results, and the subsequent modification of the unit descriptions. The unit descriptions may be further modified during creation of the subsurface model.

**Field Phase.** The primary roles of the field geologist or engineer consist of recording exploration activities on the standard form, collecting samples in accurately labeled receptacles, transporting samples to the office or laboratory, and description of samples according to the ODOT Soil and Rock Classification Manual. The field geologist is responsible for entering the field log into the gINT program. This is an essential QC step for the field geologist to assure that descriptions are complete, appropriately entered, and match their initial field interpretation.

Throughout the field exploration process, the **relevant** staff should be aware of the expense involved in mobilizing exploration equipment and therefore the need to extract the maximum value possible from each field effort. In particular, oversampling generally results in a modest additional cost while remobilizing to address gaps in sampling results in very high additional costs.

It is critical that field staff communicate preliminary results on timely basis with the PORs. The conditions encountered and samples collected should be discussed with the PORs in real time, to the extent possible. This is particularly true for situations where the conditions encountered in the field differ materially from those anticipated and discussed prior to beginning field activities.

In general, these activities are under the direction of the Engineering Geologist POR in consultation with the Geotechnical Engineer POR.

**Office Laboratory Phase.** The process for developing and implementing the laboratory testing program as well as check classification are discussed in the previous section of this manual.

**Analysis and Finalization Phase.** Once complete, the laboratory test results are entered into the gINT program for inclusion on the exploration log, where appropriate. The laboratory results are used to refine sample descriptions which then necessitate adjustments to the engineering geologic units. Typically, this would consist of simple refinements of the descriptions and classifications. Adjustments to the units themselves may be needed if the lab test results require it. As the Engineering Geologist POR compiles the logs in this iteration, the engineering

geologic units in the individual borings are complete enough to construct a preliminary or intermediate geologic model of the site. The Engineering Geologist POR should review the relationships between explorations in the model. Where necessary, adjustments to the units may take place based on stratigraphic position, material properties, or other engineering geologic considerations. Finally, the Geotechnical Engineer POR and Engineering Geologist POR review the subsurface model together to consider any final adjustments to support engineering analysis.

## **2.7.6 Geology Summary**

The Geology Summary would typically consist of the first 12 Sections of the Geotechnical Design Report. For projects where the design team deems it prudent, the Geology Summary may be produced as a fully executed memo or report. In either case, the document will be reviewed by the Engineering Geologist Reviewer. The report should be considered “final” by the POR and Reviewer and should be ready to present to the report users for their review and comment.

The Geology Summary is prepared by, or under the direct supervision of, the Engineering Geologist POR assigned to the project. The Engineering Geologist POR should maintain close communication with the Geotechnical Engineer POR to ensure that the required information is provided. The format and contents are discussed in detail in [Chapter 4](#) of this manual. Typically the Geology Summary should include, but is not limited to the following:

- Project Description
- Summary of Surface Conditions
- Regional and Site Geology
- Regional and Site Seismicity
- Summary of Office Studies
- Summary of Field Exploration
- Summary of Laboratory Testing
- Soil and Rock Materials and Subsurface Conditions
- Subsurface Profiles
- Geotechnical Data Sheets
- Surface hydrology and subsurface hydrogeologic conditions
- Summary of Geologic Hazards
- Engineering Geologic Recommendations
- Appendices

The information to be presented in the Geology Summary should be discussed with the Reviewer and agreed to prior to and during preparation. A draft document should be submitted to the Engineering Geologist Reviewer for review and comment prior to publication with an agreed-upon lead-time.

The Engineering Geologist Reviewer is responsible for maintaining close communication with the POR and understanding the project area and proposed project features. The Reviewer should corroborate any identified geologic hazards, the regional and site geology and the regional and site seismicity. The Reviewer should also perform independent checks of the soil

and rock material classifications. Upon receipt of the draft, the Reviewer should review all aspects of the report for accuracy, overall presentation, and conformance with ODOT standards and return any comments within the agreed to timeframe.

Generally, the content of the Geotechnical Memo is developed utilizing information contained in the Geology Summary. In order to complete the Geotechnical Memo in sufficient time for submittal during DAP, it is crucial that the Geology Summary be completed as soon as practical after completion of the borings and laboratory program. The deliverable date for the Geology Summary should be discussed and agreed to at the geotechnical kick off meeting.

### **2.7.7 Draft Geotechnical Data Sheets**

At this point in the project, the Geotechnical Data Sheets should be prepared in draft form with the information available.

### **2.7.8 Analysis And Design**

The review of analysis and design, including calculations, presents a number of challenges with respect to well documented QC. Most significant is that this work is often continuous and spans numerous milestones. Further, the review of preliminary calculations may be important since a critical early error will compound through later work. Lastly, calculations are completed by staff at multiple levels and backgrounds, ranging from quite inexperienced to the most senior staff. Calculations need technical review by a competent individual other than the person completing the calculations. These reviews need to occur at both a preliminary and a final level.

Calculation review includes contemporaneous preliminary review and final review.

Preliminary Review is completed at the time of the calculations and is completed for each phase/round of calculation.

- If calculations are completed by a junior staff, contemporaneous preliminary review will be by the POR.
- If calculations are completed by the POR, review can be by the assigned Reviewer.

At the preliminary stage, review only need constitute the “second set of eyes.” As such, the reviewer need not be more senior but must be trained in the appropriate discipline and capable of completing the review.

Preliminary reviews will be documented by a simple initial or checkmark system on physical calculations, electronic initials on electronic documents.

At each reporting milestone, final review of all calculations completed to date will be made by both the POR and the Senior Reviewer. The final review at each stage will result in a signed calculation cover sheet as well as marked up calculations.

Calculation review would include checking each parameter used whether measured or assumed, methodology used, and outcome. For software based calculations, the complete input and output files should be reviewed. Note that review of spreadsheets requires access to the original spreadsheet in order to verify all formulas and calculations. For this reason, the use of spreadsheets for calculations is discouraged. Math Cad or similar programs are preferred for

electronic calculations as they facilitate the review of the actual embedded formulas. The exception would be spreadsheets that have been developed at ODOT and that have undergone a rigorous QC process.

The final documentation of calculations will consist of a compiled calc book that will include electronic copies (scans where necessary) of all calculations relevant to final design. The calc book will be reviewed and signed by the applicable PORs and Reviewers.

## 2.7.9 Geotechnical Memo

Preliminary Geotechnical Reports may be prepared for larger, more complex projects but are not standard for all projects. For most projects, preliminary recommendations are more appropriately conveyed via a simple memo. Regardless of the level of detail, the primary purpose of preliminary geotechnical documents is to support the Bridge and Roadway designers in preparation of the TS&L Report and to be included in the DAP submittal. Since the preliminary documentation is typically presented in memo form, this manual uses the term Geotechnical Memo in spite of the fact that this document could be a fully executed geotechnical report.

A Geotechnical Memo is typically finalized 75 percent of the way through the DAP timeline. At this stage, a geological reconnaissance of the project site has usually been conducted and the subsurface exploration program is complete. Draft gINT drill logs should be available and some preliminary geotechnical analysis can be performed to characterize key elements of the design, assess potential hazards, evaluate potential design alternatives and estimate preliminary costs.

**Roles and Responsibilities.** The Geotechnical Memo is prepared by the Geotechnical Engineer POR assigned to the project. The POR should maintain close communication with the Bridge, Hydraulic and Roadway designers, as well as the Geotechnical Engineer Reviewer, to ensure that the required information is provided. Typically the Geotechnical Memo includes a brief description of the proposed project, the anticipated subsurface conditions (based on existing geologic knowledge of the site, as-built plans and records and other existing information), and presents preliminary foundation design recommendations such as foundation types and approximate geometry. The rationale for selecting the recommended foundation type should be presented. The potential for liquefaction and associated effects should also be discussed as well as any other geologic hazards that may affect design.

The information to be presented in the Geotechnical Memo should be discussed with the reviewer and agreed to prior to preparation. A draft of the Geotechnical Memo should be submitted to the Geotechnical Engineer Reviewer for review and comment prior to publication with an agreed-upon lead-time.

The Geotechnical Engineer Reviewer is responsible for maintaining close communication with the POR and understanding the project goals and proposed features. The Reviewer should review the draft for accuracy, perform independent checks on any geometry provided, and return any comments within the agreed-upon timeframe.

The recommendations included in the Geotechnical Memo are generally preliminary and may include numbers, such as bearing capacities, which could change after subsequent analysis and

design. The preliminary nature of the recommendations should be explicitly discussed in the Geotechnical Memo so as to allow other members of the design team to use them appropriately.

## **2.7.10 Design Deviation Request**

As the layout of the project progresses, there may arise situations where deviations from the requirements of the GDM and/or AASHTO guidance are necessary in order to complete the project. Those situations will require the submission and approval of a Geotechnical Design Deviation Request. The deviation approval process takes time and as such, the deviation request should be submitted as soon as possible after the need for approval is identified. Deviation requests should be prepared with the involvement of the Geology and Geotechnical PORs and should be reviewed by the Geology and Geotechnical Reviewers prior to submission.

## **2.7.11 Geotechnical Report**

Throughout the Preliminary Phase, Draft Plan Sheets (Wall Sheets and Geotech Data Sheets) are prepared and submitted to the project team.

The most significant deliverable during this time would be a geotechnical report (GTR). The report should be complete and contain final recommendations (based on the project details available at the time of publication). Elements of a GTR should, as a minimum, include the following.

- Project Description
- Summary of Surface Conditions
- Regional and Site Geology
- Regional and Site Seismicity
- Summary of Office Studies
- Summary of Field Exploration
- Summary of Laboratory Testing
- Soil and Rock Materials and Subsurface Conditions
- Subsurface Profiles
- Geotechnical Data Sheets
- Surface hydrology and subsurface hydrogeological conditions
- Summary of Geologic and Geotechnical Hazards
- Analysis of Unstable Slopes
- Recommendations for Stabilization of Unstable Slopes
- Earthwork Recommendations
- Recommendations for stable cut and fill slopes
- Settlement estimates for proposed embankments
- Techniques to mitigate settlements (if necessary) including lightweight fill and/or preloading/surcharging
- Rock Slope and Rock Excavation Recommendations
- Bridge and Other Structure Recommendations
- Seismic Design Parameters and Recommendations
- Summary of Liquefaction Analysis



- Retaining Wall and Reinforced Slope Recommendations
- Traffic Structure, Soundwall and Building Recommendations
- Recommendations for Infiltration/Detention Facilities
- Recommendations for Non-Standard Foundation Designs
- Long-Term Construction Monitoring Needs
- Construction Issues and Recommendations
- Appendices

Detailed guidance on the development of the GTR is included in [Chapter 4](#) of this manual, including a template for use on ODOT projects.

### **2.7.12 Special Provisions**

Geology and geotechnical professionals are frequently responsible for the development of special provisions that relate to earthwork, foundations, retaining walls, and material sources. Regardless of who is responsible for creating these deliverables, the geology and geotechnical PORs and Reviewers should be involved and should be afforded the opportunity to review and approve the special provisions.

### **2.7.13 Geotechnical Report And Complete Plans And Specifications**

Plans, special provisions, and estimates that are within the purview of geotechnical engineering or engineering geology are issued during the Final Plans Phase.

### **2.7.14 Edits To Geotechnical Report By Addenda**

In general, the final GTR should not be edited. Significant changes to the project scope or details may require a reissued report but for most projects, information issues subsequent to the completion of the GTR should be by addenda. Addenda that modify or expand geologic or engineering recommendations should be treated in the same manner as the final report and should be reviewed by the appropriate professional reviewer.

### **2.7.15 Geo Contributions To PS&E**

During the PS&E phase, the geotechnical team may be called upon to provide additional recommendations and/or addenda to the GTR as well as make edits to the plans and special provisions. As with original documentation, modifications to recommendations should be reviewed and documented by the entire team.

### **2.7.16 Significant Project Changes After PS&E**

As previously noted, changes issued after the final report has been sealed should generally be addressed through addenda rather than reissuing the report. Changes that modify or expand the geologic or engineering recommendations should be treated in the same manner as the final report and should be reviewed by the appropriate professional Reviewer.

## 2.8 Quality Assurance

Quality Assurance (QA) is a system to maximize the effectiveness of the QC procedures. The QA process will assist in measuring the effectiveness of the QC efforts in order to provide input into continuous improvement of the work, assist in identifying technical development needs, and consistency with Agency products.

**Competency Building.** The QA process will assist in developing an agency-wide vision of the current needs with respect to technical knowledge and competence. The evaluation of where projects succeed or fail, and the role of the QC program in assuring success will provide data to be used in identifying gaps or weaknesses within the current knowledge base.

**Continuous Improvement.** Beyond project specific compliance, the QA process supports continuous improvement within both the QC program as well as within the practice community providing geotechnical services for ODOT projects.

### 2.8.1 Quality Assurance Process

In order to achieve the goals stated above, the QA process will need to be objective, transparent, and effectively communicated. Two types of reviews will be conducted, a completeness review and a project review.

**Completeness Review.** Initial information on completed projects will be gathered from ProjectWise and DocExpress. The QA team will complete an initial review and evaluation, focused on the completeness and timeliness of the QC documentation and will write up their findings and recommendations in a draft version of a short, project-specific report. The draft report will be provided to the POR and their direct supervisor. The POR will provide the QA team with any applicable clarification or additional information available, which will be incorporated in the final completeness review.

**Project Review.** An in-depth review of the project documentation will address how well the project met standards and the extent to which the QC process contributed to the success of the project. The results of the in-depth reviews will be collected and evaluated for inclusion in an annual summary report.

The completeness review is conducted by a permanent QA team which consists of the State Geotechnical Engineer, an Engineering Geologist, and a Geotechnical Engineer from the GEEG Section. The project review is conducted by the permanent QA team along with two regional representatives, one Geotechnical Engineer and one Engineering Geologist. The regional representatives will be selected by the three permanent members to ensure an independent review is conducted.

In general, projects selected for review by the permanent members of the QA team will be selected by one of the following ways:

- When challenges or problems occur during construction.
- By request from the Regions. A region may, based on concerns or known project issues, request a QA review on any project.

- Randomly. Projects from throughout the regions will be selected randomly for QA review.
- By size. Any project with over \$200k in Geotechnical PE costs will be subject to QA review.

**Summary Report.** The results from both the Completeness and Project Reviews will be collected and summarized in an annual report. That report will not present specific projects but rather an analysis of issues and trends with respect to quality control and project success. The report will contain generalized findings and recommendations. The report will be presented to the **Geo-Management, Geo-Staff, and the Quality Program Manager.**

## 2.9 References

Officials, A. A. S. H.T.O. (2020). AASHTO LRFD Bridge Design Specifications, 9th Edition. In (pp. 1914). Washington, DC: AASHTO.

Peltz, T. R., Mohny, C., Ortiz, S. C., Frost, R., Collins, J., Anderson, S., & Albright, S. (2018). *Implementation of FHWA Geo-Professional Program Review.*

Rogers, T., & Siel, B. (2018). *Oregon Department of Transportation Geo-Professional Program Review.*

Sheahan, J., Zdinak, A., & DiMaggio, J. (2016). Assuring Quality in Geotechnical Reporting Documents. *Geotechnical Engineering Circular, 14*(FHWA-HIF-17-016).

# Appendix 2-A Geo Project Development Process through Scoping

9.28.2018

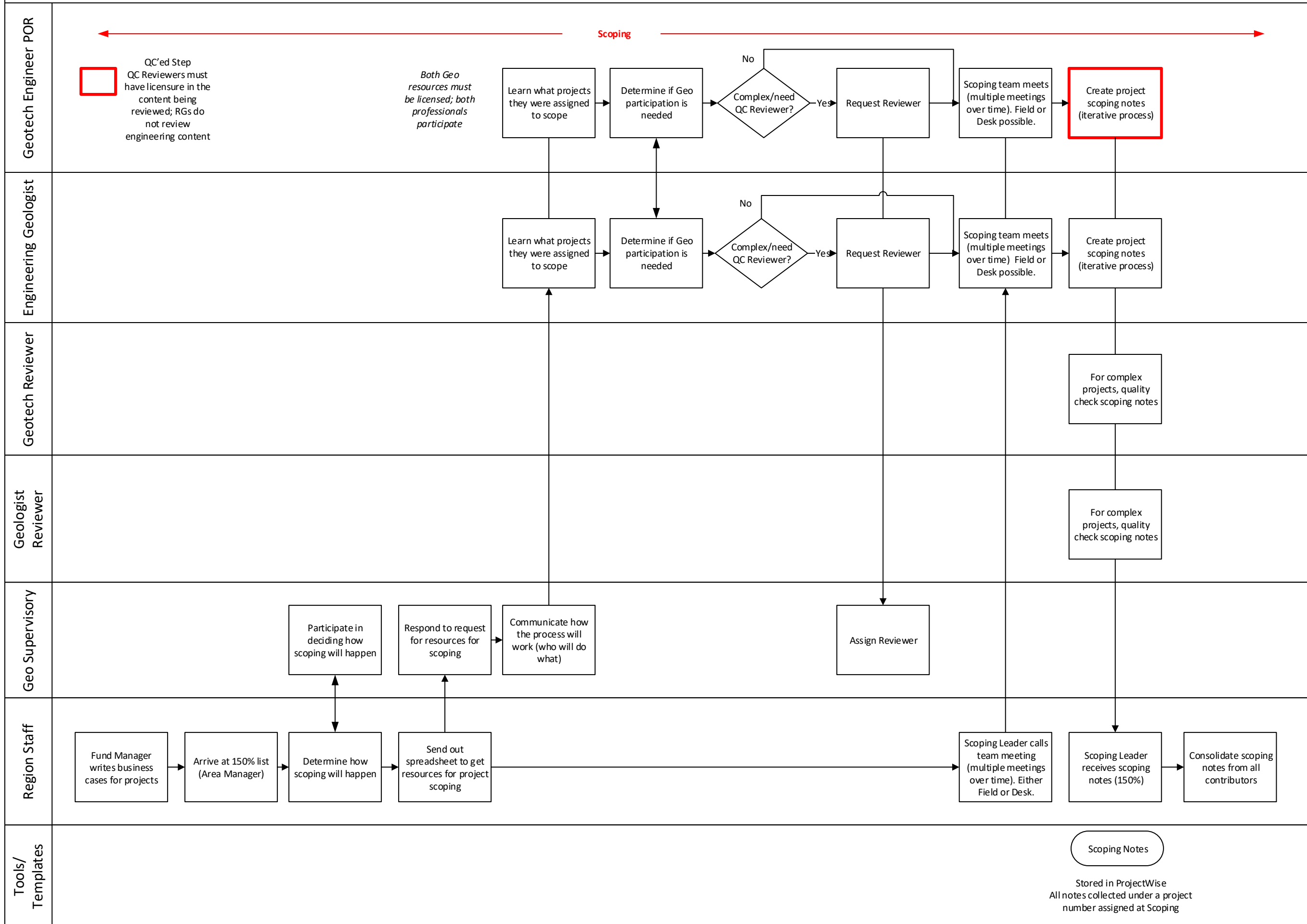

Appendix 2-B Geo Project Development Process

11.16.2018



**Notes**

- Need to include communications with Geo team if budget or schedule changes occur (or if they may change)
- Document also referred to as "Table of Contents." Goes into ProjectWise. Establishes the QC Checklist. Sets up the Calc Book. Sets expectations for how QC will be conducted (who, what).
- Two Master Checklists: Geology QC Master Checklist and Geo Tech QC Master Checklist
- Document goes into ProjectWise
- Document goes into ProjectWise, signed and dated
- Document goes into ProjectWise, signed and dated
- Reviewer signs, in files, internal for Geo
- Originator and reviewer must reach agreement and document their concurrence in each milestone for Calc Book (template)
- Calc Book needs to establish software as the standard (not Excel, unless Proof Line is used)
- Reviewer signed, in file for use by team
- Stamped
- Checklist to include cost estimate
- Use addenda to document any late changes
- Updated costs, preliminary plans, specifications are put into Preliminary Plans Folder in ProjectWise
- Assumption: Comment Log is maintained for Project Team (not by each specific discipline), and updated through all phases

# Appendix 2-C Geo Program Process: Construction

9.28.2018

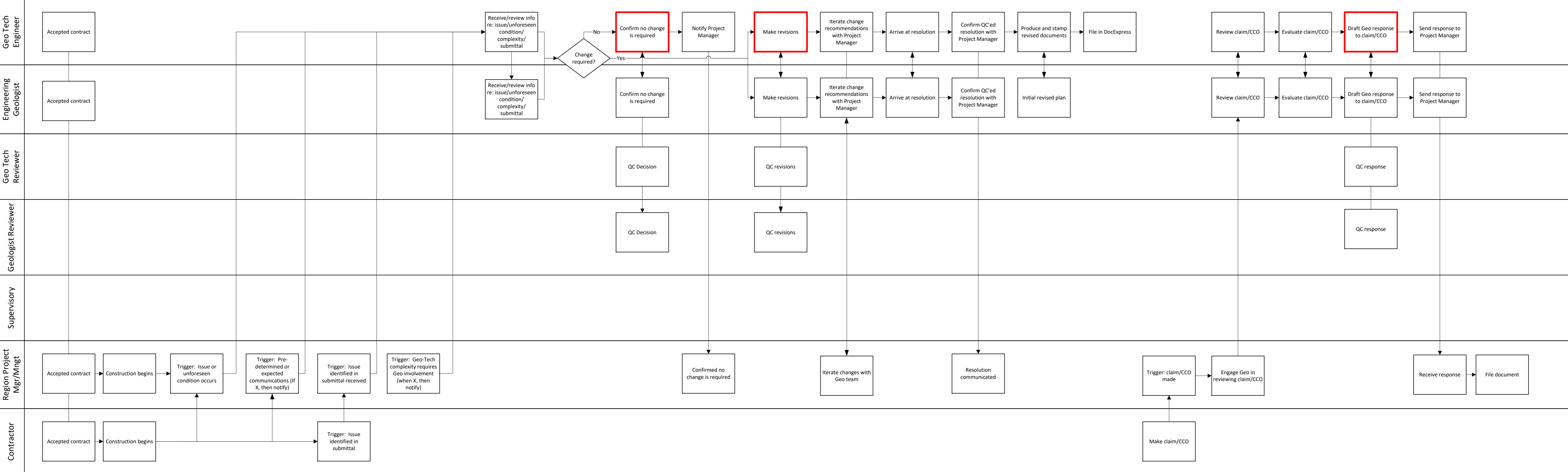

Appendix 2-D Quality Assurance

9.28.2018

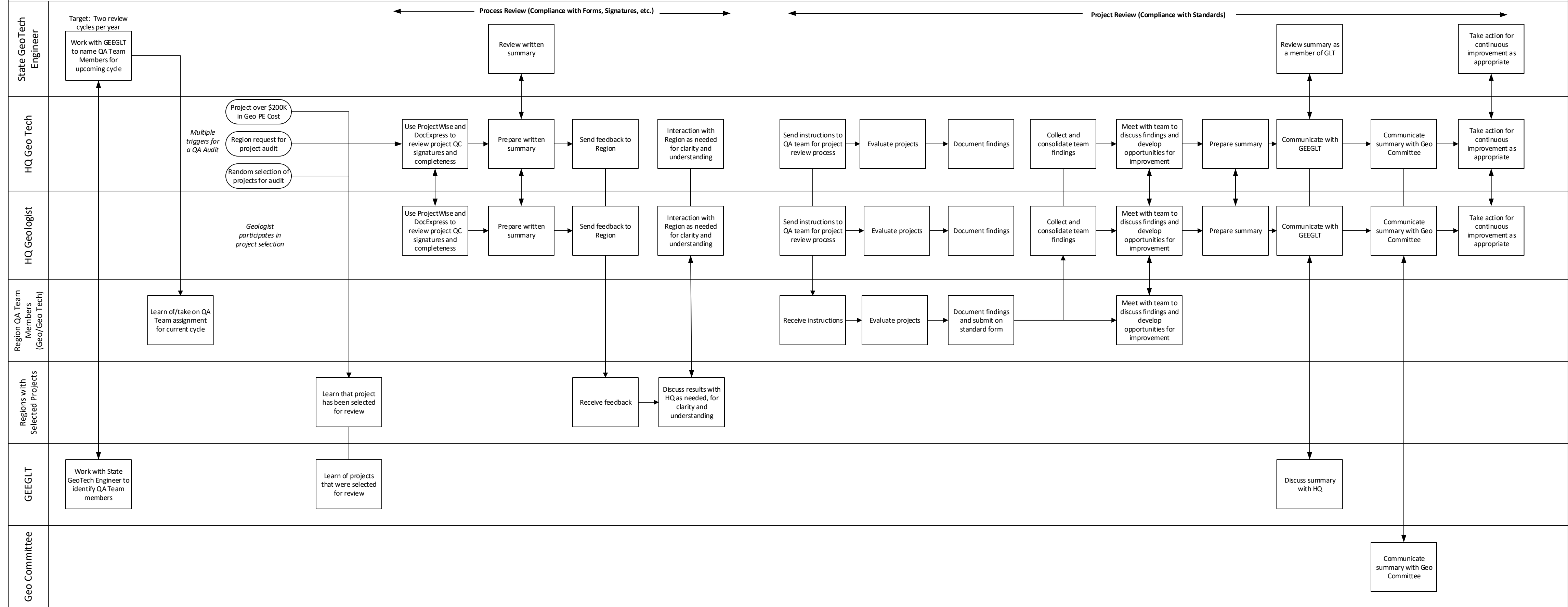

# Chapter 3 - Project Geotechnical Planning



## Chapter Contents

<b>Chapter 3 - Project Geotechnical Planning</b> .....	<b>3-1</b>
3.1 General.....	3-3
3.1.1 Geotechnical Project Elements.....	3-3
3.1.2 Geotechnical Project Tasks and Workflow .....	3-4
3.2 Preliminary Project Planning.....	3-4
3.2.1 General.....	3-4
3.2.2 Office Research .....	3-6
3.2.3 Site Reconnaissance.....	3-19
3.3 References .....	3-23
Appendix 3-A Geology / Geotechnical QC MATRIX .....	3-24
Appendix 3-B OLD ROADWAY AND GEO-HYDRO SECTION FILE RETRIEVAL.....	3-41
Appendix 3-C Bridge Section File Archive Retrieval.....	3-42

## List of Tables

Table 3-1 Geology / Geotechnical Matrix Checklist QC Check #1 – Scoping .....	3-24
Table 3-2 Geology / Geotechnical Matrix Checklist QC Check #2 – Scope of Work.....	3-25
Table 3-3 Geology / Geotechnical Matrix Checklist QC Check # 3 – EIS .....	3-26
Table 3-4 Geology / Geotechnical Matrix Checklist QC Check # 4 – Concept.....	3-27
Table 3-5 Geology / Geotechnical Matrix Checklist QC Check #5 – Exploration Plan.....	3-28



Table 3-6 Geology / Geotechnical Matrix Checklist QC Check #6 – 2/3 TS&L..... 3–29  
Table 3-7 Geology / Geotechnical Matrix Checklist QC Check #7 – Preliminary Plans..... 3–36  
Table 3-8 Geology / Geotechnical Matrix Checklist QC Check #8 – Advanced Plans..... 3–39  
Table 3-9 Geology / Geotechnical Matrix Checklist QC Check #9 – Final Plans..... 3–40

## 3.1 General

This chapter addresses general geotechnical planning for projects with significant grading, earthworks, and structure foundations, from the earliest project concept plan through final project design. Detailed geotechnical exploration and testing requirements for individual design are covered in detail in [Chapter 4](#), [Chapter 5](#), and [Chapter 6](#). This chapter also provides direction for geotechnical project definition and reconnaissance or preliminary studies. Preliminary field and office study is an essential component of the subsurface exploration plan described in [Chapter 3](#). General guidelines for subsurface investigations are also provided in [Chapter 4](#) in addition to specific guidelines regarding the number and types of explorations for project design of specific geotechnical features.

The success of a project is directly related to the early involvement of the geotechnical designers in the design process. For larger projects that involve an Environmental Impact Statement (EIS), the geotechnical designer needs to be involved with the assessment of various options or corridor selections. Ideally, for all projects, the geotechnical designer will be involved during the first project scoping efforts. At this point, a study of the project concept is begun by gathering all existing site data and determining the critical features of the project. This information can then be presented at the project kick-off meeting and/or scoping trip. The project-scoping trip is a valuable opportunity to introduce the roadway and structural designers, and project leaders to the geologic/geotechnical issues that are expected to affect the project. Continued good communication between the geotechnical designer and the project leader and project team is vital.

### 3.1.1 Geotechnical Project Elements

All proposed project scopes should be reviewed by an engineering geologist and/or geotechnical engineer for a determination of the project elements (if any) that require a geologic investigation and geotechnical design. This allows the geotechnical designers to begin formulating a prospective scope of work and budget estimate. There are common project elements that are always the subject of a geotechnical investigation and design such as bridge foundations and landslide mitigations. Additionally, there are project elements that, depending on the site history and underlying geology, may or may not need investigation and design, or may require different levels of effort. The geotechnical designers will be able to determine the level of effort based on their own or other's knowledge and experience of the site to make these judgments. Because of the underlying site conditions, elements that generally do not warrant geotechnical design for most sites may require it at others. Conversely, investigation and design efforts may be scaled back or eliminated at other sites due to known favorable conditions, and the significance of the project feature. It is the responsibility of the geotechnical designers to make these decisions.

The common project elements on transportation projects that are the subject of engineering geologic investigation and geotechnical design for construction are:

- Structure Foundations (bridges, viaducts, pumping stations, sound walls, buildings, etc.)

- Retaining walls over 4 feet in height as measured from the base of the wall footing to the top of the wall and any wall with a foreslope or backslope
- Cuts, fills, and embankments
- Tunnels and underground structures.
- Poles, masts and towers.
- Culverts, pipes and conduits.

This last group of elements, culverts, pipes and conduits, exemplify the broad range of design and investigation that may occur on any project. A 24-inch culvert replacement at a depth of 3 feet below a proposed roadway alignment would normally require the hand-collection of soil samples from the pipe location, submittal of those samples to the laboratory for chemical properties testing, and forwarding the results to the project designer for selection of the appropriate pipe materials for that location. If however, that same culvert was to be installed under a large, existing embankment while under traffic using trenchless methods, then the required investigation and design effort would be close to what is required for a tunnel or underground structure.

### **3.1.2 Geotechnical Project Tasks and Workflow**

The expected milestones or Phase Gates for geotechnical input on projects and the review of geotechnical work is outlined in the Project Flowcharts in [Chapter 2](#).

Certain project checkpoints and tasks may be added or eliminated based on the project scope and/or requirements. Each individual project prospectus should be consulted to determine which tasks and QC checkpoints would apply.

## **3.2 Preliminary Project Planning**

### **3.2.1 General**

The creation of an efficient geologic/geotechnical investigation and identification of fatal flaws or critical issues that could affect design and construction as early in project development as possible is essential. Use the maximum amount of effort to obtain the greatest amount of information as early in each phase of investigation as possible so that each successive phase can capitalize on the information previously gathered. The result is a more thorough and cost-effective geologic and geotechnical investigation program.

Projects with a small number of defined structure locations or limited earthwork typically do not require numerous phases of investigation. Such projects normally proceed through an initial background study, site reconnaissance, and ensuing subsurface exploration at the TS&L phase. Larger projects in contrast, will usually benefit from a phased sequence of field exploration. The geologic/geotechnical investigation will occur as a reconnaissance-level examination and preliminary subsurface exploration during the Field Survey phase of the project. More detailed, site-specific exploration is accomplished later as the project develops through the TS&L and Approved Design phases.

Phased subsurface exploration is beneficial because:

- Issues or conditions that affect Scope, Schedule and Budget are identified early and adjustments to the project can be made in response.
- Phased subsurface exploration allows information to be obtained in the early stage of the project that can be used to focus the exploration plan for the more detailed design stages. This is where previously gained information can be used to maximize the efficiency of the final exploration, and to assure that previously identified geotechnical problems and/or geologic hazards are thoroughly investigated and characterized.
- Additionally, the Exploration Plan can be more clearly defined and easier to manage. In this regard, the number of borings, their depths, and laboratory testing programs can be determined in advance of actual mobilization of equipment to a project area.

For most projects, mobilization costs for exploration equipment are high, so efforts should be made to reduce the number of subsurface investigation phases whenever practical. However, the site location, project objectives and other factors will necessarily influence the investigation phases and mobilizations. Some of the additional factors to consider are site access, availability of specialized equipment, environmental restrictions, safety issues and traffic control.

To economize field investigations and provide contingencies for ongoing project changes, consider the following:

- A substantial amount of background study should take place prior to mobilization to a project site. The information derived from this research provides a basis for the design of the Exploration Plan and help focus the on-site investigation.
- In addition, all resources used in the development of the background study should be organized and documented in such a manner that another geotechnical designer would be able to continue the project without going back to the beginning to get the same information. Keep a list of all documents used in the background study, such as field notes and sketches from initial site reconnaissance, reports or investigations from previous or nearby site investigations, and other published literature.
- Any critical issues such as geologic hazards, problem materials or conditions, or contamination identified during the initial study should be clearly documented and highlighted throughout the project to avoid any surprises later on in the design or construction phases.

### **3.2.1.1 Project Scale and Assignment of Resources**

Geotechnical designers should use their professional judgment with respect to the scope, scale, and amount of resources to utilize during preliminary project studies. Larger projects obviously necessitate a greater effort in the early examination of background materials such as previous reports for an area, maps, published literature, aerial photographs and other remote sensing.

Even with the smallest bridge replacement or grading project, background study is just as important, and although of a smaller scale, should be carried out with the same diligence as a similar study for a major realignment. A thorough and expedient background study is essential for these smaller projects since unforeseen conditions and additional unplanned field investigations are much more difficult to absorb in a smaller project budget. It follows that for a larger project; a more thorough background investigation is warranted since unforeseen

conditions can have a compounding effect during design and construction that may affect even the most generously funded projects.

The amount of background research needed for a project is usually unknown until the study begins and the potential site conditions are assessed to some degree. It is up to the geotechnical designer to determine the amount of background study needed and the cost-benefit of such studies with respect to the project design.

### **Using Remote Sensing and Existing Information**

Ordering new remote sensing studies to assess surrounding landforms is probably not necessary for in-kind bridge replacement projects unless some special conditions are observed during the field or office study. However, failure to procure and study a set of aerial photographs along a proposed realignment would be poor practice. Project background studies for major realignment projects and landslide mitigations typically make more use of remote sensing and published literature while replacement and modernization projects will rely more heavily on previous site studies and reports. **All available information should be reviewed regardless of the project type.**

## **3.2.2 Office Research**

The foremost objectives of initial office study are 1) early identification of critical issues that will affect the project's scope, schedule or budget, and 2) efficiently plan detailed site studies and formulate a subsurface investigation program.

### **3.2.2.1 Office Research Step 1**

The first **step** of any project should begin with a review of the published and available unpublished literature to gain a thorough understanding of the existing site conditions and composition. Such an understanding includes knowledge of the geologic processes that have been the genesis of, or have in some way affected the project site. The site geomorphology should receive the most scrutiny from the geotechnical designer since characteristic landforms are created by specific geologic processes, and composed of particular materials. The site geomorphology, coupled with the literature and results of previous studies, will aid the geotechnical designer in predicting what materials will be encountered, and how they will be distributed across the site.

### **3.2.2.2 Office Research Step 2**

The second **step** of a project involves the detailed examination of the proposed project components and in particular, the geotechnical elements. This includes an appraisal of the project prospectus as well as any conceptual or preliminary plans available from the roadway designer or project leader. The project geotechnical features such as bridge foundations, earth-retaining structures, cuts, embankments and any other earthworks should be identified and located. Once the project geotechnical features are recognized, they can then be analyzed with respect to the background information previously collected.

### 3.2.2.2.1 Existing Information and Previous Site Investigation Data

Current transportation projects take place almost exclusively on or near existing routes, for which a considerable amount of subsurface information already exists, in most cases. Subsurface information is collected for bridge foundations, retaining walls, cut slopes, embankments, and landslides. Additional subsurface data has also been collected for incidental structures such as sound walls, sign bridges, poles, masts, towers and facilities such as water tanks and maintenance buildings. Since many transportation projects take place in urban areas, additional information may also be available from other nearby public works projects and private developments involving structures and earthworks. Local agencies may possess subsurface information for their projects as well as data provided by consultants.

Subsurface information collected for ODOT projects primarily resides in the region geology office in which the data was collected. The first inquiry into project geotechnical information should be to the appropriate region Geotechnical office. In addition to the region Geotechnical offices, additional information may be found in the following sources, which are all located in Salem:

#### Old Roadway and Geo-Hydro Section Files

Statewide geotechnical project files are also archived and stored in the main Oregon State Archives building in Salem. These consist of project files that were developed between about 1930 (or earlier) and about 2004. The bulk of the files are from the Geotechnical Group **when it was part of the Roadway Section** and typically involved roadwork projects such as landslide and rockfall repairs, embankment design and other roadway geotechnical work performed statewide during this time period. In 1997, the ODOT Bridge Section's Foundation Unit was combined with the Roadway Geotechnical Group and the ODOT Hydraulics Section to form a new Geo-Hydro Section. The Geo-Hydro Section later added the region geotechnical offices to the section and for a brief period of time up until 2004, geotechnical design was centralized in Salem and geotechnical project files for that period of time are stored in these archives.

The procedure for obtaining these hardcopy files are outlined in [Appendix 3-B](#). A database listing of the projects archived can be searched to see if a project of interest is available.

#### Bridge Section Archives

Past Bridge Foundation Reports, drill logs and other foundation design information, for projects designed prior to about 1997 are also stored separately in the State Archives Record Center in Salem. These files are located through use of the Bridge Section Archive database. Requests should be made through the HQ Bridge Section Office. In requesting these files, it is important to know the information needed to best locate the request material. [Appendix 3-C](#) summarizes the project information that should be included in the request in order to conduct for best search of the archive database.

#### HQ Microfiche Files

Construction records of past bridge projects are available on archival microfiche records in the Salem TLC office. These records extend back to at least the 1930's and may include information on pile installation (records), plan changes, survey field notes, material testing information and various written correspondence that took place during the construction of the bridge. The files are located in the *Maps and Plans* storage room of the Salem TLC and indexed by Structure Number. A microfiche viewer is available for viewing and saving selected files.

### **3.2.2.2.2 Office Research for Bridge Foundations**

In addition to the sources of information listed above, office research for bridge foundation work generally consists of a review of foundations for the existing structure and any other pertinent foundation information on other nearby structures. The structure owner may have subsurface information such as soil boring logs or "as-constructed" foundation information such as spread footing elevations, pile tip elevations, or pile driving records.

The HQ Bridge Section archives contain Foundation Reports and boring logs for many bridges constructed between the early -1960s to about 1997. Subsurface information on some earlier ODOT bridges may also be available in the Bridge Section construction records.

Maintenance and construction records for existing bridge(s) should also be reviewed for information relevant to the design and construction of the proposed structure. As-Constructed bridge drawings are available online, internally to ODOT through the ODOT Bridge Data System (BDS). Piles driving record books are also available on request from the HQ Bridge Section.

Office research work for structure foundations typically includes (but is not limited to) gathering the following information for the existing structure(s):

- Location and structure dimensions, number of spans, year constructed.
- Superstructure type (e.g. RCDG, composite, steel beam).
- Subsurface data (e.g. foundation reports, boring logs, data sheets, groundwater conditions, etc.).
- Type of Foundation (e.g. spread footings, piles, shafts).

Applicable "as-constructed" foundation information such as:

- Spread footing elevation, dimensions, and design or applied load.
- Pile type and size, pile tip elevations or lengths (pile record books), design or actual driven pile capacity and the method used to determine capacity (resistance) (dynamic formula (ENR, Gates), wave equation, PDA/CAPWAP).
- Drilled shaft diameter, tip elevations.
- Construction problems (e.g., groundwater problems, boulders or other obstructions, caving, difficult shoring/cofferdam construction).
- Foundation-related maintenance problems (e.g., approach fill or bridge settlement, scour problems, rip rap placement, corrosion, slope stability or drainage problems).

A review of old roadway design plans, air photos, and soil and geology maps and well logs may also be useful. Particular attention should be given to locating any existing or abandoned foundations or underground utilities in the proposed structure location. Any obstructions or

other existing conditions that may influence the bridge design, bent layout or construction should be communicated directly to the structural designer as soon as possible so these conditions can be taken into account in the design of the structure.

This information should be summarized and provided in the Geotechnical Report. All applicable “as-constructed” drawings or boring logs for the existing structure should be included in the Geotechnical Report Appendices.

The [Oregon Water Resources Department](#) maintains a database of boring logs on its website. By law, reports must be filed with this agency for all geotechnical holes and water, thermal, and monitoring wells. Thus, the database is fully populated, and may be queried in many ways geographically or by owner, number, constructor, or purpose. These logs are beneficial in rural or remote areas with a dearth of subsurface information.

**Note:**

*A wealth of information can be contained on the logs especially regarding groundwater and depth to bedrock information. There is an entry for soil and rock descriptions on the reporting forms. However, this information should be used with caution since there are no standard reporting formats and well drillers have historically used descriptors unique to their industry (for instance all blue tinted soils being logged as clays). As such, the soil and rock descriptions on the Water Resources forms vary in content and accuracy.*

The ORWD database can be located at [Oregon Department of Water Resources Database](#).

In addition to the information provided on the OWRD forms, it is important to simply note the presence of wells in the area that may be affected by the project construction. Projects involving large cut slopes or dewatering efforts can affect the yield of nearby wells. Where this occurs, ODOT typically includes replacement or deepening of the well as part of the Right of Way acquisition.

### 3.2.2.2.3 Construction Records

Since most current ODOT projects are modernization, replacement, or rehabilitations of existing transportation facilities, construction records are commonly available from various sources throughout the agency. Such records may be in the form of as-built plans, construction reports, pile-driving records and other technical memoranda addressing specific issues and recommendations during project construction. Locate information using:

- **As-built plans:** As-built plans are normally located in the region office where the project was constructed. The Geometrics Unit maintains the engineering documents in Room 29 of the Transportation Building in Salem where Mylar’s of project plans reside in addition to some of the as-built plans.
- **Pile records:** Pile record books are maintained by the headquarters office of the Bridge Section.

Region project engineers and construction project managers that have completed previous projects in the area should be consulted with respect to the geologic/geotechnical conditions as well as the construction issues related to those conditions. In addition, section maintenance personnel with a long history in an area will possess a wealth of information regarding the



performance of existing facilities; problems encountered, and repair activities that have taken place at a particular site.

### **3.2.2.2.4 Site History**

Past use of a site can greatly affect the design and construction of a project and can also make a significant impact to its timeline and budget. Typically, much of a site's background and past use will be researched and described for a Phase I or II Environmental Site Assessment produced by the **HazMat Geologists and Coordinators** or their consultants in the region geology offices. Information concerning the development of Environmental Site Assessments and other site use resources can be found in the HazMat **Program** Manual. Environmental Impact Statements (EIS) for previous projects in the area are also an important and concise source of previous and current site use information. Some of the remote sensing methods previously discussed may also help determine previous site use in the absence of historic records.

#### **Hazardous Materials**

The presence of hazardous materials in the subsurface not only affects the geotechnical design, and the construction approach to a project, but it also greatly affects how the subsurface investigation program is carried out. For this reason, it becomes important for the geotechnical designer to determine if previous use of the site, or surrounding locations could have potentially resulted in subsurface contamination. Such uses include any facility or enterprise engaged in the production, distribution, storage, or use of hazardous substances. Hazardous substances are defined by the [Environmental Protection Agency \(EPA\)](#) in 40CFR§261.31 through 261.33. In addition, the EPA further includes as hazardous wastes, such substances with characteristics of Ignitability, Corrosively, Reactivity, and Toxicity according to 40CFR§261.21 through 261.24. For transportation projects, the most commonly contaminated sites are those that are presently, or have previously been occupied by service stations. However, larger manufacturing and processing sites with substantial amounts of contamination are encountered. Within highly urbanized corridors, soil contamination is widespread (particularly within man-made fills) and all soils should be viewed as having the potential to be impacted. When geotechnical investigation must be conducted under such conditions, significant preplanning is required not only to protect the field crew, but also to comply with the numerous environmental regulations that govern everything from required PPE to disposal of contaminated drill cuttings.

#### **Naturally Occurring Hazardous Materials (NOHMS)**

Several naturally occurring minerals that pose a human health hazard are found at some locations in Oregon. These include Chrysotile Asbestos, the zeolite mineral Erionite, and heavy metal sulfides such as Cinnabar. Project geologists should be familiar with the formations and lithologies where these minerals occur. The potential for NOHM's should be conveyed to project teams as early as Project Scoping. Special provisions may be necessary for mitigation, employee safety, and management or disposal of the material.

Geologists must examine exposed, potentially NOHM-bearing rocks for the presence of suspect minerals that are identifiable. When identified, samples should be taken and tested at the

appropriate laboratory for verification. When NOHM's are suspected but not identified or minerals not identifiable in hand specimen may be present, discrete sampling and aggregated (i.e., composite) sampling methods should be employed. Samples must be sent to the appropriate laboratory for positive identification.

If NOHM's are positively identified, or where they are highly suspected, consultation with Region HazMat Geologists or Coordinators, the ODOT Safety Division, and Construction Section will be required to address how the project will proceed.

### **Previous Site Use**

In addition to contaminated materials, previous site uses have the possibility of leaving behind materials and/or conditions that can be detrimental to the construction or performance of a facility if not properly mitigated. In this regard, deleterious fill materials such as wood waste and ash are commonly associated with timber processing and other operations throughout the state while reclaimed quarries may be filled with deep, unconsolidated debris and spoils. Underground mines and tunnels are present in various locations throughout Oregon. Although uncommon, some instances of such features unexpectedly encountered during construction have occurred. In addition to their obvious geotechnical impacts, such features may be historic locations and thus, be protected by Federal law.

Analysis of previous site use can also help distinguish the various fill units encountered or other grading which will aid in later interpretation of geologic units from the "Anthropocene". Site use studies should also focus on changes to topography over time due to development or reclamation. Filled stream channels, swamps, springs, lakes, or other low-lying areas should be noted as they will also have a significant effect on a project. Records from the Oregon Historical Society: <https://www.ohs.org/> and Sanborn Maps: <https://www.loc.gov/collections/sanborn-maps> are one of the best sources of information concerning previous site use.

### **Previous Site Occupation Requiring Archaeological and Historic Protection**

In addition to previous site use, the geotechnical designer must also consider previous site occupation. A site previously occupied by Native Americans can contain artifacts, or be of significance to contemporaries. Such occupation may require archaeological investigation or preservation activities by qualified personnel. It is also possible that the exploration plan, or even significant project design changes prior to on-site geotechnical investigation will be required. Historic sites, structures, and even trees will also be protected in some instances that will necessitate adjustments to the proposed investigation. Clearly, much of the archaeological and historical issues in connection with a site are outside the purview of engineering geology and geotechnical engineering. However, the geotechnical designer must be aware of the issues to assure that field investigation activities are compliant with the laws and regulations that protect these resources. The Region Environmental Coordinator (REC) should be consulted on the Exploration Plan to evaluate the potential for archaeological/cultural resource impacts.

### **3.2.2.2.5 Site Geology**

The underlying geology of a project site provides important information concerning the conditions that may be encountered during the investigation and construction phases of a project. Of equal importance is the indication of conditions that either may not be encountered, or will require specific procedures to determine if they do exist. Some particularly deep bedrock horizons, groundwater surfaces, and boulders or other obstructions are examples. Certain conditions can be expected due to the nature of the project site geology.

Oregon has specific geologic terrains, formations and units with distinct constituents, properties and characteristics that greatly affect the design and investigation of a transportation project. For example:

- Many of the volcanic rocks that compose the Coast range, Willamette Valley, and Cascades can exhibit deeply weathered soil horizons with isolated zones of less weathered materials, interbeds of weak tuff and other unconsolidated tephra.
- Many of the coastal and inland valleys contain deep, soft sedimentary deposits formed by a rising sea level at the end of the Pleistocene.
- The Klamath Terrane in the southwestern portion of the State is a complex mixture of materials that present difficult conditions for the exploration as well as construction.
- The Coast and Cascade Ranges contain numerous large, existing landslides that may not be obvious until disturbed
- The Klamath Basin as well as the Basin and Range Terrane in South-Central and Southeast Oregon may contain thick deposits of Diatomaceous soils with unique and challenging engineering properties

Numerous published and unpublished documents are available that provide enough information upon which to base a background study. Naturally, many portions of the State have more information than others depending on population densities and previous site uses. However, some basic information is available throughout the state that can be used for most projects. The geology of a site must be researched and understood before mobilization of drilling equipment. The results of the office study are a key component of the subsurface exploration plan. The following sections provide a discussion of the most common publications and how they contribute to a background project study.

Procedures and techniques for the interpretation of maps, aerial photographs and other remote sensing products can be found in a wide variety of texts and other publications. Several engineering geology textbooks provide a good background in geologic interpretation for engineering projects. However, landform recognition methods are also very well presented in numerous geography texts and other related books devoted entirely to remote sensing and/or GIS. Geologic interpretation with specific emphasis on landslides is treated in Chapter 8 of the 1996 *TRB Landslides* publication.

#### **Topographic Maps**

The [U.S. Geological Survey \(USGS\)](#) prepares and publishes 7.5-minute topographic maps at a scale of 1:24,000 for the entire State, and for most of the rest of the U.S. Topographic maps can be used to extract both physical and cultural information about the landscape and their

consultation should be the first step in any site investigation. Contour lines provide information about slopes as well as indications of the underlying geology and geomorphology. The drainage patterns that develop in the contour lines also suggest geologic and human factors that may have influenced site conditions. Transportation and development patterns portrayed on USGS topographic maps are an often overlooked source of information. Many roads are aligned to avoid existing geologic hazards or areas where construction difficulties are expected such as wetlands, steep slopes, or hard, resistant rock cuts. Quarry and mine site locations are also an important clue with respect to the location and distribution of bedrock materials.

15-minute topographic maps, also produced by the USGS at a scale of 1:62,500 are also commonly available, but since they have been discontinued in favor of the 7.5' topographic maps, are becoming increasingly rare. The advantage of the 15-minute maps is that they can be very old and may show how land-use has changed in an area since their original survey. Previously existing wetlands that have since been filled or drained, waste areas, quarries, abandoned mines and other problematic areas with respect to transportation projects may be identified. Topographic maps should always be used to identify the arcuate head scarps and hummocky terrain indicative of landslides, wetlands, and general site accessibility with respect to investigation as well as construction.

The USGS maintains an on-line library of current and historic topographic maps that can be overlaid upon one another to review changes that have occurred between map updates. Maps can also be downloaded as .jpg files or georeferenced .tiff files. The USGS site can be found at: <https://ngmdb.usgs.gov/topoview/>

### **Sources of Aerial Photos**

Aerial photography is the most common, reliable, easy to use, and usually the cheapest source of remote sensing available. Aerial photos are very useful in planning subsurface investigation programs from gaining general knowledge regarding the geology, the extent, and distribution of materials, the location of geologic hazards, potential for encountering contaminants and determining access for exploration equipment.

Aerial photographs are available through a variety of sources. The ODOT Geometrics Unit would be the first source for aerial photos as their archives date back to the early 1950s and primarily cover the areas around the State's highways and the Oregon coastline. The US Army Corps of Engineers has coverage back to 1929, mostly along bodies of water (coasts and rivers).

Instructions and forms for ordering aerial photographs from the ODOT Geometrics Unit will be found on the [Agency's website](#). Instructions and forms for ordering from the Corps of Engineers is found on their [website](#).

Additional sources of aerial photography are:

- The [US Geological Survey](#)
- [USGS EROS Data Center](#)
  - <https://earthexplorer.usgs.gov/>
- The [USDA Aerial Photo Archives](#)

- [Bureau of Land Management](#)
- [University of Oregon's Aerial Photography Library](#)
- [GeoTerra, Inc.](#)

Many County Surveyor and/or Assessors offices throughout the State are an additional source of aerial photography. There are also a number of internet resources for low-resolution images for site location or other less-detailed applications.

### **General Use of Aerial Photography**

Aerial photographs may be taken on either black and white or color film. Each of them have characteristics that make them superior to one another for different applications although color photographs are generally considered better since many objects are easier to identify when shown in their natural colors. Things to consider include:

- Color photos also allow for the application of color contrasts and tonal variations to interpretations. In some circumstances, black and white photographs allow the geologist or engineer to resolve changes in slope or elevation that may otherwise be lost in the subtle color changes when using natural color aerial photos.
- Another, less commonly available type of aerial photograph are those taken in false color or infrared (IR). Color IR photography responds to a different electromagnetic spectrum than natural photography. Differences in soil moisture, vegetation type and soil and rock exposure are more readily identified on color IR film.
- Ideally, both black and white as well as color photos of a site should be analyzed for a complete analysis of all features unless color IR photos are available in which case it is generally agreed that for engineering geologic interpretation, natural color and color IR transparencies provide the best information.

With a general understanding of the site geology, the lateral extent of certain geologic features and deposits can be estimated from aerial photography. With a stereo-pair of photographs, the vertical extent can also be estimated in some circumstances. The use of stereo-pairs significantly increases the ease and accuracy of geomorphic interpretation. Subtle landforms may be discerned that may otherwise be hidden from view either on-site or on a two-dimensional image.

### **Geomorphic Identification from Aerial Photography**

Landform identification regularly allows the general subsurface conditions to be determined within the boundaries of that particular feature and thus, an opening impression of the materials to be encountered. Recognized landforms result from particular geologic mechanisms that allow such determinations to be made. These landforms are formed by distinct processes such as fluvial, glacial or **aeolian** and so they are composed of particular materials and compositions. Drainage patterns that develop within or as a result of certain landforms and geologic structures can be used as a diagnostic feature when studying aerial photographs. One of the more important landforms to distinguish during a preliminary study of aerial photography is landslides. Landslides are readily identified by their characteristic arcuate headscarps, patterns of disturbed soil and vegetation, standing water on slopes with no

apparent source or discharge (sag ponds), abrupt changes in slope, disrupted or truncated drainage patterns and upslope terraces.

#### **Other Applications of Aerial Photography**

Vegetation is another important feature to evaluate on aerial photographs since it frequently reveals certain subsurface conditions. Vegetative cover is related to numerous factors including soil development on certain bedrock units, depth of the soil profile, drainage and natural moisture content, climate and slope angle. In addition to the geologic characteristics, the condition or absence of vegetation may be a sign of soil contamination. Zones of dead or discolored vegetation can indicate the presence of a spill or chemical dumpsite that field exploration crews may not be prepared to encounter.

It is also important to review a sequence of aerial photographs from different years to determine the history of site use and the natural or human-caused changes that have occurred. Significant changes in the ground contours and shapes can indicate changes due to geologic processes such as landslides, erosion and subsidence or changes due to construction on the site such as filling and excavation. Other aspects of the site's history that can be determined are the activities that occurred on site such as chemical processing, fuel storage, waste treatment or similar activities, which may leave contaminated or other deleterious materials behind.

#### **Geologic Maps**

The [Oregon Department of Geology and Mineral Industries \(DOGAMI\)](#), USGS, [US Department of Energy](#), and other agencies publish geologic maps of most of the state at various scales. The USGS has published a map of the entire state at a 1:500,000 scale. These geologic maps generally use the USGS topographic maps as a base layer. Geologic maps portray the distribution of geologic units and provide a general description of each that includes the rock or sediment type, geologic age, origin, and brief summary of its properties and physical characteristics. Additional information concerning geologic hazards, groundwater, and economic geology is typically included.

DOGAMI also publishes special studies on geologic hazards in certain heavily populated or problematic areas of Oregon. Geologic Hazard maps are generally produced to portray specific themes such as slope stability, liquefaction potential, amplification of peak rock accelerations and potential tsunami inundation zones. Such maps provide a general indication of the extent and magnitude of the hazards they were produced to portray.

Geologic maps for the state are available from DOGAMI and at most of the State Universities libraries. Publications are also available on line from [DOGAMI](#). In addition, many local agencies and municipalities have contracted for hazard mapping and planning. These publications may be available from the local agency offices. DOGAMI **has completed** a digital map compilation for the state. This compilation allows for the electronic querying of geologic information published in a selected area. The geologic information contains pertinent engineering characteristics in many areas.

#### **Soil Surveys**

The US Department of Agriculture, Natural Resources Conservation Service (formerly the Soil Conservation Service) has published soil surveys for all of the counties in Oregon. Although these reports are intended for agricultural use, they provide valuable information on the surficial soils in and around a project area. These bound volumes include maps and aerial photographs showing the lateral extent of soil units and a description of the overall physical geography including local relief, drainage, climate, vegetation, and description of each soil unit together with its genesis. Commonly, the soil units are overlain on a topographic and aerial photographic base. The reports contain engineering classifications of the surficial soil units, a discussion of their characteristics such as drainage and susceptibility to erosion, and suitability for use in some construction applications.

### **Remote Sensing and Satellite Imagery**

Remote sensing, by the largest definition, involves the collection of data about an area without actual contact. By this definition, the previously discussed methods of air photo and map interpretation would be classified as remote sensing. However, for this section, remote sensing is restricted to imagery obtained by systems other than cameras, or images that are enhanced to distinguish different characteristics of the earth's surface.

Remote sensing as discussed in this section generally utilizes sensors that detect particular electromagnetic energy spectra that is mostly generated from the sun and subsequently reflected or emitted from earth. In addition, active systems that transmit and detect energy from the same platform such as an airplane or satellite are also used to collect imagery. The primary purpose of this distinction is that aerial photographs allow examination of images in the electromagnetic spectrum visible to the human eye. Other imagery allows examination of features with reflectance or energy emission properties that are either outside the spectrum visible to humans or occur with other features with overlapping spectral reflectance that obscures them to the human eye. Examples of these other remote sensing systems are: Multispectral Scanning Imagery, Thermal IR Imagery, Microwave Imagery, and Light Detection and Ranging. Despite their advantages, these remote sensing systems are not always a substitute for stereo photographs and their higher detail, interpretive returns and overall economy. They are merely a tool to allow additional interpretation capability for engineering geologic studies.

### **Thermal IR Imagery**

These systems obtain images from the thermal wavelength range, generally from 8 $\mu$ m to 14 $\mu$ m, and contain the energy emitted from the earth that was previously stored as solar energy. The thermal properties such as conductivity, specific heat and density of various materials produce different responses to temperature changes. Such responses can be measured to allow differentiation of various surface materials. In a sense, thermal IR imagery can be described as a photograph of the earth's albedo.

Obviously, the longer wavelength of thermal IR images will result in a much lower resolution than a corresponding photographic image. For this reason, thermal data is used to enhance images of areas with certain surface conditions that are not generally detected by aerial photography. In this regard, areas composed of materials with similar or overlapping

reflectance properties may not show up on an aerial photograph, but their different thermal properties will make them stand out on a thermal IR image.

The primary uses of thermal IR imagery are for mapping changes in soil and rock compositions and anomalous groundwater flow characteristics on an aerial photograph base. Typical engineering geology applications of thermal IR imagery are:

- Fault delineation
- Locating seepage at soil and rock contacts
- Mapping variations in weathered rock profiles
- Mapping near-surface drainage
- Multispectral Scanning Imagery (MSS)

MSS systems produce imagery from several distinct ranges, throughout the photographic and thermal spectrum. These distinct spectra are typically referred to as a band. Each spectral is concurrently recorded by the scanning instruments along the aircraft or satellite flight line. Much of the data available came from the Landsat satellite program during the 1970s and 1980s. The early Landsat satellites used only four spectral bands and achieved a resolution of about 80 meters. Later satellites used 7-band sensor array with a 30-meter resolution from 6 of those bands. The seventh was a thermal IR sensor. Special aircraft flights with 24-band sensors can also be obtained.

Images from MSS data can be used to examine the spectral signatures and reflectance of surficial materials and objects. Different soil and rock materials, as well as the extent of rock weathering, can be identified by comparing color variations from the different spectral bands. MSS image analysis for engineering geology is typically used to identify major landforms and tectonic features. In addition, the length of time over which the images were collected allows observation of changes in vegetation, land use, and the locations of catastrophic events such as fault rupture, flooding and landslides. As with thermal IR imaging, MSS is generally used as an enhancement of aerial photography rather than a substitute for it.

### **Microwave Imagery (Radar)**

Radar utilizes electromagnetic energy from the microwave spectrum, typically with wavelengths from 1mm to 1m. Radar imaging may come from either an active or a passive system. In this regard, passive systems are a form of thermal IR imaging using the wavelengths that increase to the range of microwaves whereas active systems emit pulses of energy that are transmitted to the earth's surface where they are reflected back to a receiver.

The most common technique for this type of imagery is Side-Looking-Airborne-Radar (SLAR). For this technique, the radar scans a portion of the earth's surface laterally from an aircraft in a direction perpendicular to the flight line and at a depression angle measured downward from the horizontal. Overlapping images created from this method allow stereo viewing of surface features and objects. Objects that are more perpendicular to the pulse provide a strong energy return to the receiver while smooth or horizontal surfaces reflect the energy away from the receiver resulting in a dark image. It then follows that reflection angles and surface roughness



as well as vegetation and moisture content influence the energy returned to the receiver. Objects and features extending above the surface project radar shadows that are related to the angle of incidence of the energy transmitted and received. These shadows accentuate the surface topography and thus, structural trends.

SLAR images are typically used in an engineering geology application to identify the surficial expression of geologic structures, drainage features, structural patterns and trends. SLAR imagery is complimentary to aerial photography and should not be a substitute for it. However, SLAR images have many advantages that provide additional information that is difficult to extract from an aerial photograph. Their primary advantage is the enhancement of major features that are obscured by the greater detail of an aerial photograph. Another advantage of SLAR is the ability to obtain clear images at night and in heavy cloud cover.

### **Light Detection and Ranging (lidar)**

This technology utilizes an active system that is similar to radar in the manner by which it creates an image. In this regard, energy is emitted from a source and reflected from the earth's surface back to a receiver. However, in this case, a laser is used to measure the distance to specific points and generates a digital elevation model of the earth's surface similar to standard photogrammetric methods. LiDAR equipment is typically mounted in an aircraft although numerous ground-based applications have been developed that are beneficial to highway engineering geology, and in particular, rock slope design.

The primary advantage of LiDAR is during post-processing of the data that allows vegetation to be stripped from the data to provide a bare-earth terrain model. This is a particularly useful technology in much of Oregon where heavy vegetation obscures much of the ground surface. Landforms that would typically be obscured stand out in sharp resolution on a LiDAR image where the vegetation has been removed. In addition to vegetation, structures and dwellings can also be removed. This is also advantageous where development has occurred over **existing** large, geomorphic **landforms** to the extent where they completely obscure its features. Disturbed areas and earthworks are also plainly visible on bare-earth LiDAR images. This allows clear distinctions to be drawn between fills and embankments, and natural ground surfaces. Bare-earth models also provide a clear resolution of existing stream courses and channels. Other imagery and photogrammetry-derived mapping often contain erroneously located stream segments due to forest cover and/or ongoing lateral migration. LiDAR images not only provide an unmistakable location of the stream course, but also a clear rendition of the stream banks and terraces.

ODOT currently stores LiDAR bare-earth and reflective imagery files on the GIS server as hill shade images and Digital Elevation Models (DEM) files. This server is accessible on the ODOT system. DOGAMI provides access to LiDAR imagery in a web-view format on their web page: <https://gis.dogami.oregon.gov/lidarviewer/>

Raw ASCII and .LAS-format files are available from ODOT's GIS unit as requested. In order to load the raw or binary datasets, an external hard drive of at least 500 GB capacity must be provided as these files are extremely large. LiDAR imagery and DEMs are normally viewed, manipulated and analyzed with GIS software and specific GIS software extensions. Specialized

software is also available for LiDAR data and imagery analysis. ASCII and .LAS files can be used to produce a .dtm file compatible with later versions of Bentley InRoads.

Numerous contractors are available that can provide LiDAR data products; however, ODOT usually participates in the Oregon LiDAR Consortium (OLC) for new acquisitions. The Oregon Department of Geology and Mineral Industries (DOGAMI) were given a legislative mandate to extend LiDAR coverage throughout the state. The consortium model was approved for funding, collection and sharing new LiDAR datasets. DOGAMI, as head of the consortium retains the LiDAR contractor and develops cooperative agreements between consortium members. The consortium benefits all members by provided additional coverage for lower cost. As the aerial extent of each acquisition order increases, the cost per square mile decreases. In addition to lowering the unit cost, more contiguous areas of LiDAR data are acquired providing greater benefit to all members. Members of the OLC include Federal, State, and Local agencies, Tribal governments, private entities, and not-for-profit organizations.

## **3.2.3 Site Reconnaissance**

### **3.2.3.1 General**

The purpose of site reconnaissance in geotechnical project planning is to verify the results of the office study, and to begin formulation of a site-specific exploration program that will address the issues identified, and determine some of the logistics required to complete the next phase of investigation. At this stage, the geotechnical designer should know what to look for at the site, and, with preliminary or conceptual plans in hand, should observe the anticipated conditions with respect to the proposed project features. Surficial expression of features and landforms should be checked on the project plans as well as delineating additional features noted during the site reconnaissance. It is also important to assure that the project maps are accurate with respect to the actual site conditions, and that significant features were not overlooked or misrepresented on the preliminary or conceptual design phase maps. The scope of the site reconnaissance depends greatly on the site conditions, accessibility and project complexity. The value of the site reconnaissance is realized later on in the project through a more efficient and thorough site exploration and geotechnical design. Therefore; site reconnaissance should be complete and systematic to achieve the final objectives of the office investigation, and may involve a significant level of effort in the field depending on the project site itself.

### **3.2.3.2 Verification of Office Research and Site Observations**

The topography and geomorphology of a site should be reconciled in the field with what was anticipated in the office study and shown on any maps or aerial photographs. Review and assess the following:

- Outcroppings, road cuts, streambeds and any other subsurface exposures should be noted to verify the anticipated conditions based on the published geologic maps and literature. The presence of artificial fills should be noted and described with respect to its composition, lateral extent and estimated volume.

- Surface waters, springs, wetlands and other potentially sensitive areas that may affect the project work should also be noted. In addition, an effort should be made to identify the 2-year flood zone for future reference.
- Boulders, blocks and oversized materials in streambeds, or projecting from embankments should be noted as they may be indicative of obstructions in the subsurface. Such obstructions are one of the most common sources of changing site conditions claims on projects that involve pile driving, shaft/tieback/soil nail drilling, and excavations. Oversized materials observed on the surface may not be encountered during exploratory drilling and thus, the field reconnaissance may be the only record of their occurrence. In addition to boulders and blocks, existing abandoned structures such as foundations and utility vaults can also be an obstruction to foundation installation and excavation.
- Any landslide features observed in the office study should be examined in addition to any new features discovered during the site reconnaissance. All indicators of unstable slopes such as springs sag ponds, bent tree trunks, disturbed plant communities, abrupt vegetation changes and hummocky terrain should also be noted. Measurement and delineation of all features and indications of slope stability should be completed during the reconnaissance. Complete investigation of slope stability affecting a project area necessarily involves areas that may extend a substantial distance away from the proposed alignment.
- The performance of existing and nearby structures should be evaluated during the site reconnaissance. Evidence of settlement, deformation, tilting or lateral movement can indicate site conditions that possibly will affect the project design and further exacerbate the performance issues during construction.
- At bridge sites, the existing footings should be evaluated with respect to stream scour. Exposed pile caps or footings as well as riprap protection generally indicate that scour has been a concern at the site previously.

### **3.2.3.3 Preparation for Site Exploration**

Potential boring locations should be identified with respect to the preliminary or conceptual plans available at the time of the site reconnaissance. Once the locations are determined, an assessment can be made in connection with how they will be accessed by exploration equipment and personnel. Many projects can be investigated by routine methods with common equipment. However, for some projects, site access can cost almost as much if not more than the actual subsurface exploration itself. Physical site access, traffic control, environmental protection and many other issues can arise that increase the complexity, and subsequently, the cost of the exploration program. Every site is different, so each must be assessed individually to determine what methods, procedures, equipment and subcontractors will be needed. Some of the most common issues that need to be addressed are:

- **Traffic Control** – Flagging, lane restrictions and pilot cars are required when working in or near the travel lanes. In such instances, traffic will need to be controlled for the entire time the exploration crew is on site. In other areas, traffic control may be needed while loading or unloading equipment and supplies. In many areas, lane restrictions are only

allowed for nighttime operations. In every case, all efforts will be made to minimize the impact to the traveling public.

- **Equipment Required** – Determining whether the site can be accessed using a standard truck-mounted drill rig or whether a track-mounted drill will be needed. It may also be necessary to consider difficult-access equipment that must be transported by crane, helicopter, or hand-carried.
- **Physical Access** – Considering additional equipment to access a site and analyzing the cost-benefits of their use vs. other drilling equipment and investigative methods. For some sites, bulldozers and excavators may be needed to construct an access road for drilling equipment, barges may be needed for in-water work, and special low-clearance equipment may be needed for work in and around utilities. Where access roads are problematic due to environmentally sensitive areas that need to be avoided, overall impact, cost and reclamation requirements; alternative equipment or methods should be looked upon as a potential cost or problem-saving measure where the integrity of the exploration information is not compromised.

For in-stream work, project scheduling becomes a significant issue since restrictions will be imposed on the times of the year when such activities will be allowed. Furthermore, the logistics of carrying out in-water work bring additional requirements such as determining the draft of the barge needed for the depth of the water, how the barge will be anchored, where the barge will be launched from, how the crew will access the barge during a shift change, and determining the effects of tidal or current changes on the drilling operations. A marine surveyor should be engaged for particularly complex over-water operations, and on some waterways, their review of operations is required.

Where bridges are replaced at their present location, and conditions allow, drilling may be conducted through the existing bridge deck although efforts must be made to assure that only the deck and not the superstructure are penetrated.

- **Drilling Conditions** – Where high groundwater levels, deep water, loose or heaving sands and gravels and obstructions are anticipated, the appropriate drilling methods and materials should be specified.
- **Materials and Support** – Remote locations may require special considerations for supporting the field crew and the equipment. In this regard, additional logistics may be needed for delivering drilling supplies, fuel, lubricants, etc., and for the timely delivery of samples back to the laboratory and office. All-terrain vehicles may be needed to support the drill crews in such situations, or else preplanning needs to be carried out to schedule or arrange for extra site provision. Locations for drill water should be identified ahead of time, and where an ODOT facility is not available, permits will need to be obtained ahead of time for fire hydrants, private sources, or extraction from streams and lakes.

- **Right of Way** – The methods by which permits of entry for exploration on private property are obtained vary from region to region, and frequently, within a region. For all cases, the region Right of Way section in which the project is taking place should be consulted prior to exploration, and then notified in advance, when and which private properties will be accessed. The Right of Way section manager or their subordinate will recommend either a standard permit of entry form, or they will obtain the permit of entry internally.

In many instances, private property owners will refuse to grant entry. For these, the Right of Way section will be required to handle the negotiations for site access, and determine the terms and conditions.

- **Utility Conflicts** – During the site visit, the location and type of utilities should be noted. The names and contact information located on the utility risers, stakes and poles should be recorded. In all cases, the Utility Notification (“One-Call”) Center must be contacted at least two working days prior to commencement of site operations at 1-800-332-2344. The One-Call Center will recount the utility services that they will notify based on their records. The geotechnical designer or drilling supervisor will be responsible for notifying any other utilities operating in the area based on their observations of facilities during the site reconnaissance. Responsibility for maintaining the utility location markings during site operations belongs to the field exploration crew.

### **3.2.3.4 Reconnaissance Documentation**

During the field reconnaissance, photographs should be taken of all the predominant features previously discussed. Each photograph should be appropriately labeled with the object of the photo, the direction it was taken, where it was taken from, the date, and ideally, the latitude and longitude of the photograph’s origin obtained with GPS equipment. A map of the project area showing relevant features observed and the geology of the area should be compiled.

#### **Site Reconnaissance Memo/Preliminary Geology Report**

The results of the office research and field reconnaissance should be documented in a Site Reconnaissance Memo or Preliminary Geology Report. This document forms the basis of the Exploration Plan to be developed for the ensuing subsurface investigation. It can also be used as the basis for future project decisions affected by the geology. Particularly; the additions of project features such as minor structures or traffic control devices. The report should provide a list and a description of all the observations made, and the prominent features encountered during the office study and site reconnaissance. Each feature should be located with reference to the project stationing or reference grid. Features should also be located with GPS equipment for long term record keeping as stationing may change or not be available for future users.

The Site Reconnaissance Memo or Preliminary Geology Report should be scaled according to the size or complexity of the project. Even small projects should have the site conditions and brief description of the site geology so that the aforementioned late project additions can be addressed. The text and essential figures of this report, in most cases, would be used again in

the final Geology or Geotechnical Reports as the site geology and site conditions section of those documents. These documents should also be written with the intent to address design deviations concerning subsurface exploration. Well-documented background data collection and site geology will expedite that process.

### **3.3 References**

- American Association of State Highway and Transportation Officials, Inc., 1988, *Manual on Subsurface Investigations*.
- C.H. Dowding, Ed., *Site Characterization & Exploration*, ASCE Specialty Workshop Proceedings, Northwestern University, 1978.
- [U.S. Department of Transportation, Federal Highway Administration Evaluation of Soil and Rock Properties, Geotechnical Engineering Circular No. 5, FHWA-IF-02-034, April 2002.](#)
- [U.S. Department of the Interior, Bureau of Reclamation \(2001\), Engineering Geology Field Manual, 2<sup>nd</sup> Edition, Volume 1.](#)
- Turner, Keith A., and Schuster, Robert L., Eds., *LANDSLIDES Investigation and Mitigation, Transportation Research Board Special Report 247*, 1996, Pages 140-163.
- Geotechnical Investigations, U.S. Army Corps of Engineers Engineering and Design Manual, EM 1110-1-1804, January 2001.

# Appendix 3-A Geology / Geotechnical QC MATRIX

**Table 3-1 Geology / Geotechnical Matrix Checklist QC Check #1 – Scoping**

	Geology			Geotech			Rock Slopes		
	YES	NO	N/A	YES	NO	N/A	YES	NO	N/A
Scope									
Project Name and Key Number									
Existing structures, earthworks and known hazards									
Proposed structures and earthworks									
Design Narrative, defined project area									
Project Geography									
Bodies of water									
Terrain Features									
Climate									
Region									
Project Geology									
Province									
Bedrock and Quaternary Geology									
Structural Geology									
Geologic Hazards									
Geomorphology									
Geologic Impacts/Performance of existing structures									
Performance of existing structures									
Previous design efforts in the project area									
Cost Estimates for Proposed Work (Design and Construction)									
Monitoring period									
Summary of findings and project implications									

**Table 3-2 Geology / Geotechnical Matrix Checklist QC Check #2 – Scope of Work**

	Geology			Geotech			Rock Slopes		
	YES	NO	N/A	YES	NO	N/A	YES	NO	N/A
Project Scope									
Schedule of work									
Geology Scope of Work									
Geotechnical Scope of Work									
Rock Slope Scope of Work									
Exploration Scope of Work									
Geology project budget									
Geotechnical project budget									
Rock slopes project budget									
Monitoring period schedule and budget									



**Table 3-3 Geology / Geotechnical Matrix Checklist QC Check # 3 – EIS**

	Geology			Geotech			Rock Slopes		
	YES	NO	N/A	YES	NO	N/A	YES	NO	N/A
Survey of proposed alignments and alternatives									
Bedrock units to be encountered									
Surficial units to be encountered									
Physical geography – effects on proposed alignments and/or slope geometries									
Location									
Extent									
Climate									
Topography									
Geologic Province									
Character of expected geologic units and their performance history									
Geologic hazard potential									
Summary of known geologic hazards									
Summary of known geologic impacts to existing features									
Performance of structures and earthworks along proposed corridors or alignments									
Known geotechnical-related problems in existing structures and earthworks in the proposed project area									
Mitigation methods and costs for potential geotechnical issues									
Geotechnical characterization/estimated properties of geologic units									
Discussion of the performance of project area materials and geologic units									
Correlation of properties of expected materials with similar studies									
Cost-benefit analysis of proposed alignments and/or locations									

**Table 3-4 Geology / Geotechnical Matrix Checklist QC Check # 4 – Concept**

	Geology			Geotech			Rock Slopes		
	YES	NO	N/A	YES	NO	N/A	YES	NO	N/A
Concept Plan Review									
Reconnaissance Report (File Summary Survey)									
Consultation of published literature									
Consultation of unpublished literature									
Aerial photographs and other remote sensing									
Aerial photographs from different years to review varying conditions through time and site history									
As-built plans									
Maintenance records									
Region file survey									
Consultant reports									
RHRS/Unstable slope inventory									
Review of maintenance activities that have affected the site (e.g. rock fall containment, slope stability, drainage)									
Review of geographic and geologic conditions affecting slope stability with respect to conceptual evaluation of landslide/rock fall remediation schemes									
Determine the potential effect of outside stakeholders on the remediation options (USFS, Gorge Commission, Tribal Governments, etc.)									

**Table 3-5 Geology / Geotechnical Matrix Checklist QC Check #5 – Exploration Plan**

	Geology			Geotech			Rock Slopes		
	YES	NO	N/A	YES	NO	N/A	YES	NO	N/A
Exploration Plan									
Exploration Plan Summary									
Survey Requirements									
Work Products									
Scope, Schedule, Budget									
Project Features requiring subsurface investigation									
AASHTO compliance for project features									
Boring/Exploration spacing									
Boring/Exploration depth									
Sampling frequency									
FHWA recommended standard practices for rock slopes									
Evaluation/inclusion of alternative or supplementary exploration methods									
Consideration of alternative tests and/or techniques that would provide better quality and economy									
Appropriate rock slope mapping and drilling programs for the proposed mitigation measure									
Evaluation of the expected site conditions and compatibility with standard exploration procedures									
Minimum explorations for trenchless pipe installation and associated features									
Exploration Plan Review									
Structures and earthworks for exploration									
Proposed exploration at each structure location									

**Table 3-6 Geology / Geotechnical Matrix Checklist QC Check #6 – 2/3 TS&L**

	Geology			Geotech			Rock Slopes		
	YES	NO	N/A	YES	NO	N/A	YES	NO	N/A
Field Exploration Review									
Site-specific field explorations									
Borings									
Test Pits									
Hand-auger holes									
Geophysics									
In-Situ testing									
Site and vicinity reconnaissance									
Project-level geologic mapping									
ASTM conformance									
Drilling methods									
Sampling and testing									
Deviations from standards noted and described									
Review of alternative tests or techniques									
Quantity of samples for laboratory testing (collection and recovery)									
Adequate samples and laboratory testing to characterize and determine the extent of subsurface materials									
Undisturbed samples in cohesive and/or compressible materials									
Core drilling procedures									
ODOT standard core box placement and labeling									
HQ or larger-sized core diameter									
Triple-tube recovery system									
Recovery appropriate for the materials encountered (never less than 80% unless special conditions exist)									
Core specimens labeled and photographed while wetted									
Legible and appropriate core photography									
Specimens removed for laboratory testing replaced in the core box with the appropriate marker									

	Geology			Geotech			Rock Slopes		
	YES	NO	N/A	YES	NO	N/A	YES	NO	N/A
Drilling techniques correspond to the materials encountered									
Augers used while investigating for the piezometric surface in soil									
Indication where natural moisture content was altered by introduced fluids									
Methods used to determine piezometric surface in rock									
Fluids used to stabilize boreholes in sandy material or other heaving conditions									
Measures to avoid affecting SPT and other testing values and intervals in heaving conditions									
Drilling activities recorded on standard boring log forms									
Fluid return and color changes									
Drill action and rate									
Shift/personnel changes									
Bit wear									
Drilling techniques									
All information used for interpretation of subsurface conditions									
Locations where groundwater was encountered									
Open hole water levels recorded at the beginning of each drilling shift									
Dry holes specifically noted									
Types, quantities, ad depths of backfill and sealing materials									
Soil and rock materials identified, classified, and described according to the current version of the ODOT Soil and Rock Classification Manual									
Complete soil and rock descriptions									
Additional physical properties, diagnostic, or distinguishing features recorded on the logs									
Boring locations surveyed with respect to State Plane Coordinates and true elevations									
Conversion to SPC/true elevation where assumed values are used									
Borings referenced by project stationing									

	Geology			Geotech			Rock Slopes		
	YES	NO	N/A	YES	NO	N/A	YES	NO	N/A
Borings referenced by bearing and distance to permanent features or reference points in the absence of an existing base map or survey									
Preliminary subsurface drawings and/or model for adjusting exploration according to current findings									
Boreholes abandoned according to Water Resources standards									
Instruments installed according to their purpose (e.g. inclinometers installed below the slide plane, piezometer-sensing zones in the water-bearing strata, etc.)									
Records of piezometer casing type/size, slotted zones, slot size/frequency									
Records of sealing and filter pack placement, sizes and grades of the materials									
VWP Installations									
Manufacturers calibration sheets									
Field calibration results									
Initial reading consistent with manual observation									
Inclinometers									
Appropriate slurry mixture									
Slurry quantity recorded									
Distinct zones of grout-take noted									
A0 direction noted, proper A0 inclinometer alignment									
Tube stick-up recorded									
Water Resources Hole Reports completed correctly and filed within the 30-day requirement									
Appropriate rock mass classification system used to evaluate rock slope excavation performance									
Rock slope surface mapping									
Overburden thickness and type									
Discontinuity thickness, type, surface roughness, spacing, orientation, and shape									
Zones of differential weathering on the slope									
Location and volume of seeps and springs									
Preliminary Geotechnical Recommendations									

	Geology			Geotech			Rock Slopes		
	YES	NO	N/A	YES	NO	N/A	YES	NO	N/A
TS&L Foundation Design Memo									
Description of proposed project									
Anticipated subsurface conditions									
Preliminary foundation design recommendations									
Foundation types									
Preliminary capacities									
Rational for selecting the recommended foundation type and capacity									
Discussion of liquefaction potential and associated effects									
Suggested retaining wall types									
Preliminary slope recommendations									
Site Model Review									
All exploration locations located on plan view maps referenced to the project									
Plan view maps developed to the appropriate scale to show the necessary features with respect to the overall project									
Appropriate plan map contour interval and labeling									
Borehole collar elevations consistent with nearest contours									
Standard map elements									
Cross-sections, fence diagrams, profiles and/or block diagrams used to display the 3-dimensional distribution of geologic units, features, structures, and engineering properties									
Geologic model consistent with engineering properties of defined units									
Material properties/laboratory testing results recorded on the drill logs									

	Geology			Geotech			Rock Slopes		
	YES	NO	N/A	YES	NO	N/A	YES	NO	N/A
Laboratory testing used to develop engineering geologic units									
Laboratory testing results displayed graphically to support the engineering geologic model (e.g. graphs or charts plotting engineering properties with depth or along a graphic lithology column)									
Laboratory testing program included samples from each boring or test pit to confirm the field and visual classification									
Laboratory results incorporated into the final drill logs and subsurface model									
Laboratory testing to verify or confirm interpretations or further characterize a unit									
Final drill logs match the interpretive drawings and preliminary drawings for the Geotechnical or Foundation Datasheets									
Clear distinction between observed and inferred features and relationships in the geologic model									
Review laboratory test results to determine if modifications are required in specific geologic units at different locations in the subsurface model									
Process developed to incorporate laboratory testing to assure correct and consistent material classification and description between borings and to develop engineering geologic stratigraphy from the test results									
Review physical properties testing to determine if initially misidentified materials occur elsewhere in the project subsurface									
Related soil classifications modified as a result of physical properties test results									
Results of instrumentation programs match the engineering geologic model									
Geologic model encompasses the project design details to show the effect of the geology on the facility									
Proposed cut lines, excavations, tunnel/pipe alignment, and foundations all plotted in the subsurface model									
Geologic features affecting the design such as seeps, springs, piezometric surfaces, and									



	Geology			Geotech			Rock Slopes		
	YES	NO	N/A	YES	NO	N/A	YES	NO	N/A
daylighted adverse structures clearly shown and identified in the model									
Blocky or rubble-zones that could produce over break in rock cuts or excavations									
Boulders or other obstructions in proposed excavations or pile and shaft foundations									
Groundwater surfaces									
Delineation of collapsible or expansive soils									
Cuts or fills on known or potential slide areas									
Foundations in or near bog/marsh areas									
Excavations below the groundwater surface, determination of the amount of water that will be encountered and the effect of piezometric drawdown on groundwater resources									
Delineation of potentially soft subgrade on the project plan map									
Geologic interpretation of materials and stratigraphy incorporates the engineering properties of the strata encountered (e.g. geologic units are subdivided down to the level of distinct engineering properties)									
Cross-cutting relationships established									
Quaternary-aged features and discontinuities identified									
Determine if weak or weathered rock sources identified for use on the project are likely to be friable or nondurable									
Slake Durability testing of exposed rock face material									
Thorough representation of materials tested for strength and compressibility rather than reliance on empirical correlations, especially those based upon Standard Penetration Tests									
Appropriate strength tests conducted to distinguish between drained and undrained conditions where needed									

Determine if the total stress envelope of the CIU test with pore pressure measurements has been used improperly to define the relationship of undrained shear strength with depth

Determine if the existing and proposed state of stress has been accounted for during strength testing

Evaluation of consolidation tests: reconciliation of the test-derived preconsolidation pressure with the actual stress history of the sample

Geology			Geotech			Rock Slopes		
YES	NO	N/A	YES	NO	N/A	YES	NO	N/A

**Table 3-7 Geology / Geotechnical Matrix Checklist QC Check #7 – Preliminary Plans**

	Geology			Geotech			Rock Slopes		
	YES	NO	N/A	YES	NO	N/A	YES	NO	N/A
Engineering Geology Report									
Geotechnical Report									
Rock Slope Report									
Preliminary Geotechnical Datasheets									
Datasheets completed for all required structures or features									
Profiles drawn along project alignment centerlines or specific offsets									
Cross-sections, additional profiles completed to show structure-specific information, or to provide additional information in areas of complex geology									
Sample and property data									
Subsurface model used to develop the Geotechnical Datasheets									
Subsurface information shown on the datasheets matches the final logs									
Drawings made at appropriate scales to show the needed level of detail									
Interpretation shown on the datasheets									
Geotechnical Datasheets completed according to Subsurface Information Policy									
Detail Drawings and Plans									
Review geotechnical items in the bid schedule									
Assure specification writer's review of geotechnical items in the special provisions									
Review specification writer's modifications of geotechnical items in the special provisions									
Correct length and locations for buttresses, surface and subsurface water collection and discharge features shown on the plans									
Correct materials called out on the plans									
Sequence of construction for buttresses									
Staged construction sequence for surcharging, wick drains, and ground improvement									
Appropriate drainage discharge locations									
Recontouring of slide areas clearly shown									
Surface water drainage in slide areas addressed in the plans or detail drawings									

	Geology			Geotech			Rock Slopes		
	YES	NO	N/A	YES	NO	N/A	YES	NO	N/A
Buttress, drainage, or other features shown with the correct elevations and dimensions									
Slope protection mat and rock fall protection fences									
Mesh type									
Anchor spacing									
Quantities									
Special provisions, including those for high-impact fences									
Standard Drawings included in the plans									
Special access issues and requirements									
Standard drawings and special provisions for PVC-coated mesh									
Rock Bolts and Dowels									
Design Loads									
Design Lengths									
Locations									
Quantities									
Corrosion protection									
Performance and proof-testing requirements									
Reference to the Qualified Products List									
Rock fall Retaining Structures									
Type, Size, and Location									
Quantities									
Slopes (Rock fall Protection Berms)									
Backfill type specifications									
Special Provisions									
Rock Slope Drainage									
Location									
Drain lengths									
Drain angles and orientations									
Quantities									
Water collection and disposal									
Shotcrete									
Locations									

	Geology			Geotech			Rock Slopes		
	YES	NO	N/A	YES	NO	N/A	YES	NO	N/A
Areas of coverage									
Quantities									
Anchorage									
Reinforcement									
Standard drawings and details									
Drainage									
Performance requirements									
Installation details									
Temporary Rock fall Protection									
Review type for suitability									
Locations									
Length									
Height									
Required materials and quantity									
Details									
Rock Blasting and Rock Excavation									
Quantity of Controlled Blast Holes									
Overburden slopes and slope breaks shown on the plans									
Special Provisions									
Blast Consultants									
Noise/vibration monitoring									
Preblast survey									
Blasting plan review									

**Table 3-8 Geology / Geotechnical Matrix Checklist QC Check #8 – Advanced Plans**

	Geology			Geotech			Rock Slopes		
	YES	NO	N/A	YES	NO	N/A	YES	NO	N/A
Preliminary Wall Drawings									
Review subsurface information on Geotechnical Datasheets for retaining structures									
Retaining Wall Drawing Review									
Type, Size, Location, Height, Backslope									
Quantities									
Backfill types									
Wall drainage									
Special Provisions									
Design Changes and Addenda									
Design calculations for added structures and features									
Design calculations for structures and features that have moved									
Review design assumptions									
Changed Criteria									
Changed Type, Size, Location									
Changed Quantities									
Additional exploration requirements for added structures or features									
Appropriate exploration carried out for added structures or features									
New data incorporated into the overall geologic interpretation									
Further characterization of geologic units with additional data									
Resolution or confirmation of previous inferences and interpretation									
Additional risk assessment									

**Table 3-9 Geology / Geotechnical Matrix Checklist QC Check #9 – Final Plans**

	Geology			Geotech			Rock Slopes		
	YES	NO	N/A	YES	NO	N/A	YES	NO	N/A
Final Plan Review									
Geotechnical or Foundation Datasheets completed for all structures, facilities, ad features for which they are required									
Geotechnical Datasheets completed according to Subsurface Information Policy									
Engineer or Geologist has stamped all sheets that they are responsible for									
Information provided on the datasheets exactly matches what is presented on the final logs and in the Engineering Geology report									
Final review of detail and plan sheets									
Final review of bid item quantities									
Final review of Special Provisions									

## **Appendix 3-B OLD ROADWAY AND GEO-HYDRO SECTION FILE RETRIEVAL**

These are project files that were developed between about 1930 and 2004. The bulk of the files are from the old Roadway Section Geotechnical Group and typically involve landslide and rockfall repairs, embankment design and other roadway geotechnical work performed statewide during this time period. Bridge and retaining wall foundation design work was done in the Bridge Section Foundation Unit up until about 1997 and those project files can be found in the ODOT Bridge Section archives. In 1997 the old Bridge Foundation Unit and the Geotechnical Group (which was under the Roadway Design Section) were combined (along with the bridge and roadway hydraulics units) to become a new ODOT Geo-Hydro Section. From 1997 to about 2000, Region Geology Sections were gradually incorporated into the Geo-Hydro Section until there was a statewide Geo-Hydro Section. Then in 2004, the ODOT reorganization plan decentralized G-H section personnel back to the individual regions and Salem headquarters.

Therefore, geotechnical project files in the state archive system consist of the following:

1930 – 1997: Project files from the original Roadway Geotechnical Group; these are statewide highway projects, typically roadway related only (no bridgework)

1997 – 2004: Project files for statewide roadway and bridge work (Bridge Foundation Unit and Roadway Geotechnical Groups were combined)

After 2004, all geo-project work was relocated to the regions and all new project files should be found in each regions filing system.



## Appendix 3-C Bridge Section File Archive Retrieval

The following information should be supplied to the HQ Bridge Section to find project files in the Bridge Archives:

- Contract Number
- Bridge Name
- Bridge Number
- Section Name

This is the information that is most likely typed on the archive project file labels and recorded in the Bridge Section archives database. The following narrative and instructions are intended for ODOT personnel with access to ODOT computer servers and databases. Outside agencies and consultants should contact the HQ Bridge Section for assistance in retrieving Bridge Section archive files.

Many projects have more than one bridge included in the project files and not all the bridge numbers are listed on the contract file labels and, if so, they are not recorded in the archive database. If you search the archive data based on the bridge number alone and do not find the file(s) this way, they may still be there. If the files are not found using just the bridge number, then find and search by the contract number of the project that constructed the bridge to see if the bridge files can be found that way. In addition, when there was more than one bridge in a project, the contract file label typically listed only the lowest bridge number of all the bridges in the project.

**Finding the Contract Number:** Searching by contract number is the best way to find the project file. Contract numbers are not in the BDS and one way to find them is using the FileNet database of scanned roadway plans (similar to the BDS). Once you are logged into FileNet, go to “Map Center” and then “Contract Plan Search.” Search the database using the bridge number, project title, highway/M.P., or other information to find the plans set that contains your bridge. Once you are sure you have the right project, click on the “Contract Plans Properties” link (little link in the third column, next to Project Title) and the project’s contract number is in there. Also, take note if any other bridges were built on the project with LOWER bridge numbers than the one you are looking for.

Search the bridge archives using the Contract Number, Section Name, and Bridge Number and also by the LOWEST bridge number in the project

# Chapter 4 - Field Investigation



## Chapter Contents

<b>Chapter 4 - Field Investigation .....</b>	<b>4-1</b>
4.1 Introduction .....	4-3
4.1.1 Established Investigation Criteria.....	4-3
4.1.2 Design Exceptions In Subsurface Investigations .....	4-4
4.2 General Subsurface Investigation.....	4-4
4.2.1 Subsurface Investigations – Phases .....	4-5
4.3 Exploration Plan Development.....	4-7
4.3.1 Exploration Plan Considerations .....	4-7
4.4 Exploration Management and Oversight .....	4-19
4.5 Subsurface Exploration Requirements.....	4-20
4.5.1 General.....	4-20
4.5.2 Exploration Spacing and Layout.....	4-21
4.5.3 Exploration Depths .....	4-31
4.5.4 Sampling Requirements .....	4-34
4.5.5 Sampling Methods .....	4-36
4.5.6 Sample Disposition .....	4-39
4.5.7 Exploration Survey Requirements.....	4-39
<b>4.5.8 Exploration Numbering .....</b>	<b>4-40</b>
4.6 Subsurface Exploration Methods.....	4-40
4.6.1 General.....	4-40
4.6.2 Test Boring Methods.....	4-40
4.6.3 Alternative Exploration Methods and Geophysical Surveys.....	4-50

4.7 Geotechnical Instrumentation ..... 4-50

    4.7.1 General – Instrumentation and Monitoring ..... 4-50

    4.7.2 Purposes of Geotechnical Instrumentation ..... 4-51

    4.7.3 Criteria for Selecting Instruments ..... 4-52

4.8 Environmental Protection during Exploration ..... 4-56

    4.8.1 Protection of Fish, Wildlife, and Vegetation ..... 4-57

    4.8.2 Forestry Protection ..... 4-57

    4.8.3 Wetland Protection ..... 4-57

    4.8.4 Cultural Resources Protection ..... 4-58

4.9 References ..... 4-59

Appendix 4-A Permit of Entry Form ..... 4-60

Appendix 4-B Utility Notification Worksheet ..... 4-61

**List of Tables**

---

Table 4-1 Specific field investigation requirements ..... 4-28

## 4.1 Introduction

This chapter covers Subsurface Investigations. The field and office studies described in [Chapter 3](#) inform decisions concerning subsurface investigations. These studies must be complete before commencing a subsurface exploration program.

For any transportation project that has components supported on or in the earth, there is a need for subsurface information and geotechnical data during its planning, design, and construction phases. Any geologic feature that affects the design and construction phase of a project, or has a bearing on site or corridor selection in terms of hazards and/or economics must be investigated and analyzed. Of equal importance is the clear and accurate portrayal of these conditions in a format that is accessible and understandable by all users.

Consider the following during field investigation:

**Subsurface investigation:** The objectives of a subsurface investigation are the provision of general information on the subsurface conditions of soil, rock, and water, and specific information concerning the soil and rock properties that are necessary for the project geotechnical design and construction.

**Scale of investigation:** For transportation projects in Oregon, the appropriate scale of investigation must be carefully considered. Because of Oregon's geology and geography, subsurface conditions are complex and may vary widely over short distances. A more thorough investigation will provide additional information that will generally decrease the probability of encountering unforeseen conditions during construction, and increase the quality and economy of the geotechnical design of a project.

**Balance of investigation:** Time and fiscal considerations will constrain the scale and resolution of the field investigation. Therefore, the geotechnical designer must balance the exploration costs with the information required and the acceptable risks.

The technical decisions and details required for site investigations require the input of trained and experienced professionals. Every site has its own particular circumstances and diverse geologic conditions. Professional experience, available equipment, and the previously described time and budgetary restraints all contribute to the **successful outcome of** site investigations. The implications of site-specific geologic conditions for the type of proposed facility must be investigated for each project. The remainder of this chapter describes established ODOT criteria to be used in field investigations as well as information on any areas where ODOT's criteria differs from the FHWA and AASHTO guidelines. More information can also be found in the Federal Highway Administration *Subsurface Investigations - Geotechnical Site Characterization Reference Manual (FHWA NHI-01-031)*.

### 4.1.1 Established Investigation Criteria

Professional experience and judgment are the basis of any field investigation program. This chapter is not intended to provide a prescriptive approach to field investigation, however; there are some established base levels of investigation for transportation facilities that must be

mandated to assure consistency and quality throughout the agency, and to address a common level of risk acceptance.

- These baselines were based on Federal guidance and the *AASHTO Manual on Subsurface Investigations*, 1988. ODOT has adopted the baseline requirements for subsurface investigations from the AASHTO Manual.
- However, due to the more variable conditions found in Oregon, ODOT's practice is slightly more rigorous with respect to exploration spacing and sampling. ODOT variance from AASHTO guidelines is outlined in Section 3.5 (Subsurface Exploration Requirements) and Section 3.6 (Subsurface Exploration Methods). *LRFD Bridge Design Specifications, Section 10* provides an additional resource for subsurface investigations, supplementary to the AASHTO guidelines.

The most important component of subsurface investigation is the personnel who carry out the field activities, interpret the information, and present the results in a clear manner to those responsible for the final geotechnical design and construction of the project. The quality of information produced from a subsurface investigation can vary substantially depending on the experience and competence of the personnel charged with its conduct. Radically different interpretations and conclusions can result from substandard investigation programs. Subsurface investigation is an investment in the success of a project with returns that are many times the cost of the investigation. The return on investment is realized during final design and construction, and later, during operation.

### 4.1.2 Design Exceptions In Subsurface Investigations

Every project site has its own specific geologic conditions as well as time, budgetary, and access constraints that must be considered when developing an exploration plan. When qualified Engineering Geologists and Geotechnical Engineers apply sound judgement to subsurface investigations, Design Deviations should not be necessary for most projects. The Design Deviation process, as applied to subsurface exploration, is intended to provide a course of action for Professionals of Record to balance project risk with cost-effective exploration programs. When the Project Engineering Geologist or Geotechnical Engineer determine that a significant change to the base levels of exploration is necessary, the Design Deviation process described in [Chapter 1 \(Section 1.3.2\)](#) should be followed.

## 4.2 General Subsurface Investigation

For most projects, the main purpose of a subsurface investigation program is to obtain the engineering properties of the soil and rock units and define their vertical and lateral extent with respect to thickness, position in the stratigraphic column – their depth, and aerial extent where they could affect the design and performance of a structural or earthwork feature.

The properties normally evaluated include Index Properties such as:

- natural moisture content
- Atterberg Limits

- Grain size
- Electrochemical properties (pH and Resistivity)

Additional physical properties may be evaluated, such as

- shear strength
- density
- compressibility
- permeability.

The location and nature of groundwater is evaluated in every subsurface investigation. In addition to material properties, subsurface investigations are carried out to explore and monitor geologic hazards that were identified in the office studies previously conducted.

For this later purpose, landslides are the most common hazard although caverns, compressible materials, high groundwater, faults, and obstructions may also form the basis or extension of a subsurface investigation program.

Subsurface investigation also serves an essential role in evaluating the constructability of a project. The underlying geology of a site provides essential information to contractors for evaluating means and methods, cost estimating, and bidding. Information about subsurface conditions that affect constructability are equally essential to both contractors as well as construction project managers. The role of the subsurface investigation in resolving construction disputes cannot be understated and should be considered throughout all project phases.

## **4.2.1 Subsurface Investigations – Phases**

Subsurface investigations may be carried out with varying levels of intensity depending on the phase of the project for which they are conducted. The typical phases are described in the following sections.

### **4.2.1.1 Advance investigations**

For preliminary or Alternative Design phases (Previously described as “Phase 1”) of a project, the information gathered from the office study is usually sufficient for preliminary geologic/geotechnical input to the project team and for completion of the Soils and Geology chapter of the Environmental Impact Statement (EIS). In the case of large landslides, large and/or complex project, or if geologic conditions will have a major impact on the design and construction of a project, an Advance Investigation would be warranted. In Advance Investigations, some amount of subsurface investigation would be collected to determine the general location and extent of the problems and to devise some preliminary cost estimates and alternatives. Ideally, when performing an Advance Investigation, the exploration would be situated at the location of a major project feature that would be investigated later during project design. However, as this occurs early in the project, or certain other alternatives are under consideration, the precise locations of bridge bents and final alignments may not be known. Advance Investigations are particularly valuable for preliminary evaluation of large landslides where a substantial period of instrumentation monitoring is needed.

### **4.2.1.2 DAP**

The Design Acceptance Phase (DAP) of project design is where the most intense and focused subsurface investigation occurs for specific project features. Wherever possible, the DAP investigation should capitalize on any previous explorations in the project area. Personnel responsible for the field investigation and geotechnical design should determine the utility of this information.

The DAP subsurface exploration and testing program provides the geotechnical data specifically required by the project's geotechnical design team. The investigation provides the aforementioned informational needs for the foundation and earthworks design as well as:

- Additional information applicable to other related project elements such as the chemical properties of soil with respect to corrosion of structural elements, and issues associated with environmental protection and erosion control.
- The project geotechnical design analyses, decisions, and recommendations for construction will be based on the information gathered during the DAP investigations.

For these reasons, the information gathered during this phase of investigation should achieve a degree of accuracy, thoroughness of coverage, and relevancy to support the project design decisions and to allow for realistically accurate estimates of geotechnical bid items. It is important to gather and analyze enough information at this point to minimize project risk with respect to changes in scope, schedule, and budget from geologic conditions and geotechnical design considerations. The DAP stage of project development is expected to capture the entire project footprint in all aspects including costs. The Phase Gate established for the end of DAP is intended to prevent substantial project changes after financing has been committed to a specific project design so it is important to have a thorough understanding of the project subsurface as early as possible.

### **4.2.1.3 Other Phases**

There will be some instances where additional subsurface investigation is necessary during Advanced Plans, Final Plans, or even during the construction phase of a project. This is not necessarily due to an incomplete investigation during the project design phase, but rather the result of unforeseeable problems that arise during construction, or late design changes following the main investigational effort and/or geotechnical design. Subsurface investigation is conducted to provide design information. Explorations conducted during construction are uncommon, and are usually carried out to resolve problems or answer questions that arise while the project is being built.

Occasionally, explorations will occur as part of the construction activity to install and monitor needed instrumentation. When design changes occur late in a project, additional subsurface investigation can be necessary to confirm the geotechnical design assumptions or to develop additional information.

## 4.3 Exploration Plan Development

The Exploration Plan is a document that describes the subsurface investigation activities that will take place to obtain the engineering properties required for geotechnical design. The objective of the Exploration Plan is to:

- Assure that the sampling and testing carried out for the subsurface investigation thoroughly covers each of the geologic units applicable to the geotechnical design.
- Verify that the maximum amount of information can be obtained from the fewest number of borings or other higher-cost methods.

In order to achieve this, the plan must be updated and modified as exploration proceeds to make sure that the number of samples taken, and tests performed in each unit provides enough numeric measurements of each critical engineering property. **The plan must also assure that information is collected throughout** the geologic unit to provide enough confidence to base the geotechnical design upon. In this regard, the properties of a material at one end of a long alignment may not hold true for the other end, and a geotechnical designer will not want to base all design parameters for that material on only one or a few samples.

Subsurface investigation conducted during the project design phase must fully define the subsurface conditions at a project site to meet the requirements of geotechnical design. The proper execution of the Exploration Plan will assure that samples and tests are numerically adequate and distributed vertically and laterally throughout each geologic unit, and that every important geologic unit at the site is discovered and investigated to the maximum feasible extent. The Exploration Plan will also assure that the site investigation is conducted in accordance with the standards of practice outlined in the 1988 AASHTO *Manual on Subsurface Investigations* and augmented in this manual. These standards are further subject to modification due to the variability of the site geology, sensitivity to potential changes, and risk or potential impact.

**Note:**

*Exploration Plans should be created, reviewed, and executed by an experienced engineering geologist or geotechnical engineer.*

The geotechnical designer should comprehensively evaluate the various methods and procedures for subsurface exploration that are currently available to maximize the amount of information gathered while reducing costs to the extent possible. The most common method for achieving this is to gain the most information from the fewest number of borings.

Alternatively, various types of exploration methods may be used where practical in lieu of the more expensive borings to realize those cost savings without compromising the necessary acquisition of information.

### 4.3.1 Exploration Plan Considerations

One of the leading issues addressed when developing the Exploration Plan is the overall scale or intensity and level of effort for the subsurface investigation. To answer these questions, the



expected complexity of the project site's geology must be considered with respect to the nature of the proposed project, and the project's requirements from the subsurface investigation.

In effect, there are some primary factors that will necessitate increasing the Exploration Plan for a larger-scale subsurface investigation including:

- complex site geology
- complex site conditions
- scale of the project
- sensitivity of the facility to variations in site conditions

The subsurface investigation program should be scoped according to these issues rather than from some baseline requirement. Each exploration should be justifiable in terms of the information needed from it. Such informational requirements form the basis of the following criteria:

- the type of boring
- location
- depth
- types of sampling
- sampling interval

These questions can only be answered by the experience, knowledge, and application of engineering geologic principles by the geotechnical designer. Through careful examination of the results previously obtained by the office study, and previous experience working in the area are the essential elements for determining the objectives and requirements of the subsurface exploration program.

### **4.3.1.1 Minimum Requirements for Subsurface Investigations**

The considerations of [section 4.3.1](#) do not preclude the necessity of established minimum requirements for subsurface investigations. The base level of investigation has value as an initial approach to a subsurface investigation and for preliminary cost estimation of exploration activities as well as assuring that some uniform amount of exploration is accomplished for all geotechnical design. The minimum standards for subsurface investigations are well defined in the 1988 *AASHTO Manual on Subsurface Investigations* and are broadly accepted in the practice.

Subsurface conditions are highly variable in Oregon. Because of this, there shouldn't be any hesitation to add explorations to the program due to the unpredictable nature of the state's geology. Much of the work performed during the preliminary office studies will assist in determining the overall scale of the subsurface investigation program.

Such added expenditures are always justifiable when additional exploration, testing, and analyses result in correlative savings on the construction cost and in an overall better geotechnical design.

### 4.3.1.2 Risk Tolerance

Further consideration in the development of the Exploration Plan should be given to developing an assessment of the risk tolerance of the project to unforeseen subsurface conditions. In this regard, an assessment of the risks assumed by the constructability and function of the design feature without the benefit of site-specific subsurface information should be conducted. The risk assessment should pay close attention to the potential for cost overruns during construction and potential for long-term maintenance or increased lifecycle costs. The cost of an over conservative design resulting from a hedge against unknown subsurface conditions is another aspect of risk that should also be evaluated. This is where a design is forced to be based on the worst possible condition known to be present or perceived at a site in order to prevent failure because the lack of information precludes the assessment of other alternatives. Generally, an evaluation of the potential risks at a project site occurs as exploration progresses and the variability of the subsurface is discovered.

### 4.3.1.3 Structure Sensitivity

The sensitivity of a structure or other facility in terms of performance to subsurface variability also influences the scale of the subsurface investigation. Consider the following in relation to structure sensitivity:

- Where settlement is concerned, structures are much more sensitive whereas embankments overall are able to tolerate more post-construction deflection notwithstanding those sections adjacent to bridges.
- Existing structures adjacent to transportation projects also increase the sensitivity of projects in the built-up or urban environment. Where construction is to occur adjacent to existing structures or private buildings, the tolerance for settlement or deflection and even vibration is essentially eliminated, and correspondingly, the need for subsurface information increases.
  - Such sensitivity can also extend to environmental, cultural, and archaeological sites where great efforts will be made to mitigate impacts during construction. For these circumstances, significant efforts in pre-construction through post-construction monitoring are often required with instrumentation installed far in advance of contract letting.
- Certain types of construction may also be more sensitive to unanticipated subsurface conditions such as drilled shaft installation where relatively small changes can result in a sizeable cost increase.

Despite the best efforts and most detailed subsurface investigations, every significant subsurface condition may not be discovered or fully examined. The objective here is to reduce the risks accepted to the barest minimum, and to have some understanding of the risks that will remain.

### 4.3.1.4 Subsurface Investigation Strategy

An important strategy when conducting the subsurface investigation is to complete the most important explorations first with the idea that the project schedule may change, funding may be terminated, or some other decisions made that preclude the completion of all the planned borings. From this standpoint, the important borings are those that:

1. Provide information about geologic hazards affecting the project or that require monitoring for mitigation design,
2. Provide the information that the engineer needs to design the most critical structures, and
3. Locations that provide the most amount of information for the lowest expenditure.

This approach to the subsurface investigation allows design to proceed in the event of the inevitable project schedule or other priority shifts that may have a more urgent need for geologic or geotechnical resources. It is quite common for a planned exploration to be interrupted by the needs of emergency repair work or other critical-path projects, and having these explorations complete first allows engineers to continue work on a project rather than having to wait for the emergency to pass before getting the information they need to continue so that the interrupted project doesn't become an emergency itself.

**Note:**

*We recommend referring to Section 7.4.1 AASHTO that provides additional items to consider in determining the layout of a project subsurface investigation in addition to prioritization of the explorations. This bulleted list describes key issues in determining importance and priority of explorations from locations to structures that they are intended for as well as the use of less or even more expensive methods for investigation that may be required.*

### 4.3.1.5 Schedule of Subsurface Investigations

The first step in any subsurface investigation is to initiate the required environmental permitting. Access for drilling equipment as well as the drilling itself is subject to the same environmental permitting requirements as the actual project construction. Region Environmental Coordinators shall be consulted regarding the necessary permits well in advance of the anticipated exploration. In some cases, obtaining certain permits can take astonishingly long periods of time. Permits are often required for reasons or circumstances that are not readily comprehensible to the Geo-practitioner. For these reasons, it is advisable to brief the Region Environmental Coordinator on the potential exploration activities at the project kick-off. Earlier if possible. Subsurface exploration shall not proceed until all permits are issued.

Subsurface investigations **should be** completed as early in the project as possible to allow sufficient time for geotechnical design, quantity estimation, and consideration of alternatives. Clearly, many of the project features must already be known to some degree before the Exploration Plan can be formulated. Right-of-way needs must be established to determine cut and fill slope angles and heights or the need for retaining structures. **Ideally**, the bridge type,

size, and location (commonly referred to as “TS&L) are known in order to obtain ground-truth information at the precise bent locations. For most projects this level of detail won’t be provided on time for delivery of the geotechnical design. Subsurface explorations will have to be located as close to the anticipated structure as possible. A second phase of exploration may be necessary if the actual locations are determined to be too far away from the exploration location for the data to be representative of the ground truth conditions.

### **Completion of Exploration Plan**

Because of these informational prerequisites, the Exploration Plan is usually completed soon after initiation of the DAP with a goal for completion set as early as practical. The target for completion of preliminary geotechnical recommendations is set for the end of DAP.

In order to meet this date, there will be less than optimal time to complete the subsurface investigation and provide the needed information to the geotechnical designer charged with making the preliminary recommendations.

Subsurface investigation performed during an Advance Investigation phase may be called for at any time prior to Project Kick-Off, particularly during the EIS phase depending on the size of the project or any other special requirements. These investigations are intended to develop project geotechnical constraints and/or to provide general information to assist in alternative route selection, and to address particular requirements of the EIS rather than to gain site-specific geotechnical design parameters. Preliminary subsurface investigation typically takes place on an existing state right-of-way readily accessible areas so there should not be additional time and money spent in acquiring permits of entry, building access roads and reclaiming sites.

### **Instrument Monitoring Periods**

An additional aspect of the subsurface investigation schedule that also needs to be determined is the requirement for instrument monitoring periods. These are particularly important as they commonly extend before and beyond typical project timelines.

- **Landslides:** Projects that involve landslide repair or evaluation are the usual reasons for broadening timelines. It is critical to monitor landslide movements over periods of time that include at least one calendar year to assess the nature of the landslide, evaluate the relationships between precipitation, groundwater, and landslide movement, and determine the correct slide geometry for stability analysis.
- **Groundwater:** It is also important to monitor groundwater for other construction applications throughout seasonal fluctuations to help determine actual construction-time conditions. Grading operations or excavations that would be made “in-the-dry” during certain times of the year may occur below the groundwater surface during other months. Every effort must be made to collect this information regardless of the time of year that exploration is conducted.
- **Post-construction monitoring:** Where post-construction monitoring is necessary, it should also be identified as early in the Exploration Plan development as possible. Critical structures in addition to landslides may require such instrumentation for quality assurance in addition to providing an assessment of long-term performance.

Contingencies should be made for the event of abnormal climate years that result in unrepresentative instrumentation results. Atypically dry years can result in poor results from inclinometers and piezometers. At no time shall landslide movement be induced to move in order to gain instrumentation results.

### 4.3.1.6 Exploration Sites

One of the primary factors affecting the schedule of the subsurface investigation program is providing access to drill sites. This includes acquiring the necessary permits as well as the actual physical occupation of the drill site.

**Note:**

*Preliminary borehole location should have taken place during the initial site reconnaissance and major requirements with respect to accessibility should have been identified at that time. Since access to certain drill sites requires a significant investment of time, it is necessary to start acquiring permits of entry, environmental clearances, and engaging contractors to build access roads or bring additional resources to move the drilling equipment.*

The geotechnical designer should clearly indicate the necessary borehole location tolerances to the field crews to assist in determining site access. When situating a borehole, consider the following:

- For some sites, a few extra feet of tolerance available will allow a borehole to be accessed with standard equipment or with minimal disturbance while at others, considerably greater efforts will be necessary to place the borehole at the precise location.
- Where the location of the exploration is crucial, it may be reasonable to mobilize specialty-drilling equipment.
- Several factors contribute to the amount of tolerance allowed for an exploration. Among these are the phase of the investigation for which the explorations are performed, in this case, the final design explorations would require the more precise location.
- The types of structure, expected subsurface conditions, and surrounding facilities also have more exacting standards for borehole placement.
- A spread footing on rock, or a tieback wall adjacent to and supporting an existing structure are examples of cases where relatively minor changes in the subsurface conditions have very serious consequences during construction and would therefore warrant the extra expenditure to precisely locate the explorations. In this case, the expenditure for mobilizing special equipment would be far exceeded by orders of magnitude from ensuing claims or even, litigation.

### 4.3.1.7 Right of Way and Permits of Entry

Determining the exact boundaries of the State's right of way during exploration planning is essential since this demarcation is very commonly not correlative to the highway centerline nor does it fall at a constant length perpendicular to it. Current right-of-way maps should be consulted to assure the correct property ownership at the exploration site or for any land that must be traversed by exploration equipment and personnel.

Permits of entry (also known as “Right of Entry Permits”) are required for any site exploration outside of the highway right-of-way whether the site is on private property or on public lands outside the jurisdiction of ODOT. For simple cases, these permits can be obtained by the geotechnical designer in charge of the exploration or other staff. For most circumstances however; these permits should be obtained by the Region’s Right of Way section. In either case, the region Right of Way section should be consulted prior to any entry onto **non-ODOT** property. A sample Permit of Entry Form is included in [Appendix 4-A](#).

Each permit of entry form should be accompanied by a site map showing the precise location of the exploration **and access route** with respect to property lines and any structures or features on the private property.

Considerable delay in the exploration timeline can stem from the permit of entry process. In many cases, property owners are unaware of upcoming transportation projects until a **right of way agent**, geologist or geotechnical engineer asks them for a permit-of-entry for exploration. Even if unopposed or unaffected by the project, the owner may be reluctant to sign a permit of entry for a variety of reasons.

Often, further explanation of the activity and its purpose will be all that is necessary, or just allowing extra time for consideration is all that is required, but will affect the exploration schedule nevertheless.

#### **How to Handle Problems Obtaining Access to Property for Field Investigation**

In some cases, landowners are particularly slow in granting access to their property for whatever reason and may even respond to a request for a permit of entry with a letter from their legal counsel. In these instances, **the Region right of way office should be contacted immediately** to take a lead role in negotiations to resolve the issue. Although the Agency has the statutory authority to access any real property for the purpose of survey or exploration, it is an exceedingly rare case for ODOT to exercise this authority for subsurface investigation. The cause for performing a subsurface investigation on such a property must be well founded and without feasible alternatives.

#### **Note:**

*When a property owner refuses permission to enter their property, then all further communication and resolution becomes the responsibility of the Right of Way Section and the project management. Under no circumstances should field personnel mention or discuss the State’s statutory authority to enter upon their property to complete the work, nor should they engage in any bargaining or make agreements other than those stated on the permit of entry form in exchange for access to their properties.*

#### **Obtaining Right of Way from other Real Property-owing Entities**

Other real property-owning entities will take more time in granting a permit of entry. Corporations, governmental agencies, mutually owned properties, and railroads all have different procedures and requirements for granting access. Corporations may sign permits of entry only from their main offices, governmental agencies may have lengthy policies and procedures for granting permissions, and mutually owned properties may have numerous non-resident owners that must all be contacted for their consent.

### **Railway Right of Way**

Getting permission to access railroad right of way is a special case and can be a particularly time-consuming undertaking. For local operators and short lines, getting access may be relatively straightforward. Some larger carriers have a lengthy process for handling permit of entry requests that can severely affect a project timeline. If exploration or access is needed on railroad right of way, the project timeline should be adjusted accordingly and alternatives sought wherever possible. Permit of entry requests for railroad right-of-way should be forwarded through the headquarters Right of Way section.

In the event that the state-owned railroad right of way must be accessed, contact [ODOT's Rail Section](#) to obtain that permit.

### **Limiting Site Impact**

When performing subsurface investigation on private property, all care must be taken to avoid and mitigate the site impact. Access to such sites should be planned with the smallest possible impact. Although some exploration sites will be completely removed during construction, there may be considerable time between then and the time of exploration. The responsibility for complete restoration of exploration sites is placed on ODOT by the same statute that provides legal access to those sites.

## **4.3.1.8 Utility Location/Notification**

Underground and overhead utilities in the project area must be identified and approximately located early in the Exploration Plan development. The presence of utilities may dictate the location of, or access to exploration points.

### **Warning:**

*Encountering underground utilities during site investigations can be detrimental to the exploration schedule and budget. Digging or drilling into underground utilities or contacting overhead power lines with drill rig masts or backhoe arms can be lethal. For these reasons, the exact location of all utilities must be determined before any equipment is mobilized to the project site.*

### **Utility Notification Center**

In Oregon, the law requires that the [Utility Notification Center](#) is contacted no less than 48 business hours prior to any ground disturbing operations. This includes all test pit excavation, drilling, and even hand auguring or digging.

### **Note:**

*The Utility Notification Center (or "One-Call" Center) can be reached at 1-800-332-2344, or on-line at <http://www.callbeforeyoudig.org/oregon/>*

The Utility Notification Center contacts all of the utility services with facilities in the location(s) provided to them based on their records. The individual utilities then dispatch their personnel or contractors to the site to locate and mark the positions of their facilities according to the instructions provided. The following occurs in relation to utility marking:

- The utilities are also required by law to locate their facilities within 48 business hours. If the utility operator does not have facilities near the proposed location site, he or she will mark it as such to indicate that it is safe to proceed. Otherwise, they will mark the approximate location of their facility in the requested vicinity.
- If the utility is close to the proposed exploration, prudence would dictate that the exploration be moved slightly to allow for errors in the utility location, and to further prevent the accidental contact with the utility.
- If the utility has not marked the requested area in the required period, they should be contacted prior to commencement of exploration to confirm that the utilities have been contacted, and that they do not have facilities in that area.

The utility operators are often hard-pressed to comply with the 48-hour requirement due to the sheer volume of utility locations – particularly during the summer months when numerous contractors are requesting them. Additional time may be required, so utility location with respect to projected exploration starting times should be planned accordingly. It is also important to look for any other utilities that might be operating in the area in case they are not in the records of the Utility Notification Center. Indications of other utilities are marked riser boxes, manholes, valves, and obvious illuminated structures such as street lighting and advertising. It is the responsibility of the project geologist to notify any other utilities operating in the project area.

#### **Procedures to Perform Prior to calling the One-Call Center**

The procedures for utility notification and location are relatively simple, but minor mistakes or overlooked information can result in unnecessary delay and risk to the utilities and the exploration personnel. The following steps should be completed and information gathered prior to calling the One-Call Center:

- All proposed exploration sites must be located and clearly marked in the field with a survey lath, painted target on the ground surface, or both. By convention, the survey lath and target should be painted white. Efforts should also be made to make the location as visible as possible for the utility locators such as using additional directional markers and survey flagging.
- Each exploration site should be numbered and labeled as either “proposed test boring” or “proposed test pit.”
- The nearest physical address or milepost, and the closest cross street should be recorded.
- The Township, Range, and quarter Section should also be determined.
- Latitude and longitude of proposed explorations

When contacting the One-Call Center, the following information will be asked by their operator:

- The caller’s identification number (one will be assigned if not already registered)
- For whom the work is being performed
- Who will be doing the work
- Type of work
- Alternate contact



- Location of site (number of exploration points, county, nearest city, address, cross street, township range, section)
- Marking instructions (typically a 25' to 50' radius from each stake or target)
- Presence of any overhead utilities

The operator determines which utilities are known to have facilities in that area and provide the list verbally along with the ticket number, which will be used to identify that particular work order. The operator provides the date and time at which the work should be able to proceed. Once this call is complete, the operator will then notify those utilities that will then dispatch their locators. ODOT geotechnical designers use **Utility Notification Worksheet**, [Appendix 4-B](#), to document utility location for future reference while on site.

### **4.3.1.9 Methods for Site Access**

Exploration equipment selected for the subsurface investigation should be matched to the site conditions. Truck-mounted drills are the most commonly available and are capable of accessing most sites with or without additional work and equipment. However, for many sites, access to boring locations can be difficult and even very complex in some cases. Often, the cost for mobilizing special equipment to a project site is more than compensated for in reduced site impact, reclamation effort, time and materials costs, and the additional personnel and equipment that might be needed. Frequently, the method of site access is selected based on one or a combination of desired outcomes whether time and cost, minimizing impact, equipment availability, or equipment capability.

#### **Truck-Mounted Drill Rigs**

Truck-mounted drills that are road-legal generally have limited off-road capability even when equipped with 4-wheel or all-wheel drive due to their size and weight. These types of equipment are best suited to work on paved or surfaced areas although they are capable of reaching many off-road locations “in the dry.” Because of their axle loading, they can rapidly become mired in wet or soft soils.

In order to use a truck-mounted drill in difficult conditions, access roads may need to be built using one or more additional pieces of equipment. In steep terrain, access roads may require substantial cuts and fills, and where soft ground is encountered, sizeable amounts of rock and geotextile will be needed to surface the road. Special mats or even plywood may be used to distribute the trucks weight over soft ground when accessing a boring location. In any case, such work can be expensive, time-consuming, laborious, and high-impact requiring significant reclamation work after exploration.

Truck-Mounted drills that are off-road capable may require lower-standard access roads, but still need these roads. If a significant amount of winching or vehicle towing is necessary, an alternative method of site access should be strongly considered, if only for safety reasons. The advantage of truck-mounted drill rigs is that they are usually the best-equipped and highest-powered pieces of equipment available, so if a particular type of drilling or deep hole is required, these may be the only option. For accessible sites, truck-mounted drills are usually the cheapest and fastest way to accomplish explorations since they can drive over a site, set up,

complete the boring, and move on to the next location with relative ease and with fewer support vehicles.

### **Track or ATV-Mounted Drill Rigs**

Many exploration drill manufacturer's product lines now include drill rigs mounted on a variety of track and rubber-tire ATV platforms with some of the same features and capabilities as their truck-mounted counterparts. In some cases, the drilling equipment is the same, and only the platform varies:

- **Track-mounted drill rigs:** Track-mounted drill rigs offer a much greater off-road capability and ability to access sites in rough terrain and soft ground. Although the track-mounted drill can reach difficult locations, some road building or at least clearing of trees and vegetation may be required, although to a much lesser degree, than their truck-mounted counterparts. A level pad upon which to set the drill may also need to be constructed. One of the drawbacks of track-mounted drills is that they require slightly more time for set up and moving between longer distances since they must be hauled to project sites on a flatbed truck or trailer. The presence of the trailer or large truck for hauling the drill may also prove to be another encumbrance when working in tight locations or those sites with limited parking or space for maneuvering a long truck and trailer combination. The types of tracks must also be appropriate for the site.

### **Note:**

*Older-style steel caterpillar tracks are ideal for traversing steep slopes with a soil cover, but will be harmful to pavements or landscaped areas. Newer developments with rubber tracks offer better traction on bare rock surfaces, and are less harmful to pavements and landscaping but should still be used with caution as their treads can still damage or scar most surfaces.*

- **ATV Mounts:** Typical ATV-mounts consist of "balloon" or other oversized rubber tires for use in soft ground or swampy areas. The advantage that such vehicles have over tracks is the lighter load per unit area and correspondingly reduced impact to sensitive areas such as wetlands, landscaping, private properties, etc. Because of their distributed load, these vehicles are more suited to soft or uneven ground applications rather than for sites where traction on steep slopes is most needed. Several manufacturers now produce ATV platforms with tractor-style tires that offer many of the advantages of tracked and "balloon" tires with respect to traction, impact, and load distribution.

### **Difficult Site Access**

A variety of site conditions and subsurface information requirements create substantial difficulties in reaching exploration sites whether in remote, environmentally sensitive areas, or restricted space in the built-up environment. Such obstacles can range from high-angle slopes and physical barriers to restricted work areas such as confined spaces (as defined by OSHA), limited work space due to objects or environmentally sensitive areas, and over-water work. Diverse methods are available to assist with difficult site access as well as drilling contractors that specialize in this type of work.

Methods and equipment for difficult site access are as varied as the sites themselves. The common factor that limits what methods can be used for certain applications is the weight of the equipment with the volume of the machinery also being a limitation.

- **Winching or dragging:** Much of this work in the past has been performed by skid or trailer-mounted equipment with some man-portable also employed in some areas. This equipment has been winched, crane-lifted, or dragged into place by other tractors. With the advent of track and ATV-mounted drills, winching and skidding drilling equipment into place is no longer necessary or recommended due to the amount of ground disturbance involved.
- **Cranes:** Cranes are often employed to lift equipment into tight work areas although the weight of many of these drill rigs necessitated very large pieces of equipment to move them and had their own space issues.
- **Specialized equipment:** Until recently, most of the skid or trailer-mounted and man-portable drill rigs had restricted power and capabilities. However, drilling technology has advanced to the point where smaller and lighter equipment is capable of performing heavier drilling tasks. Specialized difficult-access drilling contractors generally use their own customized equipment that comes with a specific platform, or breaks down into lighter compartmentalized sections that are reassembled at the boring location. Much of this specialized equipment is light enough to be transported while slung beneath a helicopter.

Most modern drilling equipment not mounted on a truck chassis, with the exception of some man-portable equipment, is capable of completing almost all geotechnical exploration tasks in the same amount of time as their road-legal counterparts. However, these drills will always be restricted by allowable axle loads during transport, and so they will always have a disadvantage with respect to their overall horsepower versus a truck-mounted rig that does not require a truck and trailer combination for roadway transport. This disadvantage is typically only manifest in very deep and/or large-diameter boreholes.

#### **Barge/Over-Water Drilling**

Foundation investigation for bridges commonly requires in-stream access to drill sites. To achieve this, barges or other platforms must be used to set the equipment over the foundation location. Over-water work will add extra details to a site investigation, and depending on the location, this can add extensive logistical complexity to a project.

- **Permitting:** Additional permits will be needed to conduct the over-water work from the [US Army Corp of Engineers](#) and/or the US Coast [US Coast Guard](#), and from the port authority or harbor master with jurisdiction over the waters in which the investigation is being conducted. An additional staging and launch areas must be identified where equipment can be loaded onto the barge, and where the crew can access the work site for daily operations. The appropriate equipment must also be selected for the site with respect to the currents, depths, river traffic, obstructions, and other details.
- **Launch site:** The site for initially loading and launching the drill barge must be of sufficient size for the type of equipment being used. The launching ramp should have

enough grades to provide enough draft for the barge. The facility will also need enough room to either drive or lift the drilling equipment onto the barge and to safely load and unload all other ancillary equipment and supplies. Scheduling the facility for loading and unloading may also be important at different times of the year. Some ports may only be available at certain times due to their ongoing cargo loading operations and public or commercial fishing ramps may be crowded during those seasons. A proximate and smaller location may be available for launching a skiff or other small craft to support the daily drilling operations and permit crew changes between shifts.

- **Drilling barge:** The barge and any other vessels used for the over-water drilling operations must also be selected and rigged for the conditions.
  - The drilling barge itself must be of sufficient size not only to support the weight of the drill and other equipment, but must also have enough deck space for whatever sampling and testing operations that will also be carried out.
  - The vessel used to transport the drilling barge should also be capable of moving the barge in all conditions of weather and current.
  - For work in very slow currents or standing bodies of water, the drill barge may be fixed in place by spud anchors or by lashing to a fixed object such as a driven pile or pier. Where stronger currents occur, whether stream or tidal, a larger vessel may be required to transport and anchor the drill barge during operations. Additional anchoring will be needed in such conditions.
  - Where water levels will fluctuate quickly during the conduct of drilling such as in tidal zones and downstream of large dams subject to rapid discharge, allowances must be made for the drill barge to move accordingly with respect to elevation. These operations will usually require the drill barge to use free-moving spud anchors that are also fixed to a more securely anchored vessel.
  - The access vessel or skiff must also be capable of operations in all conditions at the site.
  - Provision must be made for keeping track of elevation changes during tidal or current changes as this will profoundly affect the drilling operations.

**Note:**

*As a condition of the US Coast Guard and/or the Coast Guard permit, a licensed Marine Surveyor must be engaged to examine the equipment and the site conditions. This professional will then make recommendations concerning the equipment, personnel, and safe conduct of operations. Whether or not a Marine Surveyor is required, their inclusion for over-water work planning is highly recommended for the particular skills and efficiencies that they bring to this rather hazardous aspect of subsurface investigation.*

## 4.4 Exploration Management and Oversight

The daily field exploration activities on a project should be based primarily on the execution of the Exploration Plan. The Exploration Plan provides a framework for scheduling and adjusting field operations as needed. It will necessarily allow for enough flexibility to modify the subsurface investigation program as information comes in from the field.

- The Project Geologist should maintain a base-level subsurface model from the subsurface information as it is received in order to make the needed modifications.
- The Field Geologist/Drill Inspector will need to provide regular updates on the field activities and information gathered so that changes to the schedule and routine can be made expediently. With the advent of cellular telephones and increasing areas of coverage, field crews should only be a few minutes away from contact with the senior geotechnical designers to inform them of unanticipated field conditions and in turn, receive direction on how to proceed with the modifications.

Because of the costs of subsurface exploration and the rapid use of the data, it is imperative that the subsurface investigation is directly supervised by qualified and experienced personnel. All on-site personnel including drillers, field geologists/engineers, and testing specialists should be instructed and familiarized with the project objectives and their role in achieving those objectives. Special geotechnical or other problems that may be anticipated during exploration including contingencies for addressing them should also be conveyed. All field personnel should be instructed in their role concerning project requirements for schedules, environmental protection, and especially, site safety and health procedures. Field personnel should communicate frequently with project supervisors or geotechnical designers.

Regular transmission of field data such as boring logs, test data, field conditions, and daily driller's reports will streamline and economize the site exploration.

**Note:**

*Any unforeseen site changes, complications, and geologic or geotechnical problems revealed during the investigation that will affect the project scope, schedule or budget should be communicated to the Project Leader without delay. The geotechnical designer charged with the exploration program is responsible for immediately and succinctly informing the Project Leader of the nature of the problem, the expected remediation, and the anticipated impact to the project. The geotechnical designer should then be prepared to offer alternatives and their respective outcomes for the resolution of the problem.*

## 4.5 Subsurface Exploration Requirements

### 4.5.1 General

The 1988 AASHTO *Manual on Subsurface Investigations* is the basis for subsurface investigations conducted by ODOT. This manual provides guidance on the minimum amount of investigation for the various structures and geotechnical features constructed for transportation projects. The manual states however, in numerous places, that there can never be a set of specifications and guidelines that will determine the amount of exploration that must take place for every project. Each site has its own requirements for exploration that must be determined by qualified personnel exercising professional judgement.

**Note:**

*The number of borings, their distribution, sampling interval, and depths of penetration will always be determined by the underlying geology and the size and complexity of the project.*

Planning for the subsurface exploration will be based on past knowledge of the site and on the published and unpublished literature that was consulted during the project reconnaissance phase. However, even the most thoroughly studied sites will still reveal previously unknown conditions, and each exploration provides new information about it. In a sense, the site conditions are truly unknown until the exploration begins, and knowledge of it increases as the investigation proceeds so adjustments must be made in the field to economize the investigation while assuring a full investigation of the important geotechnical design elements.

## 4.5.2 Exploration Spacing and Layout

The layout of explorations on a project is determined by many variables. As previously discussed, the assumed complexity of the underlying geology and the type of facility typically dictate the exploration spacing. Consider the following:

- Where conditions are uniform and a considerable amount of previous, reliable work has been accomplished in a project area, exploration spacing may be increased.
- If the geologic conditions are complex and change significantly over short distances, then explorations will necessarily be conducted on a shorter interval.
- Facilities that will impart a heavy load or are more sensitive to settlement or other movements will also require a more detailed exploration.

The 1988 *AASHTO Manual on Subsurface Investigations* provides a range of exploration spacing for the various structures and features that are typically the subject of subsurface exploration.

These guidelines are modified for use within the State of Oregon where subsurface conditions at many sites warrant much tighter exploration spacing due to the highly changeable nature of the state's geology.

### 4.5.2.1 Spacing and Layout Strategies

Because transportation projects are typically linear, explorations tend to be channeled into a relatively straight and narrow corridor, and are often laid out only along the centerline of many features. This should be avoided as it most often results in poor development of the subsurface model. To avoid this, boreholes should be spread out to either side of the centerline to help determine the **attitude** of the underlying strata, the nature of the contacts (i.e. conformal or non-conformal), and other changes or irregularities across the subsurface profile. Exploration to reveal or characterize **geologic hazards** such as faults and landslides that affect the proposed project may necessarily be conducted outside of the proposed alignment(s). Material source or disposal site investigations normally take place far away from the project alignment and will have different exploration spacing criteria.

Take special care when conducting explorations in particular alignments and foundation locations. Certain geologic conditions, such as openwork cobbles and boulders, heaving sands, or highly fractured rock may bind exploration tools severely enough that the drill crew is unable to retrieve them from the hole where they subsequently form an obstruction during drilled shafts construction. In areas that experience high artesian pressures, improperly sealed

boreholes may form an undesirable conduit for groundwater to enter footing excavations, cut slopes, or cofferdams.

**Note:**

All borings shall be abandoned in accordance to Oregon Water Resources Department Regulations to prevent vertical water migration. Provision should also be made to extract bound drilling tools from the boring with special equipment.

The boring layout guidelines presented here are of a general nature and are intended for use in the preliminary location of site exploration points. The final exploration locations should be developed as the site investigation proceeds. Information must be incorporated into the Exploration Plan as it becomes available to assure the most complete, cost-effective outcome.

### 4.5.2.2 Embankment and Cut Slope Explorations

The maximum exploration spacing for embankment fills over 10 feet (3.05m) in height is 200 feet (61m). Where changeable conditions or problem areas such as those with soft and/or compressible materials are present, then the exploration spacing can be decreased to 100 feet (30m). In many cases it will be necessary to conduct additional exploration using cone penetrometers, hand augers, or backhoe test pits to further define the properties and boundaries of problem foundation conditions. At least one boring should be located at the point of maximum fill height.

For cut slopes 10 feet (3m) and higher, the initial boring spacing should be 100 feet (30m). Initial boring spacing may be increased on slopes with good exposure. Borings should be staggered to each side of the cut line to help determine the attitude of the units in the cut slope, and one of the borings should be placed at the maximum depth of the cut. For “through-cuts” where a cut slope will be located on each side of the roadway, boring spacing may be increased to 200 feet (61m) for each cut slope, but the borings must be staggered so that the total 100 foot (30) spacing continues along the length of the cut.

Additional borings will be required in areas of faulted, sheared, tightly folded, highly weathered, or other potentially detrimental conditions exist.

Hand augers, direct push (i.e., GeoProbe), air-track drills, test pits, geophysical surveys, and other alternative exploration techniques can be used to supplement the test borings in proposed cut slopes to determine the elevations of variable bedrock surfaces and depths to bedrock. Air-track drills may also be used to penetrate the bedrock surface to determine and further resolve the location(s) of weathered rock zones and other features within the proposed cut slope.

### 4.5.2.3 Subgrade Borings

Pavement design is a separate discipline from geotechnical engineering in ODOT practice. ODOT’s Pavement Services Unit should be contacted with regard to any subgrade or pavement design investigation criteria. The Pavement Services Unit is subordinate to the Construction Section and can be reached at <https://www.oregon.gov/odot/Construction/Pages/Pavement-Services-Index.aspx>.

In rare instances, subgrade investigations for small pavement projects are performed by Geology/Geotech rather than Pavement Services. The following guidance is intended for these types of projects.

Where relatively unvarying subsurface conditions are predicted and no other foundations or earthworks are expected, the maximum subgrade boring spacing should be 200 feet (61m). In areas where highly variably geology is predicted, the boring spacing should be decreased to 100 feet (30m). The types of paving projects performed by Geology/Geotech are generally small enough to fit within the common boring spacing recommendation. In these cases, the project geologist or engineer must exercise judgement on the level of investigation necessary for pavement design. If no subsurface data exists, it is reasonable to expect at least one boring to evaluate subgrade conditions. If unfavorable conditions are found, additional subgrade borings would be necessary to demarcate problematic areas.

Alternate exploration methods may be used in variable geologic conditions to supplement the borings and further resolve the characteristics and distribution of problematic materials and conditions. Such methods may include hand augers, push-probes, or GeoProbe. Several geophysical survey methods may also be appropriate for subgrade investigations to supplement the test boring information. Seismic reflection and electro-magnetic methods are commonly the best suited for determining material property boundaries and saturated or water-bearing zones.

Test pits are not typically recommended due to the potential introduction of soft areas in the subgrade where the pits were located. If necessary, this problem may be alleviated by the use of compacted granular backfill materials to abandon the test pits after exploration. The test pit spoils would then need to be disposed of off-site. Test pits should be limited in size to the extent possible to further alleviate the introduction of soft areas.

#### 4.5.2.4 Tunnel and Trenchless Pipe Installation Borings

Tunnel construction for highway projects in Oregon is rare; however, trenchless pipe installation is common. Tunnels and trenchless pipe installations share many common construction and design issues and are normally treated in a similar manner with respect to subsurface characterization and exploration. Borehole spacing requirements for tunneling and trenchless pipe installation are highly dependent on the site geologic conditions and topography. The soil, rock, or mixed-face conditions predicted will determine the borehole spacing as well as the type of exploration and testing conducted. The depth of the tunnel/trenchless pipe alignment will greatly influence the total amount of drilling required.

ODOT has not constructed a new highway tunnel since the 1960's. All tunnel work since then has been for maintenance, retrofit, or rehabilitation of some existing tunnel element. This type of work generally only requires visual observations/inspections, small cores of the liner, or geophysical methods. These are not typical subsurface investigations and not covered in this manual. If the agency is tasked with new tunnel design in the future, exploration criteria will be established at that time.



Borehole spacing for trenchless pipe installation should be determined by actual site conditions. These conditions should be identified as early as possible by preliminary site review, and in the case of larger projects, preliminary site investigations conducted during an Advance Investigation. Exploration spacing for trenchless pipe installation is site dependent due to the layout of a trenchless installation under a typical roadway section. A set distance between borings would be difficult to apply in most situations.

To assure adequate investigation of trenchless pipe installation, exploration spacing shall be:

- At least two borings for every installation located on opposite sides of the roadway. Since most trenchless installation occurs below fill sections, borings should be sited on or as close to the edge of the fill slope as possible.
- At least three borings for installations under Interstates, Freeways, or Expressways with wide medians. Borings are sited as close to the outer fill slopes as possible on opposite shoulders with the additional boring located in the central median.
- At least three borings for installations under Interstates, Freeways, or Expressways that are six lanes or wider with narrow medians or median barriers. Borings are located on opposite shoulders with the additional boring in an interior lane.
- Long trenchless installations parallel to the highway or crossing at highly skewed angles should follow AASHTO Soft Ground Tunneling requirements for boring spacing.

Where unanticipated, highly varied, or difficult conditions are encountered, additional borings should be advanced to further evaluate those conditions. Borings should also be placed at locations where deep boring/jacking pits are expected. Geophysical surveys may also be used in conjunction with the borings to further define the geologic conditions. Trenchless pipe installations under highways are one of the most sensitive and high risk projects for the agency that are also the most likely to have claims. For these reasons, the boring spacing's described above are bare minimums. Additional borings should be anticipated for every trenchless project.

#### 4.5.2.5 Structure-Specific Borings

The actual number and spacing for borings for specific structures varies greatly depending on the predicted geologic conditions and the complexity of the site. In this regard, nearby features such as streams and environmentally sensitive areas, geologic hazards, and nearby structures will further prescribe the actual amount of exploration required.

##### **Bridges**

For all bridges on ODOT projects, at least one boring shall be placed at each bent location. Where highly variable conditions are anticipated or encountered, at least two borings shall be placed at each bent location. Borings should be placed at opposite sides of adjacent bent locations (i.e. right or left of centerline) when practical as defined below.

- For bridges that are 100 feet (30m) wide and larger, at least two borings will be placed at each bent.
- If wing walls greater than 20 feet long are to be constructed, borings should be spaced according to Retaining Wall requirements described below.
- For drilled shaft foundations, 1 boring should be placed at the location of each proposed shaft of 10 feet (3.05m) in diameter and larger. Additional borings may be necessary for bents founded on multiple shafts. [Federal Highway Publication FHWA-NHI-10-016](#) should be consulted for exploration spacing at drilled shaft foundation locations using smaller diameter shafts.

### Culverts

All proposed new and replacement culverts require some level of subsurface investigation as defined below:

- Typically, culverts with a diameter of 6 feet (1.8m) and larger are investigated with test borings while smaller culverts are investigated with hand-dug test pits or hand auger holes. However, judgments should be made regarding the actual site conditions and the facility in question to determine the number, type and spacing of borings.
- Complex geologic conditions merit a more intense investigation, while larger embankments, adjacent facilities, and proximate unstable slopes may result in a more detailed investigation for smaller-diameter culverts.
- At least two borings should be completed for each culvert up to 100 feet (30m) long.
- For culverts longer than 100 feet (30m), borings should have a maximum spacing of 50 feet (15m) with borings located at each end.
- In complex geologic conditions, boring spacing may be decreased to 20 feet (6m). Borings will typically be located along the axis of the proposed culvert.
- For culvert replacements, the borings should be located immediately outside or partially within the excavation limits of the original culvert installation with particular care to not locate a boring where it will penetrate the existing pipe.
- Borings will typically be located along the axis of any proposed culvert location.
- Refer to [Section 4.5.3.4](#) for exploration spacing on culverts installed using trenchless technology.

### Retaining Walls

Retaining walls higher than 4 feet (1.2m) and any wall with a foreslope and/or backslope angle steeper than horizontal require a subsurface investigation. At least two borings are required for every retaining wall regardless of length with the exception of retaining walls less than 25 feet (8m) long. The typical borehole spacing along any retaining wall is 100 feet (30m). One boring is required at each end of the proposed wall. Where the proposed wall is longer than 100 feet (30m) long, and less than 200 feet (61m), the third boring may be placed at either the midpoint of the wall, or at the location of the maximum wall height. Borings may be added or subtracted based on the conditions encountered in the field. Embankments supported by retaining walls on each side should be investigated as two separate walls.

Borings are typically located on the wall alignment at the proposed location of the wall face however; they may be staggered to either side of the wall line but should remain within the wall footprint to evaluate the wall foundation conditions. Consider the following:

- For soil nail, tieback, and similarly reinforced walls, additional borings should be completed in the wall reinforcement zones.
- Borings should be located behind the wall in the predicted bond/anchorage zones for tieback walls, or horizontally 1 to 1.5 times the wall height back from the wall face **for soil nail walls.**
- Borings for tiebacks/anchors should be interspersed with the borings along the wall face. Thus, a 200 foot (61m)-long wall would have (at a minimum) 5 borings – 3 along the wall centerline at the ends and the midpoint and 2 in the prescribed locations behind the wall at the 50 foot (15m) and 150 foot (46m) points along the wall centerline.

The preceding recommended borehole spacing should be halved for walls that will be constructed to retain landslides. Landslide retaining walls should have a minimum of 2 borings along the wall line regardless of length. The maximum borehole spacing along such walls is 100 feet (30m) with corresponding holes interspersed between located in the bond/anchorage zone. These boreholes are specifically for characterizing the subsurface conditions at the location of the proposed retaining wall, and are in addition to any borings advanced to characterize the landslide. Landslide investigation borings may suffice for the retaining wall investigation only where they fall within the prescribed locations.

### **Sound walls, Traffic Structures and Buildings**

Sound walls and traffic structures, such as mast arm signal poles, strain poles, monotone cantilever sign supports, sign and VMS truss bridges, luminaire poles, high mast luminaire poles, and camera poles are common features on highway transportation projects. Buildings such as maintenance facilities, rest areas, pump stations, water tanks and other unique structures are also sometimes required for ODOT projects.

Standard drawings have been developed for sound walls and most of the traffic structures and these standard drawings contain standard foundation designs for each of these structures. Each foundation design shown on a standard drawing is based on a certain set of foundation soil properties, groundwater conditions and other factors that are described on the drawings. These soil properties and conditions must be met in order to use the foundation design shown on the standard drawing.

#### **Note:**

*The subsurface investigation for these structures (with standard foundation designs) should be sufficient to determine whether or not the subsurface and site conditions meet the requirements shown on the standard drawings. If the foundation conditions at the site are determined not to meet the subsurface and site conditions described on the standard drawings (e.g., “poor” soil conditions or steep slope), then the standard drawings cannot be used, and a site-specific foundation investigation and design is required.*

For buildings and traffic structures without standard foundation designs, the foundation conditions must be investigated sufficiently to determine the soil properties and groundwater conditions required for a site-specific foundation design.

All new sound walls, traffic structures, or buildings require some level of subsurface investigation. Considerable judgment is needed to determine which structures will need site-specific field investigations. If the available geotechnical data and information gathered from the site reconnaissance and/or office review is not adequate to make an accurate determination of subsurface conditions, then site-specific subsurface data should be obtained through a proper investigation. In these cases, explorations consisting of geotechnical borings, test pits and hand auger holes, or a combination, shall be performed to meet the investigation requirements provided. The extent of the investigation will be largely dependent on the predicted site conditions. At unfavorable locations, drilling and sampling may need to be conducted more frequently while sites with favorable conditions may allow for less frequent and/or less expensive investigation methods such as hand augers holes and test pits.

As a minimum, develop the subsurface exploration and laboratory test program to obtain information to analyze foundation bearing capacity, lateral capacity, stability, and settlement.

The following information is generally obtained:

- Geological formation(s)
- Location and thickness of soil and rock units
- Engineering properties of soil and rock units such as unit weight, shear strength and compressibility
- Groundwater conditions (seasonal variations and maximum level over the design life of the structure)
- Ground surface topography
- Local considerations, (e.g., slope instability potential, expansive or dispersive soil deposits, utilities or underground voids from solution weathering or mining activity)

Specific field investigation requirements for sound walls, traffic structures, and buildings are summarized in [Table 4-1](#). Note that the term “borings” in the table refers to conventional geotechnical boreholes while the term “exploration points” may consist of any combination of borings, test pits, hand augers, probes, or other subsurface exploration device as required to adequately determine foundation conditions.

Table 4-1 Specific field investigation requirements

Structure Type	Field Investigation Requirements
Sign, and VMS Truss Bridges, Monotube Cantilever Sign Supports, High Mast Luminaire Supports	<p>Investigate VMS sign and truss bridges with one boring at each footing location unless uniform subsurface conditions are sufficient to justify only a single boring. Where highly variable conditions occur or where the sign bridge footing is proposed on a slope, additional borings, or exploration points may be necessary.</p> <p>For single, isolated monotube cantilever signs; one geotechnical boring at each footing location.</p> <p>High Mast Luminaire Supports require a boring at each footing location.</p> <p>The depth of the explorations should be equal to the maximum expected depth of the foundation plus 5 ft.</p>
Mast Arm Signal Poles* Strain Poles* Luminaires* Camera Poles*	<p>Only a site review is required if the new structures are founded in new or existing embankments that are stable and known to be constructed of granular materials or general borrow and compacted in accordance with <a href="#">Section 00330.43</a> of the ODOT Standard Specifications. Otherwise, subsurface conditions should be verified using geotechnical borings and the Standard Penetration Test (SPT).</p> <p>Signal pole foundation lengths for SM 1 Through SM 5L are provided in Chapter 17 and do not require a subsurface investigation. Spread footings to support standard monotube sign/VMS structures 1 through 9 shown on Standard Drawing TM627 are also Standard Designs that do not require a subsurface investigation.</p> <p>For mast arm signal pole or strain pole foundations within approximately 75 ft. of each other or less, such as at small to moderate sized intersections, one geotechnical boring for the foundation group is adequate if conditions are relatively uniform. For more widely spaced foundation locations, or for more variable site conditions, one boring near each foundation should be obtained.</p> <p>The depth of the explorations should be equal to the maximum expected depth of the foundation plus 5 ft.</p>
Sound Walls	<p>For sound walls less than 100 ft. in length, a geotechnical boring approximately midpoint along the alignment and should be completed on the alignment of the wall. For sound walls more than 100 ft. in length at least 2 borings are required. Borings or exploration points should be spaced every 100 to 400 feet, depending on the uniformity of subsurface conditions. Where adverse conditions are encountered, the exploration spacing can be decreased to 50 feet. Locate at least one exploration point near the most critical location for stability. Exploration points should be completed as close to the alignment of the wall face as possible. For sound walls placed on slopes, an additional boring off the wall alignment to investigate overall stability of the wall-slope combination should be obtained.</p>

Structure Type	Field Investigation Requirements										
Building Foundations	The wide variability of these projects often makes the approach to the investigation of their subsurface conditions a case-by-case endeavor. The following minimum guidelines for frequency of explorations should be used. More detailed guidance can be found in the <a href="#">International Building Code (IBC)</a> . Borings should be located to allow the site subsurface stratigraphy to be adequately defined beneath the structure. Additional explorations may be required depending on the variability in site conditions, building geometry and expected loading conditions. Water tanks constructed on slopes may require at least two borings to develop a geologic cross-section for stability analysis.										
	<table border="1" style="margin-left: auto; margin-right: auto;"> <thead> <tr> <th data-bbox="626 667 971 772">Building surface area (ft<sup>2</sup>)</th> <th data-bbox="971 667 1291 772">No. of Borings (minimum)</th> </tr> </thead> <tbody> <tr> <td data-bbox="626 772 971 846">&lt;200</td> <td data-bbox="971 772 1291 846">1</td> </tr> <tr> <td data-bbox="626 846 971 919">200 - 1000</td> <td data-bbox="971 846 1291 919">2</td> </tr> <tr> <td data-bbox="626 919 971 993">1000 - 3,000</td> <td data-bbox="971 919 1291 993">3</td> </tr> <tr> <td data-bbox="626 993 971 1066">&gt;3,000</td> <td data-bbox="971 993 1291 1066">3 - 4</td> </tr> </tbody> </table>	Building surface area (ft <sup>2</sup> )	No. of Borings (minimum)	<200	1	200 - 1000	2	1000 - 3,000	3	>3,000	3 - 4
Building surface area (ft <sup>2</sup> )	No. of Borings (minimum)										
<200	1										
200 - 1000	2										
1000 - 3,000	3										
>3,000	3 - 4										
	The depth of the borings will vary depending on the expected loads being applied to the foundation and/or site soil conditions. All borings should be extended to a depth below the bottom elevation of the building foundation a minimum of 2.5 times the width of the spread footing foundation or 1.5 times the length of a deep foundation (i.e., piles or shafts). Exploration depth should be great enough to fully penetrate soft highly compressible soils (e.g., peat, organic silt, soft fine-grained soils) into competent material suitable for bearing capacity (e.g., stiff to hard cohesive soil, compact dense cohesion less soil or bedrock).										

\* Minor structures with Standard Design foundations generally do not require borings. The Standard Designs preclude the need to acquire site-specific design data on individual projects. These structures do however require enough information about the subsurface to 1) assure that subsurface conditions fall within the Standard Design criteria, and 2) determine if subsurface conditions will be problematic during construction. This information can be obtained by other methods including evaluation of existing information, hand auger, GeoProbe, or test pits. The cost-benefit for mobilizing drilling equipment specifically for these minor structures has to be evaluated against the risk during construction. If the cost of exploration approaches the potential mitigation cost during construction it is probably unnecessary.

In addition to the exploration requirements in [Table 4-1](#) (Specific Field Investigation Requirements), groundwater measurements, conducted in accordance with [Chapter 4](#), should be obtained if groundwater is anticipated within the minimum required depths of the borings as described herein.

### 4.5.2.6 Critical-Area Investigations

In areas where critical geologic conditions or hazards such as highly irregular bedrock surfaces, extremely weathered or altered rock, compressible materials, and caverns or abandoned underground facilities are predicted from detailed background study or preliminary exploration, it may be necessary to further investigate the area with additional explorations. Such investigations normally involve drilling on a grid pattern over the area in question. An initial, wider grid pattern may be selected to locate the area of most concern with a closer grid pattern used later to further characterize the area of concern. Grid pattern investigations may consist of hand auger holes, direct push holes, or cone penetrometers in addition to the more conventional test borings. Geophysical surveys may also be used to establish or refine the boundaries of the grid pattern investigation.

### 4.5.2.7 Landslides

The number and layout of test borings for landslide investigation depends upon the size and nature of the landslide itself and on the results of detailed site mapping and initial subsurface models based on the mapping. Since information about the subsurface is unknown initially, landslide investigation largely becomes an iterative process as new data obtained provides information that is used to further develop enough knowledge of the landslide to begin stability analysis.

The approach to landslide investigation is very complex and involves numerous techniques and procedures. This [section](#) is intended to convey a general sense of the layout of the borings needed for a “typical” landslide investigation.

Enough borings must be made initially to fully develop at least one geologic cross-section through the axis of the slide. Consider the following:

- As a minimum, there should be borings near the top, middle, and bottom of a known or potential landslide area. Ideally, the borings would be placed in the toe or passive wedge area (if applicable), at the head or active slide zone, the area of transition between the active and passive zones, and in the areas behind the headscarp and in front of the toe outside of the slide zone.
- For longer slides, space additional borings in the active and/or passive slide zones on 50-foot (15m) intervals.
- Place additional borings on a 50 foot (15m) interval in a line perpendicular to the direction of slide movement at the deepest zone of slide movement.

For investigation of areas of potential slide movement, a grid pattern of explorations are usually selected for preliminary identification and delineation of the affected area. The grid spacing is dependent on several factors. Usually, the predicted size of the landslide, results of remote

sensing, availability of previous data, and site access will primarily determine the spacing between borings. Where large areas would potentially be affected by landslide movement, a 200 foot (61m) square or staggered grid spacing is sufficient for preliminary identification.

### Subsurface Investigations on Unstable Rock Slopes

Subsurface investigations for unstable rock slopes are necessary when a significant amount of rock excavation is needed to accommodate highway realignment or an increased fallout area.

- Typically, the amount of information available at a large, accessible rock exposure is sufficient for minor slope modification, and of generally greater value than core drilling with respect to information concerning rock conditions.
- However, when significant modification of the slope is considered for realignment and/or rock fall mitigation, subsurface investigation is frequently needed to determine the rock character within the proposed cut, overburden thicknesses, groundwater conditions, three-dimensional character of the units (if unknown), and other important design and construction information.
- Drilling is recommended to assure continuous subsurface conditions throughout the excavated rock material.

The skilled geologist's interpretation of the outcrop generally provides enough information for rock slope design, but the changeable nature of the state's geology, and the need to assure subsurface conditions to prevent construction delays and claims is usually reason enough to gain the additional assurance of further subsurface data. This is not to state that drilling for a rock cut slope modification is automatic. The geotechnical designer must determine the cost-benefit of additional subsurface investigation based on the local geology and the risks involved.

#### **Note:**

*For the assessment of large **rock slides**, subsurface investigation should proceed in a similar manner to the approach to landslide investigations as described above. Some of the borings, or additional borings may be needed at prescribed orientations other than vertical to assess the projected failure planes.*

For projects where realignment or slope modification to increase the fallout area is needed, the investigation should be conducted according to the procedures for cut slope investigation described in [Section 4.5.3.2 Embankment and Cut Slope Explorations](#).

## **4.5.3 Exploration Depths**

Determining the required depths of subsurface explorations requires the consideration of many variables such as the size, type, and importance of the structure, and most of all, the underlying geology. Consider the following:

- The borings should penetrate any unsuitable or questionable materials and deep enough into strata of adequate bearing capacity where significant settlement or consolidation from the increased loads from the proposed structure is reduced to a negligible amount. The stress at depth added by the structure is usually taken from the appropriate tables and charts or determined using the **Boussinesq** or **Westergaard** solutions.



- All soft, unsuitable, or questionable strata should be fully penetrated by the borings even where they occur below an upper layer of high bearing capacity.
- Test borings should not be terminated in low-strength or questionable materials such as soft silt and clay, organic silt or peat, or any fill materials unless special circumstances arise while drilling.

### 4.5.3.1 Termination Depths

When competent bedrock is encountered, test borings may generally be terminated after penetrating 15 feet (4.5m) into it. Where very heavy loads are anticipated, test borings may be extended to a considerable depth into the bedrock depending on its characteristics and verification that it is underlain by materials of equal or greater strength. For most structures, it is advisable to extend at least one boring into the underlying bedrock even when the remaining borings are terminated in soils of adequate bearing capacity.

As with all other aspects of subsurface investigation, considerable professional judgment is needed to determine the final depths of planned explorations. Generally, previous subsurface information is needed to determine the approximate depth of the proposed borings on the Exploration Plan. Where this information is unavailable, general guidelines can be used to establish the preliminary exploration depths and quantities. These guidelines are outlined for specific geotechnical features in the following sections.

### 4.5.3.2 Embankment and Cut Slope Exploration Depths

For embankments of 10 feet (3m) or greater in height, the test borings should penetrate at least 2 times the proposed fill width depending on the final width of the roadway and the actual materials encountered. If suitable foundation materials are encountered such as dense granular soils or bedrock, the depth may be decreased up to a minimum depth equaling the height of the embankment. Where confined aquifers with artesian pressures or liquefiable soils are present, the exploration depth should be extended to fully penetrate these units.

Cut slopes with a depth of 10 feet (3m) or more should be explored to a minimum depth that is 15 feet below the lowest elevation of the proposed cut or to a competent layer. When bedrock is encountered in a cut slope boring, the boring should extend at least 15 feet below the finish grade of the cut. If groundwater is encountered, the borings should be extended far enough into the pervious stratum for the installed piezometer to evaluate groundwater conditions throughout the wet and dry seasons. Cut slope borings should be extended if sheared surfaces or other evidence of landslide susceptibility are encountered that could affect the performance or constructability of the finished slope.

### 4.5.3.3 Subgrade Borings

Where minor amounts of earthwork (cut slopes less than 10 feet (3m) deep) for the alignment profile are expected, test borings and test pits should extend 15 feet (4.5m) below the proposed final grade elevation. For fill areas less than 10 feet (3m) high, explorations should extend to 15 feet (4.5m) below the original ground surface unless questionable materials are encountered. If

soft, organic, or other deleterious materials are encountered in subgrade borings, the depth of exploration should be increased as necessary to fully evaluate those materials.

### 4.5.3.4 Tunnel and Trenchless Pipe Installation Borings

A “rule-of-thumb” for tunnel exploration is the amount of exploration drilling should be 1.5 times the length of the tunnel. This should be considered as a bare minimum for exploration cost estimating for tunnel/trenchless installation projects will shallow alignments in very favorable conditions, and does not include horizontal drilling along the tunnel/pipe profile. Clearly, the amount of drilling for any given length of tunnel/trenchless installation alignment is dependent on several factors that include, among others, the depth of the invert, diameter of the tunnel/pipe, geologic conditions, and contingencies. Typically, tunnel/trenchless installation borings should be extended at least 1.5 tunnel/pipe diameters below the proposed grade of the invert. It may be beneficial to further extend the borings to as much as 3 times the tunnel/pipe diameter as a contingency if the final tunnel/pipe alignment has not been determined. The depth of the borings should be increased further to evaluate any unforeseen or unfavorable geologic conditions encountered that may affect the tunnel or pipe design and construction. For critical or highly variable sites, horizontal borings should be considered along the tunnel profile because of the advantages of having a full-length representation of the actual tunnel/pipe horizon conditions.

### 4.5.3.5 Structure-Specific Borings

The guidelines for boring depths presented throughout Section 4.5.3 stem from structure-specific boring guidelines developed by AASHTO and other agencies. Follow these guidelines:

- Structure-specific borings should penetrate at least 15 feet (4.5m) into bedrock.
- For drilled shaft installations, the test borings should be advanced the greater of 20 feet or 3 times the shaft base diameter below the estimated shaft base elevation.

**Note:**

*The geotechnical designer must exercise judgment concerning the nature of the facility with respect to the total and economical amount of drilling needed for the specific structure. Borings for sound walls, small traffic structures, or culverts may not be required to obtain core samples in bedrock, but for bridge foundations, bedrock drilling would certainly be needed.*

### 4.5.3.6 Critical-Area Investigations

In those areas where unfavorable or critical geologic conditions are expected to have an adverse effect on the project design and construction, the explorations should be extended to a depth where those conditions may be fully evaluated. All problematic strata and areas of concern should be fully penetrated by the borings. It is advisable to extend the borings to greater depths rather than terminate them before the desired information is obtained. Borings should never be terminated in soft, organic, or any other deleterious materials that will adversely affect the project design, construction, or performance. Extra drilling in some borings is less expensive

than drilling additional borings or even remobilizing equipment to the site to obtain sufficient data for design.

### 4.5.3.7 Landslides

Considerable flexibility must be built into the Exploration Plan for any landslide, and particularly with respect to the depth of the explorations. Follow these guidelines:

- Typically, the cross-section drawn along the centerline of the landslide is used to develop the preliminary exploration depths.
- Circular, elliptical, or composite curves drawn from the headscarp to the toe bulge are projected onto the cross-section to show the possible depths of slide movement. These curves are commonly exaggerated to conservatively estimate the slide depth.
- The preliminary boring depths should extend 20 feet (6m) or more below the projected slide plane to assure that the zone of movement is fully penetrated, and to secure instruments below the slide plane for the best results.
- Firm, resistant strata, bedrock projections, and irregular surfaces will also affect the geometry of the slide plane, and subsequently, the final depths of individual borings.
- Landslide borings should always be extended to a depth that clearly identifies which materials are involved in the current slope movement, which underlying materials are presently stable, and the location of the slide surface(s). This is not only important to the development of a stability analysis, but will become important once again during construction when the precise locations of mitigation efforts will be determined. There is often a possibility that the observed landslide activity is an accelerated portion of a slower, deeper-moving landslide that may only be detected by instrumentation. For this reason, at least one boring should be extended far below the predicted slide surface to divulge such activity. Any Exploration Plan for landslide investigations should contain the flexibility to extend borings to considerable depth during the site exploration.

### 4.5.4 Sampling Requirements

Since the primary purpose of the subsurface exploration program is the collection of samples that are as closely representative of actual site conditions, the sampling requirements are typically the most stringent in the Exploration Plan. Particular care must be taken in their method of collection, measurement, handling, and preservation since field and laboratory testing results are so greatly dependent on the quality of the sampling. Sampling requirements are also subject to the same variables that affect exploration layout and depth.

- **Sampling interval:** Most Exploration Plans will have a set maximum sampling interval. For most ODOT projects, Standard Penetration Tests (SPTs) are taken, and samples retained, on 2.5-foot (0.76m) intervals in the first 20 feet (6m) of the boring, and on 5-foot (1.5m) intervals thereafter to the bottom of the hole or until rock coring begins. In addition to this minimum interval, samples should also be taken at each noted change in material or subsurface condition. Where thick, uniform strata exist, a wider sampling interval may be warranted however, this greatly depends on the extent of previous site

knowledge and project requirements. Where complex conditions and/or numerous strata exist, the length **between samples** may be **de**creased to a shorter sampling interval.

- **Sample collection:** Samples should be collected from each identified stratum, preferably from more than one boring to fully characterize each unit. In addition, undisturbed samples should be obtained from all fine-grained soil units encountered. It is frequently warranted to drill additional borings to obtain undisturbed samples in particular units that may have been missed by previous sampling intervals or to further characterize those units. Where a larger volume sample is needed, a variety of sampling methods and techniques can be utilized including oversized split-spoons, various coring methods, and Becker-hammer drills. Sampling techniques are discussed in the next section.
- **Continuous sampling:** Continuous sampling is beneficial in areas of changeable site conditions and underlying geology as well as critical zones for project design. The zones immediately below proposed foundation elevations should be sampled continuously in addition to the zones immediately above, through, and below projected landslide zones of movement. For tunnel/trenchless pipe installations, continuous sampling should be conducted for 1 tunnel diameter above and below the tunnel horizon as well as the tunnel horizon itself. Soil and rock coring is by its nature, a continuous sample, and is the most common method to obtain a continuous representation of the subsurface materials. However, continuous SPTs, Shelby Tubes, or a combination of these and other methods can be used.
- **Observation:** Careful observation and evaluation during drilling and logging of the recovered samples is essential to the entire exploration program. Much information can be obtained even when sample recovery itself is minimal.

#### 4.5.4.1 Soil Sampling for Corrosion Assessment

The corrosion potential of buried or exposed metal structures depends primarily on the electro-chemical nature of the soil and the presence of oxygen and moisture. An assessment of these properties and conditions is necessary to properly determine the corrosion potential of culverts and structure foundation materials. Electro-chemical tests provide quantitative information related to the aggressiveness of the subsurface materials and surface water environments. Electro-chemical soil testing typically includes testing for pH and resistivity and sometimes sulfate, and chloride contents. Surface water should also be tested in coastal regions where the potential intrusion of brackish (salt-water) water may occur in tidal streams.

Corrosion of culverts, steel piling and other buried structural elements is most likely to occur at or above the water table and in disturbed stratified soils such as man-made fills, especially those containing cinders, slag or ash. Guidance on the amount and extent of soil and groundwater sampling and testing for corrosion assessment is provided in the later chapters of this manual that are dedicated to specific structures.

Standard laboratory test procedures call for a relatively large sample. The amount of soil required for the laboratory testing can usually be obtained by a full 3" diameter Shelby tube.

Continuous oversize drive samplers will be necessary to obtain the needed quantities of soil in granular or dense soils.

### **Steel Culverts**

The electrochemical properties of the soil in which a culvert is placed are an important aspect of culvert design. Steel culverts are often subject to corrosion due to either the chemical nature of the soils surrounding the pipe or due to the acidity of the water flowing through the pipe. The ODOT Hydraulics Manual (Section 5.8.2) provides guidance on the soil sampling and testing necessary for metal pipe design. Bulk sampling of surficial soils in the immediate vicinity of the culvert, sufficient in quantity for testing, is standard practice. If subsurface explorations were conducted, with samples obtained for the culvert, additional electrochemical testing may be warranted.

Soil sampling and testing recommendations for steel piling corrosion assessment are described in [Chapter 16](#).

## **4.5.5 Sampling Methods**

Various sampling methods are described in this section. Many of the sampling methods are based on ASTM International standards located at [www.astm.org](http://www.astm.org) (the “ASTM Site”).

### **4.5.5.1 Standard Penetration Testing**

All Standard Penetration Tests must be performed according to [ASTM D 1586-99](#). The Standard Penetration Test (SPT) is the most common method for field testing and sampling of soils. Some variations with respect to standard intervals and refusal criteria occur throughout the industry however the fundamental procedure still adheres to the [ASTM](#) standard. The SPT uses the following methods:

- This sampling method uses the standard configuration 2-inch (5cm) outside diameter split spoon sampler at the end of a solid string of drill rods. The split spoon is driven for a 1.5-foot (0.45m) interval using a 140 Lb. (63.5 Kg) hammer dropped through a 30-inch (76cm) free fall.
- The number of hammer blows needed to advance the sampler for each 6-inch (15cm) interval is recorded on the boring log and sample container.
- The Standard Penetration Resistance or uncorrected “N”-value is the sum of the blows required for the last two 6-inch (15cm) drives. Refusal is defined as 50 blows in 6 inches (15cm) of penetration and recorded on the log as 50 blows and the distance driven in that number of blows.
- The hole is advanced and cleaned out between sampling intervals for at least the full depth of the previous sample.

This general procedure can be used with larger diameter samplers and heavier hammers for the purpose of obtaining additional sample volumes, but the blow counts do not provide standard resistance values. Prior to the commencement of drilling operations, the hammer energy must be measured to determine the actual hammer efficiency. This information is typically provided

by the drilling contractor and the calibration needs to be less than a year old at the time of drilling.

### 4.5.5.2 Thin-Walled Undisturbed Tube Sampling

Undisturbed samples of fine-grained soils should be taken with 3-inch (7.6cm) diameter Shelby Tubes according to the standard practice for thin-walled tube sampling of soils in [ASTM D 1587-00](#). This method obtains relatively undisturbed samples by pressing the thin-walled tube into the subject strata at the bottom of the boring. Thin-walled sampling is simply a method for retrieving a sample for laboratory testing. There is no actual field-testing involved with thin-walled sampling unless a Torvane or Pocket Penetrometer test is performed on the end of the sample. Pressures exerted by the drill rig while pushing Shelby tubes are frequently recorded for general reference but do not provide repeatable test results. After the unfavorable effects of the sampling procedure, transport, handling, and storage, a truly undisturbed sample is difficult to test in the laboratory. However, with appropriate care, valid samples can be taken for shear strength, density, consolidation, and permeability testing.

Shelby tubes do not utilize a sample retention system to hold the sample in place during retrieval from the borehole, so sample recovery can be unreliable. Thin-walled sampling in general is successful only in soft to stiff cohesive soils. Soils that are very soft are difficult to recover with standard Shelby tube while the upper range of stiff and very stiff soils are difficult to penetrate or bend the tube resulting in a disturbed sample. Oversized clasts and organic fragments in the softer soil matrix can also be detrimental to thin-walled sampling.

Various samplers that use retractable pistons to create a vacuum in the top of the tube can achieve greater success in obtaining undisturbed samples of soft cohesive soils as well as granular materials.

### 4.5.5.3 Oversized Split-Barrel Sampling

Oversized samplers are similar in configuration to the SPT sampling spoon but differ in their diameter and the inclusion of a ring liner to retain specimens. These samplers have been known by various names such as “Dames and Moore” or “Modified California” samplers but are now known by the sizes prescribed by the Diamond Drill Core Manufacturers Association (DCDMA), and range in size from 2 inches to 3.5 inches diameter. Oversized sampling should be carried out according to ASTM- D3550.

This type of sampler was originally developed for use in the arid states of the Southwest to sample unsaturated soils that cannot be penetrated by, or retained in Shelby Tubes. The primary advantage of these samplers is the ability to use ring liners to produce a relatively undisturbed sample when pushed into the soil or only struck a few times by the SPT hammer. Another advantage of these samplers is the recovery of a significantly larger sample. This is especially beneficial when performing electrochemical tests where a significant mass of soil is required for testing.

### 4.5.5.4 Rock Coring

Rock core drilling should be carried out according to [ASTM-D 2113-14](#). Successful core drilling is as much a skill as it is a test procedure. Experienced, conscientious personnel are necessary not only to run the equipment, but also to interpret the results of the drill action as well as the samples recovered. Material recovered may not actually represent the subsurface conditions present if not correctly sampled. Observation and interpretation of the drill action, fluid return, and other characteristics provide indications of the actual validity of the core sample as well as other information concerning the actual conditions in the subsurface.

**Note:**

*ASTM states that the instructions given in D 2113 cannot replace education and experience and should be used in conjunction with professional judgment. Qualified professional drillers should be given the flexibility to exercise their judgment on every alternative that can be used within the appropriate economic and environmental limitations.*

#### **Triple-tube Core Barrel Systems**

Because of the close-jointed, highly fractured nature of many rock formations in Oregon, and the detailed observations desired, rock coring should be performed with triple-tube core barrel systems that are best suited to such material. These systems provide the best recovery in difficult, highly fractured, and/or weathered rock, which is extremely important since discontinuity spacing, and weathering characteristics usually limit the strength of a rock mass with respect to foundation loading, or the performance of rock excavations. Triple-tube barrels provide direct observation of the rock core specimen in the split-half of the innermost tube as it is extracted from the inner core barrel. This allows accurate measurement of RQD and recovery and discontinuity attitudes prior to further specimen handling. Partial isolation of the sample in the inner split-barrel from the drilling fluids also preserves much of the discontinuity texture and infilling material that is also very important to rock mass characterization.

Most rock coring is performed with “H”-sized systems that provide core specimens with a diameter of  $2^{13/32}$  inches (61.1mm).

**Note:**

*Considerable degradation of sample quality can occur when using smaller diameter coring systems due primarily to drill action, particularly at greater boring depths; thus, H-sized core should be considered the minimum size for explorations.*

Larger diameter cores also provide a better assessment of discontinuity properties. There may be situations where smaller diameter coring is necessary such as difficult access sites where small equipment is needed that may not have the torque required to turn larger diameter casing. Core runs are typically made in 5-foot sections since this is the approximate length of most commonly available core barrels. Runs may be shortened when difficult drilling conditions are encountered. Longer barrels may also be used in highly favorable conditions such as quarry site investigations or other areas with uncommonly massive rock.

Rock core specimens should be preserved and transported according to the standard practice in [ASTM D 5079-02](#). Core specimens should always be extruded from the inner core barrel using the hydraulic piston system. The inner split barrel should not be manually rammed out of the inner barrel as this will result in sample disturbance. The core should not be dumped out of the end of the barrel either since this will also disturb the sample as well as invalidate some of the information.

### **4.5.5.5 Bulk Sampling**

Bulk sampling should be carried out at all pipe/culvert locations from the actual invert elevation when test borings are not required. The samples collected are submitted for the appropriate electro-chemical testing. Typically, bulk samples of 25 lbs. (11Kg) if impermeable bags are used, or 2 gallons (7.5 liters) for jar/bucket samples are collected from each discrete sampling site. Sample receptacles must be sealed to preserve natural moisture conditions. Bulk sampling may also be conducted for material source investigations and other surficial applications. All samples collected should be preserved and transported according to [ASTM D4220 / D4220M](#).

### **4.5.6 Sample Disposition**

Soil and rock samples collected during subsurface exploration should be transported to the appropriate ODOT region storage facility upon completion of the investigation. Soil samples are usually retained for only a short period of time after project construction since physical and chemical changes occur that, over time, invalidate the results of further testing regardless of any effort to preserve them. Rock core specimens are typically retained for 3 years after the final acceptance of the project or when the contractors and other concerned parties have been settled with provided that there are no problems with the performance of the facility. Specimens related to future construction activities should be retained. Under no circumstance will soil samples and rock core specimens that may have a bearing on an unsettled claim be disposed of until such claims are finally resolved.

### **4.5.7 Exploration Survey Requirements**

The actual location and elevation of all exploration sites shall be surveyed and plotted on the project base map. Once exploration is complete, the actual exploration site should be marked with a survey lath or painted target so that the survey crew can readily measure the intended location. The exploration number should also be marked in the field for accurate reference by the surveyors. Surveys should be completed based on the project coordinates in addition to the [WGS-84](#) datum. Elevations should be referenced to Mean Sea Level (MSL). Explorations are shown on the contract plans and must be accurately located by an OSBEELS licensed Land Surveyor.



### 4.5.8 Exploration Numbering

Every exploration shall be given a unique number that cannot be duplicated by exploration numbers on previous or future projects. Typically the project Key Number followed by a sequential number provides a unique number i.e. 07976-BH1, 07976-TP1, etc. Other systems may be used as long as a unique number is generated. This is a necessity for future use of ODOT explorations in a GeoDatabase.

## 4.6 Subsurface Exploration Methods

### 4.6.1 General

Many factors influence the applicability and selection of subsurface exploration equipment and methodology for any selected project site investigation. Selection of equipment and methods are usually based entirely on geotechnical data needs and geologic conditions but may also be based on site access, equipment availability, project budget, environmental restrictions, or a combination of any of these.

In many cases, trade-offs between expected results and the exploration method chosen must be evaluated to achieve the needed results within defined time limits and project budget constraints.

Geotechnical designers should be familiar with the exploration methods applied on their projects, and their results and potential limitations or effects on the data they receive from the field.

Most test borings conducted for transportation projects in Oregon are standard diameter vertical borings using rotary or auger drilling methods. Sampling within the boring is typically done by Standard Penetration Tests (SPTs), 3-inch (7.62cm) Undisturbed Shelby Tube samples, HQ3-sized rock coring, and auger coring. Additional, supplementary explorations are conducted using hand augers, direct push (i.e. GeoProbe) rigs, cone penetrometers, and test pits dug either by hand or more commonly with hydraulic excavators. ODOT is currently evaluating and using newer exploration technologies as they are developed or become increasingly available. The use of sonic drilling and geophysical methods are examples.

### 4.6.2 Test Boring Methods

The most commonly used drilling methods on ODOT projects are auger boring and rotary drilling. Continuous sampling core drilling is employed with both methods. Most modern drill rigs are capable of employing both of these techniques with only minor adjustments to the tooling in the field. Other techniques that are less commonly used are displacement borings using roto-sonic or percussion methods. Each drilling method should be selected based on the quality of information obtained in the materials for which the drilling method is best suited for, thus, selection of drilling technique should be carefully considered. Since most test borings penetrate many types of materials, several techniques are commonly employed in any single

test boring. Various institutions or individuals have strong preferences for certain types of drilling methods and will tend to use them as a “default” for almost any condition encountered. This behavior should be corrected or avoided. Almost every technique is capable of penetrating the subsurface or “making a hole.” The quality of the results is the purpose of subsurface investigation, and different drilling techniques are better suited to certain materials and conditions. Achieving quality results from a drilling program are more important than convenience.

### **4.6.2.1 Methods Generally Not Used**

Cable-tool, wash, jet, and air-rotary methods are generally not used on ODOT projects for many reasons. Cable-tool drilling may be useful for some environmental applications and well installations, but is generally antiquated and not productive for geotechnical investigation. Wash and jet borings cause down-hole disturbance well past the bottom of the boring, and the fluids are difficult to recover making them more of a liability than a source of data. Air-rotary drilling usually causes too much down-hole disturbance to provide reliable SPT data, and difficult to advance in soft soils. Groundwater typically stops further advancement of air-rotary drills, forms large voids, and casts sediment-laden water about the site. Air-rotary drilling may be suited to specific applications where known materials at a site are delineated based on the drill advance rate and obvious changes in the drill cuttings as they are flushed from the hole. In these applications, the air-rotary borings should be supplemental to standard geotechnical exploration borings conducted at the site.

### **4.6.2.2 Auger Borings**

Rotary auger drilling is one of the more rapid and economical methods of advancing exploration borings. Most modern drilling equipment has enough power to turn augers of considerable diameter to a substantial depth. Currently, most auguring uses a hollow-stem auger that allows the hole to remain cased while the various sampling or drilling tools are used and withdrawn from the hole with drill rods or wireline retrievers. A central “stinger” bit or plug is placed at the bottom of the auger while the boring is advanced. Solid stem auger use has largely been discontinued due largely to the advent of hollow stem augers and the more powerful equipment that is capable of turning their larger diameter drill string. The standard practice for using hollow-stem augers is described by [ASTM D 6151-15](#). Auger boring has many advantages and disadvantages for various materials encountered as described below.

#### **Auger Boring Advantages**

Auger boring has many advantages and disadvantages for various materials encountered. The primary advantages of augers are the preservation of the natural moisture content of the soil and the rapid advancement of the drill through soft to stiff soils. Augers are also useful where drill fluids are difficult to obtain or are an environmental concern, and in freezing conditions where the use of water is problematic. An additional advantage of augers is that they create a large enough hole to install larger-diameter standpipe piezometers or nested piezometers in conformance with [Water Resources Department](#) regulations. In addition, the natural

piezometric surface is more readily monitored during drilling. Coring tools are also available for auger systems that provide continuous sampling in soils and even weak rock materials. These tools can be placed by either rods or wireline into special auger bits that feed a continuous soil sample into a split barrel that is then retrieved in 2.5 or 5-foot (0.76-1.52m) sampling intervals. Plastic liners that fit in the auger core barrel can also be used to preserve soil cores in their natural moisture conditions.

### **Auger Boring Disadvantages**

The disadvantages of auguring are the power needed to turn long strings of auger in dense formations, the volume of the hole and the cuttings created, and the disturbance of the natural materials in certain conditions. When hollow-stem augers are used in granular soils below the water table, the hydrostatic pressure differential between the inside and outside of the auger casing will force saturated sands, silts, and fine gravels up into the casing effectively loosening the materials below the auger bit. This can be caused by either the natural differential, or by the pressure induced during retraction of the “stinger” bit or plug. The augers themselves can also affect the conditions of loose granular materials and silts ahead of the bit. In both cases, SPT values obtained will be different than what is true for the natural conditions. To counter this effect, a head of water, or other drilling fluid can be maintained in the auger casing to counteract these effects. Adding fluids to the auger generally negates their advantages and if such action is necessary, a different drilling technique should be employed. Hollow stem auguring should not be employed when assessing liquefaction potential.

A common complaint about auguring is the volume of cuttings generated. Where disposal is a concern, this is probably a disadvantage. However, when drilling in an environmentally sensitive area, auguring is often preferable because the cuttings are easily contained on site when drilling above the water table. A past complaint has also been the weight of the augers themselves although this has largely been negated by the more powerful equipment and the available wire line systems to assist with moving them around the site.

## **4.6.2.3 Rotary Drilling**

Rotary drilling is the most common, and usually the most versatile drilling method available. Various tools and products available for rotary drilling allow it to be adaptable to most drilling conditions and geologic materials. Rotary boreholes can be uncased holes advanced with a drill bit on rods or cased holes made with a casing, casing advancer and casing shoe. The casing advancer is a driver assembly with latches that fit in the bottom of the casing where it holds the center bit at the bottom of the hole and is subsequently retrieved with a wireline system. This method of drilling involves a relatively fast rotation speed, fluid circulation, and variable pressure on the drill bit to penetrate the formation, pulverize the formation particles at the bottom of the borehole. The circulating fluids carry these cuttings away from the bit, up the borehole annulus, and out of the hole.

When the desired sampling depth is reached, the drill rods or casing advancer are retracted from the hole and replaced with the desired sampling tool. The sampling/testing is conducted

while the hole is filled with fluid, retrieved from the hole, and then replaced once again with the drilling tool and borehole advancement continues to the next sampling depth. For uncased holes, the drilling fluid is relied upon to stabilize the borehole and prevent it from caving or heaving. In particularly weak or porous formations where drilling fluids are rapidly lost, cased holes are generally used. In uncased holes, the drilling fluid is usually recirculated from a mud tank or pit at the ground surface. Borings that use casing advancers typically use pure water that is not recirculated.

### **Rotary Drilling Advantages**

The advantage of rotary drilling is the relative speed of advancement in deep borings while maintaining borehole stability that best preserves in-situ soil conditions by counteracting soil and pore-water pressures in partially or fully saturated conditions. It is of particular advantage in very soft materials that are very sensitive to disturbance by the drilling equipment. Because of its ability to maintain natural conditions, rotary drilling is usually the best choice when conducting in-situ analysis such as vane shear and pressure meter testing. The trade-offs for rotary drilling is the introduction of moisture and other minerals that will influence the natural moisture conditions, and the difficulties with installing groundwater monitoring instruments although this later can in some cases be rectified by the use of special drilling fluids and by purging the borehole prior to installation. Special care is needed to contain drilling fluids during exploration, and for ultimate disposal that may involve transport off-site.

### **Drill Rods**

A variety of drilling rods, casings, and drill bits are available for various tasks. Most drilling tools come in standard sizes that are generally adaptable to one another. However, complexities arise when changing from one size to another when various thread sizes and configurations are used. Use the following information relating to drill rods and casing sizing:

- Drill rod and casing sizes are designated from smaller to larger by the letters R, E, A, B, N, and H. Drill rod outside diameters range from 1<sup>3/32</sup> inches (27.8mm) for R-sized rods to 3.5 inches (88.9mm) for H-sized rods.
- Drill casing outside diameter sizes range from 1<sup>7/16</sup> inches (36.5mm) for R-sized casing to 4.5 inches (114.3mm) for H-sized casing. Additional letters such as HW or NWJ designate different thread or coupling configurations.
- Complete tables of drilling tool types, sizes, weights, and volumes are available from the drilling suppliers and manufacturers.
- The important aspects of tool size is that the larger diameter, heavier drill sizes generally provide a more stable hole and allow a greater variety of testing and sampling tools to be used. These larger sizes also help control the eccentric movement of longer drill strings, reduce vibration at the drill bit, and help the driller maintain a straight and plumb boring.

The Diamond Core Drill Manufacturers Association (DCDMA) has standardized the drill rod and casing sizes although any number of other sizes and types remain on the market or are frequently introduced.

### Drill Bits

The choice of drill bit greatly influences the test boring quality and speed of completion. Rotary drill bits come in a variety of different types, each suited to a particular soil and/or rock composition. Driller preference is usually what determines what type of bit is used.

Experienced drillers can and should normally be relied upon to select the appropriated bit.

Certain drill bits are intended for specific geologic materials, but many drillers, through their experience and specific equipment, are able to achieve superb results with bits that are not usually used for that type of material. Follow these guidelines when using drill bits:

- **Soft or loose soils:** Soft or loose soils are usually drilled with drag bits. These bits have two or more wings of either tempered steel or carbide inserts that act as cutting teeth.
- **Hard soils and rock:** Roller bits are used to penetrate hard soils and rock. Roller bits may consist of hardened steel teeth or carbide “buttons.” Typically, steel teeth are sufficient for hard soil drilling while carbide button bits are used for bedrock drilling or for drilling in formations with numerous boulders and potential obstructions.

### Rotary Drilling Fluids

Various admixtures are available for mixing with the drilling fluids in different applications. Usually, the drilling fluid or “mud” is a mineral solution (usually bentonite and water, thus, a colloidal fluid) with a viscosity and specific gravity that is greater than water. These properties allow the fluid to better stabilize the borehole, cool and lubricate the bit, lift the cuttings out of the hole, and can also increase sample recovery. Various chemical and mineral additives may also be added to the mud mixture for the site-specific conditions. Certain chemical additives, such as pH stabilizers and flocculants, are introduced for common groundwater or mineral conditions that are the source of particular drilling difficulties. Mineral additives, such as barite, may be used to further increase the specific gravity of the mud for unstable boreholes and zones of high artesian pressures. Other additives inhibit corrosion of tools; seal off highly fractured or porous formations to prevent fluid loss, increase the suspension, and entrainment of sediments to flush the borehole, and numerous other applications.

Fluids or “mud mixtures” can greatly enhance rotary drilling, and in some very difficult drilling situations, is the only way to complete borings. Mud mixing should be treated with care as improper materials and quantities can actually be detrimental. Volumes and weights should be carefully measured and fluid density and viscosity should be monitored during borehole advancement as these properties will be affected by the formation materials. Several batches may be needed for individual borings depending on the depth of the borehole and other conditions.

The [U.S. Bureau of Reclamation](#) and the [USDA Natural Resources Conservation Services](#) have established general guidelines for drilling mud mixtures including amounts of dry materials, volume of water, and fluid densities. [Active Standard ASTM D4380](#) describes the procedures for determining the density of bentonitic slurries that can be used in rotary drilling.

## 4.6.2.4 Rock Coring

Rock core sampling is used to obtain a continuous, relatively undisturbed sample of the intact rock mass for evaluation of its geologic and engineering characteristics. When performed appropriately, core drilling produces invaluable subsurface information. Rock coring procedures have generally remained the same since the advent of the technology: a steel tube with a diamond bit rotated into the rock. Advancements in the bits, core barrels for retrieving the samples, and improvements to mechanized equipment overall have greatly enhanced this method.

### Note:

*Rock core drilling procedures and equipment has largely been standardized by [ASTM D2113-14](#). The Diamond Core Drill Manufacturers Association (DCDMA) has also standardized bit, core barrel, reaming shell, and casing sizes similar to drill rods.*

Rock coring almost exclusively involves the use of diamond bits, thus the terms “rock coring” and “diamond drilling” are used interchangeably. Selecting the proper drill bit for the rock coring conditions is essential. Sample recovery and drill production is dependent upon it. The ultimate responsibility for bit selection is the driller’s, however, it is important to be familiar with bit types to help determine recovery problems in the field since they may actually be unrelated to the drilling method. The actual configuration of the drill bit is selected based on the actual site conditions. The cross-sectional configuration, kerf, crown, and number of water ports are all determined by the anticipated conditions and characteristics of the rock mass. Consider the following:

- Incorrect bit selection can be extremely detrimental to core recovery, production, and project budget.
- Typically, a surface-set bit consisting of industrial diamonds set in a hardened matrix is used for massive rock bodies.
- Larger and fewer diamonds in the set are used for soft rocks while smaller and more numerous diamonds are used in hard rock. Hard rock bits commonly have a rounded or steeply angled crown.
- Flat-headed bits are usually for very soft rock. Impregnated bits consist of very fine diamonds in the matrix and are generally used for soft, severely weathered, and highly fractured formations. Some carbide blade and button bits are used for soft, sedimentary rocks. These are ideally suited for soft rocks with voluminous cuttings that require a considerable amount bit flushing and cutting extraction.

### Core Barrel

The core barrel is the section of the drill string that retains the core specimens and allows them to be retrieved as a whole section. Core barrels may be of different types and sizes, and may consist of numerous components that may be changed depending on the rock mass condition. Core barrels have evolved greatly over time. Single-tube barrels were originally used and required the entire drill string to be retracted to withdraw the sample. These have evolved through double-tube systems of either rigid-types where the inner tube rotates with the outer

barrel, or swivel-types where the inner tube remains stationary. Most core barrels used today are triple-tube systems that employ another non-rotating liner to a swivel-mounted double core barrel. This split metal liner retains the sample during extraction that allows minimal sample handling and disturbance prior to measurement and observation. Where desired, a solid, clear plastic tube can be used in place of the split metal tube. Single and even double-tube coring system often require a considerable amount of effort to extract the cores from the barrel that can result in detrimental sample disturbance.

Consider the following:

- Available triple-tube coring systems usually provide specimens that range in diameter from  $1^{5/16}$  inches (33.5mm) for “B”-sized core to  $3^{9/32}$  inches (83mm) for “P”-sized core.
- Larger core sizes are also available from rather specialized systems.
- A substantial penalty on the quality of rock structural information results from smaller diameter cores. Most rock core taken is “H”-sized ( $2^{13/32}$  inches, 61.1mm) in diameter.
- The use of smaller N-sized cores may be necessary in difficult access, or very deep drilling applications.
- The difference in RQD measurements between single, double, and triple tube systems are substantial.

### Specialized Methods

These specialized methods are also used:

- **Oriented core barrels:** Orienting core barrels can be used to determine the true attitudes of discontinuities in the rock mass. These specialized core barrels usually scribe a reference mark on the core as it is drilled. Recording devices within the core barrel relate the known azimuth to the reference mark so that the exact orientation of the discontinuities can be determined after the sample has been retrieved.
- **Borehole camera surveys:** Borehole camera surveys are used to determine discontinuity orientations. Several methods for both oriented coring and down-hole surveying have evolved, and highly trained personnel are typically needed to operate them successfully. The 1988 AASHTO Manual is a good source of information on the older core orientation systems while vendors such as the Baker-Hughes Corporation have technical information on the newer magnetic/electronic core alignment systems.

## 4.6.2.5 Vibratory or Sonic Drilling

Sonic drilling may be called vibratory or roto-sonic drilling. This type of drilling is used for continuous sampling in unconsolidated sediments and soft, weathered bedrock. It is best suited for use in oversized unconsolidated deposits enriched with cobbles and boulders such as talus slopes, colluvium, and debris flows or any other formation containing large clasts.

### Benefits

- The primary benefit of this method is recovery of oversized materials in a continuous sample, rapid drilling rate, reduced volume of cuttings, and fast monitoring well installation.

- This drilling technique is 8 to 10 times faster than hollow stem auguring and produces about 10% of the volume of cuttings.

### **Drawbacks**

- The drawbacks to this method are that it is typically more expensive, and cannot penetrate very far into bedrock.
- The vibration of the drill stem during borehole advancement may disturb the subsurface materials for an unknown distance ahead of the bit, and soft, loose materials can be liquefied during sampling.
- The vibrations can split or pulverize, the soil fragments, leading to a potential underestimation of material size.
- The sample size and speed of extraction will require additional personnel to process, log, and classify in the field.

Sonic drill rigs use hydraulic motors that drive eccentric weights to oscillate the drill head. The oscillation generates a standing sinusoidal wave in the drill stem with a frequency that can be varied depending on the materials encountered. The drill head also rotates the drill stem. An inner and outer casing is advanced so that the hole can be cased at the same time that samples are collected. During drill advancement, the sample is forced into the inner casing from which it is retrieved on a set interval. SPTs and Shelby tube samples can be taken between runs of rotonic coring.

## **4.6.2.6 Becker Hammer Drilling**

Becker hammer drills are specifically for use in sand, gravel, and boulders. Some Becker hammer drill operators may also have a scoring system that can also be run for limited applications. Becker hammer drills use a small diesel-powered pile hammer to drive a special double-walled casing. The casing can be fitted with an array of toothed bits depending on the application. An air compressor forces air through the annulus between the casings to the bottom of the hole where it extracts the materials up through the center of the innermost casing, through a cyclone, and into the sampling bucket. The materials can be extracted on a set interval as the driller engages the air compressor. The Becker drill casings range in size from 5.5-inch (14cm) to 9 inches (23cm) for the outer casing, and 3.3-inch (8.4cm) to 6 inches (15.2cm) respectively for the inner casing. This size of casing allows retrieval of relatively large, unbroken clasts. As the drill is advanced, blow counts are taken along with measurements of the hammer's bounce chamber pressure. Becker hammer drill data can be correlated to the soil density and strength in coarse-grained soils. In addition, SPTs can be taken through the inner casing of the Becker hammer string.

## **4.6.2.7 Supplemental Drilling/Exploration Applications**

A wide assortment of exploration techniques are available to supplement the subsurface information gathered from test borings at a project site. Typically, any method that can be employed to properly evaluate the subsurface conditions in a supplementary capacity is acceptable on an ODOT project if not constrained by environmental considerations. These



methods are usually the most simple and economic to quickly gather subsurface information with minimal cost. In some cases, more extensive and costly methods are required to obtain critical design information. Generally, supplemental investigations consist of simple hand auger borings or backhoe test pits to gather more detailed information and collect additional samples in near-surface or overburden materials.

### **Hand Tools**

Hand augers are available in many forms that allow rapid penetration of near-surface soils and collection of representative samples. Various bits can be used that are suited to general soil conditions that help penetrate and retain samples from certain materials. Extra sections of rods can be added to extend the depth range of these tools. Small engine-powered augers can also be used to increase the depth of penetration and to reduce the physical workload. Most hand augers are of sufficient diameter to permit undisturbed Shelby-tube sampling in the boring where soft soils are encountered. Additional tools such as jacks, cribbing, and extra weights may be needed to retract the tube after sampling. Most field vehicles are equipped with shovels that geotechnical designers can apply to subsurface investigations. Hand-excavated pits can provide essential, detailed information on the near-surface environment.

Various hand probes and penetrometers can be used to make soundings of soft material depths and delineate underground facilities in soft ground conditions. Hand auger borings and hand-excavated test pits are often required for collection of bulk samples.

### **Cone Penetrometers**

Cone penetrometers can be operated from most drill rigs, or they may come as a separate vehicle specially rigged for cone penetration testing. The cone penetration test (CPT) is conducted by pushing an instrumented cylindrical steel probe at a constant rate into the subsurface with some type of hydraulic ram. The cone penetration test is very advantageous in certain (usually soft) soil conditions as it provides a continuous log of stress, pressures, and other measurements without actually drilling a hole. CPTs can be conducted with a transducer to measure penetration pore pressure. Additional instrumentation can be used to measure the propagation of shear waves generated at the surface. Standard cone penetration test procedures are described in [ASTM D 3441-98](#). Electronic CPT testing must be done in accordance with [Active Standard ASTM D5778](#).

### **Percussion or Direct push (i.e. GeoProbe®) Borings**

Direct push drills are hydraulically powered, percussion/probing machines originally intended for use in environmental investigations. The direct push method uses the weight of the vehicle combined with percussion to advance the drill string. Drive tools are used to obtain continuous, small-diameter soil cores or discrete samples from specific locations. Direct push drills can obtain continuous samples through the soil column and are capable of penetrating most soils up to about 100 feet (30m). Small-diameter piezometers can also be installed through the direct push tools. Direct push rigs are quick and economical to mobilize and sample the soil column very quickly. Their small diameter and method of penetration produce few if any cuttings that

must be disposed of. The percussion advance of the direct push method produces a considerable amount of sample disturbance.

**Note:**

*Direct push advancement rates may provide a relative determination of soil density with respect to material encountered by that particular machine but it is not correlative to SPT data. Direct push rigs are lighter and less powerful than most conventional drill rigs. Thus, they do not have the ability to penetrate certain formations, and because of the effort in doing so, may give a false, overestimation of the formation density.*

**Test Pits**

Backhoe-excavated test pits or trenches are commonly used to provide detailed examination of near surface geologic conditions and to collect bulk samples. Test pits allow examination of larger-scale features that would not be visible in standard borehole samples. Features such as faulting, seepage zones, material contact geometry and others are readily measured in test pit walls. In addition, Torvane and pocket penetrometer tests can be performed in the walls and floor of the test pit. In-place percolation testing can also be carried out in test pits. Test pits have the advantage of the shear bulk of materials that can be observed. In this regard, the overall composition of the materials in a unit are better assessed by the many cubic feet of material excavated and observed opposed to the relatively minute amount of material contained in a split spoon sampler.

**Warning:**

*Under no circumstances will personnel enter a test pit deeper than 4 feet (1.2m) below the ground surface unless the appropriate shoring and bracing is used. If any evidence of instability or seepage is evident in the test pit walls, no entry will be permitted until shoring is complete. Test pits must be filled in as soon as they are completed to prevent passersby from entering or falling in. When a test pit is used for percolation tests or for assessment of trench stability, appropriate barricades and signs must be placed around the site to prevent accidental entry.*

**ODEX or Air-Track Drilling**

Percussive air drilling is typically used in a similar manner to other probing systems with the exception that air-drill holes are used to probe harder materials. A relative rate of advancement coupled with the cuttings retrieved in certain intervals allows basic interpretation of subsurface conditions. ODEX systems using an outer casing allow installation of instruments below the water table that would otherwise be impossible to install with other air-driven equipment. The advantage of this method is the speed of installation and borehole advancement. As previously described, air drilling systems are not suited for standard testing methods due to the unknown amount of down-hole disturbance.

## 4.6.3 Alternative Exploration Methods and Geophysical Surveys

Alternatives to drilling and test pit excavations characteristically involve the use of geophysical methods. For ODOT projects, geophysical survey results are always supplemental to direct observation of subsurface conditions by borings and test pits and should never be considered as a replacement.

Geophysical surveys play an important role in engineering geology and geotechnical engineering however they do not provide all of the information needed for the development of geotechnical design parameters.

**Note:**

*From a liability and construction claims standpoint, direct observation, sampling, and testing are critical. Direct observation and measurement will assure that subsurface conditions not measured by geophysical survey methods are revealed and further support or refute the results of geophysical surveys.*

Most of the data obtained from a geophysical survey require an experienced and highly trained geophysicist to interpret and process before it is of any use to an engineering geologist or geotechnical engineer. Geophysicists can base their interpretation on direct calculations, tabulations, or regression analyses, or they may base it wholly upon their own experience. Any geophysical method used has its own aspects that can result in serious misinterpretation or inappropriate use of the results. Prior knowledge of the actual site conditions and the possible errors of the survey technique are needed to calibrate, or fit the data to the known baseline data.

Geophysical survey results and resolution of the data is dependent upon the density of measurement points, and frequency of measurements. These variables may be set according to the overall project needs and level of detail required. Modern geophysical instruments are sensitive enough to produce measurements at the levels needed for geotechnical investigations. Methods most frequently used are:

- Seismic methods are the most commonly conducted techniques for engineering geologic investigations.
- Seismic refraction provides the most basic geologic data by using the simplest procedures, and commonly available equipment. The data provided is the most readily interpreted and correlated to other known material properties.

## 4.7 Geotechnical Instrumentation

### 4.7.1 General – Instrumentation and Monitoring

Of equal importance to site characterization and exploration as sampling and testing data is the information provided by geotechnical instrumentation and monitoring. Sampling and testing of materials provides needed design information concerning the existing site conditions at the time of investigation. Information regarding certain site conditions as they change through time

due to the effects of natural variations in the earth's surface and atmosphere or the effects of human activities, such as construction, can be provided by the appropriate selection, installation, and monitoring of geotechnical instruments. Most geotechnical instruments are used to monitor the performance of structures and earthworks during construction and operation of the facility. Some instrumentation programs are planned to provide actual design criteria such as landslide depths of movement and piezometric surfaces. Other programs are intended to verify design assumptions. In any case, considerable design and planning efforts are needed to derive the needed results. Geotechnical instrumentation has become much more "user-friendly" as technologies have developed, but an all-inclusive process beginning with a determination of the instrumentation project objectives that are carried through to completion and use of the data.

## **4.7.2 Purposes of Geotechnical Instrumentation**

A rule of thumb for geotechnical instrumentation programs is: "every instrument installed should be selected and placed to assist in answering a specific question." The point of this rule is to start a geotechnical instrumentation program on the correct course of study to acquire the necessary results with the greatest efficiency. Instruments can have an initially high installation cost, but the time and effort for reading them and making sense of the results **is** where the **highest costs and efforts** occur. Any instrument installed will provide some information; whether or not it is relevant to the immediate project requirements is the issue. Therefore, efforts must be concentrated on the primary questions to gather the most important data from the instrumentation program without time lost to the analysis of extraneous data.

### **4.7.2.1 Site Investigation and Exploration**

Instruments are regularly used to characterize the initial site conditions during the design phase of a project. Landslide remediation projects rely on instruments to determine depths and rates of movement as well as pore water pressures to provide basic information for stability analysis and mitigation design.

Most project sites require some information concerning the actual depth and seasonal fluctuation of groundwater that not only affects the project design, but also its constructability.

### **4.7.2.2 Design Verification**

Instruments are frequently used to verify design assumptions and to check that facility performance is as expected. Instrument data gathered early in a project can be used to modify the design in later phases. Geotechnical instruments are also an inherent part of proof testing to verify design adequacy.

### **4.7.2.3 Construction and Quality Control**

Geotechnical instruments are commonly used to monitor the effects of construction. Construction procedures and schedules can be modified based on actual behavior of the project features for ensuring safety as well as gaining efficiency in the actual construction as

determinations can be made regarding how fast construction can proceed without the risk of failure or unacceptable deflections. Instruments can be used to monitor contractor performance to assure that contract requirements and specifications are being met.

#### 4.7.2.4 Safety and Legal Protection

Instruments can be used to provide early warning of impending failures allowing time to isolate the problems and begin implementation of remedial actions. Instrument data provides crucial evidence for legal defense of the agency should owners of adjacent properties claim that construction or operations have caused damage.

#### 4.7.2.5 Performance

Instruments are used for the short and long-term service performance of various facilities. Deformation, slope movement, and piezometric surface measurements in landslides can be used to evaluate the performance of drainage systems installed to stabilize the landslide. Loads on rock bolts and tiebacks may be monitored to assess their long-term performance or evaluate the need for additional supports.

### 4.7.3 Criteria for Selecting Instruments

For each project, the critical parameters must be identified by the designer that will require instrumentation to determine. The appropriate instruments should then be selected to measure them based on the required range, resolution, and precision of measurements. The ground conditions are another consideration in the choice of instruments. Use the following to help select instruments:

- **Landslides:** Relatively fast-moving landslides may require a larger-diameter inclinometer pipe or TDR cable to determine the zone of slide movement, or Vibrating Wire piezometers may be selected to measure groundwater in low permeability soils where a standpipe would require a large volume of water to flow into it before even small changes in pore-water pressure can be detected.
- **Temperature and humidity:** Temperature and humidity also affect the choice of instruments. Certain instruments may be difficult to use in freezing conditions while warm and humid environments may affect the reliability of electronic instruments unless particular care is taken to isolate their environment.
- **Number of parameters:** The number of parameters to measure is also important for instrument selection since soil and rock masses typically have more than one property that dictates their behavior. Some parameters correlate with one another, and instruments that obtain complementary measurements provide an efficiency gain. In areas with complex problems, several parameters can be measured, and a number of correlations can be found from instrumentation data leading to a better understanding of the site conditions. Strain gages and load cells on a retaining wall and inclinometers behind it are examples where complementary data can be obtained. When relationships

can be developed with the data, further data can be obtained even when one set of instruments fail.

- **Instrument performance and reliability:** Instrument performance and reliability are also important considerations. The cost of an instrument generally increases with higher resolution, accuracy, and precision in the instrument. In addition, the range of measurements obtained can be reduced by higher-functioning instruments, so the geotechnical designer should have a clear understanding of the scale and level of measurements to be taken.
- **Resolution:** An example is the placement of a vibrating wire transducer in a borehole to measure an unknown piezometric surface. The instrument selected would have a wide range of testing, but a lower resolution of values that could be read. Where the piezometric surface is known within a narrower range and small changes are of significance to the design, an instrument capable of reading a smaller range of values but at a higher resolution within the known range.
- **Quality of the instrument:** There are some instances where the use of lower-quality instruments is warranted, but in general, choosing a lower-quality instrument to save on initial costs is a false economy. The difference in cost between a high-quality instrument and a lower-quality instrument is low with respect to the overall cost of installing and monitoring an instrument.
- **Cost:** The cost of drilling a hole and the labor of installing the instrument is usually an order of magnitude higher than the cost of the instrument. The less easily quantifiable loss of data from a failed instrument in terms of monetary cost should also be considered. It is expensive and often impossible to replace failed instruments. Furthermore, essential baseline data is also lost that cannot be replaced.

### 4.7.3.1 Automatic Data Acquisition Systems (ADAS)

Automatic Data Acquisition Systems (ADAS) can provide significant advantages to a geotechnical instrumentation program. They can provide numerous readings at set and reliable intervals, and they can store and transmit data from remote or difficult access locations. ADAS are necessary for real-time instrument monitoring and relay. They are beneficial at sites where many sensors are present that would require copious staff time to read manually or for large-scale proof tests with many concurrently read instruments to be monitored throughout the test.

Automatic Data Acquisition Systems come in many forms ranging from the very simple, user-friendly devices to systems requiring significant programming and electronics to install and run. Project requirements usually dictate what system is selected, but the simplest, most inexpensive, and easiest to connect to the chosen instruments are best. Follow these guidelines:

- Simple data loggers connected to individual instruments that are retrieved and downloaded periodically are sufficient for most projects.
- Large, complex problems may require a more integrated and automated system that can be programmed to change monitoring routines in response to site or environmental changes.

- Most instrumentation companies also have companion data loggers to go with their products while several independent companies also manufacture easy-to-use data loggers. Other companies produce more complex systems that can read multiple installations of different types of instruments as well as store and transmit data.
- In addition to the data collection devices, these firms also produce software for processing and displaying the data. The software is another consideration if export to other systems is desired. Compatibility between programs can create problems and errors in the end product of an instrumentation project.

### 4.7.3.2 Instrument Use and Installation

Instruments have been developed to monitor many specific geologic conditions and engineering parameters. In many cases, a single instrument can be used or adapted for use on other applications. For this, the manufacturer and other professionals should be consulted to assure that the results obtained are valid, or, they may have insights and case histories that are of use for the situation. The manufacturer's literature, installation procedures, and other guidance documents should be followed for proper installation of their products as procedures can vary for different manufacturers same instrument products. Detailed discussions of instrument installation and initialization procedures, function, and operation can be found in manufacturer's documents such as [Slope Indicator Company \(SINCO\) Applications Guide](#) or in published literature such as Dunnycliff (1988).

### 4.7.3.3 Inclinometers

Inclinometers are used on transportation projects mainly to detect and monitor lateral earth movements in landslides and embankments. They are also used to monitor deflections in laterally loaded piles and retaining walls. Horizontally installed inclinometers can also be used to monitor settlement. Inclinometer systems are composed of:

- grooved casing installed in a borehole, embedded in a fill or concrete, or attached to structures,
- probe and cable for taking measurements at set intervals in the casing, and
- a digital readout unit and/or data storage device.

The installed casing is for single installation use, and the probe, cable and data storage unit are used for almost all installations.

**Note:**

*It is important to use the same probe for each reading in any particular installation since each probe must be independently calibrated.*

Inclinometers are manually read by a trained technician on a set schedule or in response to environmental changes such as increased rainfall in the area or observation of surficial signs of slope movement. In-place inclinometers spanning known or highly suspected zones of movement can be installed for continuous, automatic monitoring. These usually remain in the hole permanently if significant slope movement occurs.

- Incliner casing installation is essential to successful performance of the instrument. Shortcuts taken during installation will frequently result in poor performance of the instrument or render it useless.
- Inclinerometers should be installed according to the procedures described in the Durham Geo Applications guide with the exception of the grout valve.
- Borings should be initially drilled or later reamed to a sufficient diameter that will accommodate the inclinometer casing and an attached tremie tube.
- The tremie tube should be attached to the inclinometer casing approximately 6 inches above the bottom and along the casing at a close enough interval to prevent it from being tangled or constricted in the borehole.
- One of the four grooves in the inclinometer casing should be aligned to the direction of slide movement as the casing is assembled and lowered into the hole to prevent spiraling.
- If the borehole walls are unstable, the drill casing may need to remain in the borehole, and withdrawn as the grout level rises. Generally, the grout should be maintained at a visible level in the casing as the drill string is withdrawn.

Initial readings should be taken as soon as the grout has sufficiently set up. This is usually 3 to 5 days after grouting. During installation, some grout is naturally lost to fractures and voids in the formation. This may occur to the extent that additional grouting is required. Usually, this only entails topping off the hole with a small batch of grout to stabilize the uppermost portion of the casing. In more severe cases, the grout pump may be reconnected to the tremie tube to re-grout the remaining voids.

### **4.7.3.4 Piezometers**

Piezometers used to measure pore-water pressure and groundwater levels can range from simple standpipes to complex electronic devices or pneumatic systems. Piezometers are typically installed in selected layers to measure the piezometric pressures in that layer. The layout and target depths of piezometer installation are determined by actual site conditions and project requirements.

**Note:**

All piezometers must be installed according to [Water Resources Department](#) regulations defined by [Oregon Administrative Rules Chapter 640 Division 240](#) and [Oregon Revised Statutes](#) 537.747 and 537.880 through 537.895. Specifications for properly operating instruments are usually more stringent than these rules apart from the requirements for abandonment.

The various types of piezometers are generally used for different applications as described below.

- Standpipe piezometers are general-purpose instrument for monitoring piezometric water levels and are best suited for granular materials. Standpipe piezometers require a water level indicator to obtain readings.



- Vibrating Wire piezometers utilize a pressure transducer to convert water pressure to a frequency signal that is read by an electronic device. Vibrating Wire piezometers can be automated by electronic systems.
- Pneumatic piezometers are typically used to measure pore water pressure in saturated conditions. Both Pneumatic and vibrating wire piezometers are used for all soil types and are better suited to fine-grained soils than the standpipe variety due to the response time and volume of water needed to record changes in water level in that type.

Piezometers should be placed at the desired sensing zone in a porous medium and sealed with the appropriate materials above and below this zone to assure measurement of the piezometric pressure in the desired location. Porous mediums or filter packs should be composed of pre-screened commercial-grade silica sand. All piezometers should be installed and initialized according to their manufacturer's specifications.

### 4.7.3.5 Other Instruments

A vast array of geotechnical instruments is available for most applications. Strain gauges, extensometers, and load cells of all types and configurations for structural as well as geotechnical applications are obtainable from numerous vendors. Most vendors have prescribed applications as well as installation and monitoring procedures that should be followed when using their products on transportation projects. Professional knowledge, experience, and judgment must be applied to the use of all instruments to assure appropriate use of these instruments and the adequacy of data obtained.

## 4.8 Environmental Protection during Exploration

Compliance with all State, Federal, and Local ordinances, laws and regulations concerning environmental protection at all work locations is **mandatory** for any activity that may disturb the ground surface or vegetation. All environmental permits, clearances, or any other documentation needed for compliance with the pertinent environmental regulations must be ready prior to mobilization of exploration equipment.

The [ODOT Programmatic Biological Opinion for Drilling, Surveying, and Hydraulic Engineering Activities](#) may be applicable for some sites. This document can be referenced on the ODOT Geo-Environmental web page.

#### Note:

Every precaution necessary to minimize environmental impacts during site investigation must be taken, and every effort made to restore the site to its original condition. All drilling fluids and cuttings must be disposed of safely and legally. In no circumstance should sediment-laden water or other pollutants be allowed to enter streams or other bodies of water. In the event where there is a potential for pollutants to contaminate such, all operations will be suspended until the situation can be rectified. Violation of Federal, State, and Local environmental protection laws can result in personal penalties, including arrest and incarceration.

## 4.8.1 Protection of Fish, Wildlife, and Vegetation

Compliance with the Laws of the [Oregon Department of Fish and Wildlife](#), [North Oceanic and Atmospheric Administration](#), [US Fish & Wildlife Services](#), and the rules and practices developed through the [Oregon Plan for Salmon and Watersheds](#) is also **mandatory**. All subsurface investigation activities shall be conducted to avoid any hazard to the safety and propagation of fish and shellfish in the waters of the State.

Unless specifically authorized by the State and by permit, the Contractor shall not:

- Use water jetting
- Release petroleum or other chemicals into the water, or where they may eventually enter the water
- Disturb spawning beds or other wildlife habitat
- Obstruct streams
- Cause silting or sedimentation of water
- Use chemically treated timbers or platforms
- Impede fish passage

The permitted work area boundaries will be defined by the permit for the project from the regulatory agencies.

## 4.8.2 Forestry Protection

All necessary permits must be obtained prior to exploration in accordance with [ORS 477.625](#) and [Senate Bill 20](#), and comply with the laws of any authority having jurisdiction for protection of forests. At certain times of the year, the exploration activities will be subject to IFPL constraints, and operational schedules must be adjusted accordingly. Fire-suppression equipment may be required on site as well as a designated fire watch.

## 4.8.3 Wetland Protection

All operations shall comply with the [Clean Water Act, Section 404](#); [Ehime Maru EA APPENDIX C](#); [Oregon Administrative Rules 196.800](#); [Oregon Removal and Filling in Scenic Waterways law \(ORS 390.805 - 390.925\)](#), and other applicable Laws governing preservation of wetland resources.

**Note:**

*The terms “wetland,” or “wetlands” are defined as “Areas that are inundated or saturated by surface or groundwater at a frequency and duration sufficient to support, and that under normal circumstance do support, vegetation typically adapted for life in saturated Soil conditions. Wetlands generally include swamps, marshes, bogs, and similar areas.” Wetlands also include all other jurisdictional waters of the U.S. and/or the State.*

If wetlands are known to be on the project site, they should be delineated by the region’s wetland specialist or their contractor to prevent accidental entry by the exploration operation.

Wetlands to be temporarily impacted should also be identified at this time. Wetlands to be protected will be considered as “no work zones.”

Subsurface exploration operations must also comply with Clean Water Act Section 404 permits issued by the U.S. Army Corps of Engineers, and Fill/Removal permits issued by DSL. These permits allow specified quantities of fill and excavation, including soil and rock samples within specifically identified areas of wetlands.

### **4.8.4 Cultural Resources Protection**

The exploration crew is also required to comply with all Laws governing preservation of cultural resources. Cultural resources may include, but are not limited to, dwellings, bridges, trails, fossils, and artifacts. Known locations of cultural resources will be considered as “no work zones.” No exploration activity shall commence without written clearance from the ODOT Cultural Resources Coordinator for the specific Region the work is to be conducted in.

If cultural resources are encountered in the project area, and their disposition is not addressed in the contract, the exploration crew shall:

- Immediately cease operations or move to another area of the project site
- Protect the cultural resource from disturbance or damage
- Notify the region’s cultural resource specialist

The region’s cultural resource specialist will:

- Arrange for immediate investigation
- Arrange for disposition of the cultural resources
- Notify the exploration crew when to begin or resume operations in the affected area

## 4.9 References

- AASHTO, 2007, *LRFD Bridge Design Specifications*, American Association of State Transportation and Highway Officials, 17th Edition (with current Interims), Washington, D.C., USA.
- American Association of State Highway and Transportation Officials, Inc., 1988, *Manual on Subsurface Investigations*.
- C.H. Dowding, Ed., *Site Characterization & Exploration*, ASCE Specialty Workshop Proceedings, Northwestern University, 1978.
- Dunnicliff, John 1988. *Geotechnical Instrumentation for Monitoring Field Performance*, John Wiley & Sons, New York.
- Oregon Department of Transportation, *Hydraulics Manual*, Geo-Environmental Section, 2005.
- Oregon Department of Transportation, *Bridge Design Manual*, Bridge Engineering Section, most current version.
- [U.S. Department of Transportation, Federal Highway Administration Evaluation of Soil and Rock Properties, Geotechnical Engineering Circular No. 5, FHWA-IF-02-034, April, 2002.](#)
- U.S. Department of Transportation, [https://www.fhwa.dot.gov/engineering/geotech/library\\_sub.cfm?keyword=017](https://www.fhwa.dot.gov/engineering/geotech/library_sub.cfm?keyword=017), November, 1997.
- U.S. Department of Transportation, Federal Highway Administration *Subsurface Investigations - Geotechnical Site Characterization Reference Manual*, Publication No. FHWA NHI-01-031, May, 2002.
- <https://pubs.usgs.gov/circ/1325/pdf/Sections/Section3.pdf>, Pages 129-177.
- [https://www.publications.usace.army.mil/Portals/76/Publications/EngineerManuals/EM\\_1110-1-1804.pdf](https://www.publications.usace.army.mil/Portals/76/Publications/EngineerManuals/EM_1110-1-1804.pdf) U.S. Department of the Interior, Bureau of Reclamation, 1994, *Engineering Geology Field Manual*.
- References are made to various ASTM standards. The ASTM International standards located at <https://www.astm.org/> (the “ASTM Site”).

# Appendix 4-A Permit of Entry Form



*Oregon Department of Transportation*

**RIGHT OF ENTRY for EXPLORATION**

**REGION 3 GEOLOGY**

Phone: (541) 957-3602 FAX: (541) 957-3604

3500 NW Stewart Parkway

Roseburg, OR 97470

(1) (We) \_\_\_\_\_ and \_\_\_\_\_ hereinafter referred to as "grantor", do hereby grant to the STATE OF OREGON, by and through the Oregon Department of Transportation, and its officers, agents, and employees, the right and license to go upon the following described real property to drill or to gain access to highway Right-of -Way for exploration core drilling at:

Township 37 South, Range 2 West, Section 28  
77 Hanley Road  
Central Point, Oregon 97502

Property Description:

D-89-16328  
37-2W-28 TL 800

IT IS UNDERSTOOD AND AGREED: That this right and license shall be valid until all exploration is completed unless revoked by grantor before completion. It is further understood that the Oregon Department of Transportation shall, to the extent permitted by Oregon law, be responsible for any unnecessary damage done, in connection with said exploration, this will include any crops or other improvements on said property.

Grantor hereby represents and warrants that he/she is the owner of said property or otherwise has the right to grant this permit of entry.

Date \_\_\_\_\_ Day \_\_\_\_\_, 2003

Permission Acquired by: \_\_\_\_\_

Signature: \_\_\_\_\_

Title: Project Geologist

Owner(s)

Signature(s): \_\_\_\_\_

# Appendix 4-B Utility Notification Worksheet



Memo to File

*UTILITY LOCATE DATA SHEET*

Region Geology Unit

*Oregon Department of Transportation*

Project Name:  
 Highway and Mile Point:  
 Utility Locate Called By:  
 Locators Called (When):

<b>Required Information</b>	
Caller ID #:	
Type of Work:	
County/City	
Highway:	
Mile Point:	
Township/Range/ Quarter Section:	
Distance from Nearest Cross Street:	
Overhead Lines:	
Special Markings:	
<b>Date to Be Located:</b>	
<b>Ticket#:</b>	
<b>Name of Person Called:</b>	
<b>Utilities Notified:</b>	

<b>Utilities Field Marked:</b>	
Gas	
Electric	
Sewer	
Water	
Telephone	
Cable Television	
Irrigation	
Signals/Illumination	
Other	

# Chapter 5 - Soil and Rock Classification and Logging



## Chapter Contents

<b>Chapter 5 - Soil and Rock Classification and Logging.....</b>	<b>5-1</b>
5.1 Introduction .....	5-4
5.1.1 Purpose .....	5-4
5.1.2 Roles And Responsibilities .....	5-4
5.1.3 Points Of Contact .....	5-4
5.1.4 Chapter Revision Process.....	5-4
5.2 Soil And Rock Logging Process .....	5-4
5.3 Classification Format.....	5-5
5.3.1 Decomposed Rock Vs Soil.....	5-6
5.4 Field Classification Of Soil.....	5-6
5.4.1 Soil Name .....	5-7
5.4.2 USCS Designation .....	5-14
5.4.3 Color.....	5-14
5.4.4 Plasticity .....	5-17
5.4.5 Moisture.....	5-17
5.4.6 Consistency/Relative Density Of Soils .....	5-18
5.4.7 Texture .....	5-20
5.4.8 Cementation.....	5-22
5.4.9 Structure .....	5-22
5.4.10 Fill Materials .....	5-23

5.4.11 Other Constituents/Characteristics.....	5-23
5.4.12 Origin.....	5-24
5.5 Field Classification Of Rock.....	5-24
5.5.1 Rock Name.....	5-25
5.5.2 Color.....	5-28
5.5.3 Degree Of Weathering.....	5-29
5.5.4 Relative Strength Of Rock.....	5-30
5.5.5 Structure.....	5-31
5.5.6 Core Recovery And Rock Quality Designation (RQD).....	5-38
5.5.7 Other Rock Characteristics.....	5-38
5.5.8 Formation Name.....	5-39
5.6 Field Exploration Logs.....	5-40
5.6.1 Sample Logging.....	5-40
5.7 Check Classification Of Soil And Rock.....	5-46
5.7.1 Check Classification Of Soil.....	5-47
5.7.2 Check Classification Of Rock.....	5-48
5.8 Final Exploration Logs.....	5-48
5.9 References.....	5-50

## List of Tables

Table 5-1 Descriptive Sequence for Soil and Rock.....	5-5
Table 5-2 Soil Constituents - Definitions.....	5-7
Table 5-3 Silt and Clay Characteristics.....	5-8
Table 5-4 Examples of Fine-Grained Soil Field Identification.....	5-9
Table 5-5 Fine-Grained Soil Sub classification.....	5-10
Table 5-6 Coarse-Grained Soil Sub classification.....	5-11
Table 5-7 Organic Material Sub classification.....	5-14
Table 5-8 Field Estimated Degree of Plasticity.....	5-17
Table 5-9 Field Moisture Designations.....	5-17
Table 5-10 Consistency of Cohesive Soils.....	5-18
Table 5-11 Relative Density for Granular (Cohesionless) Soils.....	5-19
Table 5-12 Grain size terms and definitions.....	5-20
Table 5-13 Gradation definitions.....	5-21
Table 5-14 Criteria for Describing Cementation.....	5-22
Table 5-15 Criteria for Describing Structure.....	5-22
Table 5-16 Common Igneous Rocks.....	5-25
Table 5-17 Igneous Rock Textures.....	5-26
Table 5-18 Pyroclastic Rocks.....	5-26
Table 5-19 Degree of Vesicularity.....	5-27
Table 5-20 Common Sedimentary Rocks.....	5-27
Table 5-21 Common Metamorphic Rocks.....	5-28



Table 5-22 Scale of Relative Rock Weathering .....	5-29
Table 5-23 Scale of Relative Rock Strength.....	5-30
Table 5-24 Stratification Terms.....	5-31
Table 5-25 Joint and Bedding Spacing Terms .....	5-32
Table 5-26 Degree of Continuity .....	5-35
Table 5-27 GSI for blocky rock masses on the basis of interlocking and joint surface conditions 5-36	
Table 5-28 GSI for heterogeneous rock masses such as flysch.....	5-37
Table 5-29 General check classification workflow for soil. ....	5-47
Table 5-30 General check classification workflow for rock.....	5-48

**List of Figures**

Figure 5-1 Plasticity Chart .....	5-8
Figure 5-2 Visual Estimation of Volume-Based Distributions.....	5-13
Figure 5-3 USCS Soil Classification Summary .....	5-16
Figure 5-4 Particle Shape for Coarse-Grained Soil Particles .....	5-21
Figure 5-5 Particle Shape for Coarse-Grained Soil Particles .....	5-22
Figure 5-6 Orientation Measurements of Planar and Linear Features .....	5-33
Figure 5-7 Standard log form-front .....	5-43
Figure 5-8 Standard log form-back.....	5-44

## **5.1 Introduction**

### **5.1.1 Purpose**

This Chapter provides practices and procedures used by the Oregon Department of Transportation for the classification of soil and rock. Updating this chapter is a continuing process and revisions are issued as required to enhance content clarity and reflect changes in the regulatory landscape. Technical bulletins may be issued between official chapter updates that address content clarity or errors, and changes in regulations. Future chapter updates would supersede outstanding technical bulletins. Users should continually consult the Section / Unit website to ensure the most current guidance is being used. This is not a legal document.

Detailed descriptions and classifications of soil and rock are an essential part of the geologic interpretation process and the geotechnical information developed to support design and construction. This manual contains standardized procedures and guidelines for describing and evaluating soils and rock materials and for preparing exploration logs.

The Unified Soil Classification System (USCS) provides a conventional system for categorizing soils by gradation and plasticity characteristics. However, it alone does not provide adequate descriptive terminology for identifying soils. The enclosed descriptive terminology used by ODOT is not intended to replace the USCS, but to expand it in order to make the classification more precise and better understood.

Various rock description systems exist, however, no one system is universally used. This manual contains a composite procedure that incorporates significant descriptive terminology relevant to geotechnical design and construction.

### **5.1.2 Roles And Responsibilities**

Future updates of this section will outline the key roles and define the responsibilities of personnel involved with Engineering Geologic Investigations.

### **5.1.3 Points Of Contact**

This section identifies the individuals who may assist the Chapters user. If a help desk facility or telephone assistance organization is established, it will be described in this section.

### **5.1.4 Chapter Revision Process**

Chapter revisions take place biannually. Submit requested changes to ODOTGeoAdminWorkOrders

## **5.2 Soil And Rock Logging Process**

The process used by ODOT to classify and log soils and rock encountered during an exploration program is broken into three steps, field classification, office classification, and preparation of final exploration logs.

Planning and execution of the exploration program is described in [Chapters 2](#) and [3](#) of the ODOT GDM. Consistent with that planning, the field geologist should be very familiar with the exploration plan as well as possess a general knowledge of the geologic conditions present in the project vicinity.

Final exploration logs are one of the products of a site characterization for project design. They represent the culmination of a lengthy process that starts with the siting of exploration points and ends with an evaluation of materials in context to the engineering geologic characteristics of the project area. Final log production is an iterative process that draws upon increasing data as the work proceeds from field collection and field testing through office evaluation, laboratory analysis, determination of engineering and geologic properties, and comparison of the individual explorations with one another to derive engineering geologic units. In general ODOT practice, the final logs are comprised of a description of the engineering geologic units encountered with or without the individual sample descriptions and classifications.

The process of final log production takes place in three general phases. Field logging includes the collection and description of samples at the exploration site. Office evaluation, check classification, and laboratory testing is the second phase. The final phase is the incorporation of laboratory testing and correction of sample classification and description based on these results, and the subsequent modification of the unit descriptions. The unit descriptions may be further modified during creation of the subsurface model.

### **5.3 Classification Format**

The description and classification of soils and rock includes consideration of the physical characteristics and engineering properties of the material. Always describe the soil/rock as completely as possible. The soil and rock descriptions on boring logs should be based on field observations with further modification or confirmation from office and laboratory testing. Unit/Formation names and material origin should be based on literature research. The general descriptive sequence for soil and rock materials is provided in Table 5-1.

**Table 5-1 Descriptive Sequence for Soil and Rock**

<b>SOIL</b>	<b>ROCK</b>
Soil Name	Rock Name
USCS Designation	Color
<b>Color</b>	Degree of Weathering
Plasticity	Relative Strength
Moisture	Structure (joints, stratification, faults attitude, separation, filling, continuity, voids)
Consistency/Relative Density	Geologic Strength Index (GSI)

SOIL	ROCK
Texture	Core Recovery and RQD
Cementation	Other Characteristics as applicable (mineralization, slaking, field unit weight, discontinuity surface conditions, voids)
Structure	Unit/Formation
Fill Materials	
Other Constituents/Characteristics as applicable (unit weight, sensitivity, quality of coarse-grained constituents)	
<b>Origin/Unit/Formation</b>	

### 5.3.1 Decomposed Rock Vs Soil

An important facet of classification is the determination of what constitutes rock, as opposed to extremely weathered, partially cemented, or altered material which approaches soil in its character and engineering characteristics.

Material that may retain identifiable rock texture, is friable, and can be reduced to gravel size or smaller by normal hand pressure should be classified as soil. The soil classification would be preceded by the parent rock name. The following format is suggested:

**Decomposed** *rock-type*, **remolds to** *complete soil description*

The Origin/Unit/Formation may be noted as **Regolith or Saprolite** followed by the rock unit/formation, if known (Regolith/Boring Lava).

### 5.4 Field Classification Of Soil

This section presents the recommended procedures for field classification of soil. Preliminary descriptions contained on field exploration logs should be broadly consistent with ASTM D2488, Standard Practice for Description and Identification of Soils (Visual-Manual Procedure). The visual-manual method employs visual observations and simple manual tests (index tests) to estimate the size and distribution of the coarse-grained soil fractions and to indicate the plasticity characteristics of fine-grained fractions. These index tests should be performed on all samples collected.

The definitions for various soil constituents are presented in Table 5-2. For purposes of classification in this system, boulders larger than 5 feet in diameter are given the term “block” to distinguish their greater size.

**Table 5-2 Soil Constituents - Definitions**

<b>CONSTITUENT</b>	<b>DEFINITIONS</b>
Blocks	Particles of rock larger than 5-feet in diameter
Boulders	Particles of rock that will not pass a 12-inch square opening.
Cobbles	Particles of rock that will pass a 12-inch square opening and be retained on a 3-inch square opening.
Gravel	Particles of rock that will pass a 3-inch square opening and be retained on a # 4 sieve.
Sand	Particles of rock that will pass a # 4 sieve and be retained on a # 200 sieve.
Silt	Soil passing a # 200 sieve that is nonplastic or very slightly plastic and that exhibits little or no strength when air dry.
Clay	Soil passing a # 200 sieve that can be made to exhibit plasticity (putty-like properties) within a range of water contents, and that exhibits considerable strength when air dry.
Organic Soil	A soil with sufficient organic content to influence the soil properties
Peat	A soil composed primarily of vegetable matter in various stages of decomposition usually with an organic odor, or dark brown to black color, a spongy consistency, and a texture ranging from fibrous to amorphous.
Muck	A soil composed primarily of fully decomposed vegetable matter usually with an organic odor, or dark brown to black color, and a slick, oily texture.

### **5.4.1 Soil Name**

The first step in describing a soil is to determine whether it is predominately fine-grained, coarse-grained, or organic. A mixed-grain soil (containing both fine-and coarse-grained constituents) is categorized by determining its predominant engineering behavior and by visually estimating the percentages of fine- and coarse-grained constituents. There are three techniques available for estimating the percentage of gravel, sand, and fines in a sample: the jar method, the visual method, and the wash test, as described in Appendix X4 of ASTM D2488. Soils containing more than 50 percent visible particles are coarse-grained soils. After the sample is determined to be predominantly fine- or coarse-grained, the next step is to determine the primary, secondary, and additional constituents. For rapid and easy identification, the primary constituent should be written in upper case letters, i.e., GRAVEL, SAND, SILT, CLAY. The procedures for describing and classifying fine- and coarse-grained soils are described in the following subsections.

### 5.4.1.1 Fine-Grained Soils

Fine-grained soils are described by their engineering behavior considering such physical characteristics as dilatancy, dry strength, toughness, dispersion, and plasticity, as summarized on Table5-4. Examples of soil descriptions based on field index tests are shown on Table5-5. Table 5-6 summarizes the sub classification order for fine-grained soils. For instance, a soil which contains 80% fine-grained constituents (medium dry strength, slow dilatancy, medium toughness, low plasticity) and 20 % sand would be classified as “Clayey SILT with some sand.” It is possible to have two secondary constituents. For instance, a soil with 40% sand and 60% fine-grained constituents (medium plasticity, no dilatancy, medium toughness, and medium dry strength) would be described as “sandy, silty CLAY.”

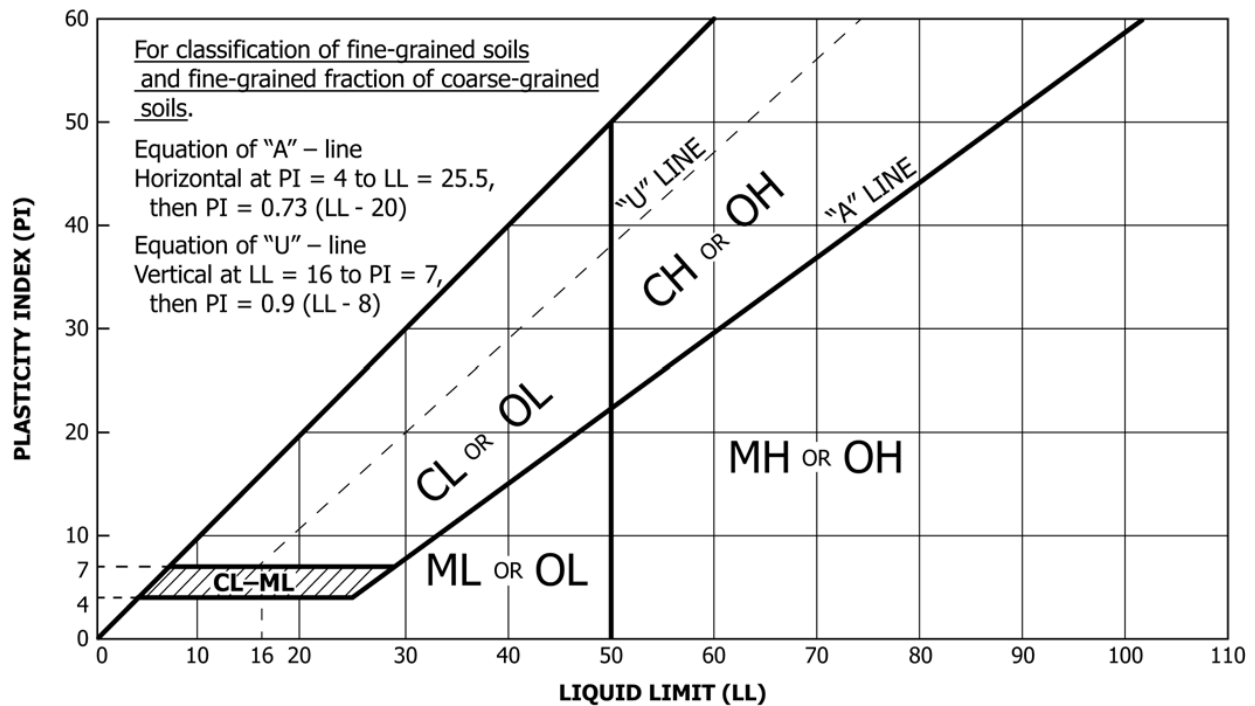

Figure 5-1 Plasticity Chart

Table 5-3 Silt and Clay Characteristics

CHARACTERISTIC	SILTS	CLAYS
<b>DILATANCY</b> Reaction to shaking, movement of water in voids. <ul style="list-style-type: none"> <li>• None</li> <li>• Slow</li> </ul>	Rapid Reaction. Water appears on the surface to give a livery appearance when shaken. Squeezing	Sluggish to no reaction. Surface of the sample remain lustrous. Little to no water appears when hand is shaken. Sample remains lustrous during squeezing.

<b>CHARACTERISTIC</b>	<b>SILTS</b>	<b>CLAYS</b>
<ul style="list-style-type: none"> <li>• Rapid</li> </ul>	the soil causes water to disappear rapidly.	
<b>DRY STRENGTH</b> Cohesiveness in dry state. <ul style="list-style-type: none"> <li>• None</li> <li>• Low</li> <li>• Medium</li> <li>• High</li> <li>• Very High</li> </ul>	None to low. Even oven-dry strength is low. Powder easily rubs off surface of the sample. Little or no cohesive strength, will crumble and slake readily.	High to very high. Exceptionally high if oven-dry. Powder will not rub off the surface. Crumbles with difficulty. Slakes slowly.
<b>TOUGHNESS</b> Plasticity in moist state. <ul style="list-style-type: none"> <li>• Low</li> <li>• Medium</li> <li>• High</li> </ul>	Plastic thread has little strength. Dries quickly. Crumbles easily as it dries below plastic range. Seldom can be rolled to 1/8" thread without cracking.	Plastic thread has high strength. Dries slowly. Usually stiff and tough as it dries below plastic range. Can easily be rolled to 1/8" thread without cracking.
<b>DISPERSION</b> Settlement in Water	Settles out of suspension in 15 to 60 minutes (sands settle in 30 to 60 seconds).	Settles in several hours or days, unless it flocculates (rapidly precipitates out in small clumps).
<b>VISUAL INSPECTION AND FEEL</b>	Only coarsest individual soil grains are visible to the naked eye. Feels slightly gritty when rubbed in fingers. Dries quickly and dusts off easily.	Individual grains cannot be observed by the naked eye. Feels smooth and greasy when rubbed in fingers. Dries slowly and does not dust off, must be scraped off.

**Table 5-4 Examples of Fine-Grained Soil Field Identification**

<b>Typical Name</b>	<b>Dry Strength</b>	<b>Dilatancy Reaction</b>	<b>Toughness of Plastic Thread</b>	<b>Plasticity</b>
<b>SILT</b>	none to low	rapid	low	nonplastic
<b>SILT with some clay</b>	low to medium	rapid, slow	low, medium	low
<b>clayey SILT</b>	medium	Slow	Medium	Low, medium
<b>silty CLAY</b>	medium to high	slow, none	medium, high	
<b>CLAY with some silt</b>	high	none	high	high

Typical Name	Dry Strength	Dilatancy Reaction	Toughness of Plastic Thread	Plasticity
CLAY	very high	none	high	high
Organic SILT	low	slow	low, medium	nonplastic, low
Organic CLAY	medium to very high	none	Medium, high	medium, high

**Table 5-5 Fine-Grained Soil Sub classification**

Terms	Percent (by Weight) of Total Sample	Primary Constituent
SILT, CLAY	*	PRIMARY CONSTITUENT*
Clayey, Silty w/some (silt, clay)	*	Secondary Fine-Grained Constituents Additional Fine-Grained Constituents
Sandy, Gravelly w/ some (sand, gravel)	30 – 50	Secondary Coarse-Grained Constituents Additional Coarse-Grained Constituents
w/trace (sand, gravel)	15 – 30	Additional Coarse-Grained Constituents
	5 - 15	Additional Coarse-Grained Constituents

**\* The relationship of clay and silt constituents is based on plasticity and normally determined by performing index tests. Refined classifications are based on Atterberg Limits tests and the Plasticity Chart (Figure 4.1)**

### 5.4.1.2 Coarse-Grained Soils

Coarse-grained soils are described on the basis of particle-size distribution, as shown on Table 5-7. In the absence of grain-size test results, the percent distribution of the various constituents should be visually estimated. Where no constituent exceeds 50 percent of the total sample, then the coarse-grained constituent having the largest percentage becomes the primary constituent. If the soil does not include any discernable fines, then describe soil as “clean.” Where the secondary or additional constituent is fine-grained the term “clay” or “silt” is selected based on the predominant plasticity characteristics from index tests (Tables 5-5 and 5-6). For instance, a soil with 48% sand, 42% gravel, and 10 % fine-grained constituents (non-plastic, low dry strength) would be described as Gravelly SAND with some silt.



Table 5-6 Coarse-Grained Soil Sub classification

Terms	Percent (by Weight) of Total Sample Reaction	Primary Constituent
<b>GRAVEL, SAND</b>	Predominant Constituent	PRIMARY CONSTITUENT
<b>Gravelly, sandy</b>	30 – 50	Secondary Coarse-Grained Constituents
<b>w/some (gravel, sand)</b>	15 – 30	Additional Coarse-Grained Constituents
<b>w/trace (gravel, sand)</b>	5 – 15	Additional Coarse-Grained Constituents
<b>Silty, Clayey</b>	12 – 50	Secondary Fine-Grained Constituents
<b>w/some (silt, clay)</b>	5 – 12	Additional Fine-Grained Constituents
<b>w/trace (silt, clay)</b>	< 5	
* Index tests and/or plasticity tests are performed to determine whether the term “silt” or “clay” is used.		

The standard format for soil descriptions requires the secondary constituent to be capitalized, the primary constituent to be written in all capital letters, and the additional constituents to be written without capitals. For example: Clayey SILT with some sand, ML or Sandy GRAVEL with some silt, trace clay.

Where stratified soils are encountered, each layer should be classified. The significant dimensions of the lenses/layers should be noted. For instance, a soil that is predominantly fine-grained (low dry strength, medium plasticity) with thin (1-inch) layers of clean sand would be described as “clayey SILT with 1- inch layers of clean sand.”

### **5.4.1.3 Cobbles And Boulders**

The sub classifications described above are not generally applied to cobbles and boulders. Rather, cobbles and boulders are described by their frequency within the formation.

Since cobbles and boulders are particles more than three inches in diameter, they will not generally be sampled through conventional driven or pushed samplers. However, an estimate of their distribution and frequency is a crucial element in adequately characterizing subsurface conditions encountered during field explorations.

Estimation of the volume of cobbles and/or boulders is based upon recovered intersected or observed lengths and/or drill rig behavior.

The logging of individual cobbles and boulders recovered during sampling should be logged with information consistent with logging rock samples, notably by reference to rock type, rock strength, and the encountered dimension.

For example, it is estimated that 30% by volume of the material is cobbles, describe the sample as:

SAND with Gravel and Cobbles; SW; Dark yellowish brown (10YR 4/2); Nonplastic; Wet; Medium dense; Coarse to fine rounded sand, coarse subrounded to rounded gravel, 30% by volume basalt cobbles, very strong, R5, 4-6 inches, subrounded; Not cemented; Stratified. Alluvium.

If the predominant constituent of the layer is estimated to be cobbles and/or boulders, the soil name must be “COBBLES” or “BOULDERS” or “COBBLES and BOULDERS” with the interstitial or matrix soil description following. For example, it is estimated that 60% by volume of the material is cobbles, describe the layer as:

Basalt COBBLES; 60% by volume; Very strong, R5; 8-10 inches, subrounded; with interstitial SAND with trace Gravel (SW); Dark yellowish brown (10YR 4/2); Nonplastic; Wet; Medium dense; Coarse to fine rounded sand; coarse, subrounded to rounded, gravel; uncemented; Stratified. Alluvium.

Or if there are 45% boulders in a SW matrix:

Basalt BOULDERS; 45% by volume; Very strong, R5; 18-24 inches; in a matrix of SAND with trace Gravel (SW); Dark yellowish brown (10YR 4/2); Nonplastic; Wet; Medium dense; Coarse to fine rounded sand; coarse, subrounded to rounded, gravel; Not cemented; Stratified. Alluvium.

### **Description of Cobbles and Boulders**

The description of cobbles and boulders must include, at a minimum, the following information:

- Rock Type or Rock Name
- Rock strength
- Shape
- The intersected length(s)

An intersected length is the measured or observed length of cobble or boulder during drilling. This is not necessarily the maximum size of the cobble or boulder, e.g., a 10-inch intersected length may be identified as a boulder.

#### Rock Fragments

The terms “Gravel”, “Cobble”, and “Boulder” imply an alluvial origin of those materials. Coarse-grained soils of non-alluvial origins such as talus, landslide debris, or fill materials should be described as Rock Fragments. The size of rock fragments should be described with the same terminology as their alluvial equivalent, i.e. Gravel-sized ROCK FRAGMENTS, GP. Textural description should follow the same format; i.e. “gravel to cobble-sized rock fragments”, “coarse sand to gravel-sized rock fragments”.

## **5.4.1.4 Organics**

Organics can generally be identified by their distinctive dark color and by their spongy feel. Fresh, wet organic soils usually have a distinctive odor of decomposed organic matter. This

odor can be made more noticeable by heating the wet sample. The estimated percent and type of organic material present should be included in the sample description. An estimation of percent organics is based on a percent by volume of the total sample and may be obtained through visual comparison of the sample to a standardized comparison chart, Figure 5-2. The organic material sub classification is shown on Table 5-7.

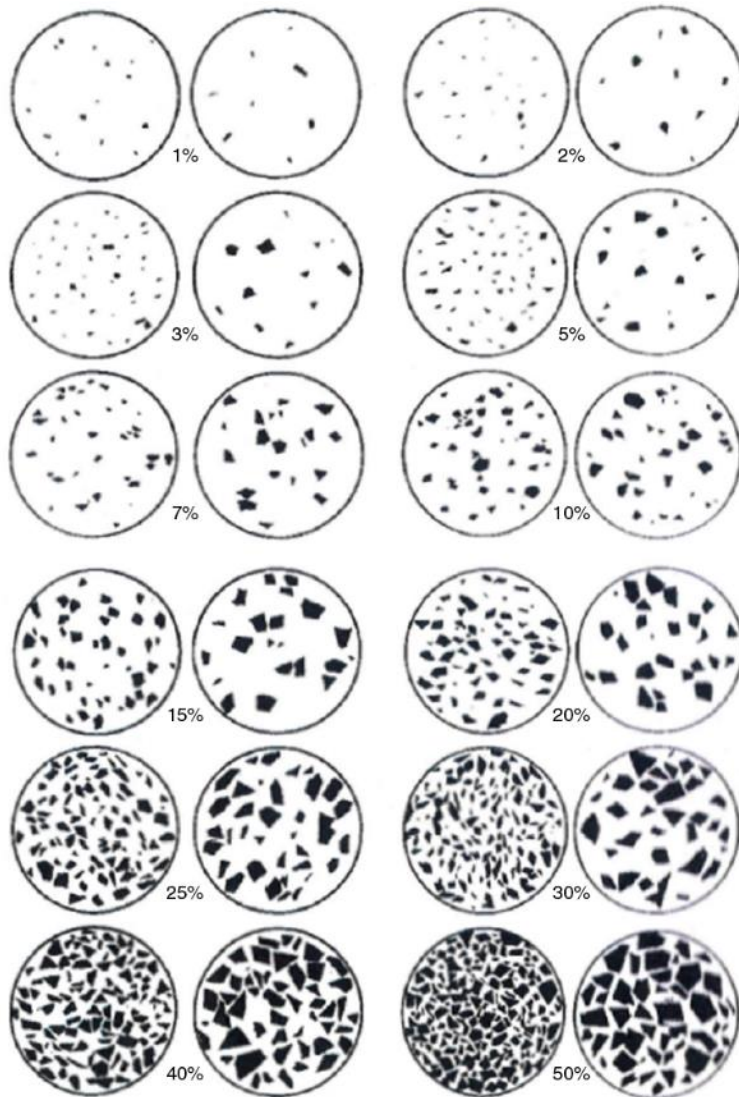

**Figure 5-2 Visual Estimation of Volume-Based Distributions**

After Rothwell (1989)

The definitions for various soil constituents are presented in Table 5-2.

Table 5-7 Organic Material Sub classification

TERM	ORGANIC PERCENT (BY VOLUME) OF TOTAL SAMPLE	
PEAT	50-100	PRIMARY CONSTITUENT
organic (SOIL NAME)	15-50	Secondary Organic Constituent
(SOIL NAME) w/ some organics	5-15	Additional Organic Constituents
(SOIL NAME) w/trace organics	<5	Additional Organic Constituents

Secondary soil constituents should be described for peats. For example, if a soil contains greater than 50% organics by volume and more than 12% silt by weight, the material would be described as a “silty PEAT.” The term “Silty PEAT” would also apply to a material having greater than 50% organics by volume and a significant percentage of silt (i.e. 80%) by weight.

The type of organic material (i.e. peat, wood fibers, carbonized wood, grass, leaves, and roots) should be identified if possible, or referred to as organics. An example would be: “silty SAND with trace clay; some carbonized wood.”

Organics may be fibrous and/or amorphous. Organic material may be very finely divided and hard to identify if a strong organic odor is not present. Consider the location when describing samples (i.e., former stream channel, flood plain). If you cannot identify organic material, but suspect its presence (due to color, odor, etc.) then indicate “organics may be present” or “organic odor.” A natural moisture content determination or liquid limit test on samples before and after oven drying may verify your observation (Atterberg limits tests are not applicable for peat).

## 5.4.2 USCS Designation

The USCS designation should be determined by following the procedures specified in ASTM D2487. The USCS designation as reported on field exploration logs will be an approximation based on the visual-manual soil description (ASTM D2488). Figure 5-3 presents a summary of the USCS, simplified for field use. The ODOT hierarchy of terms (Sandy, Silty...Some, Trace) is used to convey a vernacularly comprehensible description of soil to all users of geologic information. Since a full USCS classification requires laboratory testing it is not reasonable to use the entire USCS description on a field log. Figure 5-3 represents the level of USCS classification that can plausibly be achieved in the field.

## 5.4.3 Color

Soil color is not in itself a specific engineering property, but may be an indicator of other significant properties such as soil chemistry, ground water (e.g., mottling indicating wet/dry

cycles), alteration/weathering, or relative natural moisture content. Color may also be an aid in subsurface correlation.

Soil coloring may change quite quickly under exposure to air or through changes in moisture content or degree of oxidation. As such, the color should be field-determined from fresh soil samples at their natural moisture content. Use the Rock Color Chart (or Soil Color Chart) (Munsell Color System) to determine the color(s) of the soil. Record the color name and the alpha-numeric notation: i.e. Dark yellowish brown (10YR 4/2). Describe the “net” color, that is, for a sand with white and dark gray grains, the net color would be Medium gray (N5), not White (N9) and dark gray (N3). Generally, avoid listing more than two colors. When color variations are observed and considered significant, additional adjectives such as “mottled” or “streaked” may be used. For instance, “SAND, SW, Moderate brown (5YR 3/4) and medium gray (N5) mottled, etc.”

Where Munsell Charts are unavailable, color should be described in terms of primary colors or combinations of primary colors and modified by shades when necessary i.e. Yellow-Brown, Light Orange, Yellow-Green, etc. Do not use popular color names such as “Peach”, “Tan”, “Lemon Yellow”, or similar terms for color combinations of a specific definition. “Pink” is not a primary color.

UNIFIED SOIL CLASSIFICATION		
MAJOR DIVISIONS	GROUP SYMBOLS	TYPICAL NAMES
CLEAN COARSE GRAINED SOILS (LESS THAN 5% PASSING THE #200 SIEVE)	GRAVELS More than 50% of coarse fraction is retained on the # 4 sieve	GW Well graded GRAVEL
		GP Poorly graded GRAVEL
	SANDS More than 50% of coarse fraction passes the # 4 sieve	SW Well graded SAND
		SP Poorly graded SAND
COARSE GRAINED SOILS WITH FINES (BETWEEN 5% AND 12% PASSING THE #200 SIEVE)	GRAVELS More than 50% of coarse fraction is retained on the # 4 sieve	GW-GM or GW-GC Well graded GRAVEL with silt or well graded GRAVEL with clay
		GP-GM or GP-GC Poorly graded GRAVEL with silt or poorly graded GRAVEL with clay
	SANDS More than 50% of coarse fraction passes the # 4 sieve	SW-SM or SW-SC Well graded SAND with silt or well graded SAND with clay
		SP-SM or SP-SC Poorly graded SAND with silt or poorly graded SAND with clay
COARSE GRAINED SOILS WITH SIGNIFICANT FINES (MORE THAN 12% PASSING THE #200 SIEVE)	GRAVELS More than 50% of coarse fraction is retained on the # 4 sieve	GM or GC Silty GRAVEL or clayey GRAVEL
	SANDS More than 50% of coarse fraction passes the # 4 sieve	SM or SC Silty SAND or clayey SAND
FINE GRAINED SOILS More than 50% of the material passes the #200 sieve	SILT AND CLAY Liquid Limit less than 50	ML Inorganic silt, rock flour, nonplastic to low plasticity
		CL Inorganic clay, low to medium plasticity. Lean clay
		OL Organic silt and clay, low plasticity
	SILT AND CLAY Liquid Limit greater than 50	MH Inorganic silt, medium plasticity. Elastic silt
		CH Inorganic clay, high plasticity. Fat clay
		OH Organic silt and clay, medium to high plasticity
HIGHLY ORGANIC SOILS	PT Peat and other highly organic soils	
Boundary classifications	Soil possessing characteristics of two groups are designated by combinations of group symbols. For example GW-GC, well graded gravel-sand mixture with clay binder	

Figure 5-3 USCS Soil Classification Summary

## 5.4.4 Plasticity

Plasticity is a significant indicator property for cohesive soils. Field estimates of plasticity should be based on dry strength and toughness tests (ASTM D2488). The relationships between these index tests and the plasticity are shown on Table 5-8.

Table 5-8 Field Estimated Degree of Plasticity

TERM	PLASTICITY INDEX PI %	DRY STRENGTH	FIELD TEST (APPROXIMATION)
<b>Nonplastic</b>	0-3	Very Low	Dry specimen ball falls apart easily. Cannot be rolled at any moisture content.
<b>Low Plasticity</b>	3-15	Low	Dry specimen ball easily crushed with fingers. 1/8" thread can barely be rolled within its plastic range.
<b>Medium Plasticity</b>	15-30	Medium	Difficult to crush dry specimen ball when dry. 1/8" thread is easy to roll.
<b>High Plasticity</b>	30 or More	High	Impossible to crush dry specimen ball with fingers. 1/8" thread takes considerable time to roll/knead to reach plastic limit. Can be rerolled several times without breaking after reaching plastic limit.

## 5.4.5 Moisture

A visual estimation of relative moisture content should be made during field classification (ASTMD 2488). Natural moisture contents should be determined in the laboratory for all soils containing more than 5 percent fine-grained material. The typical classifications are presented in Table 5-9.

Table 5-9 Field Moisture Designations

TERM	FIELD IDENTIFICATION
<b>Dry</b>	Absence of moisture. Dusty, dry to the touch.
<b>Damp</b>	Soil has moisture. Cohesive soils are below plastic limit (BPL) and usually moldable.
<b>Moist</b>	Grains appear darkened, but no visible water. Silt/clay will clump, sand will bulk. Soils are often at or near plastic limit.

TERM	FIELD IDENTIFICATION
Wet	Visible water on larger grain surfaces. Sand and cohesionless silt exhibit dilatancy. Cohesive silt/clay can be readily remolded. Soil leaves wetness on the hand when squeezed. Wet indicates that the soil is much wetter than the optimum moisture content and above plastic limit (APL).

## 5.4.6 Consistency/Relative Density Of Soils

An important index property of cohesive (plastic) soil is its consistency. The consistency of cohesive soil is expressed qualitatively by terms such as very soft, soft, medium stiff, stiff, hard, and very hard. Similarly, a significant index property of a cohesionless (non-plastic) soil is its relative density. Relative density terms include very loose, loose, medium dense, dense, and very dense.

### Consistency.

Consistency is an indicator of the shear strength ( $s_u$ ) of a cohesive soil. The shear strength can be estimated from manual and mechanical field tests (i.e., Standard Penetration Test [SPT], torvane, and pocket penetrometer), or determined by laboratory testing (i.e., unconfined compressive or triaxial shear strength). Normally, the above tests are performed on undisturbed materials. Pocket penetrometer tests on cohesive samples from SPT tests will generally underestimate the undisturbed shear strength. These results, although conservative, may still be useful in preliminary design. Correlation of consistency terms with various parameters determined from both field and laboratory tests are summarized in Table 5-10.

Table 5-10 Consistency of Cohesive Soils

CONSISTENCY	SPT N VALUE BLOWS/FOOT	APPROXIMATE UNDRAINED SHEAR STRENGTH $S_u$ TSF	FIELD APPROXIMATION
Very Soft	<2	<0.125	Squeezes between fingers when fist is closed. Easily penetrated several inches by fist.
Soft	2-4	0.125-0.25	Easily molded by fingers. Easily penetrated several inches by thumb.
Medium Stiff	4-8	0.25-0.50	Molded by strong pressure of fingers. Can be penetrated several



CONSISTENCY	SPT N VALUE BLOWS/FOOT	APPROXIMATE UNDRAINED SHEAR STRENGTH $S_u$ TSF	FIELD APPROXIMATION
			inches by thumb with moderate effort.
<b>Stiff</b>	8-15	0.50-1.0	Dented by strong pressure of fingers. Readily indented by thumb but can be penetrated only with great effort.
<b>Very Stiff</b>	15-30	1.0-2.0	Readily indented by thumb nail
<b>Hard</b>	30-60	>2	Indented with difficulty by thumb nail.
<b>Very Hard</b>	>60		

Pocket penetrometer and unconfined compression tests yield  $q_u$ . Torvane yields  $S_u$ .  $S_u = q_u/2$

**Relative Density.**

Relative density of uncemented granular or cohesionless soils is a measure of the compactness of the soil. Nonplastic SILT soils which exhibit general properties of granular soil are given a relatively density description. Relative density can be estimated from a simple manual field test, or evaluated with the Standard Penetration Test (ASTMD 1586, AASHTO T206). Relative density terms are related to SPT N-values and rudimentary field tests, as shown in Table 5-11.

**Table 5-11 Relative Density for Granular (Cohesionless) Soils**

CONSISTENCY	SPT N VALUE BLOWS/FOOT	FIELD APPROXIMATION
<b>Very Loose</b>	0-4	Easily penetrated many inches (>12) WITH ½ inch rebar, pushed by hand.
<b>Loose</b>	4-10	Easily penetrated several inches with ½" rebar pushed by hand.
<b>Medium Dense</b>	10-30	Easily to moderately penetrated with ½" rebar driven by 5 lb. hammer.
<b>Dense</b>	30-50	Penetrated 1 foot with difficulty using ½" rebar driven by 5 lb. hammer.
<b>Very Dense</b>	>50	Penetrated only a few inches with ½" rebar driven by 5 lb. hammer.

## 5.4.7 Texture

Texture refers to the actual size, shape, and gradation of the constituent grains. Table 5-12 defines the most common grain size terms. The maximum coarse-grained size recovered in soils should be noted. Figure 5-4 shows various shapes of bulky (granular) grains and their corresponding classification. The gradation definitions are presented in Table 5-13. Coarse-grained soils having less than 12 percent passing the # 200 sieve require gradation descriptions, i.e., well-graded, poorly-graded (uniform or gap-graded).

**Table 5-12 Grain size terms and definitions**

Term		Grain Size (inches or sieve #)
Blocks		> 5 feet
Boulders		>12 inches and < 5 feet
Cobbles		3 – 12 inches
Gravel	Coarse	$\frac{3}{4}$ - 3 inches
	Fine	#4 – $\frac{3}{4}$ inches
Sand	Coarse	#10 - #4
	Medium	#40 - #10
	Fine	#200 - #40

Table 5-13 Gradation definitions

Gradation Term (USCS)	Definition	Example
Well-graded (GW, SW)	The full range of grain sizes, evenly distributed	Coarse to fine grained sand Coarse to fine gravel
Poorly-graded (GP, SP)	A limited range of contiguous grain sizes	Medium to fine grained sand
Uniformly-graded (GP, SP)	Predominantly one grain size	Fine grained sand Coarse gravel
Gap-graded (GP, SP)	Gaps within the range of grain sizes present	Medium to fine grained sand with coarse gravel Fine gravel with fine grained sand

**Particle shape**

When the particle shape of coarse grained soils can be observed directly (coarse sand grains, gravel, cobbles, and boulders) the angularity of the particles should be described, consistent with Figure 5-4.

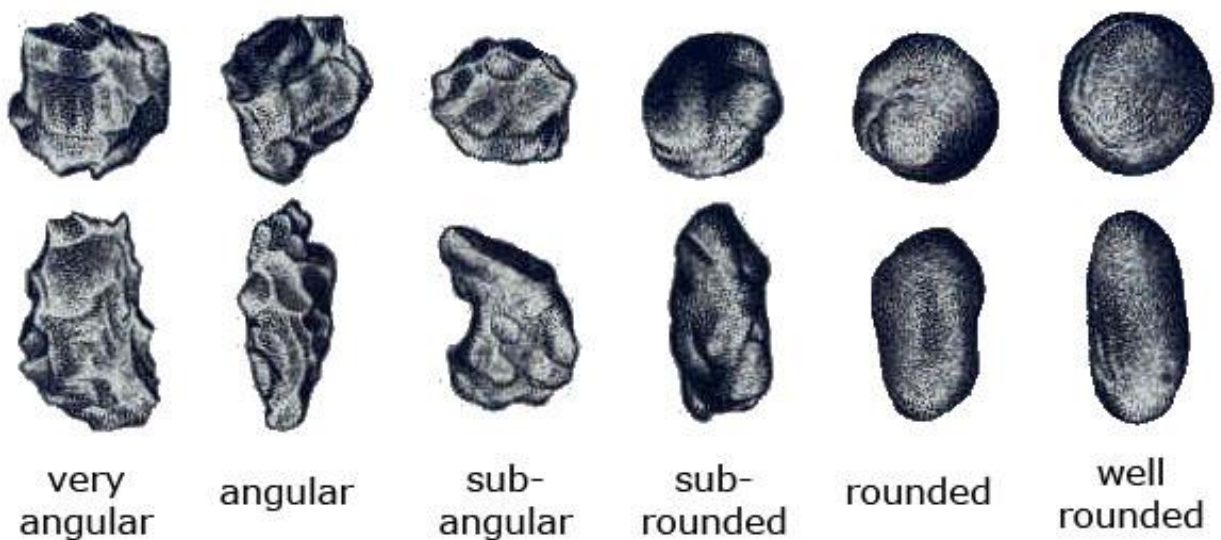

Figure 5-4 Particle Shape for Coarse-Grained Soil Particles

After Powers, 1953



Figure 5-5 Particle Shape for Coarse-Grained Soil Particles

After Field Studies Council, 2016.

### 5.4.8 Cementation

Cementation is the bonding of grains by secondary minerals (e.g., calcite) or degradation products (e.g., clay). Whenever possible, the cementing material should be noted i.e. “weak iron oxide cementation, moderate calcium carbonate cementation, etc.”. The presence of calcium carbonate cementation can be detected by its reaction to hydrochloric acid. The relative degree of cementation of undisturbed soil samples is defined in Table 5-14.

Table 5-14 Criteria for Describing Cementation

TERM	CRITERIA
Uncemented	No discernable cementation
Weak	Crumbles or breaks with handling or little finger pressure.
Moderate	Crumbles or breaks with considerable finger pressure.
Strong	Will not crumble or break with finger pressure.

### 5.4.9 Structure

Structural features include stratifications, varves, lenses, fissures, seams, slickensides, striations, blocky structure, relict rock structure, voids (root or worm holes, cavities). The thickness, frequency, and inclination of these features should be noted. Table 5-15 presents criteria for describing structure.

Table 5-15 Criteria for Describing Structure

TERM	CRITERIA
Stratified	Alternating layers of varying material or color with layers at least 6 mm thick, note thickness.

TERM	CRITERIA
Laminated	Alternating layers of varying material or color with layers less than 6 mm thick, note thickness.
Fissured	Contains shears or separations along planes of weakness.
Slickensided	Shear planes appear polished or glossy, sometimes striated.
Blocky	Cohesive soil that can be broken down into small angular lumps which resist further breakdown.
Lensed	Inclusion of small pockets of different soils, such as small lenses of clay, note thickness.
Homogeneous	Same color and appearance throughout.

### 5.4.10 Fill Materials

All soils should be examined to see if they contain foreign materials indicative of man-made fills. Nonstructural fills are often a problem in design. Man-made and other foreign fill items should be listed in each of the soil descriptions. Common man-made items include glass, brick, dimensioned lumber, concrete, metal, plastics, plaster, etc. Other items that could suggest fill include buried vegetation mats, tree limbs, stumps, etc. The soil description for a fill material should be followed by the term “(Fill)”, i.e., for a clayey silt fill with some brick fragments the description would be “clayey SILT, ML, with gravel to cobble-sized brick fragments (Fill).” The size distribution of miscellaneous items should be noted. The limits (depth range) of fill material should be determined and identified at each exploration location.

### 5.4.11 Other Constituents/Characteristics

Additional constituents and/or pertinent characteristics not included in the previous categories should be described, depending on the scope and objectives of the project. Some of these other constituents/characteristics include the following:

**Unit Weight.** The total unit weight is generally laboratory determined on undisturbed soil samples, and may sometimes be determined in-situ. The field observation of significant variations in unit weight (soils obviously heavier or lighter than otherwise encountered within the borehole or project) should be noted on the field logs.

**Quality of Coarse-Grained Constituents.** Where the soil is predominantly coarse-grained, the nature and condition of the coarse grains should be described. For instance, the parent rock type(s), hardness (soft or hard), and weathering (fresh, weathered, or decomposed).

Identification or differentiation of formations can sometimes be discerned by noting the presence of mica, gypsum, quartzite, or other components.

Other characteristics that may be observed in the field should be noted. These include oxide staining, organic, chemical or petroleum odors, and oxide or carbonate concretions.

**Note:** Indications of contamination must be noted and safety precautions must be in place before proceeding if such evidence is detected. Health and Safety Plans must include procedures for encountering unanticipated site contamination.

### **5.4.12 Origin**

The origin of the soil is generally interpreted based on a knowledge of geologic site conditions and soil description. A generic name for the soils origin may be provided at the end of the description, such as Alluvium, Colluvium, Decomposed [rock name], Fill, etc. Where known, the formation name should be included in parentheses at the end of the description.

#### DESCRIPTION

Sample descriptions will be written in the same order as they have been discussed previously: Secondary constituent, PRIMARY CONSTITUENT, secondary constituents, USCS designation; color, plasticity, moisture, consistency/relative density, texture, gradation, shape, cementation, structure, other constituents/characteristics, (Origin). A semicolon should follow the USCS designation with all descriptive terms in lower-case and separated by a comma. The Origin should be capitalized.

#### Examples:

Clayey SILT with some sand, ML; brown, low plasticity, moist, stiff, medium, subangular sand\*, uncemented, homogeneous, micaceous, (Portland Hills Silt).

Sandy GRAVEL with trace silt, GW; brown and gray, nonplastic, damp, medium dense, fine to coarse gravel, fine to coarse sand, well-rounded gravel, subangular to subrounded sand, weak iron oxide cementation, homogeneous, basalt and quartzite gravel, (Alluvium).

GRAVEL with trace sand, GP; gray, nonplastic, dry, very dense, coarse, angular gravel, coarse, angular sand\*, uncemented, homogeneous, andesite gravel, (Colluvium).

\*The recorder has the option to combine size and shape descriptions for each coarse-grained constituent, i.e. describing the size and shape of the gravel and then the size and shape of the sand.

## **5.5 Field Classification Of Rock**

Rock classification for engineering purposes consists of two basic assessments: that for intact character, such as a hand specimen or small fragment; and in-situ character, or engineering features of rock masses.

Intact Character. Classification of the intact rock, such as hand specimens or core, is in terms of its origin, mineralogical makeup, texture, and degree and nature of chemical and physical weathering or alteration.

In-Situ Character. Classification of in-place rock masses includes the nature and orientation of its constituent interlocking blocks, plates, or wedges formed by bounding discontinuities such as bedding, foliation planes, joints, shear zones, and faults.

Both assessments are essential for design. Both characteristics are the basis for rock slope design and excavation and many facets of rock anchorage and bearing capacity determinations.

### **5.5.1 Rock Name**

Rocks are classically divided into three general categories: igneous, sedimentary, and metamorphic.

Igneous rocks are classified based on mineralogy and genetic occurrence (intrusive or extrusive). Texture is the most conspicuous feature of genetic occurrence.

Sedimentary rocks are classified on the basis of grain size, mineralogy, and on the relationship between grains.

The most conspicuous features of metamorphic rocks are generally their structural features, especially foliation.

The complete name of a rock specimen or rock unit should include texture and lithologic name. The rock name should be in simple geologic terms. The rock name should be completely written in capital letters. The following tables present common rock names and their characteristics.

#### **5.5.1.1 Igneous Rocks**

**Table 5-16 Common Igneous Rocks**

<b>INTRUSIVE (COARSE- GRAINED)</b>	<b>ESSENTIAL MINERALS</b>	<b>COMON ACCESSORY MINERALS</b>	<b>EXTRUSIVE (FINE- GRAINED)</b>
<b>GRANITE</b>	Quartz Orthoclase	Plagioclase Mica Amphibole Pyroxene	<b>RHYOLITE</b>
<b>DIORITE</b>	Plagioclase	Mica Amphibole Pyroxene	<b>ANDESITE</b>
<b>GABBRO</b>	Plagioclase	Amphibole	<b>BASALT</b>

INTRUSIVE (COARSE- GRAINED)	ESSENTIAL MINERALS	COMMON ACCESSORY MINERALS	EXTRUSIVE (FINE- GRAINED)
Pyroxene			

**Table 5-17 Igneous Rock Textures**

TEXTURE	GRAIN SIZE	ROCK TYPE
<b>Pegmatitic</b>	Very large crystals, diameters measured in inches or feet. Wide range of sizes.	Intrusive
<b>Phaneritic</b>	Crystals can be seen with the naked eye.	Intrusive or Extrusive
<b>Aphanitic</b>	Crystals cannot be seen with the naked eye.	Intrusive or Extrusive
<b>Glassy</b>	No crystals present.	Extrusive
<b>Porphyritic</b>	Larger crystals in a finer-grained groundmass.	Intrusive or Extrusive

**Table 5-18 Pyroclastic Rocks**

TERM	CRITERIA
<b>Cinders</b>	Uncemented glassy and vesicular ejecta 4-32 mm size.
<b>Tuff Breccia (agglomerate)</b>	Composed of ejecta >32 mm size, in ash/tuff matrix, indurated.
<b>Lapilli Tuff</b>	Composed of ejecta 4-32 mm size, in ash tuff matrix, indurated.
<b>Tuff</b>	Cemented volcanic ash particles <4 mm size, indurated.
<b>Pumice</b>	Excessively vesiculated glassy lava.

### **5.5.1.2 Vesicularity.**

Vesicles in volcanic rocks are rounded cavities due to gas bubbles in molten lava. Cavities or openings in other rocks (e.g., intergranular space) should be described in other terms, such as porosity (e.g., porous sandstone).

The occurrence of vesicles are to be reported using the Comparison Chart (Figure 5-2) to estimate relative percent area occupied by vesicles and the designations in Table 5-21.



Table 5-19 Degree of Vesicularity

TERM	PERCENTAGE BY VOLUME OF TOTAL SAMPLE
Some Vesicles	5-25 Percent
Highly Vesicular	25-50 Percent
Scoriaceous	>50 Percent

### 5.5.1.3 Sedimentary Rocks

Table 5-20 Common Sedimentary Rocks

A. CLASTIC SEDIMENTARY ROCKS	
ROCK NAME	ORIGINAL SEDIMENT
CONGLOMERATE	Gravel, or sand and gravel.
SANDSTONE	Sand.
SILTSTONE	Silt.
CLAYSTONE	Clay.
MUDSTONE	Silt, clay, possibly with sand and/or gravel inclusions, massive.
SHALE (laminated claystone/siltstone)	Oriented, laminated, fissile, clay and silt.
B. CHEMICAL SEDIMENTARY ROCKS	
ROCK NAME	MAIN MATERIAL
LIMESTONE	Calcite.
DOLOMITE	Dolomite
CHERT	Quartz

A modifier may be necessary to describe a sedimentary rock formed from a combination of different soil types, i.e., a “silty SANDSTONE” would be predominantly composed of sand grains with a lesser amount of silt grains. This distinction is only necessary when the modifier has engineering significance. The term mudstone could be used when the composition of the sedimentary rock is uncertain or variable.

### 5.5.1.4 Metamorphic Rocks

Table 5-21 Common Metamorphic Rocks

A. FOLIATED METAMORPHIC ROCKS			
ROCK NAME	TEXTURE	FORMED FROM	MAIN MATERIALS
SLATE	Platy, fine-grained	Shale, argillite	Clay, mica, quartz
PHYLLITE	Parting surfaces (foliation) defined by fine-grained platy minerals (mica, graphite, etc.) giving the surfaces a silky sheen.	Slate	Mica, clay, quartz
SCHIST	Irregular layers, medium grained	Slate/phyllite, igneous rocks	Mica, quartz, feldspar, amphibole
GNEISS	Layered, coarse-grained	Igneous rocks, schist, sandstone	Mica, quartz, feldspar, amphibole
B. NONFOLIATED METAMORPHIC ROCKS			
ROCK NAME	TEXTURE	FORMED FROM	MAIN MATERIALS
MARBLE	Crystalline	Limestone, dolomite	Calcite, dolomite
QUARTZITE	Crystalline	Sandstone	Quartz
SERPENTINITE	Massive to layered, fine- to coarse-grained	Ultramafic rocks, i.e., peridotite, gabbro	Serpentine-group (antigorite, lizardite, and chrysotile [asbestos])

### 5.5.2 Color

Rock color is not in itself a specific engineering property, but may be an indicator of the influence of other significant conditions such as groundwater (e.g., mottling indicating wet/dry cycles), and alteration/weathering. Color may also be an aid in subsurface correlation.

Color should be determined from a freshly broken surface. Describe the “net” color of the rock mass. Wetting the rock sample may be necessary if drying has occurred or when determining the color from the cut surface of a core sample. Use the Rock Color Chart (Munsell Color System) to determine the color(s) of the rock. Record the color name and the alpha-numeric notation and whether the sample is dry or wet: i.e. Dark yellowish brown, 10YR 4/2 (D or W). Avoid listing more than two colors except when describing multi-colored mottling or large-scale color variations within a rock mass.

### 5.5.3 Degree Of Weathering

Weathering and alteration should be described as part of the rock classification. Weathering is the process of mechanical and/or chemical breakdown of rocks through exposure to the elements, which include rain, wind, plant action, groundwater, ice, and changes of temperature. In general, the strength of rock tends to decrease as the degree of weathering increases. In the earliest stages, weathering is manifested by discoloration of intact rock and only slight changes in rock texture. With time, significant changes in rock strength, compressibility, and permeability occur. And the rock mass is altered until the rock is decomposed to soil. For determining the stage of weathering for rock, use Table 5-22, Scale of Relative Rock Weathering. For example, a basalt that is more than 50 percent decomposed (but not completely) would be described as “BASALT, predominantly decomposed.” The degree of weathering should be determined for each rock core sample. Multiple designations would be required for variable rock conditions.

In select cases, the term alteration may be used, which applies specifically to changes in the chemical or mineral composition of rock due to hydrothermal or metamorphic activity. Alteration may occur as zones and pockets and can be found at depths far below that of normal rock weathering. Separate the terms weathering and alteration, since alteration does not strictly infer a reduction in rock strength. For example, a gray basalt that is closely jointed with extensive hydrothermal alteration and secondary mineralization may exhibit only slight weathering along joint surfaces and would be described as “BASALT, gray, slightly weathered, close jointed, extensive hydrothermal alteration with secondary mineralization.”

Table 5-22 Scale of Relative Rock Weathering

DESIGNATION	FIELD IDENTIFICATION
<b>Fresh</b>	Crystals are bright. Discontinuities may show some minor surface staining. No discoloration in rock fabric.
<b>Slightly Weathered</b>	Rock mass is generally fresh. Discontinuities are stained and may contain clay. Some discoloration in rock fabric. Decomposition extends up to 1 inch into rock.
<b>Moderately Weathered</b>	Rock mass is decomposed 50 percent or less. Significant portions of rock show discoloration and weathering effects. Crystals are dull and show visible chemical alteration.

DESIGNATION	FIELD IDENTIFICATION
	Discontinuities are stained and may contain secondary mineral deposits.
<b>Predominantly Decomposed</b>	Rock mass is more than 50 percent decomposed. Rock can be excavated with a rock hammer. All discontinuities exhibit secondary mineralization. Complete discoloration of rock fabric. Surface of core is friable and usually pitted due to washing out of highly altered minerals by drilling water.
<b>Decomposed</b>	Rock mass is completely decomposed. Original rock fabric may be evident. May be reduced to soil with hand pressure.

### 5.5.4 Relative Strength Of Rock

Differentiating between rock and soil, for engineering purposes, is based primarily on values of unconfined compressive strength. Rock strength may be estimated through manual field tests yielding a “field classification,” which can be refined through laboratory testing. The scale of rock strength to be used is presented on Table 5-23. The relative strength of rock should be determined for each rock core sample; multiple designations would be required for variable rock conditions, such as changes in weathering and joint filling.

**Table 5-23 Scale of Relative Rock Strength**

TERM	STRENGTH DESIGNATION	FIELD CLASSIFICATION	APPROXIMATE UNCONFINED COMPRESSIVE STRENGTH (PSI)
<b>Extremely weak</b>	R0	Indented by thumbnail	35-150
<b>Very weak</b>	R1	Crumbles under firm blows with point of a rock hammer, can be peeled by a pocket knife	150-725
<b>Weak</b>	R2	Can be peeled with a pocket knife with difficulty, shallow indentation made by firm blow with point of a rock hammer	725-3,500
<b>Medium strong</b>	R3	Cannot be scraped or peeled with a pocket knife, specimen can be	3,500-7,250

TERM	STRENGTH DESIGNATION	FIELD CLASSIFICATION	APPROXIMATE UNCONFINED COMPRESSIVE STRENGTH (PSI)
		fractured with a single blow from a rock hammer	
<b>Strong</b>	R4	Specimen requires more than one blow of a rock hammer to fracture it	7,250-14,500
<b>Very strong</b>	R5	Specimen requires many blows of a rock hammer to fracture it	14,500-36,250
<b>Extremely Strong</b>	R6	Specimen can only be chipped with a rock hammer	>36,250

## 5.5.5 Structure

Structure refers to large-scale (megascopic) planar or oriented features which are significant to the overall strength, permeability, and breakage characteristics of the rock unit. Planar structural features include joints, bedding, and faults. These terms are defined below. Other oriented structural features include mineral/grain orientation (i.e., foliation, flow banding, and folded originally planar features) or root holes.

### 5.5.5.1 Joints.

Planar breaks or fractures in rock along which no movement has occurred parallel to the fracture surface are defined as joints. They may range from perpendicular to parallel in orientation with respect to bedding. Repetitive patterns of more or less parallel joints is called a joint set. Two or more joint sets or a pattern of joints define a joint system. The number of joint sets is most reliably obtained from rock exposures.

### 5.5.5.2 Stratification.

Stratification of rock is evidenced by changes in texture, composition, age, or unique forms. Bedding applies primarily to sedimentary and pyroclastic rocks. Other terms related to stratification are defined in Table 5-24.

Table 5-24 Stratification Terms

TERM	CHARACTERISTICS
<b>Laminations</b>	Thin beds (<1 cm).

TERM	CHARACTERISTICS
Fissile	Tendency to break along laminations.
Parting	Tendency to break parallel to bedding, any scale.
Foliation	Non-depositional, e.g., segregation and layering of minerals in metamorphic rocks.

### 5.5.5.3 Joint Or Bedding Spacing.

In determining the range of distances between individual joints or beds, care must be taken to distinguish between joints and mechanical breaks that are caused by handling or drilling. These types of mechanical breaks are typically rough and irregular, showing a fresh rock surface and are disregarded for description. Some mechanical breaks, though, may be caused by handling or drilling, but occur along existing joints or fractures, and should be described accordingly. Joint/bedding spacing is based on Table 5-25.

Table 5-25 Joint and Bedding Spacing Terms

SPACING	JOINT SPACING TERMS	BEDDING/FOLIATION SPACING TERMS
Less than 2 in.	Very close	Very thin (laminated)
2 in. to 1 ft.	Close	Thin
1 ft. to 3 ft.	Moderately close	Medium
3 ft. to 10 ft.	Wide	Thick
More than 10 ft.	Very wide	Very thick (massive)

Planar breaks or fractures, along which displacement has occurred parallel to the fracture surface are termed faults. The presence of gouge (pulverized rock), bedding offset, and polished or slickensided surfaces (commonly with mineral or clay coating), may be indicators of fault movement. However, not all slickensides are caused by faulting: slickensides can be caused by deformation (i.e., folds, flows) or landsliding. When offset is apparent, indicate the relative sense of movement (normal, reverse, or strike-slip)

### 5.5.5.4 Attitude.

The orientation of joints, faults, bedding planes or other planar features must be determined and recorded. Figure 5-6 presents the orientation information that should be identified/measured. Strike and dip of joint and bedding planes are usually measured in test pits or on outcrops, since core obtained in most drilling operations will not be properly oriented.

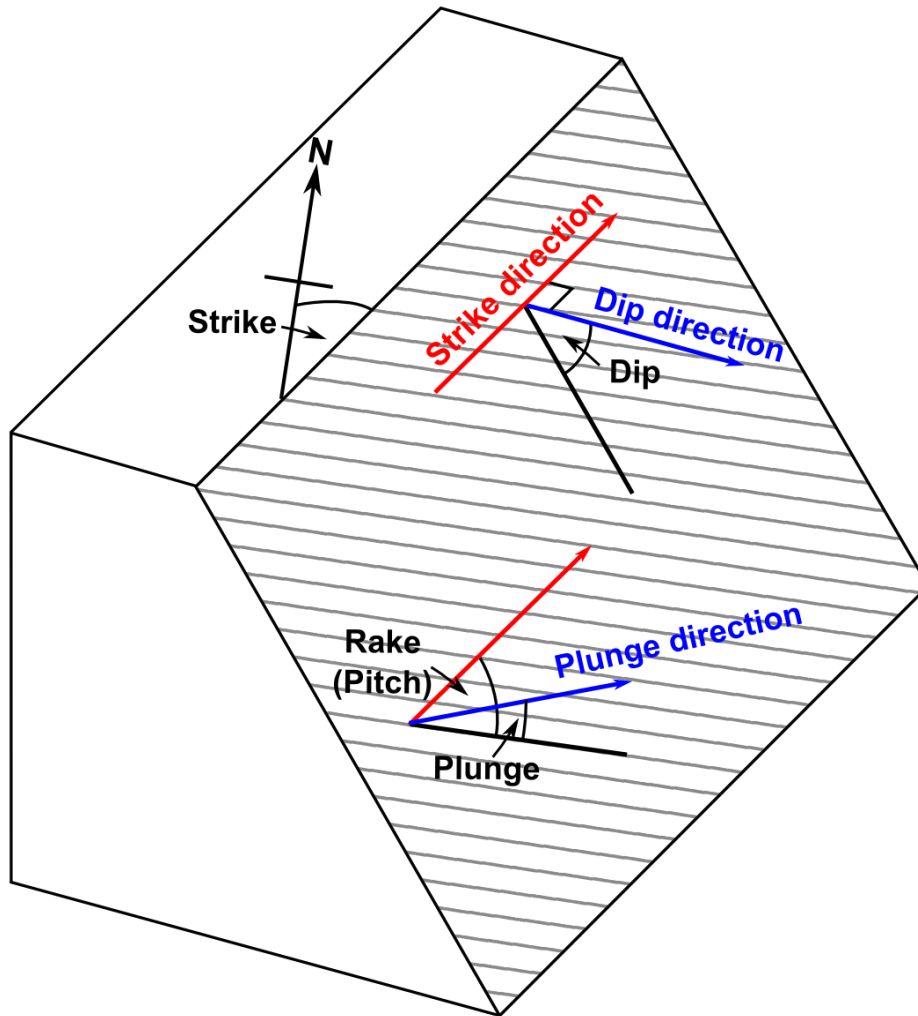

Figure 5-6 Orientation Measurements of Planar and Linear Features

(Norton, 2010)

### 5.5.5.5 Core

Unless oriented core is obtained, the true orientation (strike and dip) of discontinuities cannot be determined. The inclination (dip) of a joint or bedding plane is measured perpendicular to the strike trace of the feature and down from horizontal. Joint sets and bedding may be characterized by the average inclination observed in the sample. For unique discontinuities, such as faults and widely spaced or random joints, determine the inclination for each feature.

The angle that striations (slickensides) make with a horizontal line is known as the "rake", as shown on Figure 5-6. Determine the rake for any linear features observed on discontinuity surfaces.

### **5.5.5.6 In Situ**

Joint and bedding planes should be described in terms of orientation, i.e., strike and dip. Linear features (striations and slickensides) should be described in terms of rake or bearing and plunge. Primary and secondary joint sets should be defined where possible. Typically in rock, one joint set may yield slabs, two intersecting joint sets may yield wedges, and three or more intersecting joint sets may yield blocks or highly fragmented rock.

Additional information of rock structure can be found in [Chapter 11](#) of the GDM.

### **5.5.5.7 Separation.**

The separation or relative openness of joints may be described as:

- a) Open. An existing planar surface that is separated or separates easily when handled and may have mineralization or staining/weathering on the joint surfaces. Where measureable, identify the opening width (aperture). Open joints are possible groundwater drainage paths.
- b) Closed. An existing planar surface that separates with greater difficulty, seen as a “hairline” trace on the outside of the sample/core, and usually contains soil or minerals as a filling between joint surfaces.
- c) Healed. Breaks open easily or with difficulty, seen either as a hairline trace or seam of some thickness on the outside of the sample/core, and usually contains soil or minerals as a filling between joint surfaces.

### **5.5.5.8 Filling.**

This term refers to the material in the space between adjacent surfaces of a discontinuity. The filling material may consist of weathered or hydrothermally altered products, secondary mineral precipitates, or gouge. The material description and thickness of the filling material should be reported.

### **5.5.5.9 Continuity.**

Continuity is an expression of the lateral extension of the discontinuity, as measured or projected along its strike and dip. Continuity is a very important property of the rock mass, as a single continuous joint may actually control the behavior of the entire mass. Whether or not joints are continuous may require test pit, outcrop, or additional borehole information for confirmation. The description of joint continuity, as defined in Table 5-26, should include an indication of certainty and the method of observation. Where continuity cannot be determined in core specimens, it should be noted as “Indeterminate”.



Table 5-26 Degree of Continuity

TERM	LENGTH
Discontinuous	0 to 5 feet
Slightly Continuous	5 to 10 feet
Continuous	10 to 40 feet
Highly Continuous	>40 Feet

### 5.5.5.10 Geological Strength Index

The Geological Strength Index (GSI), when combined with the intact rock properties, can be used for estimating the reduction in rock mass strength for different geologic conditions. This system is presented in Table 5-27, for blocky rock masses, and Table 5-28 for heterogeneous rock masses such as flysch, molasse and mélange/ophiolite.

A GSI should be determined for each rock core sample; multiple values may be required for variable joint conditions, such as changes in spacing or surface conditions. Record the GSI in the Discontinuity Data column of the log as "GSI=XX".

Table 5-27 GSI for blocky rock masses on the basis of interlocking and joint surface conditions











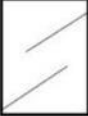

<p>GEOLOGICAL STRENGTH INDEX FOR JOINTED ROCKS (Hoek and Marinos, 2000)</p> <p>From the lithology, structure and surface conditions of the discontinuities, estimate the average value of GSI. Do not try to be too precise. Quoting a range from 33 to 37 is more realistic than stating that GSI = 35. Note that the table does not apply to structurally controlled failures. Where weak planar structural planes are present in an unfavourable orientation with respect to the excavation face, these will dominate the rock mass behaviour. The shear strength of surfaces in rocks that are prone to deterioration as a result of changes in moisture content will be reduced if water is present. When working with rocks in the fair to very poor categories, a shift to the right may be made for wet conditions. Water pressure is dealt with by effective stress analysis.</p>		SURFACE CONDITIONS				
		VERY GOOD Very rough, fresh unweathered surfaces	GOOD Rough, slightly weathered, iron stained surfaces	FAIR Smooth, moderately weathered and altered surfaces	POOR Slickensided, highly weathered surfaces with compact coatings or fillings or angular fragments	VERY POOR Slickensided, highly weathered surfaces with soft clay coatings or fillings
STRUCTURE		DECREASING SURFACE QUALITY →				
	INTACT OR MASSIVE - intact rock specimens or massive in situ rock with few widely spaced discontinuities	90			N/A	N/A
	BLOCKY - well interlocked undisturbed rock mass consisting of cubical blocks formed by three intersecting discontinuity sets	80	70			
	VERY BLOCKY - interlocked, partially disturbed mass with multi-faceted angular blocks formed by 4 or more joint sets		60	50		
	BLOCKY/DISTURBED/SEAMY - folded with angular blocks formed by many intersecting discontinuity sets. Persistence of bedding planes or schistosity			40		
	DISINTEGRATED - poorly interlocked, heavily broken rock mass with mixture of angular and rounded rock pieces				30	
	LAMINATED/SHEARED - Lack of blockiness due to close spacing of weak schistosity or shear planes					20
						10
		N/A	N/A			

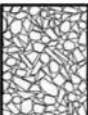
Table 5-28 GSI for heterogeneous rock masses such as flysch.

GSI FOR HETEROGENEOUS ROCK MASSES SUCH AS FLYSCH (Marinos.P and Hoek. E, 2000) From a description of the lithology, structure and surface conditions (particularly of the bedding planes), choose a box in the chart. Locate the position in the box that corresponds to the condition of the discontinuities and estimate the average value of GSI from the contours. Do not attempt to be too precise. Quoting a range from 33 to 37 is more realistic than giving GSI = 35. Note that the Hoek-Brown criterion does not apply to structurally controlled failures. Where unfavourably oriented continuous weak planar discontinuities are present, these will dominate the behaviour of the rock mass. The strength of some rock masses is reduced by the presence of groundwater and this can be allowed for by a slight shift to the right in the columns for fair, poor and very poor conditions. Water pressure does not change the value of GSI and it is dealt with by using effective stress analysis. COMPOSITION AND STRUCTURE		SURFACE CONDITIONS OF DISCONTINUITIES (Predominantly bedding planes)	VERY GOOD - Very rough, fresh unweathered surfaces	GOOD - Rough, slightly weathered surfaces	FAIR - Smooth, moderately weathered and altered surfaces	POOR - Very smooth, occasionally slickensided surfaces with compact coatings or fillings with angular fragments	VERY POOR - Very smooth slickensided or highly weathered surfaces with soft clay coatings or fillings
 <p><b>A. Thick bedded, very blocky sandstone</b> The effect of pelitic coatings on the bedding planes is minimized by the confinement of the rock mass. In shallow tunnels or slopes these bedding planes may cause structurally controlled instability.</p>			70 60	A			
 <p><b>B. Sandstone with thin inter-layers of siltstone</b></p>	 <p><b>C. Sandstone and siltstone in similar amounts</b></p>	 <p><b>D. Siltstone or silty shale with sandstone layers</b></p>	 <p><b>E. Weak siltstone or clayey shale with sandstone layers</b></p>		50 40	B C D E	
<p>C,D, E and G - may be more or less folded than illustrated but this does not change the strength. Tectonic deformation, faulting and loss of continuity moves these categories to F and H.</p>		 <p><b>F. Tectonically deformed, intensively folded/faulted, sheared clayey shale or siltstone with broken and deformed sandstone layers forming an almost chaotic structure</b></p>			30 20	F	
 <p><b>G. Undisturbed silty or clayey shale with or without a few very thin sandstone layers</b></p>	 <p><b>H. Tectonically deformed silty or clayey shale forming a chaotic structure with pockets of clay. Thin layers of sandstone are transformed into small rock pieces.</b></p>				10	G H	

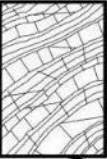
→ : Means deformation after tectonic disturbance

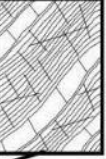
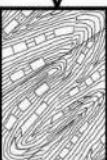
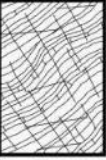
## 5.5.6 Core Recovery And Rock Quality Designation (RQD)

Core recovery and the Rock Quality Designation are measured indicators of the quality and structure of rock. Both the core recovery and the RQD should be determined and recorded on the field boring log for each core run. The core recovery is the measured length of core retained in the core barrel. The percent recovery is the measured recovery divided by the total run length expressed as a percent. Record the measured recovery in the appropriate column and the percent recovery at the end of the sample description.

The RQD provides a subjective estimate of rock mass quality/structure. The RQD is a modified core recovery percentage in which only pieces of intact rock core 4 inches or greater in length are measured (average length). The smaller pieces are considered to be the result of close jointing, fracturing, or weathering in the rock mass, and are therefore excluded from the RQD determination. RQD is defined as the cumulative total length of all pieces 4 inches long or longer divided by the total run length, expressed as a percentage. Mechanical breaks, such as caused by handling or drilling, should be noted as such and not included in the RQD calculations. Completely healed joints, veins, and mineralization zones should be treated in the same manner as mechanical breaks.

In some cases, where significant soil is encountered at one end of the core run, the RQD should be determined on the basis of rock core length recovered: where this is done it should be clearly defined. RQD is not applicable to fissile rocks such as shales. Difficulties such as distinguishing natural fractures in the rock core from mechanical breaks and the insensitivity of the RQD to the tightness of individual joints may limit the use of the RQD in evaluating in situ rock properties.

Record the RQD in the Discontinuity Data column of the log as "RQD=XX%".

## 5.5.7 Other Rock Characteristics

Other physical characteristics should be described, depending on the scope and objectives of the project. These may include the following:

### 5.5.7.1 Mineralization.

Secondary mineralization is the introduction of new minerals to a rock mass from an outside source, or through alteration of existing materials. Mineralization may occur in voids, along joints, or within the ground mass.

Iron-oxide staining usually indicates the static groundwater level may fluctuate within the discolored zone. The iron-oxide may only be a discoloration of surfaces, or an accumulation of bright orange material several inches thick and varying in hardness. Sulfide or carbonate minerals, such as pyrite or calcite, may be present and could denote groundwater of high mineral or bicarbonate content. Alteration products may indicate an increase in

hardness/brittleness (i.e., silicification, usually due to hydrothermal alteration), or reduction of rock strength if soft clay minerals have developed along joints or replaced major constituent minerals (e.g., the feldspar crystals in basalt altered to clay).

### **5.5.7.2 Slaking.**

The tendency for rock to disintegrate under conditions of wetting and drying, or when exposed to air is called slaking. This behavior is related primarily to the chemical composition of the material. It may be identified in the field if samples shrink and crack, or otherwise degrade upon drying, or being exposed to the air for several hours. If degradation occurs, and slaking is suspected, an air dried sample may be placed in clean water to observe a reaction. The greater the tendency for slaking, the more rapidly degradation will occur. This tendency should be expressed on field logs as “potential for slaking”, and can be confirmed through laboratory testing.

### **5.5.7.3 Field Unit Weight.**

The unit weight of rock can be important and useful in engineering design and practice. The unit weight can be determined by performing a field bulk specific gravity test and multiplying by the unit weight of water to get the rock unit weight. The procedure consists of weighing the sample in air (B) and then weighing it in water (C).

$$\gamma_{field} = \left[ \frac{B}{(B - C)} \right] \times (62.4 \text{ lbs/ft}^3)$$

### **5.5.7.4 Discontinuity Surface Condition.**

If applicable to the project, the joint/fault surfaces should be inspected and the surface condition described. Joint surface roughness can be defined in terms of a Joint Roughness Coefficient (JRC), which requires estimation or measurement of the surface unevenness, i.e., rough or smooth undulation, rough or smooth nearly planar. The JRC should be determined in the direction of anticipated block movement. Surface roughness is best determined on in-place discontinuities rather than core samples. For further detail see References 5, 6, and 13.

### **5.5.7.5 Voids.**

Open spaces in sedimentary and metamorphic rocks are generally caused by chemical dissolution or the action of running water. Since most of these voids result from the action of groundwater, the openings are usually elongate in the horizontal plane. The size of voids, where significant, should be measured and recorded with the rock classification.

## **5.5.8 Formation Name**

Rock units are generally known by group or formation names (i.e., Columbia River Basalt [Group], Astoria Formation, Otter Point Formation) and can be identified within project boundaries by examination of core samples, rock outcrops, and geologic literature. Where the formation name is known, it should be included at the end of the rock classification.

## 5.6 Field Exploration Logs

The primary roles of the field geologist or engineer are recording exploration activities on the standard form, collecting samples in accurately labeled containers, description of samples according to this manual, and transporting samples to the office or laboratory. Field exploration log data may be entered into the gINT® software at this point, although additional information including check classification and laboratory testing results make changes likely.

A field log must be produced for each exploratory boring, hand-auger hole, probe hole, and test pit. The log can also be used to describe soil and rock in cut slopes and outcrops. Soil and rock descriptions/classifications and terminology should be consistent with this manual.

Abbreviations are to be avoided unless they are defined on the log form. Log forms are provided for use in the field and are printed on water-resistant media (“Rite-In-The-Rain®” or “DuraRite®”). Figures 6.1a and 6.1b display the front and back of the ODOT standard log form.

The field log must contain basic reference information at the top, including project name, purpose of the boring, location and elevation, **exploration hole number**, start and end dates, total depth, drilling equipment, personnel, etc. The location can be **approximate** coordinates (project coordinates or Lat./Long.), alignment station and offset, intersecting road names (include intersection quadrant or distance and direction), nearby roadway feature (manhole, sign support, utility/luminaire pole, etc.; include distance and direction).

The field log is a record which should contain all of the information obtained from an exploratory hole whether or not it may seem important at the time of the exploration.

On field logs. Linear measurements, depths, etc., should be measured and recorded to the nearest 0.1 foot. The total depth of drilling and date/time should be recorded in the remarks section of the log at the end of each day and at completion of the exploration.

A list/description of any instrumentation installed should be written at the end (bottom) of each exploration log.

### 5.6.1 Sample Logging

The log form includes columns for depth, test type and number, measured recovery, driving resistance/discontinuity data, graphic log, material description, drilling remarks, and backfill/instrumentation (Figures 5-7 & 5-8). Use of the graphic log and backfill/instrumentation columns is optional.

It is important to record all information in an accurate manner. Legibility is important. All soil and rock samples are to be fully described immediately on recovery. Referencing a previous sample is acceptable when performed thoughtfully.

The log form does not have a fixed scale, use as much space as needed for each description.

The following information is recorded for each sample.

#### 5.6.1.1 Depth

Record the start depth of the sample.

### **5.6.1.2 Test Type And Number**

Some common test-type abbreviations are provided on the log form. Tests are numbered sequentially by type (i.e. N-1, N-2; U-1, U-2; C-1, C-2; etc.). For drive samples, the standard 2-inch sampler is denoted "N" (N-1). A 3-inch sampler, used for recovering samples in gravel, is denoted "DM" (DM-2).

### **5.6.1.3 Measured Recovery**

Record the length of the sample in the sampler. Generally, the length should be equal to or less than the interval sampled.

#### Soil

The length of the typical drive sampler is 2.0 feet. The sample interval of a standard penetration test (SPT) is 1.5 feet. Measure the sample from bottom to top, including any sample in the sampler drive shoe. If the measured recovery exceeds the sampled interval, there are several likely explanations:

- The sampler penetrated some thickness of cuttings before reaching the test depth. This material is usually soft and/or fragmented and is easily differentiated from the actual sample. If the sampler is full, note the length of this material in the Drilling Remarks, as it can affect the observed driving resistance.
- The sampler was driven past the sample interval. This happens occasionally. If it happens frequently, the driller must take greater care during sampling.
- The soil is so soft that the sampler penetrates under its own weight and could not be stopped in time.
- The soil expanded in the sampler. This is rare and usually associated with peat or other highly organic soils. Some clays may also expand.

#### Rock

- The run length is the drilled/sampled interval. The length of a typical inner barrel is 5.0 feet and this defines the maximum run length. As with soil, the measured recovery is the length of the sample brought to the surface. For most rock, this is easily measured. In soft, highly fractured rock or rock-soil mixtures, reconstruct the sample to the approximate diameter of the core barrel and measure the reconstructed sample length.
- The measured recovery may occasionally be greater than the run length, especially if the run is shorter than the maximum length. This occurs when some core from the previous run remains in the barrel and is recovered during the next run and is usually due to a worn core lifter. Tool marks on the core sample may indicate where the "new" sample begins. Recovery should include only the "new" sample length. The length of the "old" sample should be recorded in the Drilling Comments and can be added to the recovery of the previous run.

### **5.6.1.4 Driving Resistance/Discontinuity Data**

- Driving resistance refers to soil and consists of the blow-count data from the standard penetration test. The blows for each 6-inch interval are recorded in the form X-X-X, where X is the number of blows for the first, second, and last 6-inch interval. Also record the N-value, which is the sum of the blow-counts for the last two 6-inch intervals. Refusal occurs when the sampler cannot be advanced 6 inches with 50 blows. Measure the penetration and record as 50/X" or 50 for X". If the sampler bounces, the test can be stopped and the results may be recorded as above. If the sampler bounces at the start of the test, record 50/0" and the test can be stopped. Continuing the test when the sampler is bouncing will likely damage the drive shoe and will not provide any additional useful data.
- Discontinuity data refers to rock. There are two components: Rock Quality Determination (RQD) and Geological Strength Index (GSI). Determine the values of RQD and GSI as described in Chapter 5 and record them in this column.





EXPLORATION LOG  
OREGON DEPARTMENT OF TRANSPORTATION

Page \_\_\_\_\_ of \_\_\_\_\_

Project				Purpose			Hole No.				
Highway				County			E.A. No.				
Hole Location				Driller			Key No.				
Equipment				Recorder			Start Card No.				
Project Geologist				Total Depth			Bridge No.				
Start Date				End Date			Ground Elev.				
Test Type				Rock Abbreviations			Typical Drilling Abbreviations				
"A" - Auger Core "X" - Auger "C" - Core, Barrel Type _____ "N" - Standard Penetration "U" - Undisturbed Sample				<u>Discontinuity</u> J - Joint F - Fault B - Bedding Fo - Foliation S - Shear			<u>Shape</u> Pl - Planar C - Curved U - Undulating St - Stepped Ir - Irregular				
				<u>Surface Roughness</u> P - Polished Sl - Slickensided Sm - Smooth R - Rough VR - Very Rough			<u>Drilling Methods</u> WL - Wire Line HS - Hollow Stem Auger DF - Drill Fluid SA - Solid Flight Auger CA - Casing Advancer HA - Hand Auger				
				<u>Drilling Remarks</u> LW - Lost Water WR - Water Return WC - Water Color D - Down Pressure DR - Drill Rate DA - Drill Action							
Depth (meters)	Test Type, No.	Measured Recovery (meters)	Soil	Rock	Driving Resistance	Discontinuity Data	Graphic Log	Material Description SOIL: Soil Name, USCS, Color, Plasticity, Moisture, Consistency/Relative Density, Texture, Cementation, Structure, Origin. ROCK: Rock Name, Color, Weathering, Hardness, Discontinuity Spacing, Joint Filling Core Recovery, RQD, Formation Name.	Drilling Methods, Size and Remarks	Water Level/Date	Backfill/Instrumentation

734-3978(6-95)

Figure 5-7 Standard log form-front



### 5.6.1.5 Material Description

The log form provides reminders for the components of soil and rock descriptions, in the order they should be recorded.

#### *Soil*

Soil Name, USCS, Color, Plasticity, Moisture, Consistency/Relative Density, Texture, Cementation, Structure, Origin/Formation.

Each sample description starts with the sample type and number, followed by the sampled interval:

N-3 (7.5-9.0)

*Material Description/Classification as described in Chapter 5.*

If more than one material type is present in the sample, use the following format:

N-3 (7.5-9.0)

N-3a (7.5-8.1)

*Material Description/Classification as described in Chapter 5.*

N-3b (8.1-9.0)

*Material Description/Classification as described in Chapter 5.*

Etc.

Each material must be placed in a separate container.

When referencing a previous sample, use the following format:

N-3 (7.5-9.0)

Silty SAND, as in N-2

#### *Rock*

Rock Name, Color, Weathering, Strength, Discontinuity Spacing, Joint Filling, Core Recovery, RQD, Formation Name.

The general formats are the same as those for soil.

*Some notes on describing discontinuities/joints:*

- “Discontinuity” and “Joint” are often used interchangeably. All joints are discontinuities, but not all discontinuities are joints. Fractures, partings, and faults are also discontinuities.
- Include the following for each joint set present in the core sample: spacing, attitude, separation, and filling.
- Individual, significant, discontinuities, especially faults, shall be described as above and include the depth to the center of the discontinuity, the rake of any slickensides, and a description of any gouge or filling.

- In the field, angles can be measured (preferred) or estimated. If estimated angles are recorded, those angles should be confirmed by measurement, prior to check-classification. An inexpensive plastic or metal goniometer (angle ruler, swing-arm protractor) will aid angle measurement.

### **5.6.1.6 Drilling Remarks**

Drilling remarks are observations made during drilling in addition to sample descriptions. Subsurface conditions are not always fully characterized by depending solely on material descriptions. Therefore, any comments with regard to the character of drilling and difficulties encountered while advancing the boring should be included on the exploration log. These observations can provide valuable supplemental information for the design of foundations, excavations, performance of fills, and other geotechnical designs.

Drilling remarks may include:

- Drilling method(s)
- Obstructions
- Difficulties in drilling (caving, heaving sand, caverns, etc.)
- Loss of circulation and possible cause
- Estimated percent drill fluid return and applied pump pressure
- Color of drill fluid return
- Return drill fluid constituents
- Relative drilling down-pressure and depth of major pressure changes
- Drilling action, i.e. drill chatter, smooth, bouncy, etc.
- Length of time for each drill run
- Possible reason(s) for incomplete sample recovery (SPT, Shelby, core)
- Approximate depth to first encountered groundwater
- Artesian pressure or elevation head, and depth where encountered
- Reasons for using drilling muds, casing, or special drill bits.
- Equipment problems or breakdowns
- Hole abandonment information (materials used and depths/intervals)

## **5.7 Check Classification Of Soil And Rock**

Check classification is a part of the overall QA/QC process (ODOT GDM, Ch. 2). Check classification is performed to provide verification of the soil and rock classifications derived in the field. Check classification also provides process improvement by detecting systematic errors in the field classifications. The check classification must be performed by an engineering geologist (preferred) or geotechnical engineer experienced in soil and rock classification and not a participant in the field logging. Typically, the check classifications are performed by the engineering geology reviewer or the project engineering geologist (if logging was performed by other staff).

Check classification compares the elements of the sample descriptions (classifications) with the samples. Notes and comments are recorded on a copy of the field log, along with the checker’s name and the date of the check classification. These check classification logs should be retained as part of the project QC documentation. The results of the check classification effort should be discussed with the field personnel and the project engineering geologist.

### **5.7.1 Check Classification Of Soil**

The checker reviews each sample description and compares it to the sample. This includes performing the appropriate field index tests. The following table outlines the general workflow for soil.

**Table 5-29 General check classification workflow for soil.**

<b>Property</b>	<b>Comment</b>
<b>Color</b>	Color may be different due to oxidation, especially in fine-grained soil. Compare to fresh material if available. Comment as appropriate.
<b>Plasticity</b>	Perform field test, correct as necessary.
<b>Moisture</b>	Compare and correct as appropriate.
<b>Consistency/Relative Density</b>	Check N-value and plasticity. Correct as necessary.
<b>Texture</b>	Compare and correct as necessary.
<b>Cementation</b>	Compare and correct as necessary.
<b>Structure</b>	Compare and correct as necessary.
<b>Soil Name</b>	Correct as necessary.
<b>USCS</b>	Correct as necessary.
<b>Origin</b>	Comment as appropriate.

The checker should include any observations omitted from the field description. For example, the presence of iron oxide, minor amounts of organics, mottling, odor, etc. The checker should recommend laboratory index tests in cases where the field and check classifications differ significantly. These recommendations should be noted on the check classification log.

## 5.7.2 Check Classification Of Rock

As with soil, the checker reviews each sample description and compares it to the sample. This includes performing the appropriate field tests. The following table outlines the general workflow for rock.

Table 5-30 General check classification workflow for rock.

Property	Comment
Recovery	Measure and correct as necessary.
Rock Name	Compare and correct as necessary.
Color	Compare and correct as necessary. May require wetting of sample.
Weathering	Compare and correct as necessary.
Strength	Compare and correct as necessary.
Discontinuity Angle, Spacing, Surface Condition/Filling	Compare and correct as necessary.
GSI	Compare and correct as necessary.
RQD	Calculate and correct as necessary.
Formation Name	Comment as appropriate.

The checker should include any observations omitted from the field description. For example, the presence of iron oxide, vesicles, mottling, odor, etc. The checker should recommend laboratory index tests in cases where the field and check classifications differ significantly. These recommendations should be noted on the check classification log.

## 5.8 Final Exploration Logs

Final logs incorporate the field log information, surveyed location data, check classification results, and laboratory test results. The final log may also include drilling remarks, results of

specialized field tests and any instrumentation data available. The final log also includes geologic/geotechnical unit descriptions.

Final exploration logs are prepared using the gINT® software. The format of the log is standardized statewide. Each project will be recorded in a separate gINT® database. This process may have begun as part of the field exploration program, but some significant changes to this existing data should be anticipated.

Once complete, the laboratory test results are entered into the gINT program for inclusion on the exploration log where appropriate. The laboratory results are used to refine sample descriptions which then necessitate adjustments to the engineering geologic units. These changes may be simple changes to the descriptions and classifications. Adjustments to the units themselves may be needed if the lab test results require it. As the project geologist compiles the logs in this iteration, the engineering geologic units in the individual borings are complete enough to construct a preliminary or intermediate geologic model of the site. The project geologist should review the relationships between explorations in the model. Where necessary, adjustments to the units may take place based on stratigraphic position, material properties, or other engineering geologic considerations. Finally, the project engineer and geologist review the subsurface model together to consider any final adjustments to support engineering analysis.

## 5.9 References

American Geosciences Institute (AGI), 2011, *Glossary of Geology*, 5<sup>th</sup> ed.

Field Studies Council, 2016, *Coastal Processes Fieldwork*.

<https://www.geography-fieldwork.org/gcse/coasts/coastal-processes/fieldwork/>

Hoek, E., 2007, *Practical Rock Engineering*: Rocscience, Inc.

Marinos, Paul, and Evert Hoek. "GSI: A Geologically Friendly Tool For Rock Mass Strength Estimation." Paper presented at the ISRM International Symposium, Melbourne, Australia, November 2000.

Norton, M., 2010, [Mikenorton](#), Creative Commons: Licensed under the [Creative Commons Attribution-Share Alike 3.0 Unported](#) license

Powers, M.C., 1953, A new roundness scale for sedimentary particles: *Journal of Sedimentary Petrology*, 23:117-119.

Rothwell, R.G., 1989. *Minerals and Mineraloids in Marine Sediments: An Optical Identification Guide*, Elsevier.

U.S. U.S. Department of the Interior, Bureau of Reclamation (2001), *Engineering Geology Field Manual*, 2nd Edition.



# Chapter 6 - Engineering Properties of Soil and Rock



## Chapter Contents

<b>Chapter 6 - Engineering Properties of Soil and Rock .....</b>	<b>6-1</b>
6.1 General.....	6-2
6.2 Influence of Existing and Future Conditions on Soil and Rock Properties .....	6-2
6.3 Methods of Determining Soil and Rock Properties.....	6-3
6.4 In-Situ Field Testing.....	6-3
6.5 Laboratory Testing of Soil and Rock .....	6-5
6.6 Engineering Properties of Soil.....	6-5
6.7 Engineering Properties of Rock.....	6-5
6.8 Final Selection of Design Values .....	6-6
6.9 Development of the Subsurface Profile .....	6-7
6.10 References .....	6-8

## 6.1 General

The purpose of this chapter is to identify appropriate methods of geotechnical soil and rock property assessment to establish engineering parameters for geotechnical design. Geotechnical soil and rock design parameters should be based on the results of a complete geotechnical investigation, which includes in-situ field-testing and a laboratory-testing program. The Geotechnical Engineer determines which geotechnical soil and rock design parameters are critical to project design and prepare a laboratory testing program. [Chapter 3](#) provides guidance on how to plan a geotechnical investigation.

The detailed measurement and interpretation of soil and rock properties should be consistent with the guidelines provided in Loehr et al. (2016). The focus of geotechnical design property assessment and final selection should be on the individual geologic strata identified at the project site. A geologic stratum is characterized as having the same geologic depositional history, stress history, and general similarities throughout the stratum in terms of density, source material, and hydrogeology. It is recognized that the properties of a given geologic stratum at a project site are likely to vary significantly from point to point within the stratum. In some cases, a measured property value may be closer in magnitude to the measured property value of an adjacent geologic stratum rather than the measured properties at another point within the same stratum. However, soil and rock properties for design should not be averaged across multiple strata. It should be recognized that some properties (e.g., undrained shear strength in normally consolidated clays) may vary as a predictable function of a stratum dimension (e.g., depth below the top of the stratum). When the property within the stratum varies in this manner the design parameters should be developed taking this variation into account.

## 6.2 Influence of Existing and Future Conditions on Soil and Rock Properties

Geotechnical soil properties used for design are not intrinsic to soil type. They vary depending on factors, including in-situ soil stresses, groundwater level, seepage forces, and the rate/direction of foundation loading. Prior to evaluating geotechnical soil properties, it is important to determine how existing site conditions will change over the life of the project. For example, future construction (e.g. new embankments) may place new surcharge loads on the soil profile. It is also necessary to determine how geotechnical soil properties within the geologic strata will change over the design life of the project. Over time, normally consolidated clays can gain strength with increased effective soil stresses, over-consolidated clays in cut slopes may lose strength, and embankments composed of weak rock may lose strength.

## 6.3 Methods of Determining Soil and Rock Properties

Geotechnical soil and rock properties of geologic strata are typically determined using one or more of the following methods:

- In-situ testing data from the field exploration program;
- Laboratory testing; and
- Back analysis based on site performance data.

The most common in-situ test methods are the Standard Penetration Test (SPT), Shear Wave Velocity ( $V_s$ ), and Cone Penetration Test (CPT) with or without shear wave velocity and/or porewater pressure. Other in-situ tests, such as the Pressuremeter, Flat Dilatometer, and Vane Shear are used less frequently. In-situ tests for rock, including Borehole Dilatometer, Borehole Jack, Plate Load Test, and Vane Shear Test, are rarely performed.

A variety of laboratory tests to directly measure specific soil and rock engineering properties are discussed in Loehr et al. (2016).

Laboratory geotechnical soil and rock-testing programs may utilize soil and rock engineering index tests with established empirical correlations to estimate preliminary engineering properties of soil and rock. However, final geotechnical designs should be based on direct measurement of specific soil and rock engineering properties as discussed in Loehr et al. (2016).

The observational method, or use of back analysis, may be helpful to estimate the approximate engineering properties of soil or rock units based on measurement of with slope failures, embankment settlement, or settlement of existing structures.

- **Landslides or slope failures:** With landslides or slope failures, the process generally starts with determining the geometry of the failure and then determining the soil/rock parameters or subsurface conditions that cause the safety factor to approach 1.0. Often the determination of the back-calculated properties is aided by correlations with index tests or experience on other projects.
- **Embankment settlement:** For embankment settlement, a range of soil properties is generally determined based on laboratory performance testing on undisturbed samples. Monitoring of fill settlement and pore pressure in the soil during construction allows the soil properties and prediction of the rate of future settlement to be refined.
- **Structure settlement:** For structures such as bridges that experience unacceptable settlement or retaining walls that have excessive deflection, the engineering properties of the soils can sometimes be determined if the magnitudes of the loads are known. As with slope stability analysis, the geometry of the subsurface soil must be adequately known, including the history of the groundwater level at the site.

## 6.4 In-Situ Field Testing

Methods, standards, and typical applications regarding in-situ field tests, such as the Standard Penetration Test (SPT) and Electronic Piezocone Penetrometer Test (CPTu), are provided in

Loehr et al. (2016) and ASTM D5778 (ASTM, 2020), D3441 (ASTM, 2018), and D7400 (ASTM, 2019a).

In general, correlations between SPT N-values and geotechnical soil properties (i.e., soil peak friction angle, in-place density, etc.) should only be used for granular, cohesionless soils (Sand or Gravel). However, Gravel particles can plug the sampler, resulting in higher blow counts and over-estimation of soil friction angles. SPT N-values are not recommended to determine geotechnical soil properties of Silt or Clay soils. See [Chapter 7](#) for more information regarding the use of N-values for liquefaction analysis.

SPT N-values should be corrected for hammer efficiency in accordance with section 5.6.2 of Loehr et al. (2016).

ODOT requires that drilling contractors provide all automatic hammer or safety hammers that have energy measurement data. This data must have been calibrated within the last year for each drill rig used on a project performed at the time of drilling of a boring. Hammer efficiency should be supplied with the boring log.

The following values for energy ratios (ER) may be assumed if hammer specific data are not available:

- ER = 60% for conventional drop hammer using rope and cathead
- ER = 80% for automatic trip hammer

Hammer efficiency (ER) for specific hammer systems used in local practice may be used in lieu of the values provided. If used, specific hammer system efficiencies shall be developed in general accordance with ASTM D-4633 Standard Test Method for Energy Measurement for Dynamic Penetrometers (ASTM, 2016).

Corrections for rod length, hole size, and use of a liner may also be made, if appropriate. In general, these are only significant in unusual cases or where there is significant variation from standard procedures. These corrections may be significant for evaluation of liquefaction.

Information on these additional corrections may be found in: “*Proceedings of the NCEER Workshop on Evaluation of Liquefaction Resistance of Soils*”; Publication Number: MCEER-97-0022; T.L. Youd, I.M. Idriss (1997) and in “Cetin, K., Seed, R., et al.

N-values are also affected by overburden pressure. The effect should be corrected for if the design method or correlation being used is applicable. N-values corrected for both overburden and the efficiency of the field procedures used shall be designated as  $N_{1,60}$  as stated in Loehr et al. (2016).

Methods, standards, and typical applications regarding in-situ field tests regarding field measurement of permeability is presented in Loehr et al. (2016), and ASTM D 4043 (ASTM, 2017). If in-situ test methods are utilized to determine hydraulic conductivity, one or more of the following methods should be used:

- Well pumping tests
- Packer permeability tests
- Seepage Tests
- Slug tests

- Piezocone tests

## 6.5 Laboratory Testing of Soil and Rock

The primary purpose of laboratory testing is to measure physical soil and rock properties utilizing standard repeatable procedures to analyze soil or rock behavior under proposed ground loading conditions. Laboratory test data are also used to check field soil and rock classifications from the subsurface field exploration program. Details regarding specific types of laboratory tests and their use are provided in Loehr et al. (2016).

Improper storage, transportation, or handling of in-situ soil and rock samples can significantly alter their laboratory-tested geotechnical engineering properties. Quality control (QA) requirements are provided in Mayne, et al. (2002). Laboratories conducting geotechnical testing shall be appropriately accredited by ODOT and compliant with all rules, for qualifying testers, calibrating and verifications of testing equipment.

## 6.6 Engineering Properties of Soil

Laboratory soil testing is used to estimate strength, stress\strain, compressibility, and permeability characteristics. See Loehr et al. (2016) and Section 10, AASHTO LRFD for specific guidance and requirements regarding laboratory testing.

Soil strength tests shall be performed on high quality, relatively undisturbed in-situ specimens. However, it is difficult and frequently impossible to sample, transport, extrude and set-up testing for granular, cohesionless soils (Sand or Gravel) without excessively disturbing or completely obliterating the soil specimen.

Disturbed soil strength testing can be used to provide approximate strength data for back-analysis of existing slopes. It also provides strength data for final stability design and construction quality assurance of fill placement for highway earthwork and embankment materials.

Strength testing of compacted backfill generally yields good results, considering that the soil placement method, in-situ density and moisture content, can all be accurately recreated in the laboratory with a high degree of reliability.

Strength values of disturbed or remolded specimens may be used for evaluating residual shear strength of in situ soils or compacted fills.

## 6.7 Engineering Properties of Rock

Engineering properties of rock are generally controlled by the discontinuities within the rock mass and not the properties of the intact material. Therefore, engineering properties for the rock mass must be reduced from the measured properties of the intact pieces to account for "defects" in the rock mass as a whole - specifically considering discontinuities within the rock mass. A combination of laboratory testing of small samples, empirical analysis, and field observations should be employed to determine the engineering properties of rock masses. There should be a greater emphasis placed on visual observations and quantitative descriptions of the rock mass.

Rock properties can be divided into two categories: intact rock properties and rock mass properties.

- **Intact rock:** Intact rock properties are determined from laboratory tests on small samples typically obtained from coring, outcrops, or exposures along existing cuts. Engineering properties typically obtained from laboratory tests include specific gravity, unit weight, point load, and compressive strength.
- **Rock mass properties:** Rock mass properties are determined by visual examination and measurement of discontinuities within the rock mass, and how these discontinuities will affect the behavior of the rock mass when subjected to the proposed construction.

The methodology and related considerations provided by Loehr et al. (2016), should be used to assess the design properties for the intact rock and the rock mass - except fractured rock mass shear strength parameters should be in accordance with Hoek, et al. (2018). This updated method uses a Geological Strength Index (GSI) to characterize rock mass for estimating strength parameters, and has been developed based on re-examination of hundreds of tunnel and slope stability analyses. Hoek, et al. (2018) is considered the most accurate methodology and should be used for estimating fractured rock mass shear strength determination. Note that this method is only to be used for highly fractured rock masses in which the stability of the rock slope is not structurally controlled.

## 6.8 Final Selection of Design Values

The geotechnical designer should review the quality and consistency of the field and laboratory testing data and determine if the results are consistent with expectations based on experience from other projects in the area or in similar soil/rock conditions.

Inconsistencies between laboratory test results should be examined to determine possible causes and develop procedures to correct, exclude, or downplay the significance of any suspect data. Chapter 8 of Loehr et al. (2016) outlines a systematic procedure for analyzing data and resolving these inconsistencies.

Engineering judgment, combined with parametric analyses as needed, will be needed to make the final assessment and determination of each design property. This assessment should include a decision as to whether the final design value selected should reflect the interpreted average value for the property, or a value that is somewhere between the most likely average value and the most conservative estimate of the property. Design property selection should achieve a balance between the desire for design safety, cost effectiveness, and constructability of the design.

Depending on the availability of soil or rock property data and the variability of the geologic strata under consideration, it may not be possible to reliably estimate the average value of the properties needed for design. In such cases, the geotechnical designer may have no choice but to use a more conservative selection of design parameters to mitigate the additional risks created by potential variability or the scarcity of relevant data. Note that for those resistance factors that were determined based on calibration by fitting to allowable stress design, this property

selection issue is not relevant, and property selection should be based on the considerations discussed previously.

Processes and examples to make the final determination of properties to be used for design are provided by Loehr et al. (2016).

## 6.9 Development of the Subsurface Profile

The development of design property values should begin and end with the development of the subsurface profile. Test results and boring logs will likely be revisited several times as the data is developed and analyzed before the relation of the subsurface units to each other and their engineering properties are finalized.

The ultimate goal of a subsurface investigation is to develop a working model that depicts major subsurface layers exhibiting distinct engineering characteristics.

The end product is the subsurface profile, a two dimensional depiction of the site stratigraphy. The following steps outline the creation of the subsurface profile:

1. Complete the field and lab work and incorporate the data into the preliminary logs.
2. Lay out the logs relative to their respective field locations and compare and match up the different soil and rock units at adjacent boring locations, if possible. However, caution should be exercised when attempting to connect units in adjacent borings, as the geologic stratigraphy does not always fit into nice neat layers. Field descriptions and engineering properties will aid in the comparisons.
3. Group the subsurface units based on geologic stratigraphy and then associated engineering properties.
4. Create cross sections by plotting borings at their respective elevations and positions horizontal to one another with appropriate scales. If appropriate, two cross sections should be developed that are at right angles to each other so that lateral trends in stratigraphy can be evaluated when a site contains both lateral and transverse extents (i.e. a building or large embankment).
5. Analyze the profile to see how it compares with expected results and knowledge of geologic (depositional) history. Address any anomalies and unexpected results encountered during exploration and testing during the profile development process. Make sure that all of the subsurface features and properties pertinent to design have been addressed.

## 6.10 References

ASTM (2000). Test Method for Performing Electronic Friction Cone and Piezocone Penetration Testing of Soils. D5778-20. West Conshohocken, PA: ASTM International, approved June 1, 2020.

ASTM (2016). Standard Test method for Energy Measurement for Dynamic Penetrometers. D4633-16. West Conshohocken, PA: ASTM International, D4633-16.

ASTM (2017). Standard Guide for Selection of Aquifer Test Method in Determining Hydraulic Properties by Well Techniques. D4043-17. West Conshohocken, PA: ASTM International, D4043-17.

ASTM (2018). Standard Test Method for Mechanical Cone Penetration Testing of Soils. D3441-16. West Conshohocken, PA: ASTM International, approved February 1, 2018.

ASTM (2019a). Standard Test methods for Downhole Seismic Testing. D7400-19. West Conshohocken, PA: ASTM International, D7400-19.

Hoek, E. and E. Brown (2019). "The Hoek–Brown failure criterion and GSI–2018 edition." Journal of Rock Mechanics and Geotechnical Engineering **11**(3): 445-463.

Loehr, J. E., A. Lutenecker, B. L. Rosenblad, A. Boeckmann and P. Brinckerhoff (2016). Geotechnical Site Characterization Geotechnical Engineering Circular No. 5, National Highway Institute (US).

Mayne, P. W., B. R. Christopher and J. DeJong (2002). Subsurface Investigations--Geotechnical Site Characterization: Reference Manual, United States. Federal Highway Administration.

Officials, A. A. o. S. H. a. T. (2020). AASHTO LRFD Bridge Design Specifications, 9th Edition. Washington, DC: AASHTO,

Youd, T. L. and S. K. Noble (1997). Magnitude scaling factors. Proc., NCEER Workshop on Evaluation of Liquefaction Resistance of Soils, Nat. Ctr. for Earthquake Engrg. Res., State Univ. of New York at Buffalo.



# Chapter 7 - Slope Stability Analysis



## Chapter Contents

<b>Chapter 7 - Slope Stability Analysis.....</b>	<b>7-1</b>
7.1 General.....	7-3
7.2 Limit Equilibrium .....	7-3
7.2.1 Drained vs Undrained Analysis.....	7-5
7.3 Geotechnical Design Parameters for Slope Stability Analysis.....	7-7
7.3.1 Soil Distribution and Cross Section .....	7-8
7.3.2 Pore Pressure, Seepage, and Groundwater .....	7-8
7.3.3 Shear Strength.....	7-10
7.3.4 Seismic Loads.....	7-14
7.4 Reliability and Resistance and Safety Factors for Slope Stability Analysis .....	7-14
7.5 Specialized Analyses .....	7-15
7.5.1 Back Calculation.....	7-15
7.5.2 Tension Cracks.....	7-16
7.5.3 Embankments on Weak Foundations .....	7-16
7.5.4 Analysis of Colluvium.....	7-16
7.6 Results of Computerized Analysis .....	7-17
7.7 References .....	7-18

**List Of Tables**

---

Table 7-1 Table Slope Stability Methods, Details and Assumptions ..... 7-4  
Table 7-2 Shear Strengths, Drainage Condition, Pore Pressure and Unit Weights for Slope  
Stability Analysis (FHWA-NHI-05-123)..... 7-7  
Table 7-3 Minimum Required Factors of Safety and Maximum Required Resistance Factors for  
Slope Stability Analyses ..... 7-14

**List Of Equations**

---

Equation 7-1 ..... 7-5  
Equation 7-2 ..... 7-10

## 7.1 General

Slope stability analysis is used for typical geotechnical design tasks, including, but not limited to, the following:

- Design maximum inclinations of permanent cut and fill slopes;
- Design of temporary excavations and shoring systems;
- Design stability and bearing capacity of embankments supported on weak, soft foundation soils for staged-construction;
- Design global and compound stability of retaining walls; and
- Assess forces and deformations of bridge deep foundations from effects of seismic liquefaction/lateral spread and potentially unstable slopes.

Stability analysis techniques specific to rock slopes, are described in [Chapter 11](#). Application of stability assessment in the analysis of landslides is described in [Chapter 13](#).

Embankments that do not support structures and/or side slopes of 2H:1V or flatter would typically not require a project-specific slope stability evaluation. Exceptions would include embankments constructed from highly plastic soils, soft subgrade conditions (i.e. deep organics, peat, diatomaceous soils, etc.), slopes subject to inundation, or other cases where, in the designer's judgement, analysis is warranted.

For cut slopes, excavations at 2H:1V or flatter in uniform native soils would also typically not require site-specific evaluation. Layered formations, overconsolidated clay soils, and colluvium (landslide debris) would be notable exceptions.

## 7.2 Limit Equilibrium

Slope stability design should be consistent with state-of-the-practice design guidelines, including, but not limited to, the referenced publications in [Chapter 7](#). Slope stability design shall be evaluated using conventional limit equilibrium methods and analyses should be performed using a state-of-the-practice slope stability computer program such as the most current versions of Slope/W® (Geo-Slope International), Slide® (Rocscience, Inc.), and/or ReSSA® (ADAMA Engineering, Inc.).

Limit equilibrium analysis procedures calculate the soil shear strengths that are at equilibrium with the applied soil shear stresses. In other words, the strengths that, if present, would result in a slope balanced between failure and stability. The relative stability of the slope is represented by the ratio of actual shear strengths to the equilibrium shear strengths (that ratio being the factor of safety).

Limit equilibrium analyses for the purposes of slope stability generally consist of splitting the soil mass into a series of vertical slices that can be analyzed in statics. The numerical solutions to these problems are statically indeterminate as there are more unknowns than the number of available equations. To resolve this, assumptions must be made to reduce the number of unknowns. Most methods make assumptions with respect to the magnitude and ratio of interslice shear and normal forces. Perhaps of more consequence, the methods vary with respect to whether they satisfy both moment and force equilibrium or merely force equilibrium.

Methods that meet both force and moment equilibrium generally are more rigorous and preferred.

Geotechnical Engineers and Engineering Geologists completing slope stability calculations should be familiar with the assumptions and limitations of the methods selected. In the case of more complex analyses it is necessary to compare the results of multiple methods. The following table summarizes the methods typically included in slope stability software packages.

**Table 7-1 Table Slope Stability Methods, Details and Assumptions**

Method	Force Equilibrium	Moment Equilibrium	Assumptions
Ordinary or Fellenius		X	The slip surface is circular and the forces on the sides of the slices are neglected.
Bishop's simplified		X	The slip surface is circular and the forces on the sides of the slices are horizontal (no shear)
Janbu's simplified	X		The inclinations of the interslice forces are assumed
Spencer	X	X	Interslice forces are parallel and the position of the normal force on the base of the slice is assumed
Morgenstern-Price	X	X	Interslice shear force is related to interslice normal force by $X = \lambda f(x)E$ and the position of the normal force on the base of the slice is assumed
Corps of Engineers	X		The inclinations of the interslice forces are assumed
Lowe-Karafiath	X		The inclinations of the interslice forces are assumed
Sarma	X	X	Interslice shear force is related to the available interslice shear force, interslice shear strength depends on shear strength parameters, pore water pressures, and the horizontal component

As noted in the preceding table, limit equilibrium methods vary significantly with respect to the assumptions included and the limitations therein. Although all of the methods cited are technically valid, the use of methods that satisfy both force and moment equilibrium is more rigorous and would generally be preferred. A thorough analysis would include using at least two analysis methods to evaluate whether or not a particular analysis is overly biased by the method's assumptions.

For complex projects it is prudent to use more complex modeling, such as three dimensional methods or finite difference methods, including the use of the computer programs such as FLAC. The complexities of such modeling make verification difficult. Complex analyses should be backed up with a parallel analysis using traditional methods to check that the results are broadly consistent with conventional analysis.

As noted in the documentation for Slope/W and most other slope stability software, a shallow face failure may be the controlling mechanism for a cohesionless slope. Frequently, that failure mechanism is precluded in reality by the localized cohesive nature of developed vegetation. Under those circumstances, the application of modest cohesion in the outer soils of the slope may be necessary.

## 7.2.1 Drained vs Undrained Analysis

The decision to select drained and/or undrained analyses requires knowledge of the loading regime, groundwater, seepage conditions, and soil permeability (as represented by consolidation characteristics). Frequently, short term stability analyses are said to utilize undrained strengths while long term stability analyses are said to utilize drained parameters. While broadly true, the actual issue is more complex.

An undrained analysis assumes that the analyzed load is applied faster than the excess pore water pressures can dissipate. Therefore, the presence of undrained conditions is heavily influenced by the nature of the soils and the drainage regime.

For saturated soils, the amount of time necessary to achieve a drained condition is governed by the following equation:

Equation 7-1

$$t_{99} = 4 \frac{D^2}{c_v}$$

Where  $t_{99}$  is the time required to reach 99 percent dissipation of excess porewater pressures,  $D$  is the length of the drainage path, and  $c_v$  is the coefficient of consolidation. For sand and gravels, the value of  $c_v$  would generally be in excess of 100,000 ft<sup>2</sup>/yr. As such, for granular soils the majority of loading conditions would be drained (rapid drawdown being a notable exception). For fine grained soils, the consolidation characteristics and drainage path length could be such that undrained conditions will exist for years after the new load is placed. However, fine

grained soils with short drainage paths or in an unsaturated state could reach a drained condition during the placement of the load (as with a large, slow-progress embankment constructed on unsaturated silts).

The following table derived from FHWA (2005) summarizes the soil parameters typically used for analysis conditions.

**Table 7-2 Shear Strengths, Drainage Condition, Pore Pressure and Unit Weights for Slope Stability Analysis (FHWA-NHI-05-123).**

	Condition		
	Undrained/End of Construction	Intermediate/Multi-Stage Loading	Drained/Longterm
Analysis procedure and shear strength for free draining soils	Effective stress analysis, using $c'$ and $\Phi'$	Effective stress analysis, using $c'$ and $\Phi'$	Effective stress analysis, using $c'$ and $\Phi'$
Analysis procedure and shear strength for impermeable soils	Total stress analysis, using $c$ and $\Phi$ from in situ, UU, or CU tests	Total stress analysis, using $c_u$ from CU tests and estimate of consolidation pressure	Effective stress analysis, using $c'$ and $\Phi'$
Internal pore pressures	For total stress analysis, no internal pore pressure, set $\mu$ equal to zero.	For total stress analysis, no internal pore pressure, set $\mu$ equal to zero.	$\mu$ from seepage analyses
	For effective stress analysis, $\mu$ from seepage analyses	For effective stress analysis, $\mu$ from seepage analyses	
External water pressures	Include	Include	Include
Unit Weights	Total	Total	Total
<p>Note: Multi-stage loading includes stage construction, rapid drawdown, and any other condition where a period of consolidation under one set of loads is followed by a change in load under undrained condition.</p>			

## 7.3 Geotechnical Design Parameters for Slope Stability Analysis

Geotechnical soil and rock design parameters are required for slope stability analysis with strength parameters developed using methodologies presented in [Chapter 6](#) and the other referenced publications in [Chapter 7](#). Slope stability analysis should consider the cases of short-

term and long-term stability using appropriate soil strength parameters, groundwater, and piezometric levels.

### 7.3.1 Soil Distribution and Cross Section

The goal of geologic research is to inform and develop a model of subsurface conditions that will influence the project. The data collected to develop the model comes from, site reconnaissance, subsurface exploration, laboratory testing, and site monitoring. For the purpose of slope stability evaluation, the overall site model will ultimately need to be summarized into a series of two dimensional cross sections. The development of stability cross sections often requires significant levels of professional judgement. In addition to standard QC review, it is advantageous to involve multiple professionals for a rigorous interpretation.

It should be noted that the stability cross section and the geologic cross section may be different. The stability cross section is intended to show zones of material that will exhibit similar broad responses to stress and strain. Fine detail and differentiation that may be appropriate for a geologic cross section may be overly complex for stability modeling. Conversely, it may be advantageous to split geologic formations into layering or zones that will behave differently under stress and strain but may be of one geologic origin.

Stability cross sections should be based on careful review of all of the data available to the designer. Further, the layout of the cross section should be iterative as the analysis progresses. The sensitivity of the model to assumed material transitions should be evaluated since sometimes moving a material boundary as little as six inches can have a significant impact on the analysis results. As the analysis develops, the designer should be looking for critical features and parameters that control the results. For example, if the critical failure surfaces tend to converge on a single location, the topography and shear strength in that location should be evaluated for conformity to the overall model.

With respect to tilted or sloping layers, a variety of approaches are available for analysis of this condition. One approach would be to create a series of layers that roughly follow the mapped layering with interstitial weak layers. That approach implies a level of knowledge with respect to layering that may not exist. Alternatively, anisotropic strength values can be input for a single layer. The advantage of using anisotropic strength is that the sensitivity of the analysis to the angle of the anisotropy and the directional strength ratio can be easily evaluated and can be varied in a statistical analysis.

### 7.3.2 Pore Pressure, Seepage, and Groundwater

Most slope failures are the result of reductions in effective stress associated with groundwater inundation and/or seepage. Detailed assessment of the pore water pressure and seepage regime within and beneath the slope is therefore critical in stability modeling.

Long term, multi season or year monitoring of piezometric data at multiple locations within the site represents the best opportunity for developing an accurate and representative model for pore pressures and seepage forces within the analyzed slope. Such data should be



supplemented with field observations of seeps, springs, surface inundation, as well as published data with respect to groundwater.

In reality, many small projects are of too limited a duration to allow for long term monitoring. When such data is not available, a conservative assumption with respect to the groundwater regime should be made, based on subsurface explorations, surface observations, and knowledge of local geology and hydrogeology.

Depending on the complexity of the seepage and groundwater regime, a detailed analysis either by hand with flow nets or using software such as Seep/W may be required. Such cases would include rapid drawdown (discussed in a subsequent subsection) and drains installed for landslide remediation.

### **7.3.2.1 Submerged Slopes**

Fully submerged slopes are relatively straightforward to analyze and are generally addressed using buoyant weights and total stress analysis. A completely submerged slope would be unlikely to be included in an ODOT project.

Much more common would be analysis of partially submerged slopes. Examples of partially submerged slopes would include roadway embankments that toe out in bodies of water such as lakes and rivers or pond slopes for stormwater facilities. The choices for analyzing the submerged portion are to use total weights with applied surface water forces or buoyant weights with seepage forces. Merely using buoyant weights for the portions below the water surface, or defining a water surface in space ignores the buttressing effect of the free water. The standing water should be modeled as a normal force derived from hydrostatic pressures.

### **7.3.2.2 Rapid Drawdown**

Rapid drawdown is a case where the water level adjacent to the slope lowers at a rate faster than the hydrostatic pressures can equilibrate through seepage. This condition can occur on the slopes adjacent to a reservoir, river, or canal following a long period of rainfall accumulation, planned lowering of water through control structures, or failure of water impoundment structure. Rapid drawdown is most prevalent in clayey slopes in which the excess pore water pressures do not dissipate as the water recedes, thereby keeping the overall shear strength low.

As with any stability case, an analysis using effective stress techniques coupled with in-depth knowledge of porewater and seepage pressures can be completed. Development of such a model for a rapid drawdown case would require a seepage analysis of a draining slope. Although hand calculation methods exist, it would generally be preferable to use computerized models such as Seep/W, with the results exported to Slope/W for the stability calculations.

Rapid drawdown is discussed in detail in the US Army Corps of Engineers Slope Stability Manual (2003). That document summarizes the original 1970 Corps of Engineers method that requires two sets of stability analyses. The first analysis is based on the conditions present just before the drawdown. That analysis determines the consolidation effective stresses to which the soils have been subjected. The effective stress results from the first analysis are used in the second analysis to estimate the undrained shear strengths that would exist during rapid

drawdown. The reported factor of safety for the analysis is derived from the second analysis. This method is generally overly conservative and is not in broad use today.

Also described in the Corps of Engineers manual and incorporated into Slope/w is the methodology presented by Duncan, Wright, and Wong in 1970. That methodology incorporates a three stage analysis.

As with the original Corps of Engineers method, the first stage involves the analysis of the embankment before drawdown to develop undrained shear strengths. The method adds a second stage after drawdown. The drained and undrained strengths along the slip surface resulting from the second stage are compared, and the lower of the two are used in the third stage. The third stage involves the stability analysis using the computed shear strength and the final drawdown water level. The computed factor of safety from the third stage is used to represent the overall analysis results.

### 7.3.3 Shear Strength

Shear strength is perhaps the most important parameter to determine when completing slope stability analysis. The most common model for shear strength is the Mohr-Coulomb strength envelope. In the most-simple terms, Mohr-Coulomb strength is modeled with the following equation:

Equation 7-2

$$s=c+\sigma\tan\phi$$

Where  $s$  is the shear strength,  $c$  is the cohesion intercept,  $\sigma$  is the normal stress on the failure plane at failure, and  $\phi$  is the angle of internal friction. The form of the Mohr-Coulomb strength envelope implies that the strength relationship is linear with respect to stress on the shear plane. In reality, the envelope is typically curved, with higher levels of curvature at lower confining pressures. If detailed strength data exists, the curved strength envelope can be directly entered into slope stability software and would be preferential to a straight line fit.

The development of shear strength values for use in stability modeling is a complex subject. Professionals completing stability modeling should be knowledgeable with respect to the limitations and risks associated with selecting strength parameters for use. Detailed information on this subject is included in a number of the references, in particular Duncan (2015).

Ideally, shear strength values used in analysis would be derived from laboratory testing completed on appropriate samples collected at the site. However, appropriate samples for testing may not be available for all projects. Further, for new construction, the actual material to be placed in the embankments may not be known and the designer may have to rely on available specifications to assume the range of material that may be used in constructing embankments.

Shear strength values can be obtained from a variety of sources ranging from assumed values based on knowledge of the regional geology to data resulting from complex testing of soil

samples. The level of detail used in obtaining shear strengths should be consistent with the complexity and risk associated with the analyzed slope.

Typically, the shear strength of fine grained soils is determined based upon laboratory testing or back calculation analysis. Empirical correlations between field data and shear strength are limited to granular cohesionless soils. As noted in Peck, Hanson, and Thornburn, “The correlation (between strength and spt values) for clays can be regarded as no more than a crude approximation, but that for sands is often reliable enough to permit the use of N-values in foundation design.” The same would be true for stability evaluation.

Prior to conducting laboratory testing, the nature of the analysis (drained, undrained, or both) must be established based on a knowledge of the loading regime and the behavior of the soil under load. Development of undrained and drained strength parameters, including a brief discussion of the test methods available, is presented below. Detailed information is included in a number of the references, in particular Duncan (2015).

### **7.3.3.1 Drained Strength**

Laboratory tests available to assist in developing drained strength parameters include Consolidated Drained (CD) triaxial test and direct shear test. Sample disturbance is an issue with undrained tests, particularly with samples that are not consolidated prior to testing.

#### **Consolidated-Drained (CD) Triaxial Test**

For Consolidated Drained tests, the sample is consolidated prior to application of deviator stresses. The deviator stresses are applied slowly to allow pore pressures built up by the shearing to dissipate. The test is strain-controlled and the rate of axial deformation is kept constant. Depending on the nature of the sample, CD tests can take a long time to complete in order to allow for the dissipation of excess porewater pressures.

#### **Direct Shear Test**

The Direct Shear test is the simplest form of shear test. The sample is placed in a metal shear box and is confined by a vertical stress. A horizontal force is applied to half of the sample and the sample fails by shearing along a defined plane. The test can be either be stress-controlled or strain-controlled. Typically the test is operated slowly enough to measure consolidated-drained conditions.

In order to evaluate larger strains associated with residual shear, torsional Direct Shear tests have been developed.

### **7.3.3.2 Undrained Strength**

Laboratory tests available to assist in developing undrained strength parameters include Unconsolidated Undrained (UU) and Consolidated Undrained (CU) triaxial tests, unconfined compression tests, and direct simple shear tests. Sample disturbance is an issue with undrained tests, particularly with samples that are not consolidated prior to testing.

#### **Unconsolidated–Undrained (UU) Triaxial Test**

For an Unconsolidated Undrained (UU) test, no drainage is allowed during the application of confining pressure or shearing stress. Since there is no need to allow for drainage, the shearing stresses are applied relatively quickly. It is important that the moisture content of the soils during testing be consistent with field conditions.

The test results are presented in terms of total stresses and the results are used in total stress analyses. This test represents the ideal condition with respect to undrained loading in the field and if completed on a truly undisturbed sample. However, sample disturbance and lack of consolidation after sampling results in significant disturbance impacts.

### **Consolidated–Undrained (CU) Triaxial Test**

Consolidated-Undrained test samples are allowed to drain during the consolidation stage. During this stage, the confining pressure is applied and the specimen is allowed to fully consolidate. Unlike the UU test, the sample is saturated, usually using back-pressure methods. When the consolidation stage is completed, the drainage system is closed to prevent further drainage. Typically, the porewater pressures are monitored and recorded during the shearing stage. Unlike the UU test, the shearing stresses are applied slowly in order to allow for the equalization of porewater pressures throughout the sample.

The results from CU tests are used for cases where sample disturbance is suspected or likely, for analysis of rapid drawdown, and in the analysis of staged embankment construction. And although a generally inferior test in terms of applicability of the results, CU tests are more common than CD tests owing to the significantly lower time needed to complete the test. For dealing with disturbed samples, the SHANSEP and recompression approaches are available to minimize the effects of disturbance on the test results.

### **Unconfined Compression Test**

The Unconfined Compression test is one of the fastest and least expensive methods of measuring shear strength. The method is only applicable to cohesive samples taken from undisturbed (thin wall) sampling. The sample is typically trimmed into a cylinder after extrusion. The ratio of length to diameter is between 2 and 2.5. The sample is tested in compression without confinement. The unconfined compressive strength ( $q_u$ ) is the lesser of the maximum stress attained, or the stress at 15% axial strain. After testing, the sample is oven dried to determine its water content. The test is operated at speeds consistent with the assumption of drained loading. Porewater pressures are unknown during the test meaning that the effective strength cannot be determined. As such, the unconfined compressive strength is a total stress value, applicable to undrained analyses.

### **Direct Simple Shear Test**

The Simple Shear test was developed in order to evaluate stress and strain within samples. The test creates a relatively homogeneous state of shear stress throughout the specimen, allowing for the evaluation of the stress path and sample deformation. This approach more closely models field conditions than the Direct Shear test but it less representative than triaxial testing.

### **Field Vane Shear Test**

The field vane shear test is very effective in measuring the undrained strength of soft clays at somewhat shallow depths. The test consists of pushing a four bladed vane into the bottom of a borehole, test pit, or hand excavation. The device measures the torque needed to rotate the vane which is correlated to shear stresses on the resulting sheared cylinder of soil.

### **7.3.3.3 Strength Correlations and Assumed Values**

Correlative approaches to developing undrained strengths include field vane shear, cpt, pressuremeter, dilatometer and SPT. Extensive correlations exist with respect to atterberg limit indices. As previously noted, estimating the strengths of cohesive soils from field measurements is generally discouraged. Exceptions would include fully softened and undrained strengths that may be reasonable to assume from atterburg limits tests and similar index tests.

AASHTO Section 10.4.6.2.4 contains direction with respect to estimating drained strengths of granular soils from SPT blowcounts.

### **7.3.3.4 Overconsolidated Clays**

Strength loss in stiff clays exposed in excavations is well documented in literature and has been the cause of a number of the larger landslides impacting roadways in the Pacific Northwest. When subjected to deformation or changes in stress, the shear strength of stiff clays can drop from the initial undisturbed strength to values approaching the fully softened shear strength. This also occurs in embankments constructed from plastic clays, although the strength loss is generally limited to the outer 10 feet of the embankment face.

### **7.3.3.5 Cohesion**

A parametric and/or statistical review of slope stability analyses results in the knowledge that even small values of cohesion can have a significant impact on the results. As such, the use of cohesion in slope stability modeling requires great care. Cohesion is not a property that should be assumed but rather, the cohesion intercept should be based on a significant and appropriate laboratory testing program. An exception would be the assumption of modest levels of cohesion for the outer one to three feet of vegetated slopes, used to model the impact of vegetation in resisting shallow failures. Use of such a model should be applied cautiously.

Actual, rather than apparent, cohesion is present in soils due to cementation and/or electrostatic forces in clays associated with overconsolidation. Apparent cohesion is generally caused by suction or capillary forces in unsaturated soils.

Cohesion associated with cementation can potentially be relied on in design although cemented soils subject to changes in seepage, saturation, and stress may be subject to reductions in cementation and cohesion.

Whether or not the cohesion derives from cementation or overconsolidation, soils subjected to past movement, for which the shear planes are fully developed, are governed by residual shear and generally do not exhibit cohesion.

Therefore, the use of cohesion in the analysis of slope stability for highway cuts, embankments, and retaining walls should be limited to sites where laboratory tests document the cohesion and

where the presence of cementation and/or overconsolidation is consistent with the geology. Additionally, the geology needs to clearly document that past landslide movement associated with development of residual shear strengths can be categorically ruled out. Finally, for overconsolidated clays, the soils should not be fractured or displaced, subject to changes in stress, saturation, or seepage. The inclusion of a cohesion value for the stability of colluvium or ancient landslide debris is always inappropriate.

### 7.3.4 Seismic Loads

Stability analysis under seismic loads is discussed in detail in [Chapter 13](#).

## 7.4 Reliability and Resistance and Safety Factors for Slope Stability Analysis

For overall stability analysis of walls and structure foundations, design shall be consistent with [Chapter 7](#), [Chapter 15](#) and [Chapter 16](#) and the *AASHTO LRFD Bridge Design Specifications*. This section contains minimum factors of safety for use in ODOT projects. Whether or not higher factors of safety should be applied will need to be based on the Engineer's judgement with respect to the level of information available in completing the analysis and the risk that actual conditions will vary from those assumed.

The following table summarizes minimum factors of safety (and maximum LRFD resistance factors) for projects where sufficient information exists to adequately define soil profile, slope geometry, soil shear strength and porewater pressure in the slope stability model:

**Table 7-3 Minimum Required Factors of Safety and Maximum Required Resistance Factors for Slope Stability Analyses**

Geotechnical Item Under Consideration	Minimum Factor of Safety	Maximum LRFD Resistance Factor	Notes
Slopes that Support Structures	1.5	0.65	AASHTO LRFD Bridge Design Specifications. Load Factor of 1.
Slopes adjacent to, but not supporting, structures	1.3	0.75	AASHTO LRFD Bridge Design Specifications. Load Factor of 1.

Geotechnical Item Under Consideration	Minimum Factor of Safety	Maximum LRFD Resistance Factor	Notes
Embankment Side Slopes	1.25		
Cut Slopes	1.25		
Landslide Remediation	1.25		

For cases where parameters are assumed, and/or information is unknown, higher safety factors than presented would be applicable. Generally, the use of factors of safety in excess of 1.5 is unnecessary.

## 7.5 Specialized Analyses

This section presents specifics with respect to a variety of analysis cases that are common in highway geotechnical work.

### 7.5.1 Back Calculation

Back Calculation allows for the development of soil strength based on the configuration of an existing slope failure. The information provided from this type of analysis is invaluable and allows for the development of in situ parameters that are difficult to obtain through exploration and testing. The methodology relies on the concept that a slope failure at initiation and/or at rest is in equilibrium (a factor of safety of 1.0). Working backward from a known factor of safety allows for the slope to be modeled at the time that it failed.

The premise of back calculation is that a moving, or imminently moving, landslide is at a factor of safety of 1.0. In other words, as long as the material is moving but not accelerating, the forces that restrain movement must be in balance with the forces creating movement (equilibrium). A slope that hasn't failed is difficult to evaluate with respect to back calculation.

It is important to note that a number of combinations of soil strength distribution and pore water pressure regime can result in the same 1.0 back calculated factor of safety. As such, any one solution might not be the "true" condition at failure. However, research has indicated that if the ranges of values and conditions used are broadly reasonable, then the model can be used to develop remedial schemes with the post-remediation factors of safety also being broadly reasonable. For this reason, back calculation is extremely valuable in developing landslide remedial schemes. This is particularly true to the extent that back calculated conditions can be verified through field and laboratory data.

One item that is crucial to have as accurate as possible in back calculation is the location of the shear plane. Ideally, this is evaluated through direct monitoring of inclinometers. For landslides that are not currently moving, detailed explorations may identify past slip zones through the identification of soft soils, slickensides, or material layering.

The strength and porewater pressure values developed in the back calculation analysis may require modification for analysis of the post repair or modification case. For example, the landslide may disrupt drainage patterns and seepage in ways that should be accounted for in the subsequent model. Frequently, in order to make the initiation of a landslide work in back calculation, a cohesion intercept must be applied. Care should be taken to only apply cohesion to materials where the existence can be reasonably surmised, including apparent cohesion. However, in evaluating the stability of a repaired or modified slope, the continued use of cohesion should be associated with careful review, as discussed in [Chapter 7](#).

## 7.5.2 Tension Cracks

When modeling existing or impending landslides, open cracks may be observed in the field. These cracks represent a significant modification to the section and are important to include in the model. Further, with cohesive soils, the slide forces may document the existence of tensile stresses in the upper portions of the slope. Since soils generally can't develop tensile forces, it is necessary to insert a crack in the analysis, negating the tension.

## 7.5.3 Embankments on Weak Foundations

Embankments on weak foundation soils **may** require detailed analyses. Frequently, the project design must be modified to address situations where the undrained strengths of the foundation soils are insufficient to support the proposed embankment slopes. Techniques to address this situation include placing the embankment slowly to allow excess porewater pressures to dissipate and the installation of vertical drains to shorten drainage times. Alternately, the embankment slopes can be flattened or reinforced.

One concern to address is the strain compatibility between the compacted embankment and the underlying structure. For weak foundation conditions, the compacted embankment will typically be much stiffer than the underlying soils. This issue is particularly acute with respect to cohesive soils used in constructing the embankment. In completing the short-term, undrained analysis for such a situation, the embankment should be modeled with a tension crack.

## 7.5.4 Analysis of Colluvium

Colluvium and ancient **and active** landslides are present throughout Oregon and can be identified by subsurface explorations or interpretation of surface topography. Although the landslide may have occurred more than 10,000 years ago, it is feasible that soils within the mass of the landslide will continue to behave as though the slide was more recent. In particular, with respect to shear strengths approaching residual shear levels. Even though no evidence of past shear planes or slickensides may be evident through the exploration program, colluvium is generally assumed to contain such features and they should be assumed to be present in any subsequent stability assessments. **Analysis of proposed grading within a colluvial deposit**



requires an extra level of care, consistent with the risks associated with the potential to reactivate landslide movement.

## 7.6 Results of Computerized Analysis

As with all engineering analysis, thorough review and QA is necessary to assure that the project details have been accurately captured and to verify that the software executed without error.

1. It is important to have the slope stability analysis completed without errors. Analyses that document the presence of errors should be modified and rerun until those errors are eliminated. It is not reasonable to assume that the source of error is known and the consequences of those errors is understood.
2. Assuming that the software executed without error, the next step would be to verify that the factors of safety are reasonable. Factors of safety of less than 1.0, including negative values, are indicative of the need to make adjustments in soil strengths, project geometry, etc.
3. Next, the designer should review the most critical failure surfaces. All failure surfaces at or near the minimum, or critical, surface should reflect conditions that are physically possible. Sharp angles in failure planes, particularly near the toe, may unreasonably influence the factor of safety. This is especially problematic for defined block analyses.

For presentation, the analysis cross sections should be presented to scale, with or without an expanded scale in the vertical dimension, as needed for clarity. Typically, the family of failure surfaces developed by the software would be plotted with a heavier line representing the critical failure surface. The presentation of the model should clearly identify the soil regions and the soil parameters applied to each region. The input and output of the slope stability models are required in the Appendices of the Geotechnical Reporting Document.

## 7.7 References

- Duncan, J.M., et al, 2015, John Wiley & Sons, Inc., Soil Strength and Slope Stability, Second Edition
- Duncan, J.M., Wright S.G., and Wong, K.S., 1990, American Society of Civil Engineers, "Slope Stability during Rapid Drawdown", Proceedings of H. Bolton Seed Memorial Symposium. Vol. 2.
- Corps of Engineers (2003) Department of the U.S Army Corps of Engineers. Slope Stability, Engineering Manual, EM 1110-2-1902
- Turner, A.K. and Schuster, R.L., 1996, Transportation Research Board, National Research Council, Landslides investigation and Mitigation, Special Report 247,
- Collin, J.G., et al, 2005, U.S. Department of Transportation, Federal Highway Administration, Soil Slope and Embankment Design Reference Manual, FHWA-NHI-05-123.
- Samtani, N.C. and Nowatzki, E. A., 2006, U.S. Department of Transportation, Federal Highway Administration, Soils and Foundations Reference Manual, FHWA-NHI-06-088.
- Loehr, J.E., et al, 2016 U.S. Department of Transportation, Federal Highway Administration, Geotechnical Site Characterization, Geotechnical Engineering Circular No. 5, FHWA-NHI-16-072.
- Sabatini, P.J., Bachus, R.C., Mayne, P.W., Schneider, J.A., and Zettler, T.E., 2002. "Geotechnical Engineering Circular No. 5, Evaluation of Soil and Rock Properties", Report No. FHWA-IF-02-034, U.S. Department of Transportation, Federal Highway Administration, Washington, D.C.

# Chapter 8 - Material Source



## Chapter Contents

<b>Chapter 8 - Material Source</b> .....	<b>8-1</b>
8.1 General.....	8-3
8.2 Material Source and Disposal Site Definitions.....	8-3
8.3 Material Source and Disposal Site Project Scoping.....	8-4
8.4 Material Source and Disposal Site Project Reconnaissance .....	8-5
8.5 Right-of-Way Needs for Material and Disposal Sites .....	8-6
8.6 Environmental Clearances for Material Sources and Disposal Sites .....	8-7
8.7 Material Source and Disposal Site Investigation.....	8-8
8.8 Material Source and Disposal Site Sampling and Testing.....	8-9
8.8.1 Sampling.....	8-9
8.8.2 Testing.....	8-10
8.9 Material Source and Disposal Site Exploration Logging.....	8-11
8.10 Material Source and Disposal Site Mapping.....	8-12
8.11 Design and Development of Material Sources and Disposal Sites .....	8-13
8.11.1 Material Sources and Disposal Sites Slope Design.....	8-13
8.11.2 Material Sources and Disposal Sites Designed Safety Elements .....	8-14
8.12 Drafting of Material Source and Disposal Site Development Plans .....	8-15
8.13 Material Source and Disposal Site Operational Specifications.....	8-15
8.14 Material Source and Disposal Site Quantity Calculations .....	8-15
8.15 Reclamation of Material Sources and Disposal Sites .....	8-17
8.16 Material Source Blasting .....	8-17
8.17 Material Source and Disposal Site Erosion Control .....	8-18

8.18 Material Source and Disposal Site Permitting ..... 8-18  
8.19 Material Source and Disposal Site Visual Concerns ..... 8-19  
8.20 Material Source and Disposal Site Narrative Reports ..... 8-19  
8.21 Material Sources and Disposal Sites and Construction ..... 8-21  
8.22 Material Source Numbering ..... 8-21  
8.23 Asset Management for Material Sources: Inventory, Evaluate and Record ..... 8-22  
8.24 References ..... 8-24

## 8.1 General

This chapter discusses the purpose for Oregon Department of Transportation (ODOT) disposal site and material source exploration and design. Identification, design, development, and permitting of material sources and disposal sites require nearly all the same elements that go into a large transportation project. Material sources and disposal sites require identification, investigation, environmental review, mining and land use permitting, right-of-way acquisition and/or delineation, topographic survey, CAD design, and reclamation.

Time lines associated with various tasks that go into site and source exploration, development, and reclamation generally do not follow along with project time lines associated with similar tasks (e.g., surveying and environmental surveys). In general, many of these tasks need to be completed for sources and disposal sites, in advance of when they would be scheduled for the project that the source(s) or disposal site(s) will be associated with.

Disposal sites and material sources are investigated and designed in conjunction with construction and maintenance of the transportation facilities.

- **Material source investigation:** The purpose of a material source investigation is to identify and prove out sufficient quantities of material meeting the quality requirements for the intended use.
- **Design:** The purpose of the design is to graphically represent the proposed development of the material source or disposal site in the contract plan sheets taking into account the property limits, site conditions, permitting requirements, most efficient extraction, current need, and future use of the source and/or site. Detailed design and reclamation plans are also requirements for the permitting of material sources.

Throughout this chapter, various guidance documents and forms are identified and referenced. Document names will be shown in italicized font. Information that hyperlinks to other information such as tables, figures, other documents, forms, or URLs will be displayed underlined and in bold. In other sections, there are references made to available information. These specific documents and referenced material can be found on the ODOT [Geology/Geotechnical](#) website.

## 8.2 Material Source and Disposal Site Definitions

The following definitions and terms are used in this chapter.

**ODOT Material Source** - A unique parcel or combination of parcels of land that are ODOT owned or controlled, specifically identified as the location from which material can be removed for utilization in the construction of a highway project and the continued maintenance of the transportation facility. Material from an ODOT source may or may not require secondary processing prior to incorporation into a project.

**ODOT Disposal Site** - A unique parcel or combination of parcels of land that are ODOT owned or controlled, specifically identified as the location where excess clean fill from a highway construction project, or generated through routine or emergency maintenance activities, can be

temporarily stockpiled for future beneficial use or permanently placed as a secondary beneficial use.

**Note:**

*Placement of material without a beneficial use equates to the creation of a landfill requiring permitting through DEQ.*

**Material** - Material can either be in-place, naturally occurring earthen material (soil, cinder, hard rock, or gravel) or earthen material that has been transported to this location from another site or sites and stockpiled for future use. In some situations, the term “material” can be used to refer to recycled material such as pavement grindings.

**Clean Fill** - Rock, soil, concrete with or without rebar (provided the rebar is not exposed), brick, building block, tile, or asphalt paving (weathered and consolidated with no free oil) that does not contain contaminants that could adversely impact waters of the state or public health. Wood is not considered clean fill.

**Highway Shoulder Soil** – Potentially contaminated soil from highway use outside the current highway pavement and within highway right of way. DEQ Beneficial Use Determination ([BUD-20181204](#)) categorizes shoulder soil by physiographic province, lateral distance for the edge of pavement (30 ft. max.), and vertical distance from the ground surface (1.5 ft. max.). Reference the BUD for approved beneficial uses by physiographic province, distance from pavement, and excavation depths.

**Quarry** - A term generally used to refer to a hard rock source that commonly will require blasting techniques to be utilized prior to extraction of the native material. In Oregon, this term is commonly associated with quarry operations located in igneous flow deposits.

**Pit** - A term used to refer to a mine site that generally does not require blasting prior to extraction, and is commonly associated with gravel, cinder, or soil sources.

**Source/Site Designer** - In the context of this discussion, the Source/Site designer is defined as the Certified Engineering Geologist (C.E.G) who ultimately will be the Professional of Record (POR) for the material source and/or disposal site design.

## 8.3 Material Source and Disposal Site Project Scoping

Project scoping is a key element of any project to assure a quality transportation solution and subsequently an efficient and economical design. Scoping related to material sources and disposal sites is critical at an early stage in the project development. As implied above, material sources and disposal site development should be viewed as small projects inside the larger transportation project. If the need for a source and/or disposal site and the subsequent identification of the site is not completed early in the process, there may be inadequate time and project funding to complete the required work tasks (especially if there is right-of-way acquisition, significant environmental requirements, or permitting requirements.).

In the scoping phase of a project, it should be determined if there will be materials needed for the project. If the proposed project will need material, consider the following:

- **Estimate material quantity needed:** An estimated quantity of the various types of material should be developed.
- **Evaluate:** Evaluation of the project and the availability of the various material products needed should then be undertaken to determine what options are available to meet these project needs. It should be determined if the project needs can be met by utilizing material coming from the project or if material will need to be imported. If project quantities or quality are determined to be insufficient to meet the project needs, and material will be imported, it will need to be determined what the options are for meeting these needs: existing commercial suppliers, private sources, other ODOT projects, ODOT controlled material sources or a combination of these sources of material. ODOT has developed guidance documents to assist in determining the potential need for a material source and/or a disposal site titled [Material Source Use Criteria](#), ODOT Material Source Management, Uses, and Associated Costs, Justification for Offering ODOT Material Sources, and Prospective versus Mandatory.

The same process should be followed in regards to disposal sites for excess materials generated on a project. The potential need for a publicly controlled disposal site for placement of excess materials should be evaluated using the above mentioned guidance document.

[PD-10, Project Delivery Leadership Team Operational Notice - 10](#), provides additional guidance as to when a publicly controlled disposal site may be needed for a project. The [Geo-Environmental Bulletin GE08-04\(B\), Designating Construction Staging, and Disposal Sites](#) document also provides additional information on this issue. [The ODOT HazMat Program Manual](#) (Section 6.0) provides guidance on clean fill determinations and shoulder soil beneficial use determination.

## 8.4 Material Source and Disposal Site Project Reconnaissance

If it has been determined during, the project scoping phase that a publicly controlled source of materials and/or a publicly controlled disposal site or both are needed, existing sources and properties will need to be evaluated. ODOT has developed guidance documents that generally outline the steps necessary for disposal site and for source development titled, [ODOT Material Source Checklist](#) and [Disposal Site Checklist](#).

Evaluate existing database and file information to determine the existence of sources in the area and to identify those sites that may meet the project needs for both quantity and quality of material. Consider the following:

- **Additional information:** Information related to survey data, land use zoning, ownership, environmental clearances, visual restrictions, land use, and permits should also be reviewed. If the project is in need of a publicly controlled material source and no existing sources appear able to meet the demand, it is at this point that new or

alternative sources of material would be considered and additional reconnaissance be completed.

- When evaluating potential sources, a useful tool has been developed by ODOT to assist in gathering needed information. This tool is titled [Material Source Field Inventory](#).
- **Notifications:** If the proposed source or site is located near residential development or other potentially sensitive land use or environmental areas, it may be necessary to notify local property owners or groups of proposed activities in advance of onsite work beginning. ODOT has developed a template that can be modified to fit the proposed activities that can be
- Completed and used to notify interested parties in an effort to inform them of what is being proposed and in an attempt to eliminate unrealistic fear and objections related to misunderstandings and misinformation. This template is titled [Material Source Public Communication Document](#).
- **Other Agency information:** Valuable information on sources and source availability in the area of interest can be obtained by contacting the Department of Geology and Mineral Industries, the United States Forest Service, Bureau of Land Management as well as County Road/Public Works Departments.
- **Cost:** Once a site or sites have been identified, the estimated cost for development will need to be compared with the anticipated value of the site to the project and future projects to determine a cost benefit evaluation prior to moving forward with the source development. ODOT has developed an internal tool to assist in estimating the cost of source or site development titled [Material Source Evaluation Form](#) (on the second tab of excel workbook). In most cases, ODOT does not charge a royalty for material removed from their sources when the source is being offered for the project at the time of bidding. The cost of development and the value of the rock are realized in competitive bidding and long-term material availability. The document [Royalties & ODOT Sources](#) provides additional information on this issue.

## 8.5 Right-of-Way Needs for Material and Disposal Sites

If it is determined additional property is required at material sources or disposal sites to meet the proposed project, it is critical that this need is identified during the scoping phase. Right-of-way acquisition takes time and when dealing with material source properties, it generally will require an extended timeline. Once the agreements or permits of entry allowing additional work to be completed are in hand, a detailed evaluation and investigation can move forward. An [Acquisition Guidance](#) document has been prepared to explain the general process.

If the evaluation and investigation does not identify any fatal flaws, the right-of-way acquisition or lease negotiations can be finalized. The normal time lines associated with project right-of-way acquisitions do not generally allow for the right-of-way work associated with a material source or disposal site to move forward on the same schedule.



**Note:**

*Right-of-way activities related to material sources and disposal sites generally need to start earlier than they would for the project to allow for adequate evaluation of sites and permitting.*

Due to permitting requirements associated with the mining or disposal activity, the right-of-way purchase or other occupancy agreement must be completed prior to moving forward with the permit process that generally starts at the preliminary plan phase of a project. The investigation work associated with the evaluation of the site or sites in advance of finalizing what property is needed and the subsequent permitting work combine to lengthen the normal right-of-way process and also force an earlier than normal start to this effort for project right-of-way work.

## **8.6 Environmental Clearances for Material Sources and Disposal Sites**

Material source and disposal site development, by nature of the activity, is a ground disturbing action. No source or disposal site development can take place without first obtaining all of the necessary environmental clearances required by state and federal law. ODOT projects must follow the federal standards instead of state requirements when obtaining environmental clearances due to frequent federal participation in the project funding. Even if the currently proposed project is not federally funded, ODOT still tries to meet federal standards related to material sources and disposal sites since the sources are long-term investments and will likely be used for federally funded projects in the future.

### **Investigation**

The investigation work for sources and disposal sites is considered invasive enough to require environmental clearances prior to the implementation of the investigation plans. As a result, it likely will be necessary to obtain preliminary, if not all, clearances for the investigation work. If there is a high level of confidence that the source contains the necessary material quality and quantity, it is a better use of the resources to environmentally clear the entire site for all activities at one time prior to the implementation of the investigation plan. If there is uncertainty or inadequate time to complete the environmental surveys for the entire site prior to investigation, it may be necessary to complete only the minimum amount of clearances required to conduct the investigation. If only partial clearances are obtained in the early stages, and the source or site is pursued for use, follow up comprehensive environmental work to survey and clear the entire area will be required.

In addition to the common environmental concerns related to archeological, historic, wetland and Threatened and Endangered Species resources, the issue of noxious weeds, invasive plants and migratory birds will need to be evaluated and addressed in all source and/or site related activities.

## 8.7 Material Source and Disposal Site Investigation

Investigation techniques that are common to geologic and geotechnical investigations are also used for materials sources. Common methods include test pits, auger borings, and wire-line core sampling. Air track drill investigations are often used independently or in conjunction with core hole explorations.

**Exploration methods:** Test pits and auger hole explorations are the most common form of investigation in sources of common soil, cinder and gravel deposits. Air track drill and wire-line core explorations are frequently used in investigating hard rock deposits. The selected method of investigation, and the number, location, and depth of holes or test pits planned and then completed will depend on the site and the existing information available on the site. When determining the method(s) to use in investigating the site, the proposed development strategy will also influence the method selected.

**Investigating material source sites:** When investigating material source sites, the investigation plan should be developed and carried out to identify the lateral and vertical extent of the deposit or deposits. Vertical and lateral variations in the deposits such as material type, gradation characteristics, coatings on the material, weathering, hardness, relative density, joint spacing, joint infilling, cementation, vesicularity, slaking, and other characteristics that may impact the development and/or material quality are important and should be noted on the logs. Overburden thicknesses, flow contacts, and existence of water are also critical elements that need to be noted.

**Air track drill investigations:** Air track drill investigations are ideal for gathering information rather inexpensively over a large area. This method of investigation can be useful in determining overburden depths, existence of rock and some basic rock characteristics, but should not be used as the sole source of information on most hard rock quarries. Air track drill information does not generally provide enough detail to fully understand potential material variations and does not provide samples sufficient for determining rock quality. In most cases, air track drill investigations are used to obtain basic and preliminary information and to identify areas requiring more detailed wire line exploration.

**Wire line core explorations:** Wire line core explorations provide the investigator the details necessary to adequately characterize the material and the various source and material characteristics that will influence the source development.

The Engineering Geologist working on the source development must use experience and professional judgment in determining the level and type of investigation necessary for the proposed source development. As a guide, there are several “rules of thumb” associated with source investigations. These guidelines are:

- Sites with limited history and or complex geology will generally require a higher level of investigation.

- New sites will generally require a much more detailed and comprehensive effort than an existing site with a long history of use with no associated problems.
- In general, the larger the proposed operation the larger and more detailed the investigation will likely be.
- As mentioned earlier, if a site has rather simple geology or well-defined geology and a long history of use and good information is available, the Engineering Geologist may decide not to complete additional subsurface investigation. If subsurface investigation is completed on a site, at least one, if not more, of the exploration locations should be focused on and completed within the proposed excavation area for the upcoming project. Planned material source development should not exceed the extent or depth of the investigation.
- Investigations conducted for disposal sources are generally carried out to investigate for foundation stability concerns (see [Chapter 3](#) for details). Coordination between the engineering geologist and the geotechnical engineer will be critical in the site evaluation and development of the investigation plan, if required.
- In most situations, it will be necessary to have some form of land use agreement or permit and environmental clearances completed in advance of doing any investigation work.

## **8.8 Material Source and Disposal Site Sampling and Testing**

The method of investigation and the sampling and testing program will be dependent on the site and proposed site use. For disposal sites, if sampling and testing is needed it will be associated with subsurface samples and testing associated with site stability evaluation. For material sources, the sampling and testing will be dependent on the site and the type of material that is needed for the project.

### **8.8.1 Sampling**

Samples from the proposed source development area can be obtained from surface exposures for preliminary qualification information when completing initial site assessment, or when no subsequent investigation will be completed. When obtaining surface samples from an existing site that has not been worked for many years, the sampler should create a fresh face from which to obtain a representative sample. Existing stockpiled material can also be sampled and tested to obtain quality information. If follow up investigation is completed in the area or areas of proposed development, representative qualification samples should be obtained and tested. Sampling and testing differing units or zones of material becomes more important and critical as the quality requirements become more stringent. A source of material proposed for use on a paving project will require a more detailed investigation and sampling and testing program than a source proposed for use as common borrow.

Depending on the intended use of the material, it may be necessary to employ specific sampling techniques to determine if the material or various material units will meet the project

requirements beyond simply the quality of the material. An example would be the need to sample a quarry site using coring equipment to determine the joint spacing of the material if the project needs are for rip rap of a specified size and the site has little to no history that would allow for adequate site characterization.

Sampling guidelines for produced aggregate material or existing stockpiles are provided in AASHTO T2 ([ASTM D 75](#)).

No matter what is being sampled, or where the sample is coming from, it is critical that the person collecting the sample collect a representative sample of the material at the site, not just selecting the best or worst material.

Required sample size can vary, but for surface samples or samples obtained from a subsurface investigation, the following is a general rule of thumb for sample size: **six canvas sample bags (50 lbs. each) of quarry rock** or **nine** bags of gravel (a 5 gallon bucket could substitute for one canvas bag) per sample/per site. The size of quarry rock should be 4 to 6 inches chunks, and material from a gravel pit should be the whole range of sizes with the maximum size a 6 inches cobble.

## 8.8.2 Testing

In the past, the ODOT lab would only test sources that were involved or proposed for use on an ODOT project, but now the ODOT lab will run source compliance tests for a source not currently being used for an ODOT project as long as an ODOT source number has been assigned to the source.

The results of these source compliance tests, no matter if run by the ODOT lab or a private lab, are viewed as: **INFORMATIONAL ONLY**. These "Informational" test results are intended to assist ODOT, contractors, consultants, or material suppliers in evaluating the quality of the aggregate potentially available in a particular source. No matter the outcome of these tests, this testing will not eliminate or reduce the need to sample and test produced material to assure compliance with project specifications.

The tests run for source compliance are normally the following:

- T84 (Fine Bulk Gravity)
- T85 (Coarse Bulk Gravity)
- T96 (Abrasion)
- T104 (Sodium Sulfate)
- T113 (Lightweight Pieces)
- T176 (Sand Equivalent)
- TM 208 (Sodium Sulfate)

In addition to these tests, ODOT also runs the following tests for informational purposes when the material may be used for MSE wall or gabion backfill or pipe bedding material:

- AASHTO T288 (Resistivity)
- AASHTO T289 (pH)
- AASHTO T291 (Chlorides)

- AASHTO T290 (Sulfates)
- AASHTO T267 (Organic content)

For gravel sources, ODOT also runs AASHTO T27 (Sieve analysis) as part of the source compliance testing. This allows for a preliminary estimation of the percent of waste material that can be anticipated.

Material proposed for use on any ODOT project must meet the requirements laid out in the [Oregon Standards Specifications for Construction](#) as well as the Special Provisions for the intended use or uses unless modified by the Special Provisions.

## 8.9 Material Source and Disposal Site Exploration Logging

The proper technique and format for logging material source explorations is described in [Chapter 4](#). ODOT utilizes gINT software for the production of exploration logs. Site and exploration photos should be taken in the field at the time of the investigation. Sample and core photos should also be taken. When logging material source explorations, it is very important to note variations in the material even if there is no change in material type or geologic unit.

In gravel and cinder sources, it should be noted where there is a noticeable change either in the size of the material or in the grading. In gravel sites, it is also important to note whether a coating exists on the gravel, and if so, what it consists of.

In quarries, where the overall material type may not change it is still important to note minor differences such as the percent of vesicles, RQD, joint spacing, whether or not the joints are open or closed, and what the in-filling material is if open jointed.

Unit weight changes can also be an important variation that should be noted.

Any groundwater encountered should be noted, and if possible, distinguished from core drill water through checks against draw down or slug tests.

All of these subtle, and in some cases seemingly minor, variations may impact the development of the site for the proposed material use, and will only be obtainable with the proper investigation and logging of the explorations.

Logging holes for proposed material source requires close attention to details.

Another element that differs between material sources and disposal site investigations versus the more common geotechnical hole logging procedures and processes is the locating of various explorations. It is common for material source exploration to take place in advance of any type of formal topographic or other site survey work at a source. In many sources, no identifiable features exist from which to reference hole locations. As such, it is common practice to number each hole, place a survey stake at each location, and to obtain a GPS reading at each exploration hole at the time of exploration. This location information can be used later to assist the survey crew with locating or accurately placing the exploration locations on the overall site maps when surveyed with precise survey-grade equipment. With the recent availability of resource-grade

GPS units such as a Trimble GeoXT or GeoXH, the locations of drill holes and other features can be obtained using these devices, as long as sub-meter accuracy is acceptable.

**Note:**

*GPS receivers used in locating material sources, disposal sites, and exploration site locations should have the datum set to WGS 84 for latitude/longitude and elevation, and International feet for Northing and Easting. Coordinates should be displayed as decimal degrees (D.D<sup>o</sup>) or degrees/ minutes/seconds (D<sup>o</sup>M'S'') only.*

In addition to the GPS readings at every exploration location, a sketch map should be produced showing each hole location and dimensions and direction between holes, again to assist in the accurate placement of hole locations on the detailed site map.

## **8.10 Material Source and Disposal Site Mapping**

Detailed and accurate surface characterization is just as important in material source and disposal site development as the accurate subsurface geologic characterization. Therefore, it is very important to have a high quality, three-dimensional topographic map that includes site features such as drainages, springs, existing roads, fences and property/permit boundaries, as well as the surface contours showing the general land form and any significant changes in slope gradient.

The survey will be based on the Local Datum Plane based on NAD83 and NAVD 88. At least one position, placed on site but out of any development area, will have 1983 Oregon State Plane Coordinates calculated and reported on the face of the map. This position will be a 5/8" x 30" iron rod or the equivalent. Accuracy shall be such as can be achieved by using the NGS OPUS positioning service. In addition, a narrative related to the survey needs to be included that details who did the survey work, exactly what was done, where and when it was completed, and how the work was performed. Included in this narrative should be information regarding which bench marks were used for elevation control, what was used to control the boundary work, and the scale factor between the latitude/longitude and the surveyed local datum plane. The narrative should be placed on the produced map in the area where the north arrow and scale bar is located.

Source design and development plans completed without this level of mapping (digitized features and topographic lines from USGS maps, topographic features collected with resource or recreational grade GPS units, and/or plans developed in GIS) will result in substandard work, and carry with it a much higher degree of risk with a greater potential for construction claims resulting from the inaccurate portrayal of the site features and topography.

In addition to topographic surveying, the site may need to have a boundary survey completed. Boundary work should be completed in accordance with the [ODOT Survey and Policy Manual \(2015\)](#) and DOGAMI regulation [OAR 632-030](#).

## 8.11 Design and Development of Material Sources and Disposal Sites

The investigation work, survey work, and environmental clearances come together in the design phase of the material source and disposal site development. A conceptual design should be formulated in advance of the investigation work, and then modified as needed based on the results of the investigation and clearances. With this information in hand, a source can be strategically developed to meet both the short term project needs and planned future utilization of the resource. Designing a material source requires the detailed analysis of both surface and subsurface information for maximum utilization of the resource in the most efficient and economical manner. Designing a source entry one project at a time without looking at future and long term development and reclamation will lead to poor utilization of the resources and generally lead to much higher costs in the long term. To assure best utilization of a source property or disposal site, the design should be developed and reviewed consistent with the appropriate Region's Quality Control Plan.

Material source and disposal site designs must be stamped by a Certified Engineering Geologist (C.E.G.) as per TSB11-01(D), the [Professional Sealing of Project Special Provisions](#). The registrant who stamps the material source design is the Professional of Record for the material source design.

### 8.11.1 Material Sources and Disposal Sites Slope Design

Slopes are a major consideration in all source and site developments. Final slope requirements by the Department of Geology and Mineral Industries are 1.5H:1V maximum. Slopes in gravel pits, cinder pit and most borrow sites can be developed steeper as working faces but should be reconstructed to 2H:1V or flatter for final slopes. Additional guidance can be found in the [Best Management Practices for Reclaiming Surface Mines in Washington and Oregon, DOGAMI OF 96-2](#)

The flatter slopes will provide for better long term stability and for higher quality reclamation.

The maximum slope requirements imposed by DOGAMI do not differentiate between quarries and other sources, but they may allow for steeper final slopes if steep slopes occur naturally in the area and the construction of steep slopes is approved in advance.

The development of rock slopes in quarries differs slightly from those detailed in [Chapter 11](#). Chapter 11 addresses rock slope development in and along transportation facilities, whereas most material source design will take place off highway, and generally will not require certain aspects of slope construction described in Chapter 11 such as controlled blasting. Occasionally, highway road cuts will be designated as sources of material. When this occurs, the direction and guidance contained in Chapter 11 takes precedent. In quarries, benches are often required, and multiple bench development scenarios are common. In quarries, the stability of the back slopes, as well as the height of the slopes, is an important consideration in the design of the

development plan. In quarries, no working face should be designed steeper than 0.25H:1V in order to prevent overhanging faces. ODOT uses 40 ft as a target maximum height. Actual slope height and slope angle will vary depending on the geology and topography of the sites and at what stage the development of the site is in. In hard rock quarries, a standard “rule of thumb” is to design for 30-ft-wide benches, 40-ft-high high walls at 0.25H:1V slopes between the benches, that will produce an overall 1H:1V slope (top of high wall to outermost bench toe). The steeper 1H:1V slopes can be approved for hard rock quarries when shown to be stable and blend into the natural landscape.

## 8.11.2 Material Sources and Disposal Sites Designed Safety Elements

Safety is a significant concern that needs to be factored into the development and reclamation scheme for every ODOT material source and disposal site. The key site specific safety elements are listed and addressed below.

**Safety Berms:** Axle high safety berms are a Mine Safety and Health Administration (MSHA) requirement along high walls and elevated roadways. The approved Special Provisions call for safety berms in ODOT sites to be constructed a minimum of 3 ft. (1 m) high with side slopes of 2H:1V. The footprint of the safety berms need to be considered when identifying roadway widths or clear areas

for overburden storage and working faces. The requirement for safety berms serves several purposes. They are required by MSHA; but in addition, when the operations are completed, they help to reduce potential liability by leaving the site with these safety features in place.

**Ingress and Egress:** Another key element in the safety of ODOT sources and disposal sites is site entrance/exits and their construction. Related to entrance/exit construction, the main concerns are sight distance, roadway width, safety berm construction, roadway grade, and storm water control. In quarry sites, access to benches should be designed to accommodate tracked vehicles, but prevent easy access to unauthorized rubber tired vehicles. Furthermore, entrance/exit closures should be considered after the operation is completed for the sake of public safety and reduced liability. This is to address the concern of unauthorized vehicle trespass. Restricting access is intended to reduce the possibility of accidents, theft, vandalism, and illegal dumping; therefore, reducing ODOT’s liability. Construction of features to control unauthorized trespass including fences, gates and other forms of entrance/exit closures should be coordinated with the appropriate ODOT Maintenance personnel. If sites have a history or potential for illegal dumping problems, ingress/egress control should be addressed during site development. For example, if fences and gates exist, provisions should be made for their maintenance or improvement. If there are no existing gates or fencing, the possibility of adding these features should be considered during site development.

**Benches:** Benches in quarry sites should be developed as working platforms. The minimum bench width design standard for ODOT quarries should be 30 ft. (10 m). Narrower benches have been used in the past with mixed results. Frequently in quarry development, precision blasting is not used and outer edges of the benches are unstable and tend to break and fall off.



With narrower bench designs, the potential for bench degradation often leads to unworkable benches for future operations. Using the wider design width allows for the inevitable degradation of the outer edge, provides room for placement of a safety berm, and will provide a stable working platform for subsequent entries. If narrower benches are specified for some reason, it needs to be recognized that it is likely they will not be usable during future operations unless controlled blasting techniques are also implemented in the site development.

## **8.12 Drafting of Material Source and Disposal Site Development Plans**

ODOT utilizes Microstation and Inroads computer programs to model and manipulate information gathered for material sources and disposal sites. Development plan maps are drawn in Microstation, while Inroads is used in cross-section development and for quantity calculations. Material source and disposal site drawings should follow the examples available in the Geo-Environmental Drafting Program web site under Specialty Drawings.

## **8.13 Material Source and Disposal Site Operational Specifications**

Boiler plate operational specifications have been developed for material sources and disposal sites and are included in Section 00235 and Section 00236 of the current Boiler Plate Special Provisions. The boiler plate specifications will need to be modified by the source or site designer to address project specifics and permit requirements.

## **8.14 Material Source and Disposal Site Quantity Calculations**

In developing either material sources or disposal sites, it is important to obtain estimated project quantities from the project designers. Keep in mind as projects progress through various stages of design the quantity of material needed or in excess will likely fluctuate. It is important for the source designer to keep in contact with the project designer, especially at the various project milestones, to be aware of the current project estimates. Quantity calculations and the design of a material source or disposal site are intended to assure the source designer that there is adequate material available in the source to meet the anticipated material needs of the project or adequate space in the disposal site to accommodate material from the project.

The construction contractors are ultimately responsible for excavating adequate material to meet the project needs, factoring in the equipment that will be used, the way the products will be produced, and the timing of the production.

There are many factors that influence the final quantity of material needed or generated as described below:

**Shrink/Swell factors:** Common shrink/swell factors for various types of material are available in many different publications. Estimated shrink/swell of an excavated material may or may not influence the design of a material source or disposal site. Estimated shrink/swell factors may be a critical element when designing a disposal site design or attempting to utilize material from a highway road cut as a material source. If there is limited space or quantity, the shrink/swell factor of the material becomes more critical.

**Project materials:** Regarding the materials being produced for a project, some of the factors that will influence the overall project quantities are estimated construction loss, the type of material being produced, the narrowness of the allowed gradational bands, the cleanliness requirements of the produced material, the number of different sizes of material being produced, and the characteristics of the native material. In addition, contractors will influence overall quantities required based on the equipment they bring in and how they opt to produce the required materials. These factors will all influence the overall volume of native material needed to produce the final project requirements. In general, the shrink/swell factors of the material is not a significant design consideration when designing an off-highway material source where the contractors can, within reason, adjust the size of the excavation area based on material characteristics and the planned approach to meeting the project requirements.

**Volume of material:** There are several factors related to the native in-place material besides shrink/swell and construction loss that need to be taken into consideration when calculating the volume of material needed for the project and designing the planned excavation area. In general, gravel sources will produce larger volumes of waste material than quarries due to increased scalping and fracture requirements. As such, when calculating quantities in a gravel pit, it is critical to have a representative sieve analysis of the native material to determine the estimated percent of loss due to the size characteristics of the native material. These factors will need to be evaluated when determining a target quantity for the designed excavation area.

Quarry sites generally produce lower volumes of waste products than gravel sites due to the natural characteristics of the material, but there are still factors that may be encountered in a quarry site that need to be taken into consideration. In some quarry sites the material infilling the joints may be of low quality and may force a contractor to scalp on a larger screen size resulting in extra waste product.

There may be zones within a flow or between different flows that are of lower quality that can be reasonably sorted and removed. These areas would need to be taken into consideration when calculating the overall quantity and source design.

**Quantity calculations:** Quantity calculations for material sources and disposal sites should be based on high quality three dimensional site models coupled with computer generated excavation/embankment design surfaces. For the final development concept that is used in the contract plans, there should be an accompanying computer generated design surface and text report showing the calculated quantities and which surfaces were used to develop these quantities (all products of Microstation and InRoads).

In general, for both quarries and gravel pits, development plans should be designed for an additional 10 percent over the estimated material needs of the project. This extra 10 percent

within the designed excavation area is intended to cover minor quantity variations in the project, as well as a minor amount of variations such as varying overburden depth, irregular rock contacts, or increased scalping requirements over and above what is anticipated based on test results, the subsurface investigation, and the observations of the source designer.

## 8.15 Reclamation of Material Sources and Disposal Sites

Reclamation of material sources and disposal sites should not be considered an afterthought in the design process, or be viewed as an activity that will only take place when the site is ultimately depleted. Reclamation of mined sites is required by Oregon state law [ORS 517](#). Commonly, reclamation plans for a site are a requirement in both the Department of Geology and Mineral Industries (DOGAMI) and the local agency permitting process, and are required prior to site use. How the laws and regulations are implemented and reflected in the source's development is somewhat dependent on the ownership of the property, the long term and planned post mine beneficial use for the property, and the desire of the property owner. There are different requirements for federal lands versus those that are privately or publicly owned.

As with the design of the site, reclamation should be considered in both the short and long term source plan. Certain elements of the design should take into account elements of concurrent reclamation and planning for long term reclamation. Common elements of reclamation include the salvage of overburden and/or soils, re-vegetation plans for seeding and plantings, and planning for final slope configurations and drainage within property boundaries. The overall aesthetics of the reclaimed site should be considered when designing the development and reclamation scheme. In quarry sites, reclamation blasting, coupled with redistribution of soils and subsequent seeding, can be an effective technique for reclaiming slopes.

In designing the reclamation of a disposal site, the post beneficial use of the site is a significant concern. If the future use of the site will be for the placement of a building, proper placement of the material, construction in lifts, and uniform compaction become critical in the site development. If the disposal site is in a rural area and there are no plans for use of the site for a structure, it is more desirable to leave the upper and outer several feet of the material uncompacted, irregularly shaped, and blended into the surrounding topography. This shaping, blending, and lack of compaction on the surface will allow for better re-vegetation and a more natural appearance.

The uneven, roughened surface will also help to reduce erosion. Avoid building a flat topped, rectangular shaped stockpile of disposed of material with long uniform slopes.

## 8.16 Material Source Blasting

Blasting is a common and necessary practice in quarry sites, and used less frequently in the development of gravel sources and disposal sites. Commonly when blasting is planned, concerns are raised by permitting agencies and neighboring land owners. When designing a material source where blasting will be required, special attention needs to be paid to the site's

surroundings. The standard blasting requirements contained in the operational specifications for the material sources should be adequate if no special concerns exist. If there are environmentally sensitive areas or sensitive uses in the vicinity of the blast site, such as nesting sites, wetlands, fish bearing streams, homes, wells, utilities, or other fly rock, vibration and/or noise sensitive facilities, special provisions may need to be added to the standard blasting specifications. Several guidance documents have been developed by ODOT related to blasting and specifically blasting in quarry sites that may provide additional and needed information that are available on the Geo-Environmental [Material Sources website](#).

## **8.17 Material Source and Disposal Site Erosion Control**

Erosion control at material sources and disposal sites represent a significant concern at some locations due to the ground disturbing nature of the activity and the potential for erosion within and off of the source. With any source or disposal site development, there will generally be large areas of disturbed soil that has the potential to result in erosion and sediment transport off of the site. Erosion control is a design element that should be considered and incorporated into the development plan for any material source or disposal site when appropriate. Storm water control is a federally mandated requirement that in Oregon is delegated to the State Department of Environmental Quality (DEQ). When storm water is specifically associated with material sources, regulation and oversight has been delegated from DEQ to the Department of Geology and Mineral Industries (DOGAMI). Erosion control measures associated with the material source or disposal site should be shown on the development plan maps for the source or site rather than the project erosion control plan sheets.

It may be necessary for the source designer to coordinate with an erosion control designer on the project when developing the site specific erosion control elements.

## **8.18 Material Source and Disposal Site Permitting**

Permitting of material sources is a critical element in the design, development, and use of material sources. With very few exceptions, the development and use of material sites will require permits. Ownership of the property, site characteristics, hours of operation, and the proposed extent and quantities of the operation will determine which permit(s) will be required. Permit requirements and/or conditions can influence the way a site is designed and developed. Permitting agencies such as DOGAMI, local public agencies, as well as federal agencies, will require property setbacks and/or buffer zones around drainage and other specific site features that will need to be taken into consideration when laying out the site development. Set back requirements will vary depending on the location of the site, other concurrent uses, and adjacent property ownership issues. Concerns over visual and noise impacts may also influence the direction and depth of development or the placement of stockpiles and berms. Similarly, groundwater, surface water drainages, and erosion control may be concerns to permitting agencies and may influence various elements of the design such as the buffers around these features, depth of the mining, and storm water control features. These concerns

make it critical for a successful design to account for the site characteristics, the limitations of the site, and the likely permit restrictions while still in the design phase. If concerns are not taken into consideration early in the process, there will likely be the need for re-work of the design prior to obtaining final approval of the permits, which may lead to a delay in obtaining the permits and impact the project schedule. **The statewide Material Sources Program Leader should review permit application drafts and development plans prior to agency submittals.**

Disposal sites may also need to be permitted due to added traffic, noise impacts, hours of operation or simply due to the current zoning and the proposed action. The source/site designer will need to verify what permits if any will be required for the proposed activity. ODOT planners and local agency planners can provide information on what permits are necessary for the proposed action and may assist in completing the applications and in obtaining the needed permits.

## **8.19 Material Source and Disposal Site Visual Concerns**

In most situations, there will be no visual concerns to address, but in some areas, the overall visual impact of a material source or disposal site will become a critical element of the design and reclamation. If visuals are a significant concern due to the location of the site or the ability of the site to be viewed from a significant scenic corridor, the impacts or the requirements associated with the visuals will need to be factored into the design and reclamation of the source. In Oregon, there are numerous areas that have varying degrees of scenic value and restrictions (e.g., the Columbia River Gorge Scenic Area, wild and scenic rivers corridors, and the many scenic highway routes). In addition to these nationally and state recognized scenic areas, there are also local scenic designations that may impact a site development. When looking at a site for proposed development, the elements of potential visual restrictions should be evaluated early in the process.

## **8.20 Material Source and Disposal Site Narrative Reports**

Material Source or Disposal Site Narrative reports have multiple purposes. This report, stamped by a Certified Engineering Geologist, provides an opportunity to summarize all of the information that was taken into consideration as part of the site design. In the narrative, the following types of information should be included:

- Location information
- Existing utilities both underground and overhead
- Topography
- Drainage conditions
- Vegetation
- Climate
- Development plan and cross section sheets from the Contract Plans

- Operating specifications
- Regional geology
- Site specific geology
- Exploration logs
- Core or test pit photos
- Site photos
- Currently available lab test results (preferably within last 5 years)
- Groundwater conditions, springs, well locations
- Stability
- Permits and permit conditions
- Source Use History

In addition, the narrative allows the source/site designer to describe both the plan for this particular operation as well as the long term development concept. Concerns related to material characteristics, operational history, past operational problems, design elements, restrictions, and reclamation strategies can all be explained in detail. The narrative provides detailed information as well as assumptions and concerns.

Narratives are part of the contract documentation and are a requirement outlined in the operational specifications for the sources and/or disposal site and are required to be sealed by a CEG stamp. Material source and disposal site narratives are intended to be distributed to all interested contractors who are potentially preparing their bids based on the use of these sites. Therefore, the narrative report should be factual and provide a presentation of data and design assumptions based on the information gathered and considered during site development. Speculative or non-supported assumptions should not be included in the narrative. Each proposed source of materials or disposal site shall have a separate narrative report.

At this time, ODOT has no formal policy that requires that the material source or disposal site narratives be reviewed by others prior to being sealed by the Professional of Record (POR). It is currently recommended that all narratives be reviewed by a competent peer or other registered professional prior to final signatures and affixing a CEG stamp.

An example of a narrative report is available on the ODOT website titled [Material Source Narrative Report Example](#).

Material Source Narratives and Disposal Site Narratives need to be prepared and given to the Construction Project Managers Office in advance of project advertisement. The narrative(s) will be distributed to all interested contractors by the Project Managers Office and a record of who requested the information, as well as when and how it was supplied to them, will be kept and become a part of the project records.

## 8.21 Material Sources and Disposal Sites and Construction

During construction, it is common for questions to arise regarding the source/site development. The Professional of Record (POR) should be available for source/site visits to review and decide upon proposed modifications to the design or to address other development issues.

During construction, at a minimum, the POR or an alternate should plan to be involved with the on-site Pre and Post work meetings. If blasting is required for source development, the POR or alternate would be required for the review of the blast plan and any subsequent modifications of the blast plan. It may also be necessary, depending on how source or site development progresses, for the POR or alternate to witness and document the loading and actual blast(s), and attend other on site meetings to address requested design changes.

The construction project manager should provide a written post construction source or site evaluation to the POR. Information contained within the evaluation should be quantities of material produced or disposed of. It should also include discussion of any problems encountered during site development and/or issues related to the materials produced. If changes were made to source or site development due to conditions encountered, these changes and the reasons for the changes should be noted in the evaluation. A form is available on the website titled [Material Source Post-Construction Report for Public and Private Sources](#).

## 8.22 Material Source Numbering

ODOT has an established numbering system for material source sites. This source numbering system provides each and every site that has been, or is currently, recognized as a potential source of materials for ODOT projects with a unique material source number regardless of material type, ownership, or location. Source numbers are used to match site specific information with material quality information. These source numbers are used by the ODOT Materials Laboratory in Salem for connecting material test results to the source where the material came from. Matching of test results and source numbers allow for the tracking of site history.

The numbering convention used by ODOT is as follows: **ODOT Source # OR-22-013-2**

1<sup>st</sup> two characters are letters that represent the state in which the site is located, for example OR for Oregon, CA for California, WA for Washington, ID for Idaho, and NV for Nevada.

2<sup>nd</sup> two characters are a numeric County code; a two digit county code has been issued for each county in each state that ODOT has recognized sources in.

3<sup>rd</sup> is a three character unique numeric identifier. This three character identifier is automatically assigned to the source when placing the information into the Aggregate Source Information System (ASIS) database.

4<sup>th</sup> character represents the ODOT region that the source exists in or the ODOT region that is closest to the neighboring state where the site is located.

For the example shown above, the number given indicates that the site is located in the State of Oregon (**OR**) and in Linn County (**22**), with a unique source number of 013 (**013**) and is located in ODOT Region 2 (**2**).

Material Source numbers can only be issued by ODOT personnel who have been given computer privilege to do so. These permissions have been limited to those who work in the Geology Units assigned to each Region, and to the Statewide Material Source staff.

### **If a new Source Number is Needed**

If a new site or an existing site that has not previously been issued a source number is identified, the process to get a number assigned to the site is rather simple. The appropriate Region geology staff should be contacted. They will provide a list of information that will need to be supplied in advance of the issuance of a source number. Once the site specific information is supplied to the Region geology staff, the information can be entered into the system and a source number assigned to the site.

## **8.23 Asset Management for Material Sources: Inventory, Evaluate and Record**

Asset management has become a key focus for ODOT. Material sources and sites used for disposal have been recognized as extremely valuable assets in ODOT's inventory. ODOT owns or controls approximately 1500 material sources located along, or in close proximity, to the State's transportation system. Managing these resources is a multi-faceted effort starting with the inventory and evaluation of these sites. Information gathered about the State's material sources is recorded into a database system that represents the primary tool used in managing these assets.

The Aggregate Source Information System (ASIS) is a SQL Server database with a user-friendly Intranet web-based input front end. Each material source, based on their unique source number, is an individual record with approximately one hundred individual data fields available per record. Several data fields are identified as required in each record prior to the system allowing for the record to be saved. Most of the required fields are associated with ownership and location data. Other data fields in each record are optional and may not apply to each source.

Similar to the issuing of source numbers, data input and editing of the database information is restricted to a few personnel within ODOT, primarily region Geology Unit staff members and Statewide Material Source staff who have been given the responsibility for site evaluation, inventory, and updating these records. Access to the information contained within the database is available for review and use by any and all ODOT employees. A link to the ASIS database is available on the ODOT Intranet Material Sources page.



Individual source records contained in ASIS are constantly being updated whenever additional information is obtained for a source. The ASIS database is also undergoing periodic upgrades with additional data fields and functionality.

An ODOT application for collecting physical features within material sources using ArcPad has been developed and is available from the ODOT GIS Unit. All data collected with this application for material sources is tied to the same unique source number contained within the ASIS database. The data collected in the field is downloaded and stored in the ODOT Enterprise Geodatabase and displayed in ArcMap.

With the development of the ArcPad application for materials sources, ODOT now has the GIS database for physical features found in material sources, tied to the ASIS database containing the nonphysical data for these sources. Coupled together, these two databases, and the information contained within them, are used to more effectively manage the ODOT Material Source assets.

Additional tools have been developed to assist ODOT staff in completing site evaluations. One such tool is the [Significant Site Evaluation Form](#). Through the use of this tool and others, ODOT staff is able to evaluate an individual source or site for its individual value and the value of this site within the framework of the ODOT Material Source Network. From these evaluations, ODOT staff can determine if a source or site requires permitting work to protect it for current or future use, or if the property is a candidate to be disposed of. In addition to these efforts, ODOT staff can effectively identify areas around the state where the network of sources/sites is either deficient of sources/sites, or deficient for specific needs, and take the proper steps to correct these deficiencies.

Through effective Asset Management and proper development and permitting of material sources and disposal sites, ODOT can assure the wisest and most efficient use of these resource properties to the benefit of the traveling public and the tax payers.

## 8.24 References

This section intentionally blank

# Chapter 9 - Embankments – Analysis and Design



## Chapter Contents

<b>Chapter 9 - Embankments – Analysis and Design .....</b>	<b>9-1</b>
9.1 General.....	9-3
9.2 Design Considerations .....	9-3
9.2.1 Embankment Materials and Compaction .....	9-3
9.2.2 Embankment Stability .....	9-4
9.2.3 Embankment Settlement .....	9-5
9.3 Stability Mitigation .....	9-5
9.3.1 Staged Construction.....	9-6
9.3.2 Base Reinforcement.....	9-6
9.3.3 Ground Improvement .....	9-6
9.3.4 Toe Berms and Shear keys .....	9-6
9.4 Settlement Mitigation .....	9-7
9.4.1 Acceleration Using Wick Drains .....	9-7
9.4.2 Acceleration Using Surcharges .....	9-7
9.4.3 Lightweight Fills.....	9-7
9.4.4 Subexcavation.....	9-7
9.5 Unusual Foundation Soils.....	9-8
9.6 Bridge Approach Embankments.....	9-8
9.6.1 Approach Slab .....	9-9
9.7 References .....	9-10



## 9.1 General

This chapter addresses the analysis and design of rock and earth embankments. Also addressed are the use of lightweight fill, settlement and stability mitigation techniques. Bridge approach embankments have different requirements and are addressed specifically at the end of this chapter. For the purposes of this chapter, embankments include the following:

- Rock embankments, also known as all-weather embankments, are defined as fills in which the material is non-moisture-density testable and is composed of durable granular materials.
- Earth embankments are fills that are typically composed of onsite or imported borrow, and could include a wide variety of materials from fine to coarse grain. The material is usually moisture-density testable.

Embankments less than 10 feet high are generally designed based on past experience with similar soils and the application of engineering judgment. Embankments greater than 10 feet in height usually require a more detailed geotechnical analysis. Relatively flat (2H:1V or flatter) embankments constructed in accordance with the Standard Specifications, and not subject to submergence, would generally not require rigorous analysis. Any embankment where failure would result in large rehabilitation, on-going maintenance costs or threaten public safety should be designed using more rigorous techniques.

Common causes of embankment failures include the use of excessive slope angles, failure to address seepage, and erosion. Consideration should be given to addressing springs and seeps and establishing vegetation on the slope to prevent long-term erosion. It may be difficult to establish vegetation on slopes with inclinations steeper than 2H:1V without the use of erosion mats or other stabilization methods.

## 9.2 Design Considerations

### 9.2.1 Embankment Materials and Compaction

New embankments and embankment widening require the placement of suitable fill materials, properly compacted with correct equipment based on the material type. The *ODOT Standard Specifications for Construction* provides embankment construction methods for soil, non-durable rock and rock materials. Non-durable rock materials may require additional compaction effort beyond standard construction methods to prevent long-term deflections associated with degradation of the embankment materials. The geotechnical designer should determine during the exploration program if any of the material from planned earthwork excavations will be suitable for re-use as embankment. Consideration should be given as to whether the material is moisture sensitive and difficult to compact during wet weather.

#### 9.2.1.1 All-Weather Embankment Materials

ODOT projects frequently require embankment fill construction during the wet-weather months (typically October through May). Clean, granular, all-weather embankment materials

improve the contractor's ability to properly place and compact fill materials during the wet-weather months. *ODOT Standard Specifications* identify include two materials generally suitable for wet-weather construction: Selected Stone Backfill (00330.15), and Stone Embankment Material (00330.16).

### 9.2.1.2 Non-Durable Rock Materials

Special consideration should be given during design to the type of material that will be used in rock embankments. In some areas of the state, moderately weathered or very soft rock may be used as embankment fill. For embankment construction with non-durable rock materials, the following guidelines should be followed:

- Degradable fine-grained sandstone and siltstone are often encountered in the cuts and the use of these materials in embankments can result in significant long-term deformations and stability problems as the rock degrades. Avoiding this subsequent collapse requires that the embankment fill be pulverized, watered, and compacted properly compacted with heavy tamping foot rollers (Machan, et al., 1989). The slake durability test (ASTM D4644) is required during construction to determine handling and compaction requirements of non-durable rock. The slake durability test should also be performed during design to anticipate the performance of the rock in construction.
- When the rock is found to be non-durable, it should be physically broken down and compacted as earth embankment, provided the material meets or exceeds common borrow requirements. Special compaction requirements, defined by method specification, may be needed for these materials. In general, tamping foot rollers work best for breaking down the rock fragments. The minimum size roller should be 30 tons, note this is a much larger roller than is required in the standard specifications. Specifications should include the maximum size of the rock fragments and maximum lift thickness. These requirements will depend on the hardness of the rock, and a test section should be incorporated into the contract to verify that the Contractor's methods will achieve compaction and successfully break down the material. In general, both the particle size and lift thickness should be limited to 12 inches.

## 9.2.2 Embankment Stability

Embankment stability design should be consistent with state-of-the-practice design guidelines, as discussed in [Chapter 9](#). Stability design shall be evaluated using conventional limit equilibrium methods, and analyses should be performed using a state-of-the-practice slope stability computer program such as the most current versions of Slope/W<sup>®</sup> (Geo-Slope International), Slide<sup>®</sup> (Rocscience, Inc.), and/or ReSSA<sup>®</sup> (ADAMA Engineering, Inc.).

### 9.2.2.1 Safety Factors

For embankments adjacent to but not directly supporting structures, a maximum resistance factor of 0.75 should be used. Where embankments support structures such as bridges, approach slabs, retaining walls, and minor structures, a maximum resistance factor of 0.65

should be used. These resistance factors of 0.75 and 0.65 are generally equivalent to a safety factor of 1.3 and 1.5, respectively.

### 9.2.2.2 Strength Parameters

Strength parameters are required for any stability analysis. Strength parameters appropriate for the different types of stability analyses are determined based on [Chapter 6](#) and [Chapter 8](#). Both short and long term stability need to be assessed.

## 9.2.3 Embankment Settlement

Embankment settlement analysis should be based on the methods in *FHWA Soils and Foundation Reference Manual*, (Samtani and Nowatzki, 2006) and Section 10 of the *AASHTO LRFD Bridge Design Specifications*. Because primary consolidation and secondary compression can continue to occur long after the embankment is constructed (post construction settlement), they represent the principal settlement concerns for embankment design and construction. Post construction settlement can damage structures, **pavement structures**, and utilities located within **and atop** the embankment, especially if those facilities are also supported **in such a way as to limit deflection**, leading to differential settlements. Many construction projects cannot absorb the scheduling impacts associated with waiting for primary consolidation and/or secondary compression to occur. Therefore, estimating the time-rate of settlement is often as important as estimating the magnitude of settlement.

Key parameters required to calculate the time-rate and magnitude of embankment settlement include:

- The subsurface profile including soil types, layering, groundwater levels and unit weights.
- The **indices** for recompression, primary and secondary compression from laboratory consolidation test data, correlations from index properties, or results from settlement monitoring programs at nearby sites with similar soil conditions.
- The geometry of proposed fill embankments, including fill unit weight and any long-term surcharge loads.

Analysis of primary consolidation and secondary compression settlements should be performed by hand-calculation, using Excel spreadsheet or MathCAD, or with a state-of-the-practice computer program such as the most current versions of FoSSA<sup>®</sup> (ADAMA Engineering, Inc.).

## 9.3 Stability Mitigation

A variety of techniques is available to mitigate inadequate slope stability for new embankments or embankment widening. These techniques include staged construction to allow the underlying soils to gain strength, base reinforcement, ground improvement, and construction of toe berms (counterweights) and shear keys. An overview of these instability mitigation techniques is presented below.

### 9.3.1 Staged Construction

Where soft compressible soils are present below a new embankment location, and it is not economical to remove and replace these soils with compacted fill, the embankment can be constructed in stages. This approach allows for consolidation and dissipation of excess pore pressures within the compressible soils. Construction of the second and subsequent stages commences when the strength of the compressible soils is sufficient to maintain stability under the subsequent applied loads. In order to define the allowable height of fill for each stage and maximum rate of construction, detailed geotechnical analysis is required. This generally includes both limit equilibrium slope stability and time rate of settlement analyses. Field monitoring of settlement and pore water pressures should be specified for quality control during construction.

### 9.3.2 Base Reinforcement

Base reinforcement typically consists of placing at least two, closely spaced geogrid layers near the embankment base with a high-strength geotextile used as a separator between the embankment and foundations soils. Base reinforcement may be used to increase the factor of safety against slope failure. Base reinforcement is particularly effective where soft/weak soils are present below a planned embankment location. The base reinforcement can be designed for either temporary or permanent applications. Since the reinforcement is needed only until the foundation soil has developed sufficient shear strength to maintain stability, the base reinforcement geogrid design does not require application of the full strength reduction factor for creep effects. Holtz, et al. (1995) provides a suitable design methodology for embankment base reinforcement. It is typical when using base reinforcement to not compact the, typically soft, native grade. As such, the use of base reinforcement would typically require the development of project-specific special provisions.

### 9.3.3 Ground Improvement

Refer to [Chapter 14](#) for references and information on ground improvement design. Ground improvement is typically used to address seismic performance given the relatively high cost. It may be appropriate for sites where overexcavation and/or embankment reinforcement are not feasible.

### 9.3.4 Toe Berms and Shear keys

Toe berms and shear keys are methods to improve the stability of an embankment by increasing the resistance along potential failure surfaces. Toe berms are typically constructed of granular materials that can be placed quickly, do not require much compaction, and have relatively high shear strength. ODOT would typically specify the use of Stone Embankment Material when toe berms and shear keys are required.



## 9.4 Settlement Mitigation

### 9.4.1 Acceleration Using Wick Drains

Wick drains, or prefabricated drains, are, in essence, vertical drainage paths that can be installed into compressible soils to decrease the overall time required for completion of primary consolidation. Wick drain design considerations, example designs, guideline specifications, and installation considerations are provided by reference in [Chapter 14](#). Section 00435 of the *ODOT Standard Specifications* addresses installation of wick drains.

### 9.4.2 Acceleration Using Surcharges

Surcharge loads are additional loads placed on the fill embankment above and beyond the finish grades. The primary purpose of a surcharge is to speed up the consolidation process. Two significant design and construction considerations for using surcharges include embankment stability and re-use of the additional fill materials. New embankments over soft soils can result in stability problems. Adding additional surcharge fill could exacerbate the stability problem. Furthermore, after the settlement objectives have been met, the surcharge will need to be removed. If the surcharge material cannot be moved to another part of the project site for use as site fill or as another surcharge, it is often not economical to bring the extra surcharge fill to the site only to haul it away again. Also, when fill soils must be handled multiple times (such as with a “rolling” surcharge), it is advantageous to use gravel borrow to reduce workability issues during wet weather conditions.

The design of surcharges requires a high level of knowledge with respect to time rate of consolidation. As such, surcharge design should only be undertaken based on a rigorous laboratory testing program, including numerous consolidation tests or from fill settlement data collected from an adjacent site in the same soils. Even with such data, the design of a surcharge requires a significant amount of engineering judgement. The drainage flowpath distance is a principal driver in predicting consolidation rates and is to reliably determine from subsurface explorations.

### 9.4.3 Lightweight Fills

Lightweight fills can also be used to mitigate settlement issues as indicated in [Section 9.3.4](#). Lightweight fills reduce the new loads imposed on the underlying compressible soils, thereby reducing the magnitude of the settlement. When considering the use of lightweight fills a number of significant issues must be addressed including material, cost, constructability, and buoyancy.

### 9.4.4 Subexcavation

Subexcavation refers to excavating the soft compressible or unsuitable soils from below the embankment footprint and replacing these materials with higher quality, less compressible material. Because of the costs associated with excavating and disposing of unsuitable soils as well as the difficulties associated with excavating below the water table, sub excavation and

replacement typically only makes economic sense under certain conditions. Some of these conditions include, but are not limited to:

- The area requiring over excavation is limited;
- The unsuitable soils are near the ground surface and do not extend very deep (typically, even in the most favorable of construction conditions, sub excavation depths greater than about 10 ft. are in general not economical);
- Temporary shoring and dewatering are not required to support or facilitate the excavation and;
- Suitable materials are readily available to replace the over-excavated unsuitable soils.

## 9.5 Unusual Foundation Soils

Deposits of unusual foundation soils are present throughout Oregon. These include highly organic soils such as peat deposits and diatomaceous formations. In some instances, conventional consolidation theory is not applicable since an underlying assumption of consolidation theory is that the soil grains are incompressible. Detailed evaluation of unusual formations should be based on published research and practices as well as past experience in the area.

## 9.6 Bridge Approach Embankments

The FHWA publication “Soils and Foundations Reference Manual”, (Samtani, 2006) should be referenced for guidance in the analysis and design of bridge approach embankments. New embankments placed for bridge approaches should be evaluated for short term (undrained) and long term (drained) conditions.

Bridge end slopes are designed at 2H:1V. Bridge treatments often include slope paving and hydraulic countermeasures are designed and stable at 2H:1V slopes. If steeper end slopes are anticipated, close coordination with the bridge and hydraulic engineers needs to occur. Regardless of slope inclination, the slopes are evaluated for stability and designed to meet the required resistance for static and seismic load cases. Ground improvement should not be used as a mitigation to use steeper slopes.

The evaluation of slope stability using limit equilibrium methods is addressed in detail in [Chapter 8](#). For overall stability, the minimum static factor of safety for bridge approach embankments is 1.5. This includes the consideration of abutment spread footings or retaining walls supported directly on the proposed embankments. Dynamic (seismic) slope stability, settlement, and lateral displacements are discussed in [Chapter 7](#).

As specified in Article 11.6.2.3 of the AASHTO, the evaluation of the overall stability of earth slopes with foundation units shall be evaluated at the Service I limit state and a resistance factor,  $\phi_{os}$ , of 0.65, which corresponds to a factor of safety of 1.5. The analysis will address the impact of a maximum bearing stress equal to the specified service limit state bearing resistance.

If the foundation is located on the slope such that the foundation load contributes to slope instability, the designer shall establish a maximum footing load that is acceptable for maintaining overall slope stability for Service, and Extreme Event limit states. If the foundation is located on the lower portion of the slope such that the foundation load increases slope stability, overall stability of the slope shall be evaluated ignoring the effect of the footing on slope stability.

In general, approach embankments should be designed to limit long-term settlement to less than 1" in 20 years. Refer to the ODOT BDM for additional approach fill settlement limitations regarding integral abutments. If estimated post-construction settlements are more than 1" report this value in the Geotechnical Report and consider implementing the techniques discussed in [Section 9.4](#). An additional option to consider is relocating the bridge end bents, if doing so would result in markedly reduced embankment settlement. An additional consideration specific to bridge embankments is settlement-induced down drag loads on piles and drilled shafts.

### **9.6.1 Approach Slab**

The standard practice at ODOT is to provide bridge approach slab (20' in length) at each end bent location for bridges constructed on the State Highway system. Post construction embankment settlement frequently occurs at this transition point and approach slab assist in eliminating a potentially dangerous traffic hazard. They further reduce the impact of traffic loads to the bridge. Although approach slabs are effective in mitigating minor levels of movement, excessive levels of embankment settlement will still require expensive mitigation. Such excessive settlement is typically the result of poorly compacted embankment fills or long-term consolidation of the foundation soils.

Eliminating the end panels may be considered if the following geotechnical conditions are met:

- Foundation materials are nominally incompressible (e.g., bedrock or very dense granular soils)
- Post-construction settlement estimates are negligible (<0.25")
- Provisions are made to ensure the specifications for embankment and backfill materials, placement and compaction are adhered to (increased inspection and testing QC/QA)

The elimination of approach slab requires a geotechnical and structural evaluation and an approved Bridge deviation. The final decision on whether or not to eliminate approach slabs shall be made by the ODOT State Bridge Engineer after consideration of the geotechnical and structural evaluations.

In addition to geotechnical criteria, other issues such as average daily traffic (ADT), design speed, or accommodation of certain bridge structure details may supersede the geotechnical reasons for eliminating approach slabs. Approach slabs shall be used for all ODOT bridges with stub, or integral abutments to accommodate bridge expansion and contraction. Approach slabs are used in all cases which result in excessive fill settlement due to seismic loads and failure to meet the performance criteria described in the BDM.

## 9.7 References

Holtz, R. D., Christopher, B. R., and Berg, R. R., 1995, [Geosynthetic Design and Construction Guidelines](#), Federal Highway Administration, FHWA HI-95-038.

Machan, G., Szymoniak, T. and Siel, B., 1989, [Evaluation of Shale Embankment Construction Criteria](#), Experimental Feature Final Report OR 83-02," Oregon State Highway Division, Geotechnical Engineering Group.

Samtani, N. and Nowatzki, E. (2006), Soils and Foundation Reference Manual, Volumes I and II, Report No. FHWA NHI-06-088.

Collin, J.G., et al, 2005, U.S. Department of Transportation, Federal Highway Administration, Soil Slope and Embankment Design Reference Manual, FHWA-NHI-05-123.

Samtani, N.C. and Nowatzki, E. A., 2006, U.S. Department of Transportation, Federal Highway Administration, Soils and Foundations Reference Manual, FHWA-NHI-06-088.

# Chapter 10 - Soil Cuts - Analysis and Design



## Chapter Contents

<b>Chapter 10 - Soil Cuts - Analysis and Design</b> .....	<b>10-1</b>
10.1 General.....	10-2
10.2 Soil Cut Design.....	10-2
10.2.1 Design Approach and Methodology.....	10-2
10.2.2 Seepage Analysis and Impact on Design.....	10-3
10.2.3 Surface and Subsurface Drainage Considerations and Design.....	10-3
10.2.4 Stability Improvement Techniques.....	10-4
10.2.5 Erosion and Piping Considerations.....	10-5
10.2.6 Sliver Cuts.....	10-5
10.3 References.....	10-5

## 10.1 General

Soil cut slope design must consider many factors such as the materials and conditions present in the slope, **grade and right of way constraints**, minimization of future maintenance, and slope erosion. Soil slopes less than 10 feet high are generally designed based on past experience with similar soils and **the application of** engineering judgment. Cut slopes greater than 10 feet in height require a more detailed geotechnical analysis. Relatively flat (2H:1V or flatter) cuts in granular soil when groundwater is not present above the ditch line, **would generally** not require rigorous analysis. Any cut slope where failure would result in large rehabilitation costs or threaten public safety is designed using more rigorous techniques. **Other situations** that warrant more in-depth analysis include:

- Cuts with irregular geometry,
- Cuts with varying stratigraphy (especially if weak zones are present),
- Cuts where high groundwater or seepage forces are likely,
- Cuts involving soils with questionable strength, or
- Cuts in old landslides or in formations known to be susceptible to landsliding.

**Common** causes of cut slope failures **include** **the use of excessive slope angles, failure to address seepage in design,** and the presence of overconsolidated clays **or unfavorably bedded formations**. Careful consideration should be given to preventing these situations by choosing appropriate **design details**.

The **design of a cut slope in soil requires knowledge of slope geometry constraints,** shear strength, and groundwater **and seepage** levels. **Further consideration must be given to** adequate surface and subsurface drainage facilities to reduce the potential for future stability or erosional problems.

## 10.2 Soil Cut Design

### 10.2.1 Design Approach and Methodology

Safe design of cut slopes is typically based on past experience or on more in-depth analysis. Both approaches require accurate **site-specific** information regarding geologic conditions, obtained from standard field and laboratory classification procedures. Design guidance for simple projects is provided in the *ODOT Highway Design Manual*. **This simplified approach** can be used **on ODOT projects except where** indicated otherwise by the geotechnical designer. Slopes less than 10 feet high, **at gradients** flatter than 2H:1V may be used without in-depth analysis if no special concerns are noted by the geotechnical designer. If the geotechnical designer determines that a slope stability study is necessary, information that will be needed for analysis includes:

- An accurate cross section showing topography,
- Proposed grade,
- Soil unit profiles,
- Unit weight and strength parameters for each soil unit, and

- Location of the water table and seepage characteristics.

The design factor of safety for static slope stability is 1.25. This safety factor should be increased to a minimum of 1.30 for slopes where failure would cause significant impact to adjacent structures. For pseudo-static seismic analysis the factor of safety can be decreased to 1.1. Cut slopes are generally not designed for seismic conditions unless slope failure could impact adjacent structures. These factors of safety should be considered as minimum values. The geotechnical designer should decide on a case by case basis whether or not higher factors of safety should be used based the consequences of failure, past experience with similar soils, and uncertainties in analysis related to site and laboratory investigation.

Preliminary slope stability analysis can be performed using simple stability charts. See Abramson, et al. (1994) for example charts. These charts can be used to determine if a proposed cut slope might be subject to slope failure. If slope instability appears possible, or if complex conditions exist beyond the scope of the charts, more rigorous computer methods can be employed (see [Chapter 8](#)).

## 10.2.2 Seepage Analysis and Impact on Design

Groundwater seepage is perhaps the most common cause of slope failures. A higher groundwater table results in higher pore pressures, causing a corresponding reduction in effective stress and soil shear strength. A cut slope below the groundwater table results in destabilizing seepage forces. In turn it adds weight to the soil mass and increases driving forces for slope failures. It is important to identify and accurately model seepage within proposed cut slopes so that adequate slope and drainage designs are employed.

For slope stability analyses requiring effective stress parameters, pore pressures have to be known or estimated. This can best be done by measuring the phreatic (water table) surface with electronic piezometers, open standpipes, or observation wells. Piezometric data can be used to estimate the phreatic surface or piezometric surface if confined flow conditions exist. A manually prepared flow net or a numerical method such as finite element analysis can be used to provide sufficient boundary information.

## 10.2.3 Surface and Subsurface Drainage Considerations and Design

The importance of adequate drainage cannot be overstated when designing cut slopes. Surface drainage can be accomplished through the use of drainage ditches and berms located above the top of the cut, around the sides of the cut, and at the base of the cut. Surface drainage facilities should direct surface water to suitable collection facilities.

Subsurface drainage should be employed to reduce driving forces and increase soil shear strength by lowering the water table, thereby increasing the factor of safety against a slope failure. Subsurface conditions along cut slopes are often heterogeneous. Thus, it is important to accurately determine the geologic and hydrologic conditions at a site in order to place drainage systems where they will be the most effective. Subsurface drainage techniques available include:

- **Cut-off trenches:** Cut-off trenches, also known as French drains, are a gravel filled trench near the top of the cut slope to intercept groundwater and convey it around the slope. They are effective for shallow groundwater depths from 2 to 15 feet deep.
- **Horizontal drains:** If the groundwater table needs to be lowered to a greater depth, horizontal drains can be installed, if the soils are cohesive and granular in nature. Horizontal drains are generally not very effective in finer grained soils. Horizontal drains consist of small diameter holes drilled at slight angles into a slope face and backfilled with perforated pipe wrapped in drainage geotextile. Installation might be difficult in soils containing boulders, cobbles or cavities. Horizontal drains require periodic maintenance as they tend to become clogged over time.
- **Relief wells:** Relief wells can be used in situations where the water table is at a great depth. They consist of vertical holes cased with perforated pipe connected to a disposal system such as submersible pumps or discharge channels similar to horizontal drains. They are generally not common in the construction of cut slopes.

Whatever subsurface drainage system is used, monitoring should be implemented to determine its effectiveness. Typically, piezometers or observation wells are installed during exploration. These should be left in place and periodic site readings should be taken to determine groundwater levels or pore pressures depending on the type of installation. High readings would indicate potential problems that should be mitigated before a failure occurs.

Surface drainage, such as brow ditches and seepage control, should be applied to all cut slopes as the cut progresses. Furthermore, the surface drainage should be conveyed to the toe of the cut slope. The use of subsurface drainage structures is an effective way to improve the stability of cut slopes where water and/or seepage is present. However, it should be noted that subsurface drainage can be expensive and requires maintenance. It should be used in conjunction with other techniques (outlined below) to develop the most cost effective design that meets the required factor of safety.

## 10.2.4 Stability Improvement Techniques

There are a number of options that can be used in order to increase the stability of a cut slope. Techniques include:

- Flattening slopes,
- Benching slopes,
- Lowering the water table (discussed previously),
- Structural systems such as retaining walls or reinforced slopes.

Changing the geometry of a cut slope is often the first technique considered when looking at improving stability. For flattening a slope, enough right-of-way must be available. As mentioned previously, stability in purely dry cohesionless soils depends on the slope angle, while the height of the cut is often the most critical parameter for cohesive soils. Thus, flattening slopes usually proves more effective for granular soils with a large frictional component.



Structural systems are generally more expensive than the other techniques, but might be the only option when space is limited. Shallow failures and sloughing can be mitigated by placing a 2 to 3-foot thick rock drainage blanket over the slope in seepage areas. Moderate to high survivability permanent erosion control geotextile should be placed between native soil and drain rock to keep fines from washing out and/or clogging the drain rock. In addition, soil bioengineering can be used to stabilize cut slopes against shallow failures (generally less than 3 feet deep), surface sloughing and erosion along cut faces.

### 10.2.5 Erosion and Piping Considerations

Surface erosion and subsurface piping are most common in clean sands, neoplastic silts and dispersive clays. Loess and volcanic ash are particularly susceptible. However, all cut slopes should be designed with adequate drainage and temporary or permanent erosion control facilities to limit erosion and piping as much as possible. The amount of erosion that occurs along a slope is a factor of soil type, rainfall intensity, slope angle, length of slope, and vegetative cover. The first two factors cannot be controlled by the designer, but the last three factors can. Longer slopes can be terraced at approximate 15-foot to 30-foot intervals with drainage ditches installed to collect water. Best Management Practices (BMPs) for temporary, permanent erosion and storm water control **are** outlined in the *ODOT Highway Design Manual* **and** should always be used. Construction practices specify **the** limit, extent and duration of exposed soil **where erosion is a concern**. For cut slopes, consideration should be given to limiting earthwork during the wet season and requiring that slopes be covered as they are exposed, particularly for the highly erodible soils mentioned above.

### 10.2.6 Sliver Cuts

A sliver cut is defined as slope excavation less than 10 feet wide over some or all of its height. Sliver cuts in soils should be avoided because they are difficult to build. Cuts at least 10 feet wide over the full height of the cut require the use of conventional earth moving machinery to maximize production. Cuts less than 10 feet wide and up 25 feet high measured along the slope can be excavated with a large backhoe but at the expense of production. If a sliver cut is used, consider how it will be built and be sure to account for the difficulty in the cost estimate.

## 10.3 References

Abramson, L., Boyce, G., Lee, T., and Sharma, S., 1994, *Advanced Technology for Soil Slope Stability*, Vol. 1, FHWA-SA-94-005.

Samtani, Naresh C., Nowatzki, Edward A., 2006, FHWA, *Soils and Foundations Workshop Manual*, FHWA-HI-06-088.

Turner, A., and Schuster, R., 1996, *Landslides: Investigation and Mitigation*, TRB Special Report 247.

# Chapter 11 - Rock Cuts – Analysis, Design, and Mitigation

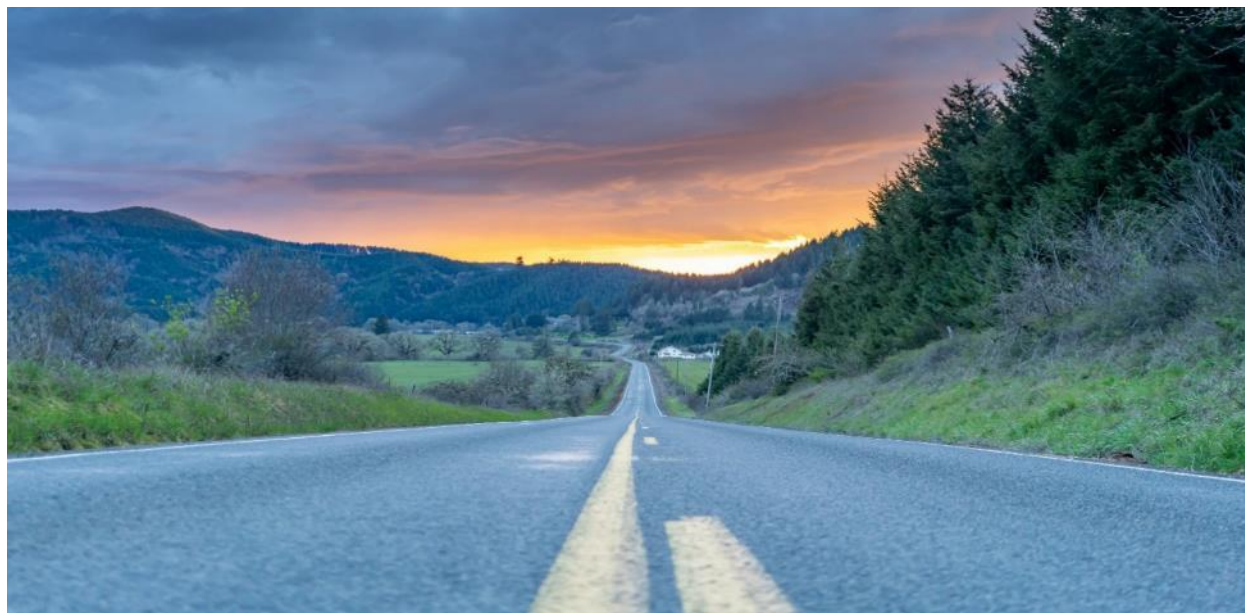

## Chapter Contents

<b>Chapter 11 - Rock Cuts – Analysis, Design, and Mitigation.....</b>	<b>11-1</b>
11.1 General.....	11-3
11.2 ODOT Rock Slope Design Policy.....	11-3
11.2.1 Rock Slope Design.....	11-3
11.2.2 Rock slope Fallout Areas.....	11-3
11.2.3 Benches.....	11-4
11.2.4 Rock Slope Stabilization and Rockfall Mitigation Techniques.....	11-5
11.3 Rock slope Stability Analysis.....	11-5
11.4 Design Guidelines.....	11-5
11.4.1 Geologic Investigation and Mapping.....	11-5
11.4.2 Analysis and Design.....	11-6
11.4.3 Construction Issues.....	11-6
11.4.4 Blasting Consultant.....	11-7
11.4.5 Wire Mesh Slope Protection/ Cable Net Slope Protection.....	11-7
11.4.6 Rock Reinforcing Bolts and Rock Reinforcing Dowels.....	11-7
11.4.7 Proprietary Flexible Rockfall Barrier Systems.....	11-8
11.4.8 Pinned Cable and Wire Mesh Systems.....	11-8
11.4.9 Rock fall Attenuator Systems.....	11-8
11.5 Standard Details.....	11-8
11.6 Specifications.....	11-9

11.6.1 Blasting ..... 11-9

11.6.2 Rock slope Mitigation Methods ..... 11-9

11.7 References ..... 11-10

## 11.1 General

This chapter discusses the analysis, design guidelines, and standards for rock slopes adjacent to highways. Rock slope design for material sources is discussed in [Chapter 8](#).

## 11.2 ODOT Rock Slope Design Policy

The purpose of the policy is to establish slope design standards for rock cuts and to encourage the active involvement of geologists and geotechnical engineers in the rock slope design process. This involvement is intended to ensure that rock slopes are safe to construct and economical and will optimize safety for the public. In general, the policy includes four sections that deal with rock slopes. These sections cover the rock slope design, rock fallout area requirements, the use of benches, and rock slope stabilization and mitigation techniques.

### 11.2.1 Rock Slope Design

The purpose of the rock slope design is to develop rock cuts that will be safe to construct and will provide long-term safety for the public. The inclination of rock slopes should be based on the structural geology and stability of the rock units, as described in the Geology or Geotechnical Report. Rock unit slopes of vertical, 0.25:1, 0.5:1, 0.75:1 and 1:1 are commonly considered. The design rock cut slope should be the steepest continuous slope (without benches) that satisfies physical and stability considerations. Controlled blasting (using presplit and trim blasting techniques) is required for rock cut slopes from vertical to 0.75:1. The purpose of controlled blasting is to minimize blast damage to the rock backslope to help insure long-term-stability, improve safety, and lessen maintenance. See [Section 11.5](#) for more details regarding rock slope design.

### 11.2.2 Rock slope Fallout Areas

Fallout areas should be used where hazardous rock fall could occur. The fallout area is a non-traveled area between the highway and the cut slope with minimum width, depth, and slope requirements. The minimum dimensions should be determined based on slope inclination and height. The depth of the fallout area varies with the slope configuration. A preliminary determination of the fallout area or catch ditch dimensions can be obtained from the Ritchie Rock fall Catch Ditch Design Chart located in the *ODOT Highway Design Manual, section 10.4*.

Final catch ditch dimensions should be determined using the *Rock fall Catchment Area Design Guide* (FHWA Final Report SPR-03(032)).

As noted in the 2003 *ODOT Highway Design Manual, section 10.4.4*, a goal of 90% retention of rock in the catchment area has been adopted for all new and reconstructed rock slopes. In addition, a goal of 99% retention of free falling rocks is also recommended. These goals may not be achievable in all cases due to cost, environmental reasons, or other factors. In these cases additional stabilization measures such as draped mesh and rock bolting should be evaluated.

The retention goals should also be considered with respect to the nature of the rock slope and rockfall activity that occurs at the individual site. Low-frequency/high impact sites, areas of

heavy traffic, or unfavorable roadway geometry may necessitate higher retention. Since rockfall mitigation projects are commonly funded to a preset budget, designs for a lower than optimal containment may result. This should not discourage designers from improving the situation at a hazardous rock slope even if the value is less than the adopted goal if the increased retention is cost-effective. Projects that partially mitigate rockfall hazards should be constructed so that future efforts at greater retention are not inhibited.

The catchment area depth may be achieved in a number of ways, including excavation and/or placing suitable retaining structures at the highway shoulder. Where the slopes are inclined at flatter than 0.75:1, and where the anticipated size of a single rock is less than 2 feet in diameter, chain link catch fences may be considered as a substitute for depth of fallout. Slopes less than 40 feet high and flatter than 1:1 generally have a ditch and recoverable slope equal to or greater than a fallout ditch shown in the Rock fall Catchment Area Design Guide. In that case, the standard roadway ditch will serve as adequate rock fall catchment. For rock slopes greater than 80 feet, the designer should use rockfall simulation programs discussed in [Section 11.3](#) and ditch design guidelines discussed in [11.4.2](#).

Temporary detours may require the construction of rock slopes and fallout areas. If the site has previously been an area of rock fall activity, and the detour will reduce the fallout area, thereby putting motorists in increased risk, the rock slope and fallout area must be designed to, at a minimum, not increase the risk to the public. Fallout areas should then be designed to capture or retain at least as much rock fall as was previously available prior to construction. Additional mitigation measures, along with one-way travel, reduced travel speed in the rock fall zone, and increased sight distances may be required to reduce risk to the public. The designer should be prepared to address all of these issues in the design process.

### **11.2.3 Benches**

For most rock slope designs, benches should be avoided. The need for benches will be evaluated in the geology and geotechnical investigations and described in the resulting reports. The minimum bench design should satisfy the requirements outlined in the Rock fall Catchment Area Design Guide. The bench configuration may be controlled by the need to perform periodic maintenance, which requires access to the bench. Soil and rock slopes may need a modification with benches to conform to the environment or for safety and economic concerns. Following are some appropriate bench applications.

- Benching may improve slope stability where continuous slopes are not stable.
- Where maintenance due to sloughing of soil overburden may be anticipated, a bench will provide access and working room at the overburden rock contact.
- Developing an access bench may facilitate construction where the top of cut begins at an intermediate slope location.
- On very high cuts, benches may be included for safety where rock fall is expected during construction.
- Where necessary, benches may be located to intercept and direct surface water runoff and groundwater seepage to an appropriate collection facility.
- All benches should be constructed to allow for maintenance access.

## 11.2.4 Rock Slope Stabilization and Rockfall Mitigation Techniques

Rock slope stabilization techniques may be required to accommodate special geologic features. Stabilization techniques include rock bolts and dowels, wire mesh and cable net slope protection, flexible and rigid rock fall barriers, reinforced shotcrete, trim and production blasting. Specific stabilization techniques with appropriate design will be recommended in the Geotechnical Report as necessary. Refer to [Section 11.4](#) for more detail.

## 11.3 Rock slope Stability Analysis

Slope stability analysis for rock slopes involves a thorough understanding of the structural geology and rock mechanics. Only geotechnical practitioners experienced in collecting and analyzing rock structure data should perform these functions. For most rock cuts on highway slopes, the stresses in the rock are much less, than the rock strength so there is little concern with the fracturing of the intact rock. Therefore, stability is concerned with the stability of rock blocks formed by the discontinuities. Field data collection of the dip, dip direction, nature, and type of joint infilling, joint roughness and spacing are important for the stability analysis of planar, wedge and toppling failure modes. Slope height, angle, presence of potential rock launching features, block size, and block shape are important for the analysis and design of rock fall mitigation techniques. Hand-calculation methods can be used to analyze potential planar and wedge failures and computer programs such as Rocscience DIPS, SWEDGE, RocTopple, and ROCPLANE are available. Rock fall simulation programs, such as CRSP (Colorado Rock fall Simulation Program) or RocFall, are used to analyze for rock fall catchment size and the prediction of rock kinetic energy. Only geotechnical practitioners experienced in using these programs should perform the analysis. There are several references available for details on design, excavation, and stabilization of rock slopes including Wyllie and Mah, 1998.

## 11.4 Design Guidelines

General design guidelines are found in the references listed in [Section 11.7](#). Design of rock slopes adjacent to ODOT highways must also include consideration of additional factors such as environmental issues, history of rockfall hazards, cost, risk/benefit, and needs of the project. The following guidelines provide information on ODOT rock slope design.

### 11.4.1 Geologic Investigation and Mapping

For projects that include rock cuts, the geotechnical designer should contact the local Maintenance district office to discuss, the history of past rock fall events and consult the Region Geologist for the project area to determine the Unstable Slopes System score and priority for that highway and for the Region. The designer should also discuss the geologic hazard potential with the Region Geologist so that a consensus on the degree of rock fall potential is reached. The discussions will serve to highlight concerns regarding construction, local environmental

needs, and feasible options for mitigation of the hazard. The development and implementation of the geologic investigation can then be completed.

Field data collection is generally done on a project site-specific basis. Wiley and Mah, 1998, discusses joint mapping techniques, stereographic projection, and types of subsurface exploration that may be performed on rock slopes. Full-scale tests of rock fall at the site may also be performed, however, the cost and practicality of traffic control generally prevents this type of work.

### **11.4.2 Analysis and Design**

As previously stated, analysis of planar, wedge and toppling failure modes can be performed by hand or with some available computer programs. Wiley and Mah, 1998, discusses the analysis in detail.

Simulation of rock fall using the CRSP or RocFall computer program may be needed to determine the minimum required dimensions of a rock fall catch ditch and the kinetic energy of rocks that may need to be restrained by barriers, wire mesh, screens, or walls. As a rule of thumb, draped gabion wire or 0.079 to 0.118 in (2 mm to 3 mm) high tensile strength mesh slope protection and screens are capable of withstanding impacts from rocks up to 2 feet in diameter. For larger rocks, up to 4 to 5 feet, cable net or heavier gauge high tensile strength wire mesh (0.157 inch, 4 mm) should be used. Alternatively, proprietary flexible rock fall barrier systems, attenuator systems, or retaining walls should be considered. Experience with the Rock fall Catchment Areas Design Guide study indicates that rock fall catch areas wider than 30 to 35 feet are not typically cost effective to construct, and additional barriers, fences or walls to gain ditch depth become more cost effective than wider ditches.

### **11.4.3 Construction Issues**

Construction of rock slopes near highways frequently must consider traffic control during blasting and scaling operations. The traffic control may include adjacent railroad facilities where trains are running next to the highway or other adjacent structures and facilities. The cost of traffic control for a busy highway can potentially result in a doubling of the project cost. Therefore, careful consideration of staging, detours, work zones, and blast-produced fly rock control must be done during design. It may even be necessary to choose another mitigation option than the preferred one because of these issues.

Environmental concerns in scenic highway corridors have made construction of rock slopes more difficult. Presplit whole half-casts that are visible after blasting may be regarded as a visual concern and a bid item may be needed to partially or completely remove them. This issue has been most notable in the Columbia River Gorge Scenic Corridor, and in a few USFS forest highways. Rock coloration has also been a concern and a bid item for Permeon, a rock coloration product, has been included on several projects contracts. In addition, sculpted shotcrete could be considered as a mitigation alternative for visual impacts on some slopes.

## 11.4.4 Blasting Consultant

A Blasting Consultant may need to be retained to assist a contractor in designing a safe blast if there are nearby structures, if the site is particularly challenging, or otherwise has the potential to result in undesired consequences. Guidelines for determining when a Blasting Consultant is needed are located on the ODOT website. ODOT keeps a list of preapproved blasting consultants and has a method of approving new blasting consultants and the HQ Geotechnical Group should be contacted.

## 11.4.5 Wire Mesh Slope Protection/ Cable Net Slope Protection

For draped wire mesh slope protection, the designer may choose either double twisted gabion wire mesh or high tensile strength wire mesh. These systems are typically either galvanized or PVC coated. Staining and powder coating of the system can address visual impacts associated with the mesh. Heavier gauge high tensile strength wire mesh is an alternative to cable net systems. Anchor spacing for Wire Mesh, Cable Net, and Post-Supported Wire Mesh Slope Protection are based on the weight of the mesh alone. Narrower spacing may be required where snow and ice loads will add a significant amount of stress to the anchors. Anchor embedment guidelines are provided on the standard details however, specific requirements should be developed on a site-specific basis.

The WashDOT research report, *Design Guidelines for Wire Mesh/Cable Net Slope Protection, WA-RD 612.1*, should be used to determine anchor spacing in snow/ice load situations. If mesh is use in a coastal environment, stainless steel fasteners and hardware or heavy galvanizing should be used to inhibit corrosion.

## 11.4.6 Rock Reinforcing Bolts and Rock Reinforcing Dowels

The designer must identify the installation area, size and strength of steel, pattern, or spacing, inclination, minimum length, and design loads of the bolts or dowels and this information must be included in the Geotechnical Report. Non-shrink cement grouts should be used for all permanent application of rock reinforcing bolts and dowels. Polyester resin or cement grout should only be considered for semi-permanent rock reinforcing dowels. Hollow bar anchors are becoming more common due to their relatively easy installation and ability to be installed in poor ground conditions. Mechanical anchorage bolts and non-shrink cement grout are included in the *ODOT Qualified Products List (QPL)*. The designer should refer to minimum rock strength requirements required by the manufacturer for mechanical anchorage bolts. Split set and bail set type anchorage systems are considered temporary or low stress installations and are not acceptable for use on ODOT projects.



### 11.4.7 Proprietary Flexible Rockfall Barrier Systems

High capacity rock fall net systems are available from two accepted manufacturers, GeoBrugg and Maccaferri. Full-scale tests on these systems have been performed by the manufacturers in accordance with European Technical Approval Guidelines (ETAN) 27. These guidelines were recommended for adoption by state DOT's in NCHRP Report 24-35 (2016). The systems are generally capable of withstanding impact kinetic energies up to 735 ft.-tons and can be constructed with breakaway post base connections and post heights up to 20 to 25 feet. Due to the proprietary nature of these systems, flexible rockfall barriers are typically procured using performance specifications that identify the design kinetic energy and roadway clear zones. These systems can be a viable alternative to high barriers and MSE walls in rock fall situations.

### 11.4.8 Pinned Cable and Wire Mesh Systems

Pinned cable and wire mesh systems are an effective rockfall mitigation alternative for mitigating rockfall where there is little or no catchment at grade and excavation is not an alternative. These systems can be designed as either passive or active. Passive systems do not apply a load to the slope and prevent rockfall by containing rocks behind the mesh. Examples of this approach include anchored cable nets. Active systems are installed in tension, which applied a normal load to the rock face and preventing rock fall from occurring. Pinned Tecco Mesh is an example of an active system. The designer must use the appropriate design approach and specifications associated with the intended mitigation.

### 11.4.9 Rock fall Attenuator Systems

Rock fall attenuator systems are a hybrid of drapery systems and flexible rock fall fences. They are typically designed to capture rock fall from sources substantially upslope of the roadway that are not practical to mitigate with drapery. The attenuator system attenuates the energy, suppresses the trajectory, and guides the rock to the base of the slope into the catchment area. A significant advantage to this system versus an upslope rock fall net system is that rock fall can be easily addressed by maintenance at ditch level.

The post-supported wire mesh slope protection included in ODOT Standard Details is an example of a low capacity attenuator system. This design should only be used for relatively small rock fall with modest trajectories and energies and its use confirmed through design. More robust attenuator systems are typically proprietary and procured using performance specifications. These designs should identify the design kinetic energy and location along the rock slope that the attenuator system should be placed.

## 11.5 Standard Details

[Standard Details](#) are normally used in the mitigation of rock fall hazards. These details are also found in the *Roadway Contract Plans Development Guide*. The following details are presented:

- Det 2200 - Cable Net Slope Protection
- Det 2201 - Wire Mesh/Cable Net Anchors

- Det 2202 - Shotcrete Slope
- Det 2203 - Wire Mesh Slope Protection
- Det 2204 - Barrier Mounted Rock Protection Screen
- Det 2205 - Post Supported Wire Mesh Slope Protection
- Det 2206 - Post Supported Wire Mesh Slope Protection
- Det 2207 – Post Supported Wire Mesh Slope Protection and Rock Protection Screen  
Anchor Details
- Det 2208 - Rock Protection Screen Behind Concrete Barrier or Guardrail
- Det 2209 - Rock Protection Screen Behind Concrete Barrier or Guardrail

## 11.6 Specifications

The location of Standard Specifications and Special Provisions for items pertaining to rock slopes and rock slope mitigation are listed in the next sections.

### 11.6.1 Blasting

Specifications for general excavation of rock slopes flatter than 0.75:1, where presplit (controlled blasting) of the backslope is not required, are located in *Section 00330.41(e) - Blasting of the Standard Specifications*.

Specifications for rock excavation where slopes are 0.75:1 or steeper are located in *Section 00335 - Blasting Methods and Protection of Excavation Back slopes of the Standard Specifications*. A per foot bid item quantity for Controlled Blast Holes is required if this specification is used.

Special Provisions for retaining a Blasting Consultant (see *Section 00335.44 Blasting Consultant*), Vibration Control (see *Section 00335.45 Vibration Control*), and Blasting Noise Control (see *Section 00335.46 Air blast and Noise Control*) are located in the Special Provisions section of the ODOT Specifications Webpage.

### 11.6.2 Rock slope Mitigation Methods

The following rock slope mitigation methods are located in a new section of the Standard Specifications, Section 00398 – Rock slope Stabilization and Reinforcement.

- Wire Mesh Slope Protection
- Post Supported Wire Mesh Slope Protection
- Rock Protection Screen Behind Barrier or Guardrail
- Rock Reinforcing Bolts/Rock Reinforcing Dowels
- Proprietary Flexible Rockfall Barrier System
- Pinned Wire Mesh

## 11.7 References

- Wyllie, D., and Mah, C., 1998, *Rock Slopes Reference Manual*, FHWA HI-99-007.
- Pierson, L., Gullixson, C., and Chassie, R., 2001, *Rock fall Catchment Area Design Guide*, FHWA Final Report SPR-3(032).
- Konya, C., and Walter, E., 2015, [Rock Blasting and Overbreak Control](#), 5th ed., FHWA-HI-92-001.
- Muhunthan, B. et.al, 2005, [Analysis and Design of Wire Mesh/Cable Net Slope Protection](#), WashDOT, Final Research Report WA-RD 612.1.
- Turner, A. K., and Schuster, R.L., 1996, *Landslides: Investigation and Mitigation*, TRB Special Report 247, National Academy Press.
- Brawner, C. O., 1993, *Manual of Practice on Rock fall Hazard Mitigation Methods*, FHWA, National Highway Institute Participant Workbook DTFH61-92-Z-00069.
- Post Tensioning Institute, 1996, *Recommendations for Prestressed Rock and Soil Anchors*, Post Tensioning Institute, Phoenix, Arizona.
- Jones, C., Higgins, J., and Andrew, R., 2000, "CRSP ver. 4.0", Colorado Rock fall Simulation Program, Colorado DOT Report CDOT-SYMB-CGS-99-1.
- Wyllie, Duncan C., and Mah, Christopher W., 2004, *Rock Slope Engineering: Civil and Mining*, 4<sup>th</sup> ed., Spon Press, NY, NY.

# Chapter 12 - Reserved



## Chapter Contents

Chapter 12 - Reserved.....	12-1
----------------------------	------

## **12.1 Reserved**

This chapter is reserved for future development.

# Chapter 13 - Seismic Design



## Chapter Contents

<b>Chapter 13 - Seismic Design .....</b>	<b>13-1</b>
13.1 General.....	13-4
13.1.1 Seismic Design Standards .....	13-4
13.1.2 Background .....	13-6
13.1.3 Responsibility of the Geotechnical Designer.....	13-7
13.2 Seismic Design Performance Requirements.....	13-7
13.2.1 New Bridges.....	13-7
13.2.2 Bridge Widening.....	13-10
13.2.3 Bridge Abutments and Retaining Walls .....	13-11
13.2.4 Bridge Approach Embankments, General Embankments and Cut Slopes.....	13-12
13.3 Ground Motion Parameters.....	13-12
13.3.1 Site Specific Probabilistic Seismic Hazard Analysis.....	13-13
13.3.2 Magnitude and PGA for Liquefaction Analysis .....	13-13
13.3.3 Deaggregation of Seismic Hazard .....	13-14
13.4 Site Characterization for Seismic Design.....	13-17
13.4.1 Subsurface Investigation for Seismic Design .....	13-17
13.5 Geotechnical Seismic Design Procedures .....	13-28
13.5.1 Design Ground Motion Data .....	13-31
13.5.2 Liquefaction Analysis .....	13-38
13.5.3 Slope Stability and Deformation Analysis.....	13-48
13.5.4 Settlement of Dry Sand.....	13-54

13.5.5 Liquefaction Effects on Structure Foundations..... 13-55  
 13.5.6 Mitigation Alternatives ..... 13-60  
 13.6 Input for Structural Design..... 13-62  
 13.6.1 Foundation Springs..... 13-62  
 13.7 References ..... 13-65  
 Appendix 13-A Flow chart for evaluation of liquefaction hazard and ground deformation at  
 bridge sites ..... 13-71  
 Appendix 13-B ODOT Liquefaction Mitigation Procedures..... 13-72

**List Of Tables**

Table 13-1 Values of Site Factor,  $F_{pga}$ , at Zero-Period on Acceleration Spectrum ..... 13-8  
 Table 13-2 Values of Site Factor,  $F_a$ , for Short-Period Range of Acceleration Spectrum ..... 13-9  
 Table 13-3 Values of Site Factor,  $F_v$ , for Long-Period Range of Acceleration Spectrum ..... 13-9  
 Table 13-4 Summary of site characterization needs and testing considerations for seismic design  
 (adapted from Sabatini, et al., 2002)..... 13-20  
 Table 13-5 Correlations for Estimating Initial Shear Modulus (SCDOT, 2010)..... 13-23

**List Of Figures**

Figure 13-1 Typical Source to Site distance definitions ..... 13-16  
 Figure 13-2 -Shear modulus reduction and damping ratio curves for sand (EPRI, 1993). ..... 13-24  
 Figure 13-3 Variation of  $G/G_{max}$  vs. cyclic shear strain for fine grained soils (redrafted from  
 Vucetic and Dobry, 1991). ..... 13-25  
 Figure 13-4 Equivalent viscous damping ratio vs. cyclic shear strain for fine grained soils  
 (redrafted from Vucetic and Dobry, 1991). ..... 13-25  
 Figure 13-5 Correlation between the Residual Undrained Strength Ratio,  $S_r/\sigma'_{vo}$  and equivalent  
 clean sand SPT blow count,  $(N_1)_{60-CS}$  (Idriss and Boulanger, 2007)..... 13-26  
 Figure 13-6 Correlation between Undrained Residual Strength Ratio ( $S_r/\sigma'_{vo}$ ) and Normalized  
 SPT Resistance ( $(N_1)_{60}$ ) (Olson and Johnson, 2008)..... 13-26  
 Figure 13-7 Variation of residual strength ratio with SPT resistance and initial vertical effective  
 stress using Kramer-Wang model (Kramer, 2008)..... 13-27  
 Figure 13-8 Correlation between the Undrained Residual Strength Ratio,  $S_r/\sigma'_{vo}$ , and  
 normalized CPT tip resistance,  $qc_1$  (Olson and Johnson, 2008)..... 13-27  
 Figure 13-9 General Geotechnical Seismic Design Procedures ..... 13-30  
 Figure 13-10 Magnitude Scaling Factors Derived by Various Investigators (redrafted from 1996  
 NCEER Workshop Summary Report) ..... 13-44  
 Figure 13-11 Post-liquefaction volumetric strain estimated using the Tokimatsu & Seed  
 procedure (redrafted from Tokimatsu and Seed, 1987). ..... 13-46

Figure 13-12 Post-liquefaction volumetric strain estimated using the Ishihara and Yoshimine procedure. (redrafted from Ishihara and Yoshimine, 1992). ..... 13-47

Figure 13-13 Newmark Sliding Block Concept for Slopes (Kavazanjian, et al. (2011)). ..... 13-52

Figure 13-14 p-multiplier (mp) vs. clean sand equivalent corrected blow count, (N1)60CS, from a variety of studies. (Ashford et al., 2012)..... 13-58

Figure 13-15 Extent of Ground Improvement for Liquefaction Mitigation..... 13-61

**List Of Equations**

---

Equation 13-1 ..... 13-41

Equation 13-2 ..... 13-57

Equation 13-3 ..... 13-63



## 13.1 General

This chapter describes ODOT's standards and policies regarding the geotechnical aspects of the seismic design of ODOT projects. The purpose is to provide geotechnical engineers and engineering geologists with specific seismic design guidance and recommendations not found in other standard design documents used for ODOT projects. Complete design procedures (equations, charts, graphs, etc.) are usually not provided unless necessary to supply, or supplement, specific design information, or if they are different from standards described in other references. This chapter also describes what seismic recommendations should typically be provided by the geotechnical engineer in the Geotechnical Report.

### 13.1.1 Seismic Design Standards

The seismic design of ODOT bridges shall follow methods described in the most current edition (including the latest interims) of the "AASHTO Guide Specifications for LRFD Seismic Bridge Design" (AASHTO, 2011), the "AASHTO LRFD Bridge Design Specifications" (AASHTO, 2014), the "ODOT Bridge Design Manual" (BDM) and the recommendations supplied in this chapter. Refer to the ODOT BDM for additional design criteria and guidance regarding the use of the AASHTO Guide Specifications on bridge projects. The term "AASHTO" as used in this chapter refers to AASHTO LRFD design methodology. For seismic design of new buildings the requirements prescribed by the Oregon Structural Specialty Code (Oregon Building Codes Division, 2014), with reference to the International Building Code (International Code Council, 2012), shall be used. Unless otherwise noted, the standards and policies described in this chapter supersede those described in the referenced documents.

In addition to these standards, the following document should be referenced for additional design guidance in seismic design for issues and areas not addressed in detail in the AASHTO specifications or this chapter:

*"LRFD Seismic Analysis and Design of Transportation Geotechnical Features and Structural Foundations"*, Geotechnical Engineering Circular No. 3. (Kavazanjian, et al. 2011).

This FHWA document provides design guidance on earthquake engineering fundamentals, seismic hazard analysis, ground motion characterization, site characterization, seismic site response analysis, seismic slope stability, liquefaction analysis, and soil-foundation-structure interaction for use in the seismic design of structure foundations and retaining walls.

Additional reference documents for use in design are as follows:

- NCHRP Report 611 (Anderson et. al., 2008): *"Seismic Analysis and Design of Retaining Walls, Buried Structures, Slopes, and Embankments"*, is a research project that developed analysis and design methods, and recommended load and resistance factor design (LRFD) specifications, for the seismic design of retaining walls, slopes, embankments, and buried structures. Example problems for the design of retaining walls, slopes and embankments, and buried structures using LRFD methods are included in the report.

- Report No. FHWA-NHI-11-075 (Kavazanjian et al, 2011): “*LRFD Seismic Analysis and Design of Transportation Geotechnical Features and Structural Foundations, Design Examples*”, is a supplement document to GEC-3 document (NHI Course #13094) containing useful examples problems demonstrating the use of LRFD seismic design principals in practice.
- NCHRP Report 472 (ATC-MCEER Joint Venture, 2002): “*Comprehensive Specifications for the Seismic Design of Bridges*”, is a report containing the findings of a study completed to develop recommended specifications for seismic design of highway bridges. The report covers topics including design earthquakes and performance objectives, foundation design, liquefaction hazard assessment and design, and seismic hazard representation.
- Oregon Department of Transportation, [Seismic web page](#)

This site provides the maps of 2014 USGS Probabilistic Seismic Hazard Analyses (PSHA) in the form of the Uniform Seismic Hazard, which reflects the contribution of all seismic sources in the region on the ground motion parameters. The ground motion parameters (Peak Ground Acceleration (PGA), and acceleration response spectral ordinates at 0.2 and 1.0 seconds for Site Class B rock for 500-year, 1,000-year return periods, specified as a percentage probability of exceedance in a given exposure interval, in years. This website also provides the seismic hazard maps for the Cascadia Subduction Zone Earthquake (CSZE).
- Report No. FHWA-NHI-11-030 (Marsh et. al., 2011): “*LRFD Seismic Analysis and Design of Bridges, Reference Manual*”, is the reference manual for a comprehensive NHI training course that addresses the requirements and recommendations of the seismic provisions in both the AASHTO LRFD Bridge Design Specifications and the AASHTO Guide Specifications for LRFD Seismic Bridge Design. Topics include force- and displacement-based design methodologies, the principles of capacity demand, methods for modeling and analyzing bridges subjected to earthquake motions, base isolation design and seismic retrofit strategies.
- Report No. FHWA-HRT-06-032 (Buckle et al., 2006): “*Seismic Retrofitting Manual for Highway Structures: Part 1 – Bridges.*”
- United States Geological Survey; National Seismic Hazard Mapping Project.
- In the past the USGS National Seismic Hazard Maps website has been used for characterizing the seismic hazard for a specific site. However, in an effort to make the 2014 USGS National Seismic Hazard Maps static the maps will be hosted at a different location which is not known at this time.
- [WSDOT Geotechnical Design Manual, M46-03.11, 2015.](#)

The following two ODOT documents are available on the ODOT Geo-Environmental website for general reference. Note that aspects of the analyses procedures outlined in these archival documents have subsequently been updated and refined. The example problems included in these documents, demonstrating the application of selected seismic design procedures, are

considered useful for general guidance; however, practitioners should make use of the most current procedures.

- *“Assessment and Mitigation of Liquefaction Hazards to Bridge Approach Embankments in Oregon”*, Dickenson, S., et al., Oregon State University, Department of Civil, Construction and Environmental Engineering, SPR Project 361, November, 2002.
- *“Recommended Guidelines For Liquefaction Evaluations Using Ground Motions From Probabilistic Seismic Hazard Analysis”*, Dickenson, S., Oregon State University, Department of Civil, Construction and Environmental Engineering, Report to ODOT, June, 2005.

## **13.1.2 Background**

In light of the complexity of seismic design of transportation facilities, continuous enhancements to analytical and empirical methods of evaluation are being made as more field performance data is collected and research advances the state of knowledge. New methods of analysis and design are continuously being developed and therefore it is considered prudent to not be overly prescriptive in defining specific design methods for use in the seismic design process. However, a standard of practice needs to be established within the geotechnical community regarding minimum required design criteria for seismic design. It is well recognized that these standards are subject to change in the future as a result of further research and studies. This chapter will be updated as more information is obtained, new design codes are approved and better design methods become available.

Significant engineering judgment is required throughout the entire seismic design process. The recommendations provided herein assume the geotechnical designer has a sound education and background in basic earthquake engineering principles. These recommendations are not intended to be construed as complete or absolute. Each project is different and requires important decisions and judgments be made at key stages throughout the design process. The applicability of these recommended procedures should be continually evaluated throughout the design process. Peer review may be required to assist the design team in various aspects of the seismic hazard and earthquake-resistant design process.

Earthquakes often result in large axial and lateral loads being transferred from above ground structures into the structure foundations. At the same time, foundation soils may liquefy, resulting in a loss of soil strength and foundation capacity. Under this extreme event condition it is common practice to allow the foundations to be loaded up to the nominal (ultimate) foundation resistances (allowing resistance factors as high as 1.0). This design practice requires an increased emphasis on quality control during the construction of bridge foundations since we are now often relying on the full, un-factored nominal resistance of each foundation element to support the bridge during the design seismic event.

In addition to seismic foundation analysis, seismic structural design also involves an analysis of the soil-structure interaction between foundation materials and foundation structure elements. Soil-structure interaction is typically performed in bridge design by modeling the foundation elements using equivalent linear springs. Some of the recommendations presented herein relate

to bridge foundation modeling requirements and the geotechnical information the structural designer needs in order to do this analysis. Refer to *Section 1.10.4* of the [“ODOT Bridge Design Manual”](#) (BDM) for more information on bridge foundation modeling procedures.

### 13.1.3 Responsibility of the Geotechnical Designer

The geotechnical designer is responsible for providing geotechnical/seismic recommendations and input parameters to the structural engineers for their use in design of the transportation infrastructure. Specific elements to be addressed by the geotechnical designer include the following: design ground motion parameters, dynamic site response, geotechnical design parameters and geologic hazards. The geotechnical designer is also responsible for providing input for evaluation of soil-structure interaction (foundation response to seismic loading), earthquake induced earth pressures on retaining walls, and an assessment of the impacts of geologic hazards on the structures. Refer to [Chapter 19](#) for geotechnical seismic design reporting requirements.

The seismic geologic hazards to be evaluated include fault rupture, liquefaction, ground failure including flow slides and lateral spreading, ground settlement, and instability of natural slopes and earth structures. The seismic performance of tunnels is a specialized area of geotechnical earthquake engineering not specifically addressed in this guidance document; however, the ground motion parameters determined in the seismic hazard analyses outlined herein may form the basis for tunnel stability analyses (e.g., rock fall adjacent to portals and in unlined tunnels, performance of tunnel lining). The risk associated with seismic geologic hazards shall be evaluated by the geotechnical designer following the methods described in this chapter.

## 13.2 Seismic Design Performance Requirements

### 13.2.1 New Bridges

Design new bridges on or West of US97 for a two-level seismic design criteria; Life Safety and Operational. Bridges east of US97 will be designed using the Life Safety seismic design criteria. Seismic Design Criteria for Life Safety and Operational performance are described below.

The ODOT Seismic website, listed below, should be referenced to obtain the earthquake hazards and design tools associated with the Life Safety and Operational design criteria.

<https://www.oregon.gov/ODOT/Bridge/Pages/Seismic.aspx>

#### **“Life-Safety” Design Criteria:**

Under this level of shaking, the bridge and approach structures, foundation and approach fills must be able to withstand the design forces and displacements without collapse of any portion of the structure and also be consistent with the Life Safety seismic design criteria described below and in the current ODOT BDM. In general, bridges that are properly designed and detailed for seismic loads can accommodate relatively large deflections without the danger of collapse.

If large embankment displacements (lateral spread) or overall slope failure of the end fills are predicted, the impacts on the bridge end bent, abutment walls and interior piers should be evaluated to see if the impacts could potentially result in collapse of any part of the structure. Slopes adjacent to a bridge or tunnel should be evaluated if their failure could result in collapse of a portion or all of the structure.

Report ground motions having an average return period of 1000 years (7% probability of exceedance in 75 years). Ground motion parameters shall be based on the 2014 USGS seismic hazard maps (Peterson, M.D., et. al., 2014). The probabilistic hazard maps for the 1,000-year and 500-year return periods are available at ODOT Seismic website listed above.

To aid in consistency and efficiency, Bridge Section has developed an Excel application, ODOT\_ARS.v. 2014.16, for constructing the probabilistic design response spectrum using the general procedure (three-point curve) for the 2014 data. Inputs for the application include latitude, longitude, and site class. The Excel application has been released to incorporate the updated site coefficients associated with the 2014 hazard maps, provided below and the necessary inputs to generate a three point response spectra. The tables below replace Tables 3.4.2.3-1, and 3.4.2.3-2 in the AASHTO Guide Specifications for LRFD Seismic Bridge Design.

*Replace AASHTO Guide Spec Table 3.4.2.3-1 with tables 13.1 and 13.2:*

**Table 13-1 Values of Site Factor,  $F_{pga}$ , at Zero-Period on Acceleration Spectrum**

Site Class	Mapped Peak Ground Acceleration Coefficient (PGA) <sup>1</sup>					
	PGA ≤ 0.1	PGA = 0.2	PGA = 0.3	PGA = 0.4	PGA = 0.5	PGA ≥ 0.6
A	0.8	0.8	0.8	0.8	0.8	0.8
B	0.9	0.9	0.9	0.9	0.9	0.9
C	1.3	1.2	1.2	1.2	1.2	1.2
D	1.6	1.4	1.3	1.2	1.1	1.1
E	2.4	1.9	1.6	1.4	1.2	1.1
F <sup>2</sup>	*	*	*	*	*	*

**Table 13-2 Values of Site Factor,  $F_a$ , for Short-Period Range of Acceleration Spectrum**

Site Class	Mapped Spectral Acceleration Coefficient at Period 0.2 sec ( $S_s$ ) <sup>1</sup>					
	$S_s \leq 0.25$	$S_s = 0.5$	$S_s = 0.75$	$S_s = 1.0$	$S_s = 1.25$	$S_s \geq 1.5$
A	0.8	0.8	0.8	0.8	0.8	0.8
B	0.9	0.9	0.9	0.9	0.9	0.9
C	1.3	1.3	1.2	1.2	1.2	1.2
D	1.6	1.4	1.2	1.1	1.0	1.0
E <sup>3</sup>	2.4	1.7	1.3	*	*	*
F <sup>2</sup>	*	*	*	*	*	*

Replace AASHTO Guide Spec Table 3.4.2.3-2 with following table:

**Table 13-3 Values of Site Factor,  $F_v$ , for Long-Period Range of Acceleration Spectrum**

Site Class	Mapped Spectral Response Acceleration Coefficient at Period 1.0 sec ( $S_1$ ) <sup>1</sup>					
	$S_1 \leq 0.1$	$S_1 = 0.2$	$S_1 = 0.3$	$S_1 = 0.4$	$S_1 = 0.5$	$S_1 \geq 0.6$
A	0.8	0.8	0.8	0.8	0.8	0.8
B	0.8	0.8	0.8	0.8	0.8	0.8
C	1.5	1.5	1.5	1.5	1.5	1.4
D <sup>3</sup>	2.4	2.2 <sup>3</sup>	2.0 <sup>3</sup>	1.9 <sup>3</sup>	1.8 <sup>3</sup>	1.7 <sup>3</sup>
E <sup>3</sup>	4.2	3.3 <sup>3</sup>	2.8 <sup>3</sup>	2.4 <sup>3</sup>	2.2 <sup>3</sup>	2.0 <sup>3</sup>
F <sup>2</sup>	*	*	*	*	*	*

Notes:

<sup>1</sup> – Use straight-line interpolation for intermediate values of PGA,  $S_s$ , and  $S_1$ .

<sup>2</sup> – Perform a site-specific geotechnical investigation and dynamic site response analysis for all multi-span bridges in Site Class F.

<sup>3</sup> –A Consider a ground motion hazard analysis and/or dynamic site response analysis for multi-span structures.

**“Operational” Design Criteria:**

In addition to the “Life Safety” performance design criteria, all bridges on and west of US Hwy 97 shall be designed to remain in service following a level of ground shaking associated with a full-rupture Cascadia Subduction Zone Earthquake (CSZE). Seismic hazard maps and spectral accelerations of CSZE have been developed based on the full-rupture CSZE event. A summary of this work is provided the 2016 final report to ODOT titled “*Impact of Cascadia Subduction Zone Earthquake on the Evaluation Criteria of Bridges*”. These maps are available on the [ODOT Seismic](#) web page. Also available on the web page, is a program developed by Portland State University (PSU) to generate a deterministic (eighteen points) response spectra. A link to PSU’s program is located on the ODOT Seismic web page and is titled [Cascadia Subduction Zone](#).

For the Operational performance level, bridges and approach fills are designed to remain in service shortly after the event (after the bridge has been properly inspected) to provide access for emergency vehicles. Some structural damage is anticipated but the damage should be repairable and the bridge should be able to carry emergency vehicles immediately following the earthquake. This holds true for the approach fills leading up to the bridge.

Approach fill settlement and lateral displacements should be minimal to provide for immediate emergency vehicle access for at least one travel lane. For mitigation purposes approach fills are defined as shown in [Figure 13-15](#). As a general rule of thumb, an estimated lateral embankment displacement of up to 1 foot is considered acceptable in many cases as long as the “operational” performance criteria described above can be met and the structure foundations are adequately designed to withstand the soil loads resulting from the lateral displacements. Vertical settlements on the order of 6” to 12” may be acceptable depending on the roadway geometry, anticipated performance of the bridge end panels and the ability of bridge foundation elements to withstand any imposed downdrag loads. Bridge end panels are required on all state highway bridge projects (per *BDM*) and should be evaluated for their ability to withstand the anticipated embankment displacements and settlement and still provide the required level of performance. These displacement criteria are to serve as general guidelines only and engineering judgment is required to determine the final amounts of acceptable displacement that will meet the desired criteria. It should be noted that these estimated displacements are not at all precise values and may easily vary by factors of 2 to 3 depending on the analysis method(s) used. The amounts of allowable vertical and horizontal displacements should be decided on a case-by-case basis, based on discussions and consensus between the bridge designer and the geotechnical designer and other appropriate project personnel.

In addition to bridge and approach fill performance, embankments through which cut-and-cover tunnels are constructed should be designed to remain stable during the design seismic event because of the potential for damage or possible collapse of the structure should they fail.

Approach embankments and structure foundations should be designed to meet the above performance requirements. Unstable slopes such as active or potential landslides and other seismic hazards such as liquefaction, lateral spread, post-earthquake settlement and downdrag may require mitigation measures to ensure that the structure meets these performance requirements. Refer to [Chapter 14](#) for guidance on ground improvement techniques to use in mitigating these hazards.

## **13.2.2 Bridge Widening**

For the case where an existing bridge is to be widened and new foundation support is required, the seismic foundation designs for the widened bridge should be designed using the same seismic design criteria as “New Bridges”. Consult with the bridge designer to determine the design and performance requirements for all new foundations required for bridge widening projects and/or the need for any Phase 2 retrofit design work.

If Phase 2 foundation retrofit or liquefaction mitigation is necessary to meet the performance criteria, these designs shall be reviewed and approved by the HQ Bridge Section.

### 13.2.3 Bridge Abutments and Retaining Walls

Seismic design performance objectives for bridge abutments shall be consistent with the design requirements for the supported bridge. Seismic design performance objectives for retaining walls depend on the function of the retaining wall and the potential consequences of failure. There are four retaining wall categories, as defined in [Chapter 16](#). The seismic design performance objectives for these four categories are listed below. Refer to AASHTO, (2014) Article 11.5.4 for seismic design requirements for retaining walls under the Extreme Event Limit State condition. The Extreme Event I “no analysis” provisions of AASHTO Section 11 shall not apply to “Bridge Abutment Walls” or “Bridge Retaining Walls”.

Retaining walls and bridge abutments should not be built on or near landslides or other areas that are marginally stable under static conditions. However, if site conditions, project constraints (cost), prohibit an effective technical alternative, the local Region Tech Center will evaluate, on a case-by-case basis, the possible placement of these structures in these locations, as well as requirements for global (overall) instability of the landslide during the design seismic event.

- **Bridge Abutments**: Bridge Abutments are considered to be part of the bridge, and shall meet the seismic design performance objectives for the bridge see [Section 7.2.1](#).
- **Bridge Retaining Walls**: Design all Bridge Retaining Walls for 1000-year return period ground motions under the “Life Safety” bridge criteria. Under this level of shaking, the Bridge Retaining Wall must be able to withstand seismic forces and displacements without failure of any part of the wall or collapse of any part of the bridge which it supports. Bridge Retaining Walls shall be designed for overall stability under these seismic loading conditions, including anticipated displacements associated with liquefaction. Mitigation to achieve overall stability may be required.

In addition, design all Bridge Retaining Walls for the ground motions described under the “Operational” bridge criteria. Under this level of shaking, Bridge Retaining Wall movement must not result in unacceptable performance of the bridge or bridge approach fill, as described under the “Operational” criteria in [Section 7.2.1](#).

- **Highway Retaining Walls**: Highway Retaining Walls should be designed for 1000-year return period ground motions unless the “No Analysis” option, as described in Article 11.5.4 of AASHTO (2014), is applicable. Under this level of shaking, the Highway Retaining Wall must be able to withstand seismic forces and displacements without failure of any part of the Highway Retaining Wall. Highway Retaining Walls shall be designed for overall stability under these seismic loading conditions, including anticipated displacements associated with liquefaction. Mitigation to achieve overall stability may be required
- **Minor Retaining Walls**: Minor Retaining Wall systems have no seismic design requirements.



The policy to design all Highway Retaining Walls to meet overall stability requirements for seismic design may not be practical at all wall locations. Where it is not practical to design a Highway Retaining Wall for overall stability under seismic loading, and where a failure of this type would not endanger the public, impede emergency and response vehicles along essential lifelines, or have an adverse impact on another structure, the local Region Tech Center should evaluate practicable alternatives for improving the seismic resistance and performance of the retaining wall.

### 13.2.4 Bridge Approach Embankments, General Embankments and Cut Slopes

Bridge approach embankments should be evaluated for seismic slope stability and settlement in all areas where the ground surface acceleration coefficient ( $A_s$ ) is  $\geq 0.15g$ , especially if they are relied upon to provide passive soil resistance behind the abutment (Earthquake-Resisting System). Bridge approach embankments (with or without retaining walls) should be designed to meet the operational and life safety performance requirements described in [Section 7.2.1](#) and in accordance with all other applicable sections of this chapter.

Cut slopes, fill slopes, and embankments that are not bridge approach embankments are generally not evaluated for seismic instability unless they directly affect a bridge, highway retaining wall or other structure. Seismic instability associated with routine cuts and fills are typically not mitigated due to the high cost of applying such a design policy uniformly to all slopes statewide. If failure and displacement of existing slopes, embankments or cut slopes, due to seismic loading, could adversely impact an adjacent structure or facility, these areas should be considered for stabilization. Such impacts should be evaluated in terms of meeting the performance criteria.

## 13.3 Ground Motion Parameters

The ground motion parameters for the Life Safety design criteria are based on the 2014 USGS National Seismic Hazard Mapping Project. These maps provide the results of probabilistic seismic hazard analysis (PSHA) at the regional scale. Ground motion maps and design parameters for the Life Safety (1000-year PSHA) design criteria are available on the ODOT Seismic web page. The designer should review the basis of these hazard maps and have a thorough understanding of the data they represent and the methods used for their development.

The USGS Open-File Report 2014-1091 (Petersen et al., 2014) should be referenced for important information on the development of these seismic hazard maps.

The seismic hazard maps on the ODOT Seismic web page provide Peak Ground Acceleration (PGA), 0.20 sec. and 1.0 sec. spectral accelerations scaled in contour intervals of 0.01g. The PGA and spectral accelerations can be obtained by entering the latitude and longitude of the site and the desired probability of exceedance (i.e., 7% in 75 years for the 1000 year return event). It should be noted that the PGA obtained from these maps is actually the Peak "Bedrock"

Acceleration (i.e., Site Class B), and does not include, or take into account, any local soil amplification effects. See [Section 7.5.1](#) for the development of design ground motion data.

The ground motion parameters for the Operational design criteria are based on the report titled “Impact of Cascadia Subduction Zone Earthquake on the Evaluation Criteria of Bridges” by Portland State University. The Operational design criteria maps are the result using three different full rupture locations and depths with associated moment magnitude values (Chen, Frankel and Peterson 2014) and four weighted ground motion prediction equations (Atkinson & Boore 2003, Atkinson & Macias 2009, Zhao et. al 2006, and BC Hydro 2012). The ground motion parameter maps for the CSZE scenario are available on the ODOT Seismic web page. The designer should review the basis of these hazard maps and have a thorough understanding of the data they represent and the methods used for their development.

### 13.3.1 Site Specific Probabilistic Seismic Hazard Analysis

Ground motion parameters are also sometimes determined from a site specific Probabilistic Seismic Hazard Analysis (PSHA). A site specific probabilistic hazard analysis focuses on the spatial and temporal occurrence of earthquakes, and evaluates all of the possible earthquake sources contributing to the seismic hazard at a site with the purpose of developing ground motion data consistent with a specified uniform hazard level. The analysis takes into account all seismic sources that may affect the site and quantifies the uncertainties associated with the seismic hazard, including the location of the source, extent and geometry, maximum earthquake magnitudes, rate of seismicity, and estimated ground-motion parameters. The result of the analysis is a uniform hazard acceleration response spectrum that is based on a specified uniform hazard level or probability of exceedance within a specified time period (i.e., 7% probability of exceedance in 75 years). The PSHA is usually performed to yield ground motion parameters for bedrock (Site Class B) sites. The influence of the soil deposits at the site on the ground motion characteristics is subsequently evaluated using the results of the PSHA for bedrock conditions. The bedrock response spectra developed from the probabilistic hazard analysis can also be used as the basis for matching or scaling time histories for use in a site-specific ground response analysis.

A site specific probabilistic hazard analysis is typically not performed on routine ODOT projects. If such an analysis is desired for the design of ODOT bridge projects the HQ Bridge Section must approve the justification and procedures for conducting the analysis and the analysis must be reviewed by an independent source approved by the HQ Bridge Section. Review and approval of all PSHAs will be coordinated with the region geotechnical engineer.

### 13.3.2 Magnitude and PGA for Liquefaction Analysis

Earthquake engineering evaluations that address repeated (cyclic) loading and failure of soils must include estimates of the intensity and duration of the earthquake motions. In soils, liquefaction and cyclic degradation of soil stiffness/strength represent fatigue failures that often

impact bridge structures. In practice-oriented liquefaction analysis, the intensity of the cyclic loading is related to the PGA and/or cyclic stress ratio, and the duration of the motions is correlated to the magnitude of the causative event. The PGA and magnitude values selected for the analysis should represent realistic ground motions associated with specific, credible scenario earthquakes. The PGA values obtained from the USGS web site represent the “mean” values of all of the sources contributing to the hazard at the site for a particular recurrence interval. These “mean” PGA values should not typically be used for liquefaction analysis unless the ground motions at the site are dominated by a single source, as demonstrated in the PSHA deaggregation. Otherwise, the “mean” PGA values may not represent realistic ground motions resulting from known sources affecting the site. Additionally, the mean magnitude provided by PSHA should not be used as the causative event as this often averages the magnitude of large Cascadia Subduction Zone earthquakes and the magnitude of the smaller, local crustal events with a resulting magnitude that is not representative of any seismic source in the region. For this reason the modal event(s), designated as Magnitude and Distance (M-R) pairs, should typically be evaluated individually along with other M-R pairs that contribute significantly to the hazard.

### 13.3.3 Deaggregation of Seismic Hazard

For evaluation of the seismic hazard at sites using uniform hazard-based ground motions a deaggregation of the total seismic hazard should be performed to find the principal individual sources contributing to the seismic hazard at the site. The relative contribution of all considered sources, in terms of magnitude and distance, on PGA and on spectral accelerations can be readily evaluated using the results of the USGS seismic hazard mapping tools and deaggregation capabilities available through the USGS seismic hazard web site. In general, sources that contribute more than about 5% to the hazard should be considered for evaluation. However, sources that contribute less than 5% may also be sources to consider since they may still significantly affect the liquefaction analysis or influence portions of the site’s response spectra.

It is recommended that the relative contributions of all of the following sources be considered when performing liquefaction and ground deformation hazards:

1. Cascadia Subduction Zone – mega-thrust earthquakes,
2. Deep, Intraslab Benioff Zone earthquakes such as the 1949 and 1965 Puget Sound, and 2001 Nisqually earthquakes,
3. Shallow crustal earthquakes associated with mapped faults,
4. Regional background seismicity and ‘randomly’ occurring earthquakes that are not associated with mapped faults (gridded seismicity).

A deaggregation of the seismic hazard will provide the mean and modal values of Magnitude (M) and Distance (R) and also a table of M-R pairs associated with each source contributing to the hazard at the site. The mean deaggregation provides the weighted mean values of M and R for all sources that contribute to the hazard. The modal value(s) yields the M and R pair(s) having the largest contribution in the hazard deaggregation of each grid location. The modal

pairs represent the primary sources that should be considered in subsequent liquefaction and ground hazard analysis. For areas in the state where there are more than one significant seismic source the modal values are much more representative of the primary sources, and mean values of M and R are not recommended for use in liquefaction hazard analyses. In some areas of the state where the seismic hazard is derived mostly from a single primary source the mean values may be very representative of the site. In addition to consideration of mean and modal pairs, other individual M-R pairs listed in the deaggregation table that represent significant contributions to the hazard may be considered to supplement the modal (or mean) pairs. Sound engineering judgment is required throughout this process to decide which, if any, of these additional M-R pairs warrant consideration.

The M-R pairs selected from this process represent the primary sources and can then be utilized with ground motion prediction equations (GMPEs) to obtain bedrock PGA values at the site. It is recommended that more than one GMPE be used to estimate ground motion parameters for each of the primary seismic sources in Oregon (i.e., Cascadia Subduction Zone events, and shallow crustal events). The use of three to four GMPEs is common in practice.

In order to be consistent with the 2014 USGS seismic hazard maps, the same GMPEs and weighting factors that were used in developing the 2014 USGS seismic hazard maps would need to be used. Refer to the USGS Open-File Report 2014-1091 (Petersen et. al., 2014) for important information on how these GMPEs were used in developing the 2014 USGS Seismic Hazard maps.

The source distances for the subduction zone events reported from the USGS deaggregation web site are the closest distances to the fault or slab ( $R_{rup}$ ).

There are various definitions of the source-to-site distance to faults, depending on the GMPE selected. The source-to-site distance used in any given prediction calculation should be consistent with the source-to-site distance definition described in the documentation for that particular GMPE.

[Figure 13-1](#) depicts most of the typical distance definitions used in these prediction equations.

Figure 13-1 Typical Source to Site distance definitions

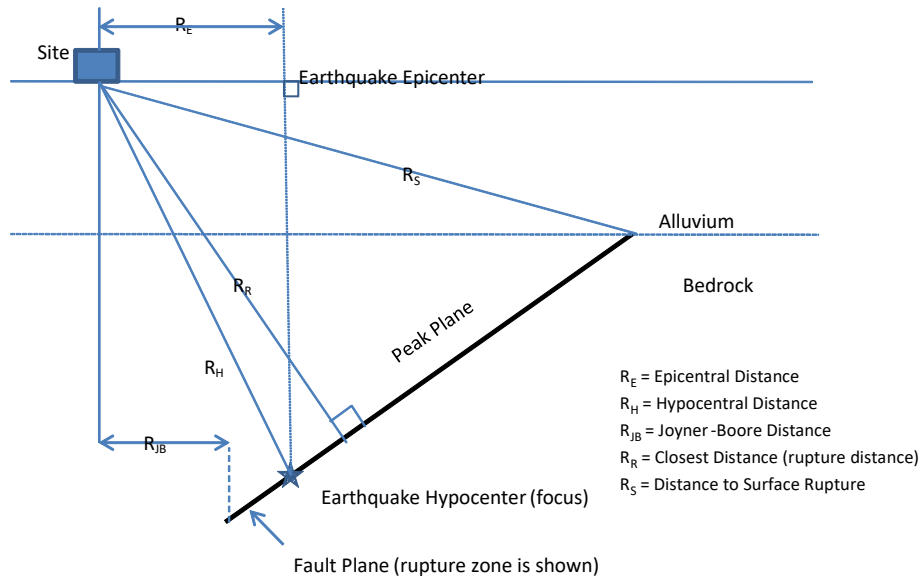

It is important to note that the ground motion values ( $PGA$ ,  $S_{0.2}$ ,  $S_{1.0}$ ) obtained for the primary M-R pairs obtained in this fashion will not likely be the same as the “mean” values developed for the Uniform Seismic Hazard (USH), which are used as the basis for structural analysis. Also, it is likely that the average value of a specific ground motion parameter obtained for the principal M-R pairs will also vary from the mean value provided by the USGS USH. The difference will reflect the number M-R pairs considered and the relative contributions of the sources to the overall hazard.

This deaggregation process will likely yield more than one M-R pair, and therefore more than one magnitude and peak ground acceleration, for liquefaction analysis in some areas of the state where the hazard is dominated by two or more seismic sources. In most of western Oregon, this will include both shallow crustal sources and the Cascadia Subduction Zone. In this case, each M-R (i.e., M-PGA) pair should be evaluated individually in a liquefaction analysis. If liquefaction is estimated for any given M-PGA pair, the evaluation of that pair is continued through the slope stability and lateral deformation evaluation processes.

In some areas in the state where the seismic hazard is dominated by a single source, such as the Cascadia Subduction Zone along parts of the Oregon coast, a single pair of M-R values (largest magnitude (M) and closest distance (R)) may be appropriate for defining and assessing the worst case liquefaction condition. In this area of the state, where the seismic hazard is dominated by the CSZ, the PGA calculated from the M-R pair for the 1000-yr return event (Life Safety criteria) may be roughly equivalent to the PGA obtained from the deterministic CSZ hazard maps, used for the Operational performance level. In that case the larger PGA value of

the two should be used in the liquefaction (and subsequent) analysis for both the Life Safety evaluations.

Refer to Dickenson (2005), for a practice-oriented approach for incorporating deaggregation results into liquefaction hazard assessment. A simplified approach applying the results of the deaggregation process, and examples for several locations in Oregon, is provided. This document is provided as an example and not intended to be a standard procedure or guideline.

## **13.4 Site Characterization for Seismic Design**

The geotechnical site investigation should identify and characterize the subsurface conditions and all geologic hazards that may affect the seismic analysis and design of the proposed structures or features. The goal of the site characterization for seismic design is to develop the subsurface profile and soil property information needed for seismic analyses. The geotechnical designer should review and discuss the project objectives with the project engineering geologist and the structural designer, as seismic design is a cooperative effort between the geotechnical and structural engineering disciplines. The geotechnical designer should do the following as a minimum:

- Identify potential geologic hazards, areas of concern (e.g., deep soft soils or liquefiable soils), and potential variability of local geology,
- Identify engineering analyses to be performed (e.g., ground response analysis, liquefaction susceptibility, lateral spreading/slope stability assessments, seismic-induced settlement/downdrag, dynamic earth pressures),
- Identify engineering properties required for these analyses,
- Determine methods to obtain the required design parameters and assess the validity of such methods for the soil and rock material types.

Develop an integrated investigation of in-situ testing, soil sampling, and laboratory testing. This includes determining the number of tests/samples needed and appropriate locations to obtain them.

### **13.4.1 Subsurface Investigation for Seismic Design**

Refer to Section 7.0 of AASHTO (2014), for guidance regarding subsurface investigation and site characterization for seismic foundation design. With the possible exception of geophysical explorations associated with obtaining seismic shear wave velocities in soil and rock units, the subsurface data required for seismic design is typically obtained concurrently with the data required for static design of the project (i.e., additional exploration for seismic design over and above what is required for foundation design is typically not necessary). However, the exploration program may need to be adjusted to obtain the necessary parameters for seismic design. For example, the use of the seismic cone penetration test, SCPT, is recommended in order to supplement tip resistance and friction data with shear wave velocity. Also, for Site

Class determination, subsurface investigations must extend to a depth of at least 100 feet unless bedrock is encountered before reaching that depth.

The selection of field drilling equipment and sampling methods will reflect the goals of the investigation. If liquefaction potential is a significant issue, mud rotary drilling with SPT sampling, combined with seismic piezocone penetrometer testing, are the preferred methods of investigation. The SPT methods described in ASTM D1586-11, to obtain the best quality SPT results for use in liquefiable soils. While mud-rotary drilling methods are preferred, hollow-stem auger (HSA) drilling may be utilized for SPT sampling and testing if precautionary measures are taken. Soil heaving and disturbance in HSA borings can lead to unreliable SPT “N” values. Therefore care must be taken if using HSA methods to maintain an adequate water head in the boring at all times and to use drilling techniques that minimize soil disturbance. Non-standard samplers shall not be used to collect data used in liquefaction analysis and mitigation design.

In addition to standard subsurface investigation methods, the following equipment calibration, soil testing, and/or sampling should be considered depending upon site conditions.

- **SPT Hammer Energy:** This value (usually termed hammer efficiency) should be noted on the boring logs or in the Geotechnical Report. The hammer efficiency should be obtained from the hammer manufacturer, preferably through field testing of the hammer system used to conduct the test. This is needed to determine the hammer energy correction factor,  $C_{er}$ , for liquefaction analysis.
- **Soil Samples for Gradation Testing:** Used for determining the amount (percentage) of fines in the soil for liquefaction analysis. Also useful for scour estimates.
- **Undisturbed Samples:** Laboratory testing for parameters such as  $S_u$ ,  $e_{50}$ ,  $E$ ,  $G$ ,  $OCR$ , Cyclic Direct Simple Shear and other parameters for both foundation modeling and seismic design.
- **Shear Wave Velocity Measurements:** For use in determining soil Site Class. Also used to develop a shear wave velocity profile of the soil column and to obtain low strain shear modulus values to use in analyses such as dynamic soil response.
- **Seismic Piezocone Penetrometer:** For use in determining soil Site Class. Also used to develop a shear wave velocity profile and obtain low strain shear modulus values to use in a ground response analysis.
- **Piezocone Penetrometer Test:** Used for liquefaction analysis and is even preferred in some locations due to potential difficulties in obtaining good quality SPT results. Pore pressure measurements and other parameters can be obtained for use in foundation design and modeling. Also useful in establishing the pre-construction subsurface soil conditions prior to conducting ground improvement techniques and the post-construction condition after ground improvement.

- **Depth to Bedrock:** If a ground response analysis is to be performed, the depth to bedrock must be known or reasonably estimated based on local data. “Bedrock” material for this purpose is defined as a material unit with a shear wave velocity of at least 2500 ft./sec.
- **Pressuremeter Testing:** For development of p-y curves if soils cannot be adequately characterized using the default relationships supplied in the LPILE, GROUP, DFSAP or other soil-structure interaction programs. Testing is typically performed in soft clays, organic soils, very soft or decomposed rock and for unusual soil or rock materials. The shear modulus,  $G$ , for shallow foundation modeling and design can also be obtained.

Table 13-4 provides a summary of site characterization needs and testing considerations for geotechnical/seismic design.



**Table 13-4 Summary of site characterization needs and testing considerations for seismic design (adapted from Sabatini, et al., 2002)**

Geotechnical Issues	Engineering Evaluations	Required Information For Analyses	Field Testing	Laboratory Testing
Site Response	<ul style="list-style-type: none"> <li>• source characterization and attenuation</li> <li>• site response spectra</li> <li>• time history</li> </ul>	<ul style="list-style-type: none"> <li>• subsurface profile (soil, groundwater, depth to rock)</li> <li>• shear wave velocity</li> <li>• bulk shear modulus for low strains</li> <li>• relationship of shear modulus with increasing shear strain</li> <li>• equivalent viscous damping ratio with increasing shear strain</li> <li>• Poisson’s ratio</li> <li>• unit weight</li> <li>• relative density</li> <li>• seismicity (PGA, design earthquakes)</li> </ul>	<ul style="list-style-type: none"> <li>• SPT</li> <li>• CPT</li> <li>• seismic one</li> <li>• geophysical testing (shear wave velocity)</li> <li>• piezometer</li> </ul>	<ul style="list-style-type: none"> <li>• cyclic triaxial tests</li> <li>• Atterberg Limits</li> <li>• specific gravity</li> <li>• moisture content</li> <li>• unit weight</li> <li>• resonant column</li> <li>• cyclic direct simple shear test</li> <li>• torsional simple shear test</li> </ul>
Geologic Hazards Evaluation (e.g. liquefaction, lateral spreading, slope stability)	<ul style="list-style-type: none"> <li>• liquefaction susceptibility</li> <li>• liquefaction induced settlement</li> <li>• settlement of dry sands</li> <li>• lateral spreading</li> <li>• slope stability and deformations</li> </ul>	<ul style="list-style-type: none"> <li>• subsurface profile (soil, groundwater, rock)</li> <li>• shear strength (peak and residual)</li> <li>• unit weights</li> <li>• grain size distribution</li> <li>• plasticity characteristics</li> <li>• relative density</li> </ul>	<ul style="list-style-type: none"> <li>• SPT</li> <li>• CPT</li> <li>• seismic cone</li> <li>• Becker penetration test</li> <li>• vane shear test</li> <li>• piezometers</li> <li>• geophysical testing (shear wave velocity)</li> </ul>	<ul style="list-style-type: none"> <li>• soil shear tests</li> <li>• triaxial tests (including cyclic)</li> <li>• grain size distribution</li> <li>• Atterberg Limits</li> <li>• specific gravity</li> <li>• organic content</li> <li>• moisture content</li> <li>• unit weight</li> </ul>

Geotechnical Issues	Engineering Evaluations	Required Information For Analyses	Field Testing	Laboratory Testing
		<ul style="list-style-type: none"> <li>• penetration resistance</li> <li>• shear wave velocity</li> <li>• seismicity (PGA, design earthquakes)</li> <li>• site topography</li> </ul>		
Geotechnical Issues	Engineering Evaluations	Required Information For Analyses	Field Testing	Laboratory Testing
Input for Structural Design	<ul style="list-style-type: none"> <li>• shallow foundation springs</li> <li>• p-y data for deep foundations</li> <li>• down-drag on deep foundations</li> <li>• residual strength</li> <li>• lateral earth pressures</li> <li>• lateral spreading/slope movement loading</li> <li>• post-earthquake settlement</li> </ul>	<ul style="list-style-type: none"> <li>• subsurface profile (soil, groundwater, rock)</li> <li>• shear strength (peak and residual)</li> <li>• seismic horizontal earth pressure coefficients</li> <li>• shear modulus for low strains or shear wave velocity</li> <li>• relationship of shear modulus with increasing shear strain</li> <li>• unit weight</li> <li>• Poisson’s ratio</li> <li>• seismicity (PGA, design earthquake)</li> <li>• site topography</li> </ul>	<ul style="list-style-type: none"> <li>• CPT</li> <li>• SPT</li> <li>• seismic cone</li> <li>• piezometers</li> <li>• geophysical testing (shear wave velocity)</li> <li>• vane shear test</li> </ul>	<ul style="list-style-type: none"> <li>• triaxial tests</li> <li>• soil shear tests</li> <li>• unconfined compression</li> <li>• grain size distribution</li> <li>• Atterberg Limits</li> <li>• specific gravity</li> <li>• moisture content</li> <li>• unit weight</li> <li>• resonant column</li> <li>• cyclic direct simple shear test</li> <li>• torsional simple shear test</li> </ul>

For analysis and design of standard bridges, in-situ or laboratory testing for parameters such as the dynamic shear modulus at small strains, equivalent viscous damping, shear modulus and damping ratio versus shear strain, and residual shear strength are generally not directly obtained. Instead, index properties and correlations based on in-situ field measurements (such

as the SPT and CPT) are generally used in lieu of in-situ or laboratory measurements for routine design to estimate these values. However, if a site specific ground motion response analysis is conducted, field measurements of the shear wave velocity  $V_s$  should be obtained.

If correlations are used to obtain seismic soil design properties, the following correlations are recommended. Other acceptable correlations can be found in Wair et al. (2012), Dickenson et al. (2002), Kramer (1996), Mayne (2007) and other technical references. Region and site-specific correlations developed by practitioners are acceptable with adequate supporting documentation and approval by ODOT. The use of multiple, applicable correlations, followed by weighted averaging of the computed soil parameter, is recommended. [Figures 13-2](#), [13-3](#) and [13-4](#) are provided as examples for shear modulus reduction and damping curves for soil types typically encountered. The formulations presented by Darendeli (2001) are also acceptable for use in developing shear modulus reduction and damping curves. Other alternative correlations may be necessary for unusual soils conditions such as organic soils (peats), diatomaceous soils, sawdust or highly weathered rock.

- [Table 13-5](#), presents correlations for estimating initial shear modulus ( $G_{max}$ ) based on relative density, penetration resistance, void ratio, OCR or cone resistance.
- [Figure 13-2](#), presents shear modulus reduction curves and equivalent viscous damping ratio for cohesionless soils (sands) as a function of shear strain and depth.
- [Figure 13-3](#) and [Figure 13-4](#), present shear modulus reduction curves and equivalent viscous damping ratio, respectively, as a function of cyclic shear strain and plasticity index for fine grained (cohesive) soils.
- [Figure 13-5](#), [Figure 13-6](#), [Figure 13-7](#) and [Figure 13-8](#) presents charts for estimating undrained residual shear strength for liquefied soils as a function of SPT blow counts ( $N'_{60}$ ), CPT ( $q_{cl}$ ) and vertical effective stress.

Table 13-5 Correlations for Estimating Initial Shear Modulus (SCDOT, 2010).

Reference	Correlation Equation	Units	Comments																
Seed, et al. (1984)	$G_{\max} = 220(K_2)_{\max} (\sigma'_m)^{0.5}$ $(K_2)_{\max} \approx 20(N_1)_{60}^{1/3}$	kPa	$(K_2)_{\max} \approx 30$ for loose sands and 75 for very dense sands; $\approx 80-180$ for dense well graded gravels; Limited to cohesionless soils																
Imai and Tonouchi (1982)	$G_{\max} = 15,560(N_{60})^{0.68}$	kPa	Limited to cohesionless soils																
Hardin (1978)	$G_{\max} = \frac{625}{(0.3 + 0.7e_o^2)} (P_a \sigma'_m)^{0.5} OCR^k$	kPa <sup>(1)</sup>	Limited to cohesive soils $P_a$ = atmospheric pressure $P_a$ and $\sigma'_m$ in kPa																
Jamiolkowski, et al. (1991)	$G_{\max} = \frac{625}{e_o^{1.3}} (P_a \sigma'_m)^{0.5} OCR^k$	kPa <sup>(1)</sup>	Limited to cohesive soils $P_a$ and $\sigma'_m$ in kPa																
Mayne and Rix (1993)	$G_{\max} = 99.5(P_a)^{0.305} \frac{(q_c)^{0.695}}{(e_o)^{1.13}}$	kPa	Limited to cohesive soils $P_a$ and $q_c$ in kPa																
<sup>(1)</sup> The parameter k is related to the plasticity index, PI, as follows: <table border="1" style="margin-left: 20px;"> <thead> <tr> <th>PI</th> <th>k</th> <th>PI</th> <th>k</th> </tr> </thead> <tbody> <tr> <td>0</td> <td>0.00</td> <td>60</td> <td>0.41</td> </tr> <tr> <td>20</td> <td>0.18</td> <td>80</td> <td>0.48</td> </tr> <tr> <td>40</td> <td>0.30</td> <td>&gt;100</td> <td>0.50</td> </tr> </tbody> </table>				PI	k	PI	k	0	0.00	60	0.41	20	0.18	80	0.48	40	0.30	>100	0.50
PI	k	PI	k																
0	0.00	60	0.41																
20	0.18	80	0.48																
40	0.30	>100	0.50																

Figure 13-2 -Shear modulus reduction and damping ratio curves for sand (EPRI, 1993).

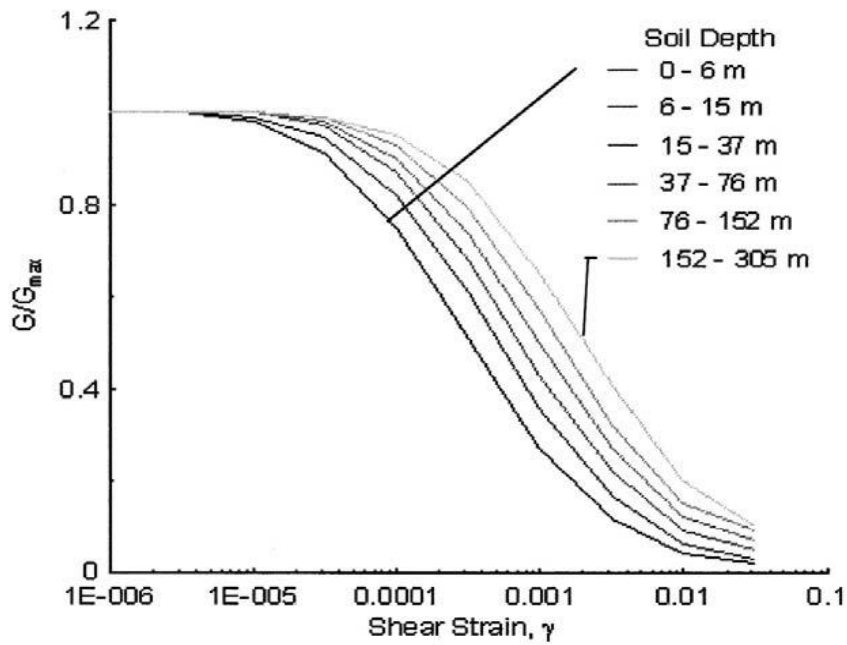

Shear Modulus Reduction Curves

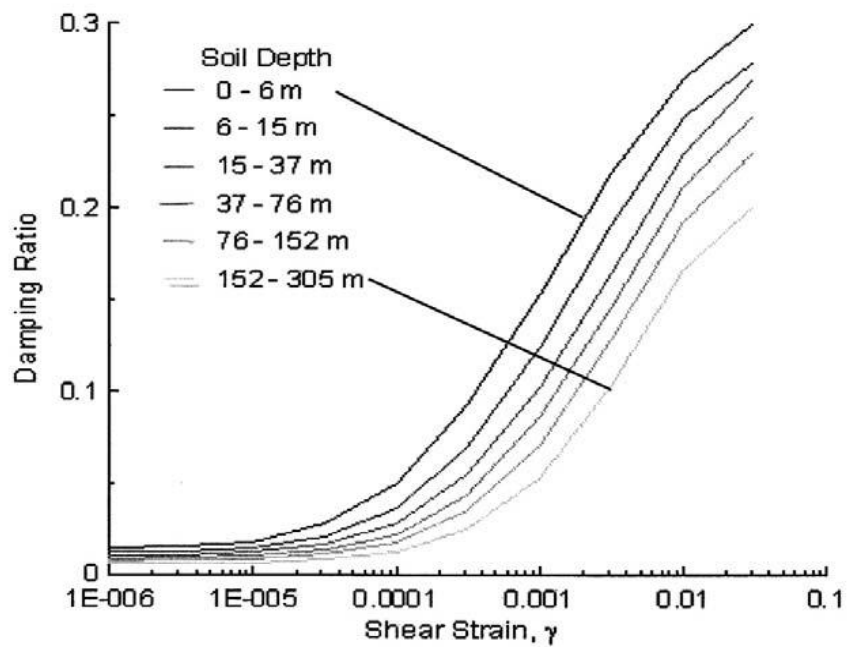

Damping Ratio Curves

Figure 13-3 Variation of  $G/G_{max}$  vs. cyclic shear strain for fine grained soils (redrafted from Vucetic and Dobry, 1991).

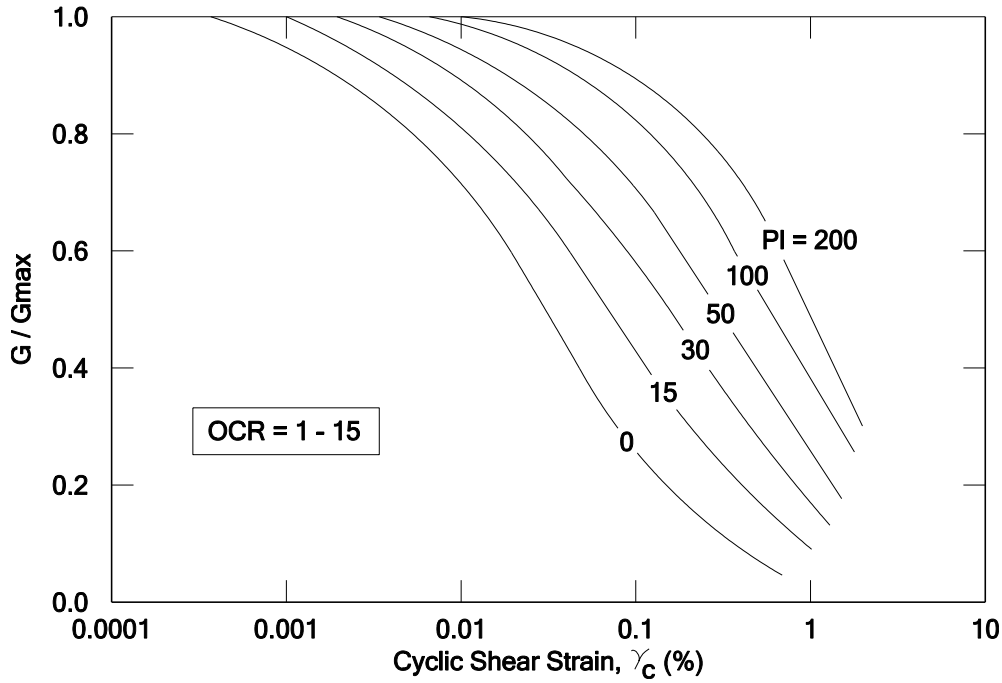

Figure 13-4 Equivalent viscous damping ratio vs. cyclic shear strain for fine grained soils (redrafted from Vucetic and Dobry, 1991).

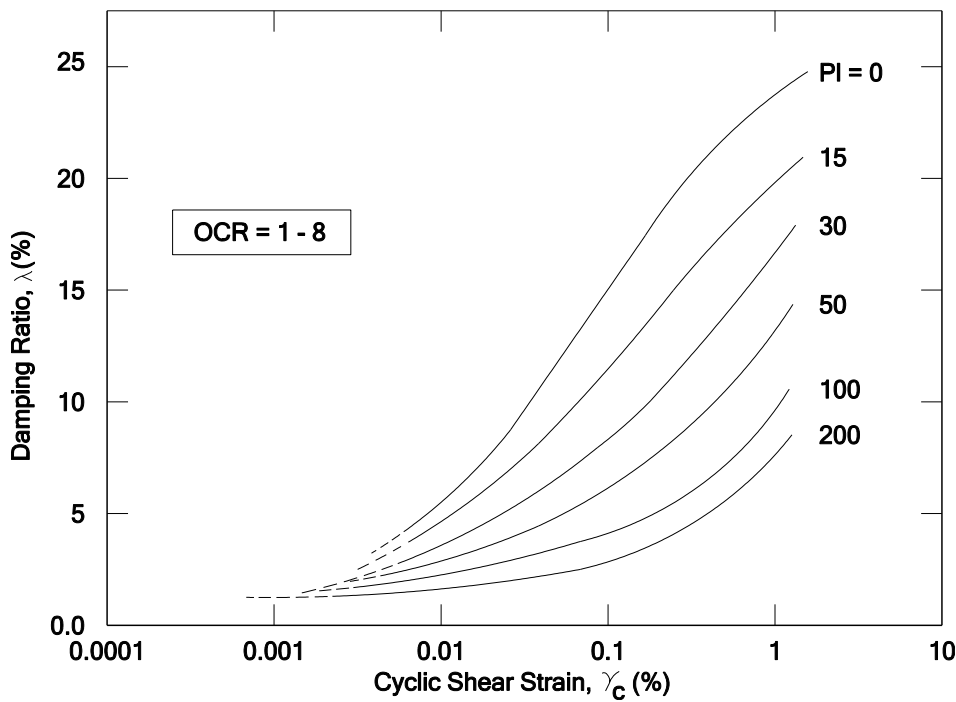

Figure 13-5 Correlation between the Residual Undrained Strength Ratio,  $S_r/\sigma'_{vo}$  and equivalent clean sand SPT blow count,  $(N_1)_{60CS}$  (Idriss and Boulanger, 2007).

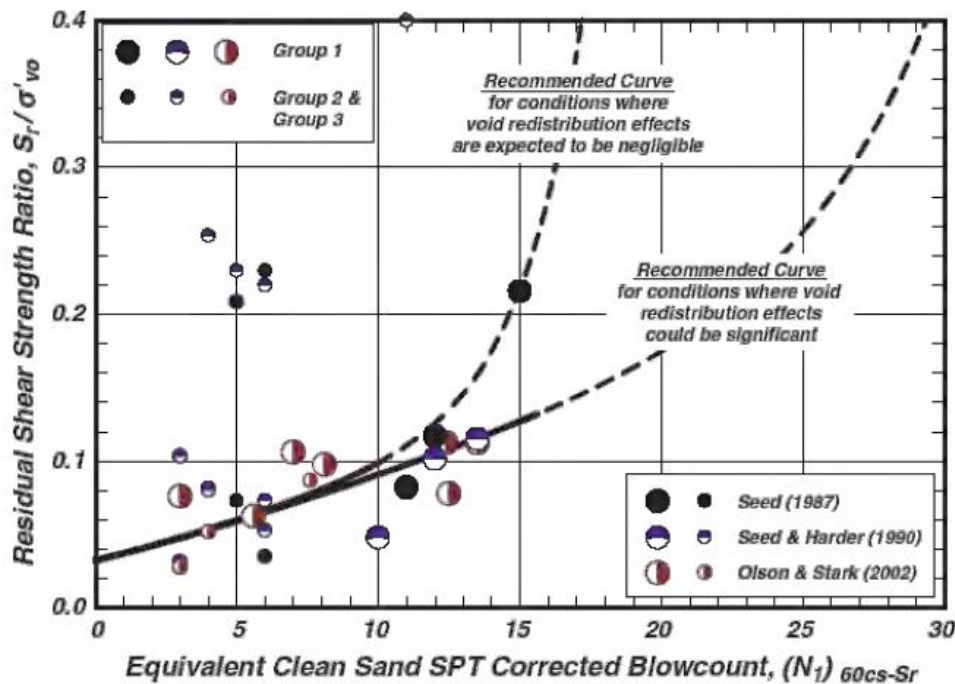

Figure 13-6 Correlation between Undrained Residual Strength Ratio ( $S_r/\sigma'_{vo}$ ) and Normalized SPT Resistance  $(N_1)_{60}$  (Olson and Johnson, 2008).

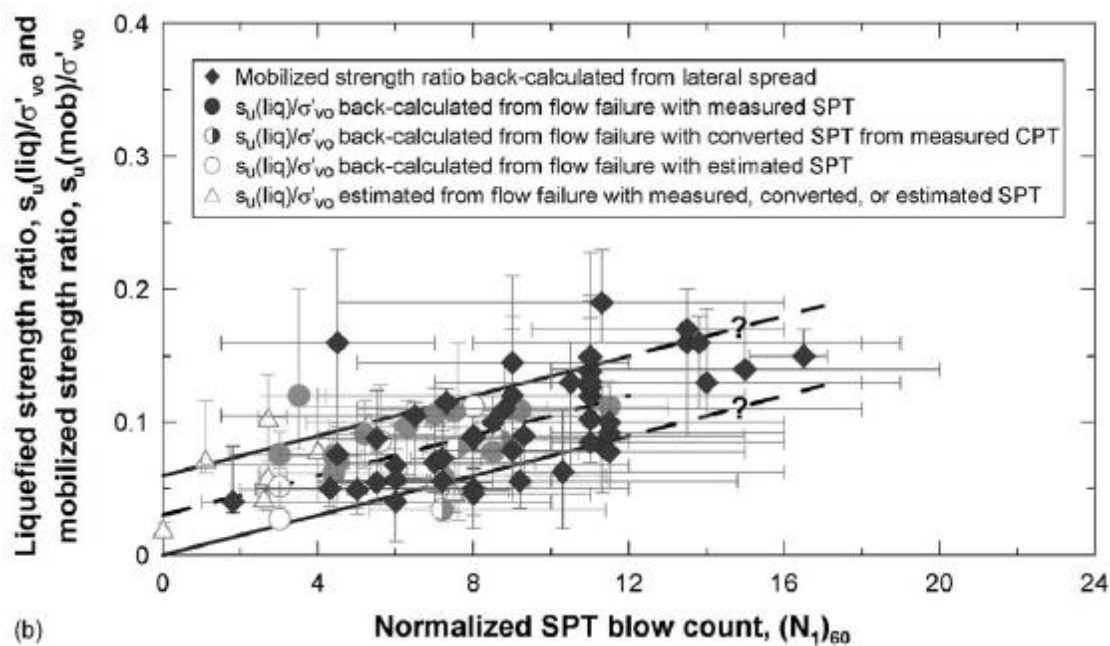

Figure 13-7 Variation of residual strength ratio with SPT resistance and initial vertical effective stress using Kramer-Wang model (Kramer, 2008).

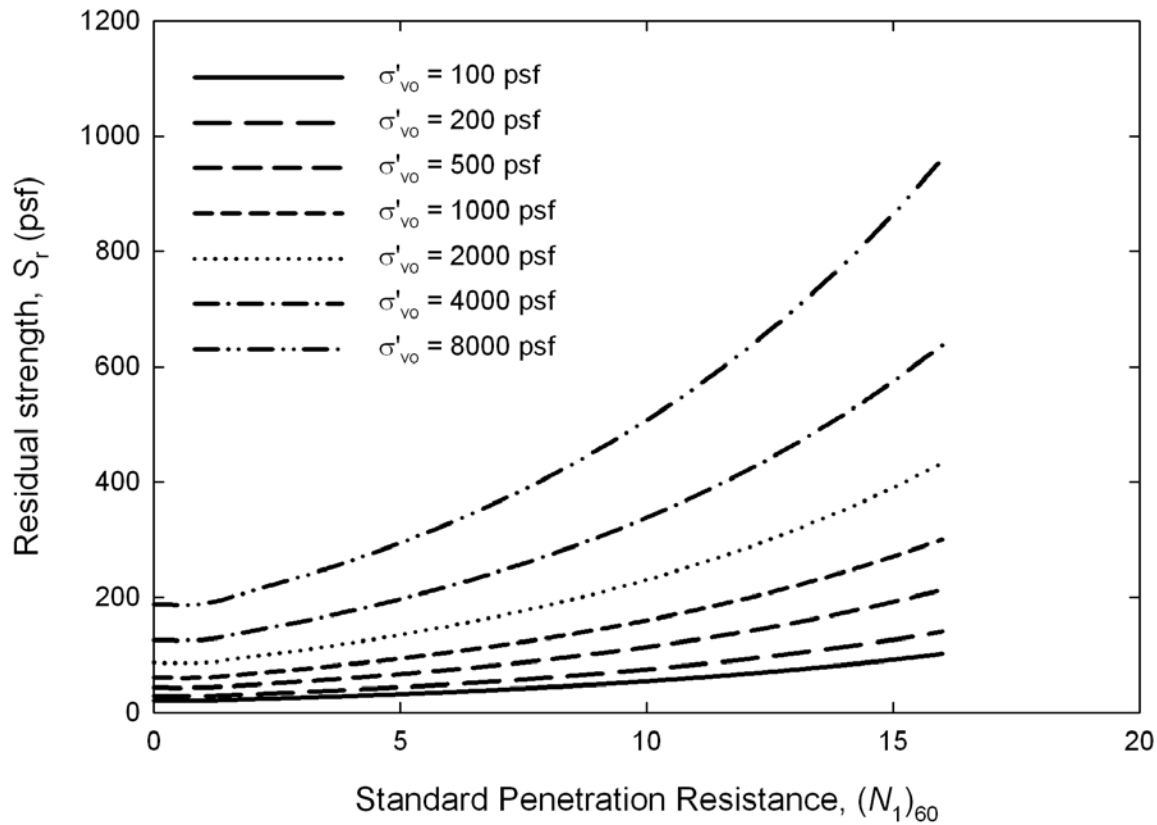
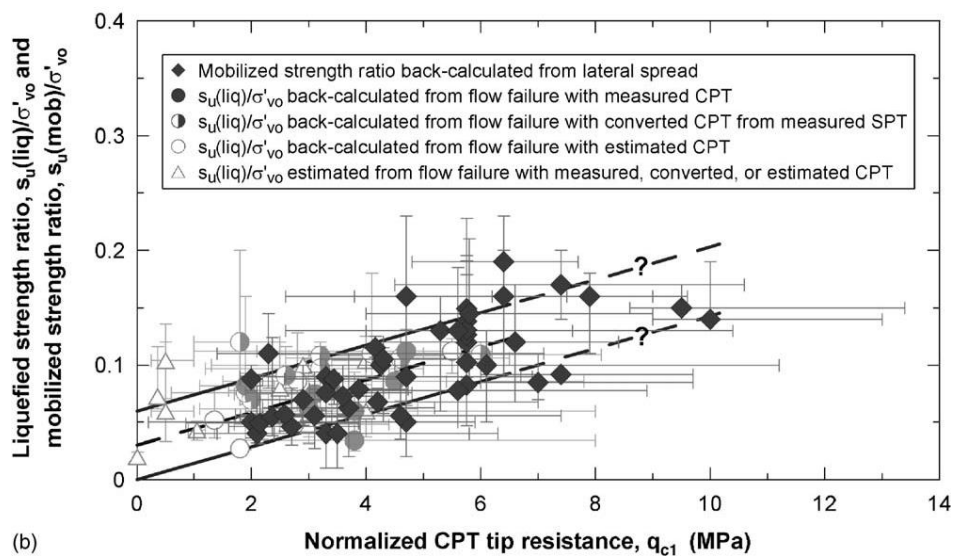

Figure 13-8 Correlation between the Undrained Residual Strength Ratio,  $S_r/\sigma'_{vo}$ , and normalized CPT tip resistance,  $q_{c1}$  (Olson and Johnson, 2008)





## 13.5 Geotechnical Seismic Design Procedures

The geotechnical designer shall evaluate the site and subsurface conditions to the extent necessary to provide the following assessments and recommendations:

- An assessment of the seismic hazard,
- Determination of design ground motion values,
- Site characterization, seismic analysis of the foundation materials, and an assessment of the effects of the foundation response on the proposed structure. Specific aspects of seismic foundation design generally consist of the following procedures:
  - Determine the Peak Bedrock Acceleration (PGA), 0.2 and 1.0 second spectral accelerations for the bridge site from the 2014 USGS National Seismic Hazard Maps for the 1000-year return period and the 2014-CSZE Seismic Hazard map,
  - Determine the Site Class and Site Coefficients based on the properties of the soil profile,
  - Develop the Design Response Spectrum for the site per AASHTO (2014) or conduct ground response analysis if necessary,
  - Determine the potential for loss of soil strength and degradation of stiffness of foundation soils,
  - If significant cyclic degradation due to excess pore pressure generation (e.g., liquefaction of sand or silt, sensitive fine-grained soil) is predicted:
    - Estimate embankment deformations due to slope instability and lateral spreading and evaluate the impacts of embankment deformations in terms of bridge damage potential and approach fill performance for both the 1000-year event and the CSZE (if appropriate),
    - Estimate embankment settlement due to seismic loading and the potential for any resulting downdrag loading and potential bridge damage,
    - Determine soil properties for both the liquefied and non-liquefied soil conditions for use in the lateral load analysis and modeling of deep foundations,
    - Determine reduced foundation resistances and their effects on proposed bridge foundation elements.
- Evaluate seismic-induced slope stability and settlement for non-liquefied soil conditions,
- Evaluate impacts of seismic-induced loads and deformations on bridge foundations,
- Develop values for nonlinear soil stiffness (e.g., foundation springs) for use in modeling dynamic loading (liquefied and non-liquefied soil conditions). Also provide recommendations regarding lateral springs for use in modeling abutment backfill soil resistance,
- Determine earthquake induced earth pressures (active and passive) and provide stiffness values for equivalent soil springs (if required) for retaining structures and below grade walls,
- Evaluate options to mitigate seismic geologic hazards, such as ground improvement, if appropriate.

Note that separate analysis and recommendations will be required for the 2014-CSZE and 1000-year seismic design ground motions. A general design procedure is described in the flow chart shown in [Figure 13-9](#) along with the information that should be supplied in the final geotechnical report.

**Figure 13-9 General Geotechnical Seismic Design Procedures**

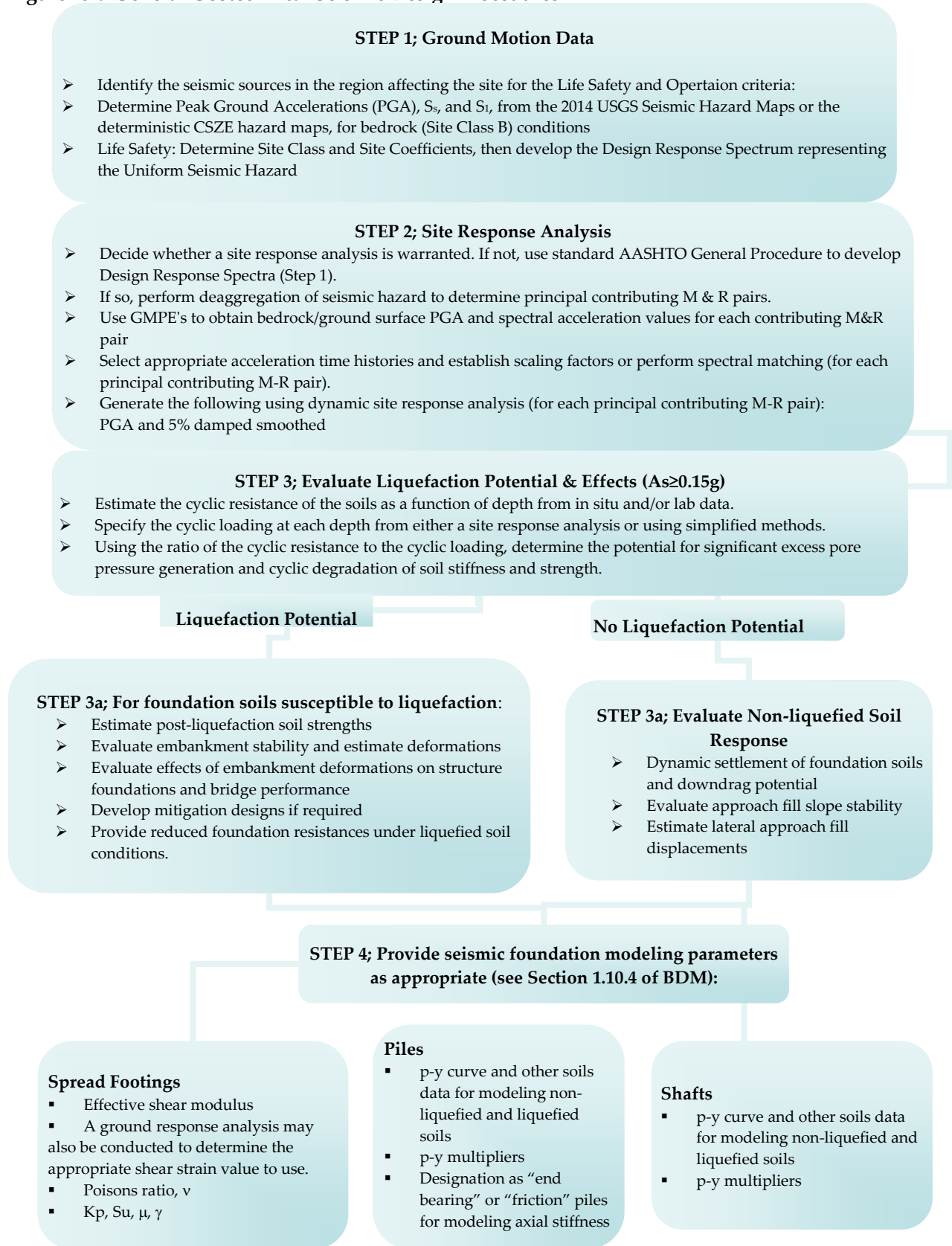

## 13.5.1 Design Ground Motion Data

### 13.5.1.1 Development of Design Ground Motion Data

The geotechnical engineer is responsible for developing and providing the design response spectra for the project.

With the implementation of the CSZE scenario, the design response spectrum generated by the [CSZE ARS](#) will be used to meet the Operational Design Criteria. If a site specific ground motion response analysis is required, the [CSZE ARS](#) at  $V_{s30}=760$ -m/s response spectrum will be used as the target spectrum which the earthquake records should be scaled.

For Life Safety, there are two options for the development of design ground motion parameters (response spectral ordinates) for seismic design. These are described as follows:

**AASHTO General Procedure:** Use ground motion values for the 2014 USGS Seismic Hazard Maps, as appropriate, combined with site coefficients in Tables 7.2-A, 7.2-B, and 7.2-C of this manual.

**Site Specific Ground Motion Response:** Use ground motion values for the 2014 USGS Seismic Hazard Maps, as appropriate, with site specific ground response analysis.

Both methods take local site effects into account. For most routine structures at sites with competent soils (i.e., no liquefiable, sensitive, or weak soils), the first method (General Procedure), described in Article 3.4 of the “*AASHTO Guide Specification for LRFD Seismic Bridge Design*”, is sufficient to account for site effects. However, the importance of the structure, the ground motion levels and the soil and geological conditions of a site may dictate the need for a Site Specific Ground Response Analysis.

At some bridge sites, the subsurface conditions (soil profile) may change dramatically along the length of the bridge and more than one response spectrum may be required to represent segments of the bridge with different soil profiles. If the site conditions dictate the need for more than one response spectrum for the bridge, the design response spectrum may be developed by combining the individual spectra into a composite spectrum that envelope the spectral acceleration values of the individual spectra.

### 13.5.1.2 AASHTO General Procedure

The standard method of developing the acceleration response spectrum is described in AASHTO, 2014. First, the peak ground acceleration (PGA), the short-period spectral acceleration ( $S_s$ ) and the long-period spectral acceleration ( $S_1$ ) are obtained for both the 1000-year return period (Life Safety evaluation). Then the soil profile is classified as one of six different site classes (A through F) based on the time-averaged shear wave velocity in the upper 30 meters of soil ( $V_{s30}$ ). This Site Class designation is then used to determine the “Site Coefficients”,  $F_{pga}$ ,  $F_a$  and  $F_v$ , except for sites classified as Site Class F, which required a site-specific ground response analysis. These site coefficients are then multiplied by the peak ground acceleration ( $F_{pga} \times \text{PGA}$ ), the short-period spectral acceleration ( $F_a \times S_s$ ) and the long

period spectral acceleration ( $Fv \times S_1$ ) respectively and the resulting values are used to develop the site response spectrum. A program, [ODOT\\_ARS\\_v2014.16](#), to develop the response spectra using the general procedure has been developed by the ODOT Bridge Section and can be accessed through the ODOT Bridge Section seismic web page.

In addition to the Site Class F soils, the standard Site Class designations may not be appropriate for other subsurface conditions. Sites with significant contrasts in the shear wave velocity among layers within 200 ft of the ground surface (i.e. strong impedance contrasts) do not conform to the model used to develop the AASHTO site coefficients. A site specific ground response analysis should be conducted to develop the design response spectrum in these cases.

Also, sites with deep soil columns, e.g. soil columns in excess of 500 ft, should also be considered candidates for a site-specific seismic response analysis, as the differences in the soil profile at these types of sites, compared to the profiles used to develop the AASHTO site coefficients, may create significant differences in site response compared to that predicted using the AASHTO site factors.

Sites with shallow bedrock conditions (less than 100 feet to bedrock) require special consideration. The AASHTO site coefficients were developed by modeling soil profiles representing each of the Site Classes that were at least 100 feet (30 meters) in depth. Where bedrock (defined as a material unit with a shear wave velocity  $\geq 2500$  fps) is less than 100 feet deep the standard methods described in AASHTO for characterizing site class are not applicable and currently there is no consensus about how to adjust site class parameters for shallow bedrock conditions. Shear wave velocities, or SPT "N", values, obtained in bedrock that is within 100 feet of the ground surface should not be included in the calculation for determining the average shear wave velocity ( $V_{s(30)}$ ) used in site class designation. In these conditions the following guidance is recommended:

- If the depth to Site Class B bedrock is greater than 80 feet, then the AASHTO site coefficients are considered acceptable for use. As an approximation the  $V_{s(30)}$  value should be computed assuming that the soil extends to a depth of 100 feet (30 m) and extrapolating the profile of  $V_s$  in the soil to that depth.
- If Site Class B bedrock is within 10 feet of the ground surface, or the base of the foundation footing or pile cap, assume Site Class B conditions.
- If the depth to Site Class B bedrock is between 10 ft and 80 ft, develop the Site Class based on the average shear wave velocity obtained from only the soil layers above the bedrock. Adjust the site class obtained from this procedure upwards to a higher site class if necessary based on engineering judgment.

At these locations, a site-specific seismic ground response analysis may also be considered. However such an analysis may lead to unrealistically amplified ground motions at the predominant period of the soil deposit. This effect should be critically reviewed and evaluated in light of the influence on ground motions in the structural period range of interest for the project.

### 13.5.1.3 Response Spectra and Analysis for Liquefied Soil Sites

Site coefficients have not been developed for liquefied soil conditions. For this case site-specific analysis is required to estimate ground motion characteristics. The “AASHTO Guide Specifications for LRFD Seismic Bridge Design, 2<sup>nd</sup> Edition” (2015) states that at sites where soils are predicted to liquefy the bridge shall be analyzed and designed under two configurations, the non-liquefied condition and liquefied soil condition described as follows:

- **Nonliquefied Configuration:** The structure is analyzed and designed, assuming no liquefaction occurs by using ground response spectrum and soil design parameters based on non-liquefied soil conditions,
- **Liquefied Configuration:** The structure is reanalyzed and designed under liquefied soil conditions assuming the appropriate residual resistance for lateral and axial deep foundation response analyses consistent with liquefied soil conditions (i.e., modified P-Y curves, modulus of subgrade reaction, T-Z curves, axial soil frictional resistance). The design spectrum should be the same as that used in non-liquefied configuration.

A site-specific response spectrum may be developed for the “Liquefied Configuration” based on a ground response analysis that utilizes non-linear, effective stress methods, which properly account for pore pressure buildup and stiffness degradation of the liquefiable soil layers. The decision to complete a ground response analysis where liquefaction is anticipated should be made by the geotechnical designer based on the site geology and characteristics of the bridge being designed. The design response spectrum resulting from the ground response analyses shall not be less than two-thirds of the spectrum developed using the general procedure for the non-liquefied soil condition.

### 13.5.1.4 Site Specific Ground Motion Response

For most projects, the General Procedure as described in Article 3.4.1 of the “AASHTO Guide Specifications for LRFD Seismic Bridge Design 2<sup>nd</sup> Edition” (2015) is appropriate and sufficient for determining the seismic hazard and site response spectrum. However, it may be appropriate to perform a site-specific evaluation for cases involving special aspects of seismic hazard (e.g., near fault conditions, high ground motion values, coastal sites located in relatively close proximity to the CSZ source), specific soil profiles, and essential bridges. The results of the site-specific response analysis may be used as justification for a reduction in the spectral response ordinates determined using the standard AASHTO design spectrum (General Procedure) representing the Uniform Seismic Hazard.

Site specific ground response analyses (GRA) are required for Site Class “F” soil profiles, and may be warranted for other site conditions or project requirements. Site Class “F” soils are defined as follows:

- Peat or highly organic clays, greater than 10 ft in thickness,
- Very high plasticity clays ( $H > 25$  ft with  $PI > 75$ ),
- Very thick soft/medium stiff clays ( $H > 120$  ft).

Other conditions under which a ground response analysis should be considered are listed below:

- Very important or critical structures or facilities,
- Liquefiable Soil Conditions. For liquefiable soil sites, it may be desirable to develop response spectra that take into account increases in pore water pressure and soil softening. This analysis results in a response spectra that is generally lower than the nonliquefied response spectra in the short-period range (approximately  $< 1.0$  sec). A nonlinear effective stress analysis may also be necessary to refine the standard liquefaction analysis based on the simplified empirical method (Youd et. al., 2001) with information from a GRA. This is especially true if liquefaction mitigation designs are proposed. The cost of liquefaction mitigation is sometimes very large and a more detailed analysis to verify the potential, and extent, of liquefaction is usually warranted,
- Very deep soil deposits, thin soil layers ( $< 50'$ ) over bedrock and profiles with high Impedance contrasts (i.e. large, abrupt changes in  $V_s$ ),
- To obtain better information for evaluating lateral deformations, near surface soil shear strain levels or deep foundation performance,
- To obtain ground surface PGA values for abutment wall or other design.

Procedures for conducting a site specific ground response analysis are described in Article 3.4.3. of AASHTO (2015) and in Chapter 5 of Kavazanjian, et al. (2011).

A ground response analysis simulates the response of a layered soil deposit subjected to earthquake motions. One-dimensional, equivalent-linear models are commonly utilized in practice. This model uses an iterative total stress approach to estimate the nonlinear elastic behavior of soils. Modified versions of the numerical model SHAKE (e.g., ProSHAKE, SHAKE91, SHAKE2000) and other models (e.g., DMOD, DEEPSOIL) are routinely used to simulate the propagation of seismic waves through the soil column and generate output consisting of ground motion time histories at selected locations in the soil profile, plots of ground motion parameters with depth (e.g., PGA, cyclic shear stress, cyclic shear strain), and acceleration response spectra at depths of interest. The program calculates the induced cyclic shear stresses in individual soil layers which may be used in liquefaction analysis.

The equivalent linear model provides reasonable results for small to moderate cyclic shear strains (less than about 1 to 2 percent) and modest accelerations (less than about 0.3 to 0.4g) (Kramer and Paulsen, 2004). Equivalent linear analysis cannot be used where large strain incompatibilities are present, to estimate permanent displacements, or to model development of pore water pressures in a coupled manner. Computer programs capable of modeling non-linear, effective stress soil behavior are recommended for sites where high ground motion levels are indicated and it is anticipated that moderate to large shear strains will be mobilized. These

are typically sites with soft to medium stiff fine-grained soils or saturated deposits of loose to medium dense cohesionless soils.

Input parameters required for site specific ground response analysis include soil layering (thickness), standard geotechnical index properties for the soils, dynamic soil properties for each soil layer, the depth to bedrock or firm soil interface, and a set of ground motion time histories representative of the primary seismic hazards in the region. Dynamic soil parameters for the equivalent linear models include the shear wave velocity, or initial (small strain) shear modulus, the unit weight for each soil layer and curves relating the shear modulus and damping ratio as a function of shear strain (see [Section 13.4.1](#) and [Figure 13-2](#), [Figure 13-3](#), [Figure 13-4](#) for examples).

Nonlinear effective stress analysis methods such as D-MOD2000, DESRA and others may also be used to develop response spectra, especially at sites where liquefaction of foundation soils is likely (see [Section 13.5.2.2](#)). All non-linear, effective stress modeling and analysis will require an independent peer reviewer with expertise in this type of analysis.

The results of the dynamic ground response modeling should be presented in the form of a standard response spectrum graph showing the "average" soil response spectrum from all of the output response spectra. Site-specific response spectra may be used for design; however the spectral ordinates shall be no less than 2/3rd of the spectral ordinates for the AASHTO response spectrum using the General Procedure. The standard AASHTO response spectrum and the "2/3 AASHTO" response spectrum should both be plotted on the same graph as the response spectrum from the site response analysis for comparison purposes. A "smoothed" response spectra may be obtained following procedures outlined in AASHTO.

Engineering judgment will be required to account for possible limitations of the response modeling. For example, equivalent linear analysis methods may overemphasize spectral response where the predominant period of the soil profile closely matches the predominant period of the bedrock motion. Final modification of the design spectrum must provide representative constant velocity and constant displacement portions of the response.

### **13.5.1.5 Selection of Time Histories for Ground Response Analysis**

AASHTO (2014) allows two options for the selection of time histories to use in ground response analysis. The two options are:

- a) Use a suite of 3 response spectrum-compatible time histories representing the bedrock motions and then define the design response spectrum at the ground surface by enveloping the maximum computed response, or
- b) Use at least 7 bedrock time histories and develop the design spectrum as the mean of the computed ground surface response spectra.



For both options, the time histories shall be developed from the representative recorded earthquake motions, or in special instances synthetic ground motions may be used with approval of ODOT. The time histories for these applications shall have characteristics that are representative of the seismic environment of the site and the local site conditions, including the response spectrum for the site.

Analytical techniques used for spectral matching shall be demonstrated to be capable of achieving seismologically realistic time series. The time histories should be spectrally-matched to the bedrock spectrum of interest. Alternatively, if ground motion scaling is used to modify the bedrock motions the bedrock spectra should match the bedrock spectrum in the period range of significance (i.e.,  $0.5 < T < 2.0$ , where “T” is the fundamental period of the structure). The predominant period of the soil profile should also be considered in the scaling process.

The procedures for selecting and adjusting time histories for use in ground motion response analysis can be summarized as follows:

1. Identify the target response spectra to be used to develop the time histories. The target spectra are obtained from the 2014 USGS Seismic Hazard Maps (for the Site Class B/C boundary) or the CSZE response spectra at  $V_{s30}=760$ -m/s, as appropriate. Two spectra may be required, one for the Operational performance level (the CSZ earthquake) and one for the Life Safety performance level (PSHA, 1000-yr event), depending on location within the state.
2. Identify the seismic sources that contribute to the seismic hazard for the site. For the Cascadia Subduction Zone event, selected subduction zone time histories that best represent and model the significant characteristics of the CSZ. For the PSHA sources use the deaggregation information for the 2014 USGS Seismic Hazard maps to obtain information on the primary sources that affect the site. Select time histories to be considered for the analysis, considering tectonic environment and style of faulting (subduction zone, Benioff zone, or shallow crustal faults), seismic source-to-site-distance, earthquake magnitude, duration of strong shaking, peak acceleration, site subsurface characteristics, predominant period, etc. In areas where the hazard has a significant contribution from both the Cascadia Subduction Zone (CSZ) and from crustal sources (e.g., Portland and much of the Western part of the state) both earthquake sources need to be included in the analysis and development of a site specific response spectra. In cases such as this, it is recommended that the ground response analysis be conducted using a collection of time histories that include at least 3 motions representative of subduction zone events and 3 motions appropriate for shallow crustal earthquakes with the design response spectrum developed considering the mean spectrum of each of these primary sources.

The adjusted time histories (either scaled or spectrally matched) must satisfy the following requirements:

1. Peak amplitudes are representative (PGA, PGV, PGD),
2. Frequency content is representative (spectral components; SA, SV, SD),

3. Duration is appropriate,
4. Energy is appropriate (e.g., Arias Intensity).

All 4 of these ground motion characteristics can be checked against up-to-date empirical relationships.

At sites where the uniform hazard is dominated by a single source, three (3) time histories, representing the seismic source characteristics, may be used and the design response spectrum determined by enveloping the caps of the resulting response spectra.

3. Scale the time histories to match the target spectrum as closely as possible in the period range of interest prior to spectral matching. Match the response spectra from the recorded earthquake time histories to the target spectra using methods that utilize either time series adjustments in the time domain or adjustments made in the frequency domain. See AASHTO (2011), Matasovic et. al., (2012) and Kramer (1996) for additional guidance on these techniques.
4. Once the time history(ies) have been spectrally matched, they can be used directly as input into the ground response analysis programs to develop response spectra and other seismic design parameters. Five percent (5%) damping is typically used in all site response analysis.

### **13.5.1.6 Near-Fault Effects on Ground Motions**

For sites located within 6 miles of a known active fault capable of producing at least a magnitude 5 earthquake the near-field effects of the fault should be considered. If the fault is included in the USGS Seismic Hazard maps, then the higher ground motions due solely to the proximity of the fault are already accounted for in the spectral acceleration values. However, the near-fault ground motion effects of directivity and directionality were not explicitly modeled in the development of national ground motion maps, and the code/specification based hazard level may be significantly unconservative in this regard. These “near-fault” effects are normally only considered for essential or critical structures and are usually not considered for routine seismic design. Consult with the bridge designer to determine the importance of the structure and the need to consider near-fault effects.

### **13.5.1.7 Ground Motion Parameters for Other Structures**

For buildings, restrooms, shelters, and other non-transportation structures, specification based seismic design parameters required by the Oregon Structural Specialty Code (OSSC) and the International Building Code (ICC., 2012) should be used. The seismic design requirements of the OSSC are based on a risk level of 2 percent probability of exceedence in 50 years. The 2 percent probability of exceedence in 50 years risk level corresponds to the maximum considered earthquake. The OSSC identifies procedures to develop a maximum considered earthquake acceleration response spectrum.

Site response shall be in accordance with the OSSC. As is true for transportation structures, for critical or unique structures or for sites characterized as soil profile Type F (thick sequence of soft soils or liquefiable soils), site response analysis may be required.

### 13.5.1.8 Site Amplification Factors

Soil amplification factors that account for the presence of soil over bedrock, with regard to the estimation of peak ground acceleration (PGA), are directly incorporated into the development of the general procedure for developing response spectra for structural design of bridges and similar structures in AASHTO (2015) and also for the structural design of buildings and non-transportation related structures in the International Building Code (IBC, 2012). Amplification factors should be applied to the peak bedrock acceleration to determine the peak ground acceleration (PGA) for liquefaction assessment, such as for use with the Simplified Method and for the estimation of seismic earth pressures and inertial forces for retaining wall and slope design. For liquefaction assessment and retaining wall and slope design, the Site Factor ( $F_{\text{pga}}$ ) presented in AASHTO (2015), Article 3.10.3.2 may be applied to the bedrock PGA used to determine the ground surface acceleration, unless a site specific evaluation of ground response is conducted. Refer to Anderson, et al. (2008) for additional guidance on the selection and use of site amplification values.

## 13.5.2 Liquefaction Analysis

Liquefaction has been one of the most significant causes of damage to bridge structures during earthquakes. Liquefaction can damage bridges, retaining walls and other transportation structures and facilities in many ways including:

- Bearing failure of shallow foundations founded above liquefied soil,
- Liquefaction induced ground settlement,
- Lateral spreading or flow failures of liquefied ground,
- Large transient displacements associated with low frequency ground motion,
- Increased active earth pressures on subsurface structures,
- Reduced passive resistance for anchors, piles, and walls,
- Floating of buoyant, buried structures, and
- Retaining wall failure.

Liquefaction refers to the significant loss of strength and stiffness resulting from the generation of excess pore water pressure in saturated, cohesionless soils. Liquefaction can occur in sand and non-plastic to low plasticity silt-rich soils, and in confined gravel layers; however, it is most common in sands and silty sands. For a detailed discussion of the effects of liquefaction, including the types of liquefaction phenomena, liquefaction-induced bridge damage, evaluation of liquefaction susceptibility, post liquefaction soil behavior, deformation analysis and liquefaction mitigation techniques refer to Kramer (2008), Caltrans (2013) and Dickenson, et al. (2002).

Liquefaction hazard assessment includes identifying soils susceptible to liquefaction on the basis of composition and cyclic resistance, evaluating whether the design earthquake loading

will initiate liquefaction or significant cyclic degradation, and estimating the potential effects on the planned facility.

Potential effects of soil liquefaction on structure foundations include the following:

- Loss of strength in the liquefied layer(s); resulting in reduced foundation stiffness and resistance to foundation loading,
- Liquefaction-induced ground settlement; resulting in downdrag loads on deep foundations,
- Slope instability due to flow failures or lateral spreading; resulting in large embankment displacements and deep foundation loads.

Due to the high cost of liquefaction mitigation measures, it is important to identify liquefiable soils and the potential need for mitigation measures early on in the design process (during the DAP (TS&L) phase) so that appropriate and adequate funding decisions are made. The following sections provide ODOT's policies regarding liquefaction and a general overview of liquefaction hazard assessment and its mitigation.

### **13.5.2.1 Liquefaction Design Policies**

All new bridges, bridge widening projects and retaining walls in areas with a ground surface seismic acceleration coefficient,  $A_s$ , greater than or equal to 0.15g should be evaluated for liquefaction potential.

The maximum considered depth of influence of liquefaction-related effects on surface structures shall be limited to 75 feet. The potential for strength and stiffness reductions due to increased seismically-induced pore pressures may be considered below this depth for specific projects (e.g., deep foundations, buried structures or utilities) based on cyclic laboratory test data and/or the use of non-linear, effective stress analysis techniques. All non-linear, effective stress modeling and analysis will require an independent peer reviewer with expertise in this type of analysis.

Bridges scheduled for Phase 2 seismic retrofits should also be evaluated for liquefaction potential if they are in a seismic zone with an acceleration coefficient,  $(A_s) \geq 0.15g$ .

In general, liquefaction is conservatively predicted to occur when the factor of safety against liquefaction ( $FS_L$ ) is less than 1.1. A factor of safety against liquefaction of 1.1 or less also indicates the potential for liquefaction-induced ground movement (lateral spread and settlement). Soil layers with  $FS_L$  between 1.1 and 1.4 will have reduced soil shear strengths due to excess pore pressure generation. For soil layers with  $FS_L$  greater than 1.4, excess pore pressure generation is considered negligible and the soil does not experience appreciable reduction in shear strength.

**Groundwater:** The groundwater level to use in the liquefaction analysis should be determined as follows:

- **Static Groundwater Condition:** Use the estimated, average annual groundwater level. Perched water tables should only be used if water is estimated to be present in these zones more than 50% of the year,
- **Tidal Areas:** Use the mean high tide elevation,
- **Adjacent Stream, Lake or Standing Water Influence:** Use the estimated, annual, average elevation for the wettest (6 month) seasonal period.

Note that groundwater levels measured in borings advanced using water or other drilling fluids may not be indicative of true static groundwater levels. Water in these borings should be allowed to stabilize over a period of time to insure measured levels reflect true static groundwater levels. Groundwater levels are preferably measured and monitored using piezometers, taking measurements throughout the climate year to establish reliable static groundwater levels taking seasonal effects into account.

### 13.5.2.2 Methods to Evaluate Liquefaction Potential

Evaluation of liquefaction potential should be based on soil characterization using in-situ testing methods such as Standard Penetration Tests (SPT) and Cone Penetration Tests (CPT). Liquefaction potential may also be evaluated using shear wave velocity ( $V_s$ ) testing and Becker Penetration Tests (BPT); however, these methods are considered supplementary unless the soil profile includes clean gravels and adjacent soil layers that may impede the rapid dissipation of excess pore water pressure during cyclic loading.  $V_s$  and BPT testing may be appropriate in soils difficult to test using SPT and CPT methods such as gravelly soils though, in the absence of fine grained soil layers that may act as poorly drained boundaries, these soils often have a low susceptibility to liquefaction potential due to high permeability and rapid drainage. If the CPT method is used, SPT sampling and soil gradation testing shall still be conducted to obtain direct information on soil type and gradation parameters for use in liquefaction susceptibility assessment.

**Preliminary Screening:** A detailed evaluation of liquefaction potential is not required if any of the following conditions are met:

- The peak ground acceleration coefficient,  $A_s$ , is less than 0.15g,
- The ground water table is more than 75 feet below the ground surface,
- The soils in the upper 75 feet of the profile are low plasticity silts, sand, or gravelly sand having a minimum SPT resistance, corrected for overburden depth and hammer energy ( $N_{160}$ ), of 25 blows/ft., a cone tip resistance  $q_{cIN}$  of 150 tsf or a minimum shear wave velocity of 800 feet/sec.
- All soils in the upper 75 feet have a  $P_1 > 12$  and a water content ( $W_c$ ) to liquid limit (LL) ratio of less than 0.85. Note that cohesive soils with  $P_1 > 12$  may still be very soft or exhibit sensitive behavior and could therefore undergo significant strength loss under earthquake shaking. This criterion should be used with care and good engineering judgment. Refer to Bray and Sancio, (2006) and Boulanger and Idriss, (2006) for additional information regarding the evaluation of fine-grained soils for strength loss during cyclic loading.

**Simplified Procedures:** Simplified Procedures should always be used to evaluate the liquefaction potential even if more rigorous methods are used to supplement or refine the analysis. The Simplified Procedure was originally developed by Seed and Idriss (1971) and has been periodically modified and improved since. It is routinely used to evaluate liquefaction resistance in geotechnical practice.

The paper titled “Liquefaction Resistance of Soils: Summary Report from the 1996 NCEER/NSF Workshops on Evaluation of Liquefaction Resistance of Soils” (Youd et al., (2001) should be referenced for the Simplified Procedures to be used in the assessment of liquefaction susceptibility. This paper resulted from a 1996 workshop of liquefaction experts sponsored by the National Center for Earthquake Engineering Research and the National Science Foundation with the objective being to gain consensus on updates and augmentation of the Simplified Procedures. Youd et al. (2001) provide procedures for evaluating liquefaction susceptibility using SPT, CPT,  $V_s$ , and BPT criteria.

The Simplified Procedures are based on the evaluation of both the cyclic resistance ratio (CRR) of a soil layer (i.e., the cyclic shear stress required to cause liquefaction) and the earthquake induced cyclic shear stress ratio (CSR). The resistance value (CRR) is estimated based on empirical charts relating the resistance available to specific index properties (i.e. SPT, CPT, BPT or shear wave velocity values) and corrected to an equivalent magnitude of 7.5 using a magnitude scaling factor. Youd et al. (2001) provide the empirical liquefaction resistance charts for both SPT and CPT data to be used with the simplified procedures. Since the publication of this consensus paper, various other modifications to the consensus approach have been introduced, including those by Cetin et al. (2004), Moss et al. (2006), Boulanger and Idriss (2006), and Idriss and Boulanger (2008). These more recent modifications to these methods account for additions to the database on liquefaction, as well as refinements in the interpretation of case history data. The updated methods potentially offer improved estimates of liquefaction potential, and should be considered for use.

The basic form of the simplified procedures used to calculate the earthquake induced CSR for the Simplified Method is shown in the following equation:

**Equation 13-1**

$$CSR_{eq} = \frac{\tau_{av}}{\sigma_{vo}'} = 0.65 \left( \frac{a_{max}}{g} \right) \left( \frac{\sigma_{vo}}{\sigma_{vo}'} \right) r_d$$

Where:  $\tau_{av}$  = average or uniform earthquake induced cyclic shear stress

$a_{max}$  = peak horizontal acceleration at the ground surface accounting for site amplification effects (ft/sec<sup>2</sup>)

$g$  = acceleration due to gravity (ft/sec<sup>2</sup>)

$\sigma_o$  = initial total vertical stress at depth being evaluated (lb/ft<sup>2</sup>)

$\sigma'_o$  = initial effective vertical stress at depth being evaluated (lb/ft<sup>2</sup>)

$r_d$  = stress reduction coefficient

The factor of safety against liquefaction is defined by:

$$FS_{liq} = CRR/CSR$$

The use of the SPT for the Simplified Procedure has been most widely used and has the advantage of providing soil samples for fines content and gradation testing. The CPT provides the most detailed soil stratigraphy, is less expensive, can simultaneously provide shear wave velocity measurements, and is more reproducible. If the CPT is used, soil samples shall be obtained using the SPT or other methods so that detailed gradational and plasticity analyses can be conducted. The use of both SPT and CPT procedures can provide the most detailed liquefaction assessment for a site.

Where SPT data is used, the sampling and testing procedures should include:

- Documentation on the hammer efficiency (energy measurements) of the system used,
- Correction factors for borehole diameter, rod length and sampler liners should be used, where appropriate,
- Where gravels or cobbles are present, the use of short interval adjusted SPT N values may be effective for estimating the N values for the portions of the sample not affected by gravels or cobbles,
- Blowcounts obtained using non-standard samplers such as the Dames and Moore or modified California samplers shall not be used for liquefaction evaluations.

Liquefaction potential may also be evaluated using shear wave velocity ( $V_s$ ) testing and Becker Penetration Tests (BPT); however, these methods are considered supplementary unless the soil profile includes clean gravels and adjacent soil layers that may impede the rapid dissipation of excess pore water pressure during cyclic loading.  $V_s$  and BPT testing may be appropriate in soils difficult to test using SPT and CPT methods such as gravelly soils though, in the absence of fine grained soil layers that may act as poorly drained boundaries, these soils often have a low susceptibility to liquefaction potential due to high permeability and rapid drainage. The Becker Penetration Test (BPT) is often used for major projects involving gravelly foundation soils. Recent investigations of the BPT have highlighted the strengths and limitations of the methods, as well as demonstrated the need for energy measurements in order to convert BPT blow counts to equivalent SPT  $N_{60}$  values (Ghafghazi et al, 2014).

If liquefaction is predicted based on the Simplified Method, and the effects of liquefaction require mitigation measures, a more thorough ground response analysis (e.g. SHAKE, DMOD) should be considered to verify and substantiate the predicted, induced ground motions. This procedure is especially recommended for sites where liquefaction potential is marginal ( $0.9 < FS_L < 1.10$ ). It is also important to determine whether the liquefied soil layer is stratigraphically (laterally) continuous and oriented in a manner that will result in lateral spread or other adverse impact to the structure or facility.

**Limitations of the Simplified Procedures:** The limitations of the Simplified Procedures should be recognized. The Simplified Procedures were developed from empirical evaluations of field observations of ground surface evidence for the occurrence or non-occurrence of liquefaction at depth. Most of the case history data was collected from level to gently sloping terrain underlain by Holocene-age alluvial or fluvial sediment at depths less than 50 feet. Therefore, the Simplified Procedures are applicable to only these site conditions. Caution should be used for evaluating liquefaction potential at depths greater than 50 feet using the Simplified Procedure. In addition, the Simplified Procedures estimate the trend of earthquake induced cyclic shear stress ratio with depth based on a coefficient,  $r_d$ , which becomes highly variable at depths below about 40 feet.

As an alternative to the Simplified Procedures, one dimensional ground response analyses should be used to better determine the maximum earthquake induced shear stresses at depths greater than about 50 feet. Equivalent linear or nonlinear, total stress computer programs (e.g. Shake2000, ProShake, DEEPSOIL, DMOD) may be used for this purpose.

**Magnitude and PGA for Liquefaction Analysis:** The procedures described in [Section 7.3.2](#) and [Section 7.3.3](#) should be used to determine the appropriate earthquake magnitude and peak ground surface acceleration to use in the simplified procedure for liquefaction analysis. If a site specific ground response analysis is used to determine the peak ground surface acceleration(s) for use in liquefaction analyses, this value should be representative of the cyclic loading induced by the M-R pair(s) of interest. It is anticipated that PGA values obtained from site-specific ground response analysis will often differ from the PGA determined by the AASHTO General Procedure for the uniform seismic hazard. The PGA and magnitude values used in the liquefaction hazard analysis shall be tabulated for all considered seismic sources.

**Magnitude Scaling Factors (MSF):** Magnitude scaling factors are required to adjust the cyclic stress ratios (either CRR or CSR) obtained from the Simplified Method (based on  $M = 7.5$ ) to other magnitude earthquakes. The range of Magnitude Scaling Factors recommended in the 1996 NCEER Workshop on Evaluation of Liquefaction Resistance of Soils (Youd, et. al., 2001) is recommended. Below magnitude 7.5, a range is provided and engineering judgment is required for selection of the MSF. Factors more in line with the lower bound range of the curve are recommended. Above magnitude 7.5 the factors recommended by Idriss are recommended. This relationship is presented in the graph ([Figure 13-10](#)) and the equation of the curve is:  $MSF = 10^{2.24 / M^{2.5}}$ .



Figure 13-10 Magnitude Scaling Factors Derived by Various Investigators (redrafted from 1996 NCEER Workshop Summary Report)

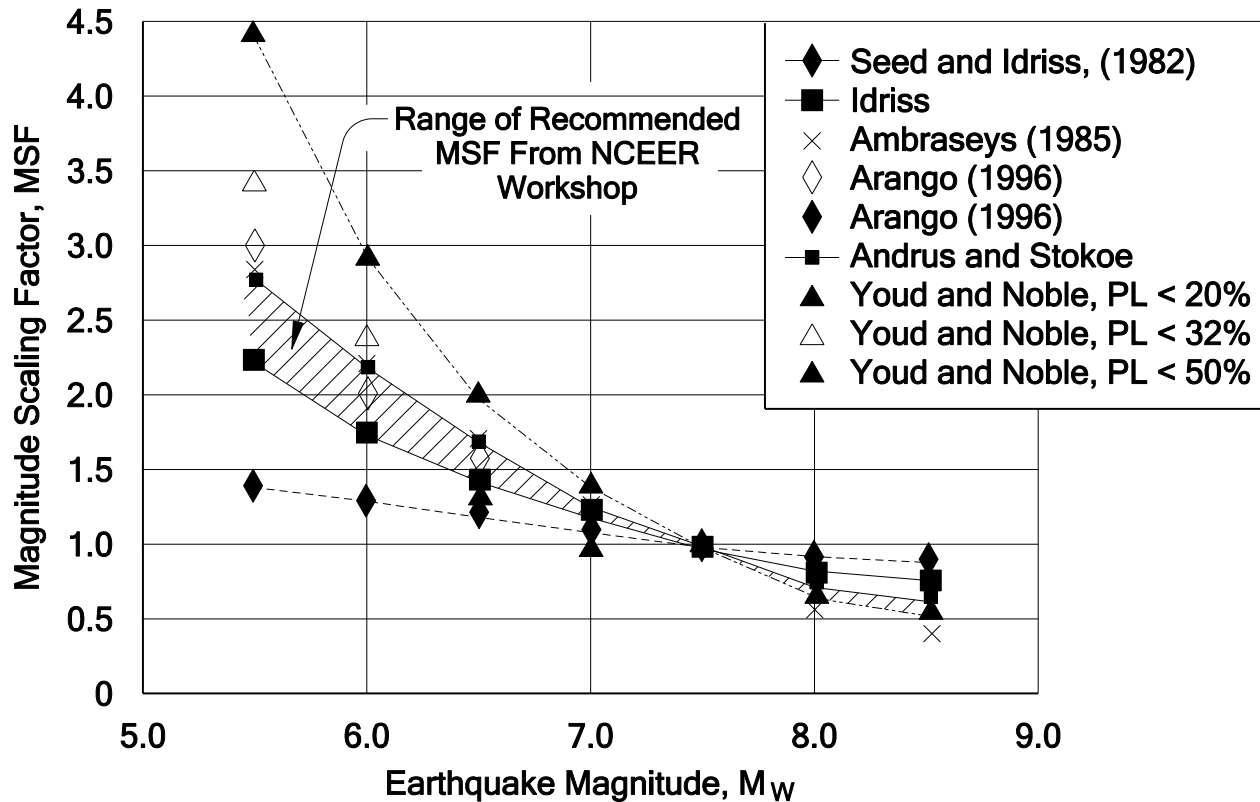

It should be noted that the topic of Magnitude Scaling Factors has been the focus of considerable investigation over the past decade. Recent refinements to the MSF's have been made that account for soil density, soil-specific cyclic resistance (i.e., the slope of the cyclic resistance curve), and confining stress (e.g., Boulanger and Idriss, 2014). It is recommended that the most current procedures for evaluating soil liquefaction be considered for use on ODOT projects; however, refinements in one generation of the liquefaction triggering procedures should not be used with earlier methods, or with methods developed by different investigators. For example, the MSF's proposed by Boulanger and Idriss (2014) should not be used with the liquefaction triggering procedure as presented by Youd et al (2001). The methods must be applied in a consistent manner following the procedures developed by the specific investigators.

**Nonlinear Effective Stress Methods:** An alternative to the simplified procedures for evaluating liquefaction susceptibility is to perform a nonlinear, effective stress site response analysis utilizing a computer code capable of modeling pore water pressure generation and dissipation (D-MOD2000, DESRA, FLAC). These are more rigorous analyses and they require additional soil parameters, validation by the practitioner, and additional specialization.

The advantages of this method of analysis include the ability to assess liquefaction at depths greater than 50 feet, the effects of liquefaction and large shear strains on the ground motion, and the effects of higher accelerations that can be more reliably evaluated. In addition, seismically induced

deformation can be estimated, and the timing of liquefaction and its effects on ground motion at and below the ground surface can be assessed.

Several non-linear, effective stress analysis programs can be used to estimate liquefaction susceptibility at depth. However, few of these programs are being used by geotechnical designers in routine practice at this time. In addition, there has been little verification of the ability of these programs to predict liquefaction at depths greater than 50 feet because there are few well documented sites of deep liquefaction. In addition, there is the potential for these programs to underestimate the liquefaction potential of near surface soils layers due to ground motion damping effects in underlying liquefied soil layers. This effect may be inherent in the program analysis and should be thoroughly evaluated.

Due to the highly specialized nature of these more sophisticated liquefaction assessment approaches, an independent peer review by an expert in this type of analysis is required to use nonlinear effective stress methods for liquefaction evaluation.

### 13.5.2.3 Liquefaction Induced Settlement

Both dry and saturated deposits of loose granular soils tend to densify and settle during earthquake shaking. Settlement of unsaturated (dry) granular deposits is discussed in [Section 7.5.4](#). If the Simplified Procedure is used to evaluate liquefaction potential, liquefaction induced ground settlement of saturated sandy soils should be estimated using the procedures by Tokimatsu and Seed (1987), Ishihara and Yoshimine (1992) or more recent methods that have been documented in the technical literature (Zhang et al. 2002, Cetin et al, 2009, Tsukamoto and Ishihara, 2010). The Tokimatsu and Seed (1987) procedure estimates the volumetric strain as a function of earthquake induced CSR and corrected SPT blowcounts. The Ishihara and Yoshimine (1992) procedure estimates the volumetric strain as a function of factor of safety against liquefaction, relative density, and corrected SPT blowcounts or normalized CPT tip resistance. Example charts used to estimate liquefaction induced settlement using the Tokimatsu and Seed procedure and the Ishihara and Yoshimine procedure are presented in [Figure 13-11](#) and [Figure 13-12](#), respectively. Refer to Kavazanjian, et. al., (2011) for additional guidance on settlement analysis of liquefiable soils.

Non-plastic to low plasticity silts ( $PI \leq 12$ ) have also been found to be susceptible to volumetric strain following liquefaction. In cases where saturated silt is liquefiable the post-cyclic loading volumetric strain should be estimated from project-specific cyclic laboratory testing, or approximated from the relationships developed by Ishihara and Yoshimine.

Figure 13-11 Post-liquefaction volumetric strain estimated using the Tokimatsu & Seed procedure (redrafted from Tokimatsu and Seed, 1987).

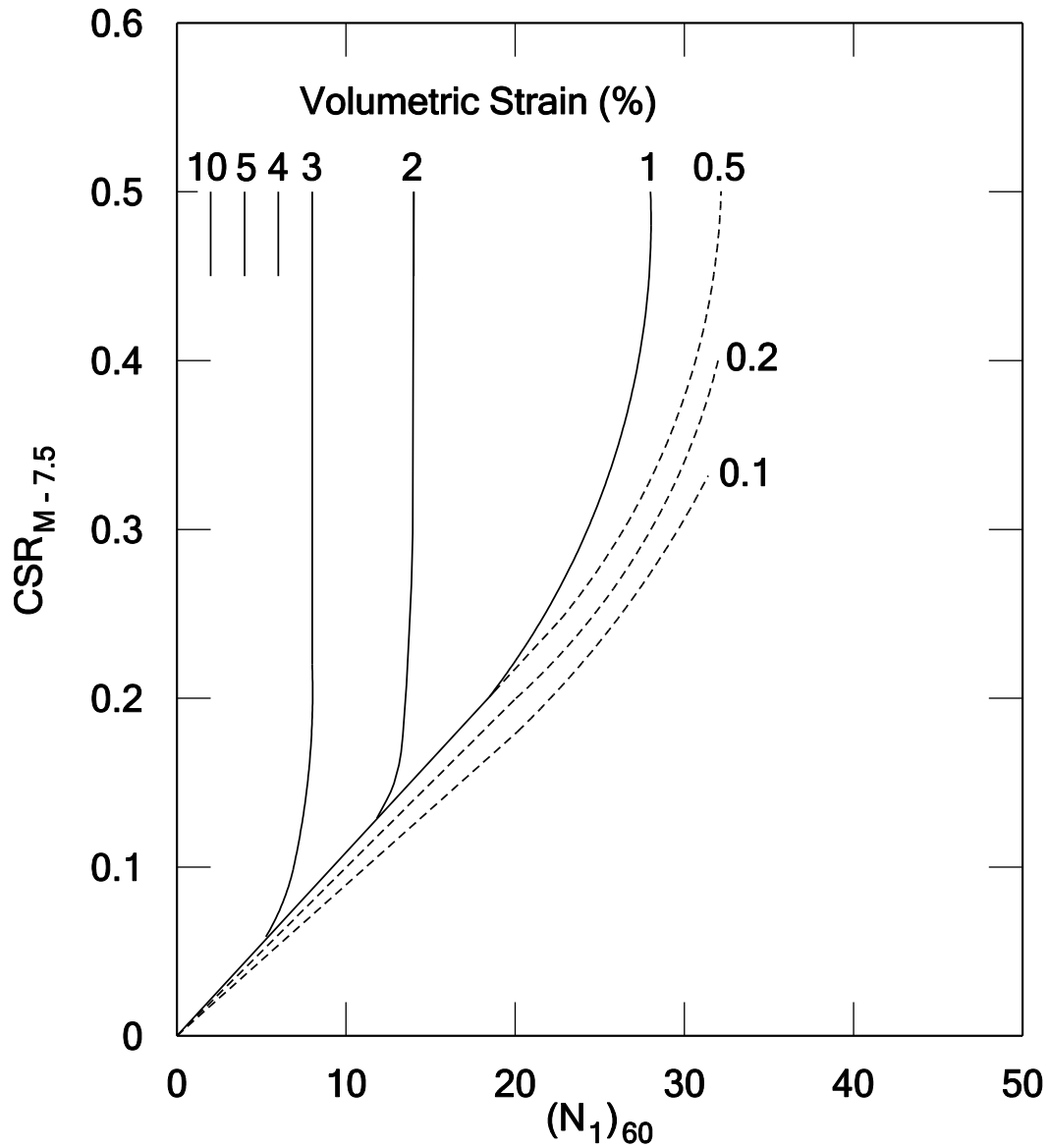
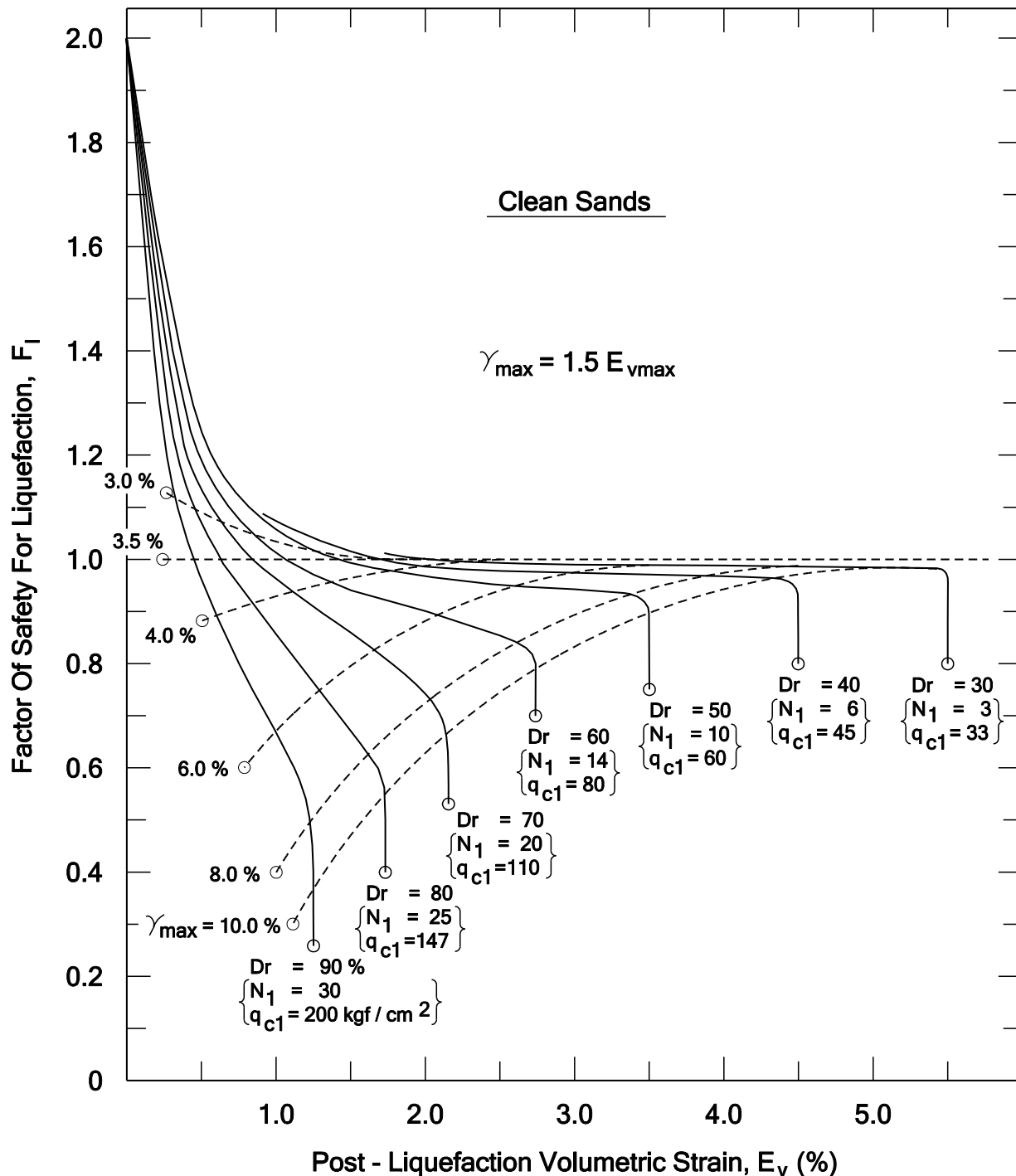

Figure 13-12 Post-liquefaction volumetric strain estimated using the Ishihara and Yoshimine procedure. (redrafted from Ishihara and Yoshimine, 1992).



### 13.5.2.4 Residual Strength Parameters

Liquefaction induced ground failure and foundation damage are strongly influenced by the residual strength of the liquefied soil. Instability occurs when the shear stresses required to

maintain equilibrium exceed the residual strength of the soil deposit. Evaluation of residual strength of a liquefied soil deposit is one of the most difficult problems in geotechnical practice. A variety of empirical methods based on back-calculated shear strengths from lateral spreads and flow failures are available to estimate the residual strength of liquefied sand. The procedures recommended in [Chapter 7](#) should be used to estimate residual strength of liquefied sand. Other methods as described in Kramer (2008) may also be used.

All of these methods estimate the residual strength of a liquefied sand deposit based on an empirical relationship between residual undrained shear strength and equivalent clean sand SPT blowcounts or CPT  $q_{cl}$  values using the results of back-calculation of the apparent shear strengths from case histories, including flow slides. All of these methods should be used to calculate the residual undrained shear strength and an average value selected based on engineering judgment, taking into consideration the basis and limitations of each correlation method.

When laboratory residual shear strength test results are obtained and used for design, the empirically based analyses should still be conducted as a baseline evaluation to qualitatively check the reasonableness of the laboratory test results. The final residual shear strength value selected from the laboratory testing should also consider the amount of shear strain in the soil that can be tolerated by the structure or slope being impacted by the reduced shear strength (i.e., how much lateral deformation can the structure tolerate?).

### 13.5.3 Slope Stability and Deformation Analysis

Earthquake-induced ground motions imposed on sloping earth structures and native slopes can result in slope instability due to: 1) strength loss in the soil caused by increases in pore water pressures (cyclic degradation and/or full liquefaction), 2) inertial effects associated with ground accelerations, or 3) combinations of both. Inertial slope instability is caused by temporary exceedance of the soil strength by the combination of static shear stresses and the transient shear stresses imposed by the earthquake. In this case the soil strength remains generally unaffected by the earthquake shaking. In other cases the earthquake shaking results in the soil becoming progressively weaker to the point where the soil shear strength becomes insufficient to maintain a stable slope.

Seismic slope instability analysis is conducted to assess the impact of instability and slope deformation on structures such as bridges, tunnels, and walls. Slopes that do not impact such structures are generally not evaluated or mitigated for seismic slope instability.

The methods described in this section, in Kavazanjian et al., (2011) and in Anderson et al., (2008) should be used to assess seismic slope stability and for estimating ground displacements. The slopes and conditions requiring such assessments and analysis are described in [Chapter 7](#).

#### 13.5.3.1 Pseudo-static Analysis

A pseudo-static seismic slope stability analysis should be conducted at each bridge site regardless of whether or not liquefied soil conditions are predicted. The pseudo-static analysis

shall consist of conventional limit equilibrium static slope stability analysis, using horizontal and vertical pseudo-static acceleration coefficients ( $k_h$  and  $k_v$ ) as described in this section.

Pseudo-static analyses do not result in predictions of slope deformation and therefore are not sufficient for evaluation of bridge approach fill performance (such as meeting serviceability criteria) or for evaluating the effects of lateral embankment displacements on bridge foundations at the extreme limit state. The pseudo-static analysis is generally used to determine:

- 1) If the slope/embankment will be stable under the design seismic loading (i.e., there's a sufficient margin of safety against failure such that permanent deformations are likely within acceptable estimated deformations), in which case no further analysis will be necessary,
- 2) A yield acceleration for use in the Newmark (or other) analysis for estimating ground displacements, as described in [Chapter 7](#), or
- 3) Whether or not a slope over liquefiable soils may fail in the form of a "flow failure" as described below.

Methods for conducting dynamic slope stability analysis under non-liquefied and liquefied conditions, and methods for determining embankment displacements under these conditions, are described in the following sections.

**Non-liquefied Soil Conditions:** If liquefaction of the foundation soils is not predicted, ground accelerations may still produce inertial forces within the slope or embankment that could exceed the strength of the foundation soils and result in slope failure and/or large displacements. At these sites a pseudo-static analysis, which includes earthquake induced inertia forces, is conducted to determine the general stability of the slope or embankment under these conditions. The pseudo-static analysis is also used to determine the yield acceleration for use in estimating slope or embankment displacements.

The soil inertia forces should be modeled using a horizontal pseudo-static coefficient,  $k_h$ , of  $0.5A_s$  and a slope height reduction factor to account for wave scattering effects as described in Kavazanjian et al. (2011) and Anderson (2008). The vertical pseudo-static coefficient,  $k_v$ , should be equal to zero. For these conditions, the minimum allowable factor of safety (C/D ratio) is 1.1. Permanent seismic slope deformations of 1 to 2 inches can be anticipated under this condition. If the factor of safety is less than 1.1 but greater than 1.0, embankment displacements should be estimated using the Newmark methods described in [Chapter 7](#) and the results evaluated in terms of meeting overall seismic performance requirements. For factors of safety equal to or less than 1.0, embankment stabilization measures should be designed and constructed to mitigate the condition and provide for a factor of safety of at least 1.1.

**Liquefiable Soil Conditions:** If soils vulnerable to cyclic degradation (liquefiable soils, sensitive soils, brittle soils) are present, slope instability may develop in the form of flow failures, lateral spreading or other large embankment deformations.

Flow failures are driven by large static stresses that lead to large deformations or flow following triggering of liquefaction. Such failures are similar to debris flows and are characterized by

sudden initiation, rapid failure, and the large distances over which the failed materials move (Kramer, 1996). Flow failures typically occur near the end of strong shaking or shortly after shaking. However, delayed flow failures caused by post-earthquake redistribution of pore water pressures can occur –particularly if liquefiable soils are capped by relatively impermeable layers. For flow failures, both stability and deformation should be assessed and mitigated if stability failure or excessive deformation is predicted.

Conventional limit equilibrium slope stability analysis methods should be used to assess flow failure potential. Residual undrained shear strength parameters are used to model the strength of the liquefied soil. Under these liquefied soil conditions, slope stability is usually modeled in the “post-earthquake” condition without including any inertial force from the earthquake ground motions (a de-coupled analysis) and the horizontal and vertical pseudo-static coefficients,  $k_h$  and  $k_v$ , should both be set equal to zero.

Where the factor of safety is less than 1.05 flow failure shall be considered likely. In these instances, the magnitude of deformation is usually too large to be acceptable for design of bridges or structures, and some form of mitigation may be appropriate. The exception is where the liquefied material and crust flow past the structure and the structure can accommodate the imposed loads (see [Chapter 7](#)). Where the factor of safety is greater than 1.05, deformation and stability shall be evaluated using the lateral spread deformation analysis methods described in [Chapter 7](#).

### 13.5.3.2 Deformation Analysis

Deformation analyses should be employed where estimates of the magnitude of seismically induced slope deformation are required. This is especially important for bridge approach fills where the deformation analysis is a crucial step in evaluating whether or not the bridge performance requirements described in [Chapter 7](#) will be met.

Lateral spreading is the horizontal displacement that occurs on mostly level ground or gentle slopes (< 5 degrees) as a result of liquefaction of shallow sandy soil deposits. The soil can slide as intact blocks down the slope towards a free face such as an incised river channel. Lateral spreading, in contrast to flow failures, occurs when the shear strength of the liquefied soil is incrementally exceeded by the inertial forces induced during an earthquake or when soil stiffness degrades sufficiently to produce substantial permanent strain in the soil. As a result of the slope instability, a failure surface resembling a sliding block typically develops along the liquefied soils and is subject to lateral displacements until equilibrium is restored. Lateral spreading at bridge approaches typically results in the horizontal displacement of the approach fill downslope or towards a free face. The resulting lateral movements can range in magnitude from inches to several feet and are typically accompanied by ground cracking with horizontal and vertical offsets. In contrast to flow failures, lateral spreading analysis is by definition a coupled analysis (i.e., directly considers the effect of seismic acceleration).

At sites where liquefaction is predicted, a lateral spreading/displacement analysis shall be conducted if the factor of safety for slope stability from a pseudo-static analysis, using post-earthquake soil strength parameters, is 1.05 or greater (no flow failure conditions). Lateral

spread analysis does not need to be conducted if the depth below the natural ground surface to the upper boundary of the liquefied soil layers is greater than 50 ft.

Several approaches have been proposed for estimating lateral spreading displacements. Four of these approaches are described below for use in the assessment of lateral spread displacements. These four approaches are: 1) Empirical-based, 2) Semi-empirical based 3) Newmark-based and 4) Numerical Modeling methods. At sites where liquefaction is not predicted, lateral deformation analysis should be conducted using any of the Newmark based methods. For evaluation and estimates of lateral spread displacement a minimum of three methods, one taken from each approach, should be used to demonstrate a likely range of potential lateral displacements. This range of lateral displacements should then be used with engineering judgment to determine lateral spread displacement values to be used in the further assessment of bridge performance (i.e. foundation loading and meeting serviceability performance requirements).

**Empirical-Based Approaches:** Empirical models for lateral spreading displacements have been developed by using regression techniques with compiled data from lateral spreading case histories.

The following methods are recommended:

- Youd et al. (2002)
- Rauch & Martin (2000)

Input into the models include earthquake magnitude, source-to-site distance, and site geometry/slope, cumulative thickness of saturated soil layers and their characteristics (e.g. SPT “N” values, average fines content and average grain size). These methods are based on regression analysis of these input parameters, and other independent variables, correlated to field measurements of lateral spread. Therefore they are best applied to site conditions that fit within the range of variables used in the models. Care should be taken when applying these methods to sites with conditions outside the range of the model variables. These procedures provide a useful approximation of the potential magnitude of deformation that is calibrated against lateral spreading deformations observed in actual earthquakes. In addition to the cited references for each method, see Kramer (2008) for details on how to carry out these methods. These methods should be used primarily as a preliminary screening tool for assessing the general magnitude of lateral spread displacements. If the results of these methods indicate minimal lateral displacements which can be accommodated by the bridge foundation elements, and bridge design performance levels are satisfied, no further lateral spread analysis is required.

**Semi-Empirical Approaches:** Methods in this step include those that are semi-empirical in approach and more geomechanics based, requiring assessment of liquefaction potential and incorporating the results of laboratory testing into a cumulative strain model. Each method estimates the permanent shear strains that are expected within the liquefied zones (and nonliquefied zones, if warranted) and then integrates those shear strains over depth to obtain an estimate of the potential lateral displacement at the ground surface. The estimated lateral



displacement may also be empirically adjusted on the basis of calibration to case history observations.

- Zhang et al. (2004)
- Idriss and Boulanger (2008)

**Newmark-Based Analysis:** The Newmark sliding-block approach consists of a seismic slope stability analysis that provides an estimate of seismically induced slope deformation (Jibson, 1993). In the Newmark time history analysis, lateral deformations are assumed to occur along a well-defined plane and the sliding mass is assumed to be a rigid block as shown in [Figure 13-13](#). In this analysis, a standard slope stability analysis is first conducted, using the post-earthquake undrained residual shear strengths of the liquefied soil, to determine the yield acceleration of the slide mass (the pseudo-static acceleration that results in a factor of safety of 1.0). When the earthquake accelerations exceed this yield acceleration threshold, the sliding mass displaces. The total displacement is computed by double integrating the area of the accelerogram that lies above the yield acceleration line and summing these displacements for the duration of the earthquake.

Several analytical methods based on the Newmark sliding block model have been developed to estimate deformations induced by earthquake cyclic loadings. These Newmark-type methods typically fall into one of the following categories, simplified Newmark charts or Newmark Time-History Analysis.

**Figure 13-13 Newmark Sliding Block Concept for Slopes (Kavazanjian, et al. (2011)).**

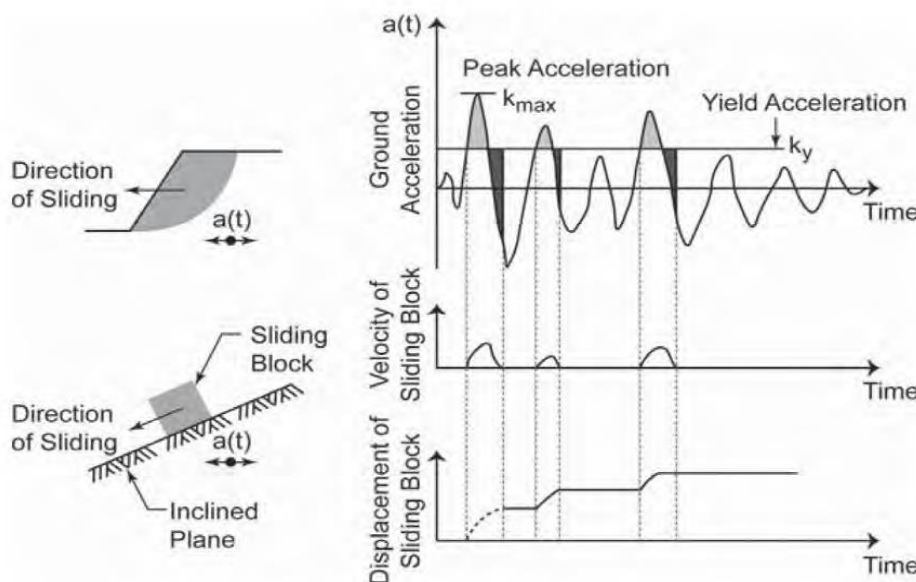

**Simplified Newmark Charts:** Simplified Newmark charts were developed based on a large database of earthquake records and the Newmark Time History Analysis method. These charts relate an acceleration ratio (the ratio of the yield acceleration to the peak acceleration occurring

at the base of the sliding mass) to horizontal ground displacement. The Newmark displacement method can also be performed using time history acceleration records if a site-specific seismic response is performed.

The simplified Newmark chart methods described in Anderson et al., (2008) and ATC-MCEER (2002) should be used for developing estimates of lateral spread displacements. These documents include worked examples and a discussion of which procedures are appropriate for specific conditions. Additional reference documents illustrating regional examples are provided in Dickenson et al., (2002) and Dickenson (2005).

The USGS computer program SLAMMER (Jibson, 2013), is also available to model slope performance during earthquakes using the Newmark method with various methods of analysis. This program allows for any combination of rigid-block, decoupled or fully coupled analysis to be conducted utilizing a large database of earthquake records. Simplified rigid-block analysis using empirical regression relationships to predict permanent displacements are also included.

The Newmark-based methods developed by Bray and Travararou, (2007) and Saygili and Rathje, (2008) may also be used, are included in the SLAMMER program, and are described briefly below.

- **Bray and Travararou, 2007:** This method is another modification, or enhancement, of the original Newmark sliding block model. It consists of a simplified, semi empirical approach for estimating permanent displacements due to earthquake-induced deviatoric deformations using a nonlinear, fully coupled, stick-slip sliding block model. In addition to estimating permanent displacements from rigid body slippage (basic Newmark approach) it also includes estimates of permanent displacement (deviatoric straining) from shearing within the sliding mass itself. The model can be used to predict the probability of exceeding certain permanent displacements or for estimating the displacement for a single deterministic event. This procedure is also available in EXCEL spreadsheet form.
- **Saygili and Rathje, 2008:** This method is another modification, or enhancement, of the original Newmark sliding block model, suitable for shallow sliding surfaces that can be approximated by a rigid sliding block. The model predicts displacements based on multiple ground motion parameters in an effort to reduce the standard deviation of the predicted displacements.

**Newmark Time History Analysis:** Newmark Time History Analysis is performed using the time history acceleration records developed from a site-specific ground response analysis. Note that in this type of analysis the yield acceleration is normally maintain at a constant value throughout the duration of the shaking. However, at sites with liquefiable soils the yield acceleration will be higher at the beginning of the analysis, before liquefaction has occurred, than at some time later in the record when cyclic degradation and strain softening has reduced the yield acceleration to lower values. In these cases, if the yield acceleration associated with partially, or fully, liquefied soil conditions is used throughout the analysis the resulting estimated displacements will be conservative.

The earthquake shaking that triggers the displacement is characterized by an acceleration record placed at the base of the sliding mass representing the design earthquake being evaluated. A minimum of seven independent earthquake records should be selected from a catalogue of earthquake records that are representative of the source mechanism, magnitude ( $M_w$ ), and site-to-source distance ( $R$ ). A sensitivity analysis of the input parameters used in the site-specific response analysis should be performed to evaluate its effect on the magnitude of the displacement computed. The results of the Newmark Time History Analyses should be compared with the results obtained using Simplified Newmark Charts.

The USGS computer program SLAMMER (Jibson, 2013), as described above, has the capability to perform time history Newmark analysis including decoupled and fully-coupled analysis of flexible sliding blocks.

**Numerical Modeling of Dynamic Slope Deformation:** Seismically induced slope deformations can also be estimated through a variety of dynamic stress-deformation computer models such as PLAXIS, DYNAFLOW, and FLAC. The accuracy of these models is highly dependent upon the quality of the input parameters. As the quality of the constitutive models used in dynamic stress-deformation models improves, the accuracy of these methods will improve. Another benefit of these models is their ability to illustrate mechanisms of deformation, which can provide useful insight into the proper input for simplified analyses.

Dynamic stress deformation models should not be used for routine design due to their complexity, and due to the sensitivity of the accuracy of deformation estimates from these models on the constitutive model selected and the accuracy of the input parameters. Use of dynamic stress-deformation computer models to evaluate seismically induced slope deformations requires the approval of the ODOT Bridge Section.

**Numerical Modeling Correlations (GMI):** In addition to the previously described empirical approaches, an additional simplified analysis method based on two dimensional numerical modeling of typical approach embankments using a finite difference computer code (FLAC) may be used as a screening and preliminary analysis tool for estimating lateral deformations of embankments over liquefied soils. This method, as presented in Dickenson et al. (2002), uses limit equilibrium methods to first calculate the post-earthquake factor of safety, using residual shear strengths in liquefied soils as appropriate. The resulting FOS is then used in combination with a Ground Motion Intensity ( $GMI = PGA/MSF$ ) parameter to estimate embankment displacements. The GMI was developed to account for the intensity and duration of the ground motions used in the FLAC analysis. This procedure is also useful for estimating the amount, or area, of ground improvement needed to limit displacements to acceptable levels.

### 13.5.4 Settlement of Dry Sand

Seismically induced settlement of unsaturated granular soils (dry sands) is well documented. Factors that affect the magnitude of settlement include the density and thickness of the soil deposit and the magnitude of seismic loading. The most common means of estimating the magnitude of dry sand settlement are through empirical relationships based on procedures similar to the Simplified Procedure for evaluating liquefaction susceptibility. The procedures

provided by Tokimatsu and Seed (1987) for dry sand settlement should be used. The Tokimatsu and Seed approach estimates the volumetric strain as a function of cyclic shear strain and relative density or normalized SPT  $N'_{60}$  values. The step-by-step procedure is presented in Geotechnical Engineering Circular No. 3 (Kavazanjian, et al., 2011).

## **13.5.5 Liquefaction Effects on Structure Foundations**

### **13.5.5.1 Bridge Approach Embankments**

All bridge approach embankments should be assessed for the potential of excessive embankment deformation (lateral displacement and settlement) due to seismic loading and the effects of these displacements on the stability and functional performance requirements of the bridge. This is true whether liquefaction of the foundation soils is predicted or not. As a general rule, for the CSZE event (Operational Level), up to one (1) foot of lateral and 6 to 12 inches of vertical embankment displacement can be used as a general guideline for determining adequate performance of bridge approach embankments. This range of displacements should be considered only as a general guideline for evaluating the final condition of the roadway surface and the ability to provide a minimum of one-lane access to the bridge for emergency response vehicles following the earthquake. Always keep in mind the accuracy of the methods used to predict embankment deformations.

Bridge approach embankments are also commonly required to provide passive soil resistance to lateral loads that are transferred from the bridge superstructure to bridge abutments during earthquake events. This resistance is primarily provided by the backfill materials behind the abutments backwalls. This is the case for either seat-type abutments or for integral abutments. Liquefaction of foundation soils can result in settlement and/or lateral deformation of the backfill soils which can greatly reduce the ability of the backfill materials to provide the required passive soil resistance. The geotechnical engineer should evaluate the potential for this condition to occur, the possible design impacts, and consult with the bridge designer to determine the backfill passive resistance design requirements.

Lateral displacement and fill settlement will also produce loads on the bridge foundation elements which should also be evaluated in terms of providing the required overall bridge stability and performance. Specific embankment displacement limits are not provided for the 1000-year event since under this level of shaking the bridge and approach fills are evaluated only in terms of meeting the “No-Collapse” criteria.

### **13.5.5.2 General Liquefaction Policies Regarding Bridge Foundations**

If liquefaction is predicted under either the 1000-year return or CSZE events, the effects of liquefaction on foundation design and performance must be evaluated. Soil liquefaction and the associated effects of liquefaction on foundation resistances and stiffness is generally assumed, in standard analyses, to be concurrent with the peak loads in the structure (i.e. no reduction in the transfer of seismic energy due to liquefaction and soil softening). This applies except for the

case where a site-specific nonlinear effective stress ground response analysis is performed which takes into account pore water pressure increases (liquefaction) and soil softening.

Liquefaction effects include:

- Reduced axial and lateral capacities and stiffness in deep foundations,
- Lateral spread, global instabilities and displacements of slopes and embankments,
- Ground settlement and possible downdrag effects.

The following design practice, related to liquefied foundation conditions, should be followed:

- **Spread Footings:** Spread footings are not recommended for bridge or abutment wall foundations constructed over liquefiable soils unless ground improvement techniques are employed that eliminate the potential liquefaction condition,
- **Piles and Drilled Shafts:** The tips of piles and drilled shafts shall be located below the deepest liquefiable soil layer. Friction resistance from liquefied soils should not be included in either compression or uplift resistance recommendations for the Extreme Event Limit I state loading condition. As stated above, liquefaction of foundation soils, and the accompanying loss of soil strength, is assumed to be concurrent with the peak loads in the structure. If applicable, reduced frictional resistance should also be applied to partially liquefied soils either above or below the predicted liquefied layer. Methods for this procedure are presented Dickenson et al. (2002).

**Pile Design Alternatives:** Obtaining adequate lateral pile resistance is generally the main concern at pier locations where liquefaction is predicted. Battered piles have sometimes performed poorly at locations of lateral spreading and if considered the pile head connection must be designed for adequate ductility and to accommodate possible displacement demands. Prestressed concrete piles have not been recommended in the past due to problems with excessive bending stresses at the pile-footing connection. Vertical steel piles are generally recommended in high seismic areas to provide the most flexible, ductile and cost-effective pile foundation system. Steel pipe piles often are preferred over H-piles due to their uniform section properties, versatility in driving either closed or open ended and their potential for filling with reinforced concrete. The following design alternatives should be considered for increasing group resistance or stiffness and the most economical design selected:

- Increase pile size, wall thickness (section modulus) and/or strength,
- Increase numbers of piles,
- Increase pile spacing to reduce group efficiency effects,
- Deepen pile cap and/or specify high quality backfill around pile cap for increase capacity and stiffness,
- Design pile cap embedment for fixed conditions,
- Ground improvement techniques.

**Liquefied P-y Curves:** Studies have shown that liquefied soils retain a reduced, or residual, shear strength and this shear strength may be used in evaluating the lateral capacity of foundation soils. In light of the complexity of liquefied soil behavior (including progressive strength loss, strain mobilization, and possible dilation and associated increase in soil stiffness)

computer programs commonly used for modeling lateral pile performance under liquefied soil conditions often rely on simplified relationships for soil-pile interaction. At this time, no consensus exists within the professional community on the preferred approach to modeling lateral pile response in liquefied soil.

The following three options described below are recommended for modeling liquefied soils in lateral load (p-y) analysis. Refer to Rollins et al., (2005), Ashford, et al., (2012) and the other references provided for additional information on modeling liquefied or partial liquefied soil conditions.

1. **P-multiplier Approach:** This method uses a static sand model and the P-multiplier approach as presented in Caltrans (2013). In this approach, p-multipliers ( $m_p$ ) are applied to the non-liquefied sand p-y curves to obtain the equivalent p-y curves for liquefied soil. Mid-range values of p-multipliers from the Brandenburg (2005) study, as shown on [Figure 13-14](#), are recommended.
2. **Soft Clay Criteria:** This method, proposed by Wang and Reese (1998), utilizes p-y curves generated using the soft clay criteria (Matlock, 1970) with the undrained shear strength of the clay replaced by the residual shear strength of liquefied sand. It is recommended that  $\varepsilon_{50} = 0.05$  be used when applying the soft clay procedure.
3. **Modified Sand Model:** This method modifies the static sand model(s) in the LPILE, or equivalent, program by using a reduced soil friction angle to represent the reduced, or residual shear strength of the liquefied soil. The reduced soil friction angle is calculated using the inverse tangent of the residual undrained shear strength divided by the effective vertical stress at the depth where the residual shear strength was determined or measured. The equation is:

#### Equation 13-2

$$\varphi_{\text{reduced}} = \tan^{-1} (S_r / \sigma'_{v0}),$$

Where  $S_r$  is the residual shear strength and  $\sigma'_{v0}$  is the effective vertical stress.

Parameters representing the initial stiffness of the P-Y curves also need to be reduced in a manner similar to the reduction applied to obtain  $P_{\text{ultliq}}$ . For the DFSAP computer program, this adjustment to liquefied conditions would be applied to  $E_{50}$ . For the L-Pile and Group programs, this adjustment would be applied to the modulus of subgrade reaction,  $k$ . For both approaches, the soil unit weight should not be adjusted for liquefied conditions.

Note that for partially liquefied conditions, the p-multipliers in Option 1 can be increased from those values shown in [Figure 13-14](#), linearly interpolating between the values taken from the curves and 1.0, based on the pore pressure ratio,  $r_u$ , achieved during shaking (e.g., Dobry, et al., 1995). For Options 2 and 3, partially liquefied shear strengths may be used to calculate the reduced  $P_{\text{ultliq}}$  and corresponding p-y curves.

Other procedures can be used with approval by ODOT.

The modified soil parameters representing liquefied, or partially liquefied, soil conditions may be applied to either of the LPILE GROUP, DFSAP or equivalent static soil models. DFSAP has an option built in to the program for estimating liquefied lateral stiffness parameters and lateral spread loads on a single pile or shaft. However, it should be noted the accuracy of the liquefied soil stiffness and predicted lateral spread loads using strain wedge theory, in particular the DFSAP program, has not been well established and is not recommended at this time. Liquefied sand p-y curves, based on full scale lateral load testing, are also available in the LPILE and GROUP computer programs. This load test study (Ashford, et al., 2002) produced p-y curves for liquefied sand conditions that are fundamentally different than those derived from the standard static p-y curve models. The use of these liquefied p-y curves is not recommended at this time until further studies are completed and a consensus is reached on the use of these p-y curves in practice.

**Figure 13-14 p-multiplier (mp) vs. clean sand equivalent corrected blow count, (N<sub>1</sub>)<sub>60CS</sub>, from a variety of studies. (Ashford et al., 2012)**

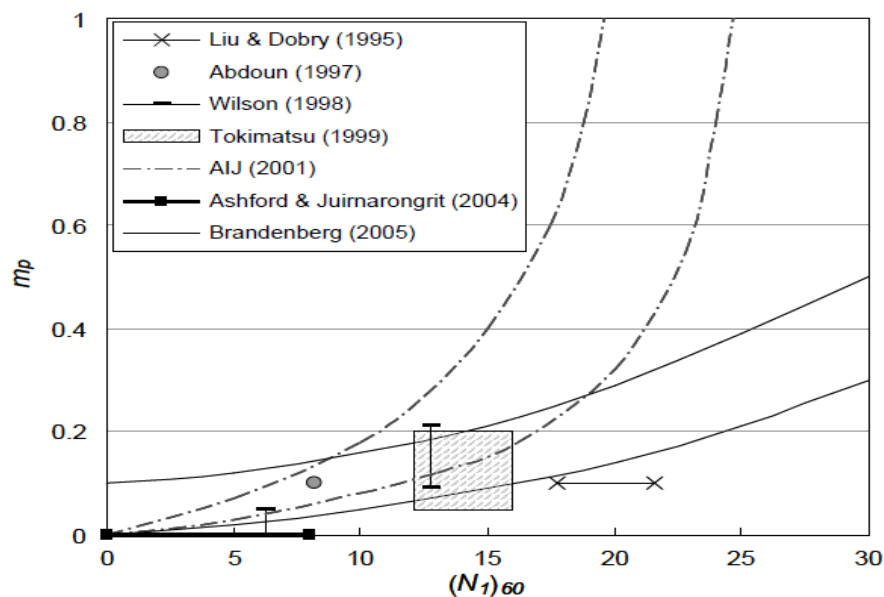

For pile or shaft groups within fully liquefied conditions, P-y curve group reduction factors may be set to 1.0. For partially liquefied conditions, the group reduction factors shall be consistent with the group reduction factors used for static loading.

**T-Z curves:** Modify either the PL/AE method or APILE Plus program as follows:

- For the PL/AE method, if the liquefied zone reduces total pile skin friction to less than 50% of the nominal bearing resistance, use “end bearing” condition (i.e. full length of pile) in stiffness calculations. Otherwise use “friction” pile condition.

- For the APile program, use the methods described for P-y curves to develop t-z (axial) or q-z (tip) stiffness curves for liquefiable soil layers.

**Settlement and Downdrag Loads:** Settlement of foundation soils due to the liquefaction or dynamic densification of unsaturated cohesionless soils could result in downdrag loads on foundation piling or shafts. Refer to Section 3.11.8 of *AASHTO (2014)* for guidance on designing for liquefaction-induced downdrag loads. Refer to [Chapter 16](#) for guidance on including seismic-induced settlement and downdrag loads on the seismic design of pile and shaft foundations.

### 13.5.5.3 Lateral Spread and Flow Failure Loads on Structures

In general, there are two different approaches to estimate the induced load on deep foundations systems due lateral spreading or flow failures— a displacement based approach and a force based approach. Displacement based approaches are more prevalent in the United States. The force based approach has been specified in the Japanese codes and is based on case histories from past earthquakes, especially the pile foundation failures observed during the 1995 Kobe earthquake. Overviews of both approaches are presented in the following sections.

### 13.5.5.4 Displacement Based Approach

The recommended displacement based approach for evaluating the impact of liquefaction induced lateral spreading and flow failure loads on deep foundation systems is presented in the ODOT research report titled, “*Reducing Seismic Risk to Highway Mobility: Assessment and Design Examples for Pile Foundations Affected by Lateral Spreading*”, (Ashford, et. al., 2012). This approach provides methods to evaluate deep foundation systems that partially restrain the ground movement caused by lateral spreading/flow failure, and those foundation systems in which the ground can freely flow around them. Additional guidance on these procedures, including step-by-step design examples, are presented in Caltrans (2013). To be consistent with the design provisions in this GDM, the procedures described in Ashford, et. al., (2012) shall be modified as follows:

- Evaluate the liquefaction potential and lateral spread foundation load effects for both the 1000-year return event and the CSZE (if appropriate),
- Assessment of liquefaction potential shall be in accordance with [Chapter 7](#),
- Determination of liquefied residual strengths shall be in accordance with [Chapter 7](#),
- Lateral spread deformations shall be estimated using methods provided in [Chapter 7](#)
- Deep foundation springs shall be determined using [Chapter 7](#),
- Foundation performance shall meet the requirements in [Chapter 7](#),
- Foundation moment and displacement demands shall meet the requirements specified in the ODOT BDM. In-ground hinging and plastic failure of piles or shafts due to lateral spread and slope failures is not permitted on ODOT bridge projects for either the Life Safety or Operational performance level evaluations.



In cases where a significant crust of non-liquefiable material may exist, the foundation is likely to continue to move with the soil. Since large-scale structural deformations may be difficult and costly to accommodate in design, mitigation of foundation sub-soils will likely be required.

### 13.5.5.5 Force Based Approaches

A force-based approach to assess lateral spreading induced loads on deep foundations is specified in the Japanese codes. The method is based on back-calculations from pile foundation failures caused by lateral spreading. Refer to Yokoyama, et al., (1997) for background on this method. The pressures on pile foundations are simply specified as follows:

- The liquefied soil exerts a pressure equal to 30 percent of the total overburden pressure (lateral earth pressure coefficient of 0.30 applied to the total vertical stress) to each foundation element in the foundation group,
- Non-liquefied crustal layers exert full passive pressure on the foundation system.

Data from simulated earthquake loading of model piles in liquefiable sands in centrifuge tests indicate that the Japanese force method is an adequate design method (Finn, et al, 2004) and therefore may be used to estimate lateral spreading and flow failure forces on bridge foundations.

### 13.5.6 Mitigation Alternatives

The two basic options to mitigate lateral spread or flow failure induced loads on the foundation system are to design the structure to accommodate the loads or improve the ground such that the hazard does not occur.

**Structural Options (design to accommodate imposed loads):** Refer to [Chapter 7](#) for more details on the specific analysis procedures for structural design mitigation options. The results of either the displacement or force-based approaches should be used to determine if it is feasible and economical for the structure to accommodate the estimated forces and/or displacements and provide the required design performance. Multiple design iterations may be required in this assessment. It is sometimes cost prohibitive to design the bridge foundation system to resist the loads imposed by liquefaction induced lateral spreading, especially if the depth of liquefaction extends more than about 20 feet below the ground surface and if a non-liquefied crust is part of the failure surface. If an acceptable level of design performance is not achievable through the structural option, then ground improvement should be considered.

**Ground Improvement:** The need for ground improvement techniques to mitigate liquefaction effects depends, in part, upon the type and amount of anticipated damage to the structure and approach fills due to the effects of liquefaction and embankment deformation (both horizontal and vertical). The performance criteria described in [Chapter 7](#) should be followed. Ground improvement methods are described in Elias et al. (2006) and [Chapter 14](#). All ground improvement designs required to mitigate the effects of soil liquefaction shall be reviewed by the Bridge Section.

If, under the Operational performance level evaluation, the estimated bridge damage, or the estimated bridge approach fill displacements, are sufficient to render the bridge out of service for one lane of emergency traffic then ground improvement measures should be considered. If, under the 1000-year event, estimated bridge damage results in the possible collapse of a portion or all of the structure then ground improvement is required. A flow chart of the ODOT Liquefaction Mitigation Procedures is provided in [Appendix 13-B](#).

Ground improvement techniques should result in reducing estimated ground and embankment displacements to acceptable levels. Mitigation of liquefiable soils beneath approach fills should extend a distance away, in both longitudinal and transverse directions, from the bridge abutment sufficient enough to limit lateral embankment displacements to acceptable levels. As a general rule of thumb, foundation mitigation should extend at least from the toe of the bridge end slope (or face of abutment wall) to the point where a 1:1 slope extending from the back of the bridge end panel intersects the original ground ([Figure 13-15](#)). The final limits of the mitigation area required should be determined from iterative slope stability analysis and consideration of ground deformations.

**Figure 13-15 Extent of Ground Improvement for Liquefaction Mitigation**

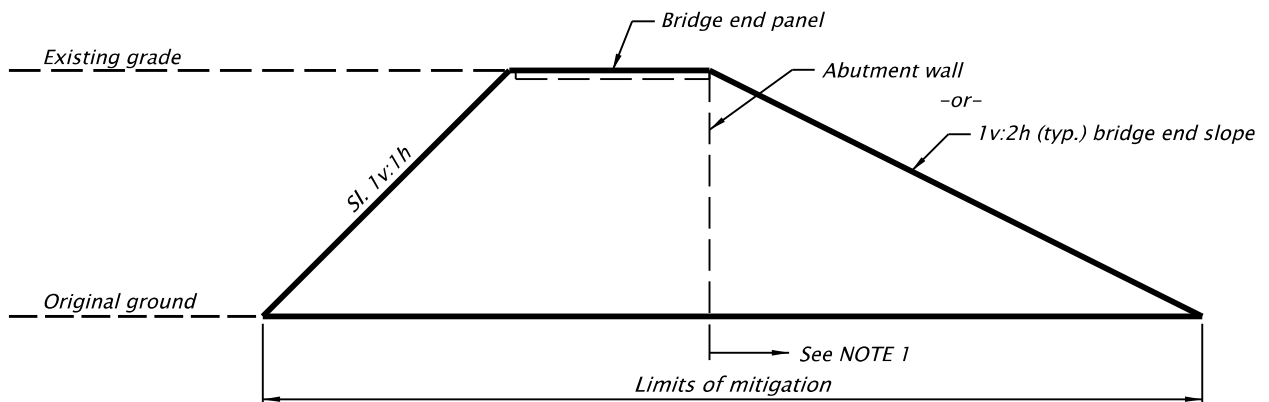

*NOTE 1: Extend ground improvement beyond the abutment face as needed for design.*

Ground improvement techniques should also be considered as part of any Phase II (substructure & foundation) seismic retrofit process. All Phase II retrofit structures should be evaluated for liquefaction potential and mitigation needs. The cost of liquefaction mitigation for retrofitted structures should be assessed relative to available funding.

The primary ground improvement techniques to mitigate liquefaction fall into three general categories, namely densification, altering the soil composition, and enhanced drainage. A general discussion regarding these ground improvement approaches is provided below. Refer to GDM [Chapter 12](#) for a more detailed discussion regarding the use and design of these and other ground improvement mitigation techniques.

- **Densification and Reinforcement:** Ground improvement by densification consists of sufficiently compacting the soil such that it is no longer susceptible to liquefaction during a design seismic event. Densification techniques include vibro-compaction, vibro-flotation, vibro-replacement (stone columns), deep dynamic compaction, blasting, and compaction grouting. Vibro-replacement and compaction grouting also reinforce the soil by creating columns of stone and grout, respectively. The primary parameters for selection include grain size distribution of the soils being improved, depth to groundwater, depth of improvement required, proximity to settlement/vibration sensitive infrastructure, and access constraints.
- **Altering Soil Composition:** Altering the composition of the soil typically refers to changing the soil matrix so that it is no longer susceptible to liquefaction. Examples of ground improvement techniques include permeation grouting (either chemical or micro-fine cement), jet grouting, and deep soil mixing. These types of ground improvement are typically more costly than the densification/reinforcement techniques, but may be the most effective techniques if access is limited, construction induced vibrations must be kept to a minimum, and/or the improved ground has secondary functions, such as a seepage barrier or shoring wall.
- **Drainage Enhancements:** By improving the drainage properties of sandy soils susceptible to liquefaction, it may be possible to reduce the build-up of excess pore water pressures, and thus liquefaction during seismic loading. However, drainage improvement is not considered adequately reliable by ODOT to prevent excess pore water pressure buildup due to the length of the drainage path, the time for pore pressure to dissipate, the influence of fines on the permeability of the sand, and due to the potential for drainage structures to become clogged during installation and in service. In addition, with drainage enhancements some settlement is still likely. Therefore, drainage enhancements alone shall not be used as a means to mitigate liquefaction.

Geotechnical engineers are encouraged to work with ground treatment contractors having regional experience in the development of soil improvement strategies for mitigating hazards due to permanent ground deformation.

## 13.6 Input for Structural Design

### 13.6.1 Foundation Springs

Structural dynamic response analyses incorporate the foundation stiffness into the dynamic model of the structure to capture the effects of soil structure interaction. The foundation stiffness is typically represented as a system of equivalent springs placed in a foundation stiffness matrix. The typical foundation stiffness matrix incorporates a set of six primary springs to describe stiffness with respect to three translational and three rotational components of motion. Springs that describe the coupling of horizontal translation and rocking modes of deformation may also be used.

The primary parameters for calculating the individual spring stiffness values are the foundation type (shallow spread footings or deep foundations), foundation geometry, design ground motions, and soil parameters such as dynamic soil shear modulus, Poisson's ratio, nominal bearing resistance, p-y curves and other parameters depending on foundation type. Refer to the *ODOT BDM* for additional information on foundation modeling methods and the soil/rock design parameters required by the structural designer for the analysis. Additional guidance on the development of foundation springs can be found in Kavazanjian et. al., (2011) and Marsh, et. al., (2011) and their companion reports containing worked design examples.

### 13.6.1.1 Shallow Foundations

For evaluating shallow foundation springs, the structure designer generally requires values for the dynamic shear modulus,  $G$ , Poisson's ratio, and the unit weight of the foundation soils. The maximum, or low-strain, shear modulus can be estimated using index properties and the correlations presented in Table 13.2. Alternatively, the maximum shear modulus can be calculated using Equation 13.3, if the shear wave velocity is known:

**Equation 13-3**

$$G_{\max} = \gamma / g(V_s)^2$$

Where:

$G_{\max}$  = maximum dynamic shear modulus

$\gamma$  = soil unit weight

$V_s$  = shear wave velocity

$g$  = acceleration due to gravity

The maximum dynamic shear modulus ( $G_{\max}$ ) is associated with very small shear strains (less than 0.0001 percent). As the seismic ground motion level increases, the soil shear strain level increases and the dynamic shear modulus decreases. The effective shear modulus,  $G$ , to be used in developing shallow foundation springs, should be developed in accordance with AASHTO (2015) using the methods described in FEMA 356 (ASCE 2000). Table 4.7 in this document reflects the dependence of  $G$  on both the shear strain induced by the ground motion and on the soil type (i.e.,  $G$  drops off more rapidly as shear strain increases for softer or looser soils).

As an alternative, if a detailed site specific ground response analysis is conducted, either [Figures 13-1](#) and [13-2](#) may be used to estimate  $G$  in consideration of the shear strains predicted through the ground response analysis. An effective shear strain, equal to 65 percent of the peak shear strain, should be used in this analysis. Laboratory test results may also be used to determine the relationship between  $G/G_{\max}$  and shear strain.

Poisson's Ratio should be estimated based on soil type, relative density/consistency of the soils, and correlation charts such as those presented in Foundation Analysis and Design (Bowles, 1996).

### **13.6.1.2 Deep Foundations**

Lateral soil springs for deep foundations shall be determined in accordance with [Chapter 16](#). Refer to [Chapter 7](#) for guidance on modifying t-z curves and the soil input required for P-y curves representing liquefied or partially liquefied soils.

### **13.6.1.3 Downdrag Loads on Structures**

Downdrag loads on foundations shall be determined in accordance with [Chapter 16](#).

## 13.7 References

- AASHTO, 2014. "AASHTO LRFD Bridge Design Specifications", 7th Edition and Interim Revisions, American Association of State Highway and Transportation Officials, Washington, D.C. (Note: most current edition shall be used)
- AASHTO, 2011. "AASHTO Guide Specifications for LRFD Seismic Bridge Design", 2nd Edition and Interim Revisions, American Association of State Highway and Transportation Officials, Washington, D.C. (Note: most current edition shall be used)
- Anderson, D. G., Martin, G. R., Lam, I. P., and Wang, J. N., 2008. "Seismic Analysis and Design of Retaining Walls, Buried Structures, Slopes, and Embankments", NCHRP Report 611 (Project 12-70), Transportation Research Board, Washington, D. C.
- ASCE, 2000, "Pre-standard and Commentary for the Seismic Rehabilitation of Buildings", Federal Emergency Management Agency, FEMA 356, 518 pp.
- Ashford, S.A., Scott, M.H., and Rayamajhi, D., 2012. "Reducing Seismic Risk to Highway Mobility: Assessment and Design Examples for Pile Foundations Affected by Lateral Spreading", ODOT Research Report OR-RD-13-09, Oregon Department of Transportation.
- ATC-MCEER Joint Venture, 2002. "Comprehensive Specification for the Seismic Design of Bridges", NCHRP Report 472, National Cooperative Highway Research Program, Washington DC.
- Boulanger, R.W. and Idriss, I.M., 2014. "CPT and SPT Based Liquefaction Triggering Procedures", Center for Geotechnical Modeling, Report UCD/CGM-14/01, Dept. Civil & Environmental Engineering, Univ. of California, Davis.
- Boulanger, R. W. and Idriss, I. M., 2006. "Liquefaction Susceptibility Criteria for Silts and Clays", ASCE Journal of Geotechnical and Geoenvironmental Engineering, Vol. 132, No. 11, pp. 1413-1426.
- Bowles, J.E., 1996. "Foundation Analysis and Design", Fifth Edition. The McGraw-Hill Companies, Inc., New York.
- Brandenburg, S. J., Boulanger, R. W., Kutter, B. L., and Chang, D., 2007, "Static Pushover Analyses of Pile Groups in Liquefied and Laterally Spreading Ground in Centrifuge Tests", ASCE Journal of Geotechnical and Geoenvironmental Engineering, Vol. 133, No. 9, pp. 1055-1066.
- Brandenburg, S.J. (2005). "Behavior of Pile Foundations in Liquefied and Laterally Spreading Ground", PhD dissertation, Dept. of Civil and Envir. Engrg., Univ. of Calif., Davis, CA.
- Bray, J. D., and Sancio, R. B., 2006. "Assessment of the Liquefaction Susceptibility of Fine-Grained Soil", ASCE Journal of Geotechnical and Geoenvironmental Engineering, Vol. 132, No. 9, pp. 1165-1176.
- Bray, J. D., and Travasarou, T., 2007. "Simplified Procedure for Estimating Earthquake-Induced Deviatoric Slope Displacements", ASCE Journal of Geotechnical and Geoenvironmental Engineering, Vol. 133, No. 4, pp. 381-392.

- Buckle, I., Friedland, I., Mander, J., Martin, G., Nutt, R., Power, M., 2006. "Seismic Retrofitting Manual for Highway Structures: Part 1 – Bridges". *Report No. FHWA-HRT-06-032*, U.S. Department of Transportation, Washington, D.C.
- Caltrans, 2012. "[Guidelines on Foundation Loading and Deformation Due to Liquefaction Induced Lateral Spreading](#)", Caltrans internal design guideline report, Sacramento, CA.
- Cetin, K., Bilge, H., Wu, J., Kammerer, A., and Seed, R., 2009. "Probabilistic Model for the Assessment of Cyclically Induced Reconsolidation (Volumetric) Settlements", *ASCE Journal of Geotechnical & Geoenvironmental Engineering*, 135(3), 387 – 398.
- Cetin, K.O., Seed, R.B., Der Kiureghian, A., Tokimatsu, K., Harder, L.F., Kayen, R.E., and Moss, R.E.S., 2004. "Standard Penetration Test-Based Probabilistic and Deterministic Assessment of Seismic Soil Liquefaction Potential", *ASCE Journal of Geotechnical and Geoenvironmental Engineering*, 130(12), 1314-1340.
- Darendeli, M., 2001, "Development of a New Family of Normalized Modulus Reduction and Material Damping Curves", *Ph.D. Dissertation*, Department. of Civil Engineering, University of Texas, Austin, 362 pp.
- Dickenson, S., McCullough, N., Barkau, M. and Wavra, B., 2002. "[Assessment and Mitigation of Liquefaction Hazards to Bridge Approach Embankments in Oregon](#)", Final Report SPR 361, Oregon Department of Transportation.
- Dickenson, S., 2005. "[Recommended Guidelines for Liquefaction Evaluations Using Ground Motions from Probabilistic Seismic Hazard Analysis](#)", Report to Oregon Department of Transportation.
- Dobry, R., Taboada, V, and Liu, L., 1995. "Centrifuge Modeling of Liquefaction Effects During Earthquakes", *Proc. 1st Intl. Conf. On Earthquake Geotechnical Engineering*, K. Ishihara, ed., Tokyo, Japan, Vol. 3, pp. 1291-1324.
- Dusicka, Peter and Lopez, Alvaro, 2016. "Impact of Cascadia Subduction Zone Earthquake on the Evaluation Criteria of Bridges", Report to Oregon Department of Transportation.
- Electrical Power Research Institute (EPRI), 1993. "Guidelines for Determining Design Basis Ground Motions", *Electrical Power Research Institute*, Palo Alto, CA, November-TR-102293.
- Elias, V., Welsh, J., Warren, J., Lukas, R., Collin, J.G., and Berg, R.R., 2006. "Ground Improvement Methods, Volumes I and II", *FHWA NHI-06-019 and FHWA NHI-06-020*, US Dept. of Transportation, Federal Highway Administration.
- Finn, W.D. Liam and Fujita, N., 2004. "Behavior of Piles in Liquefiable Soils during Earthquakes: Analysis and Design Issues". *Proceedings: Fifth International Conference on Case Histories in Geotechnical Engineering*, New York, New York, April 13-17, 2004.
- Peterson, M.D., Moschetti, M.P., Powers, P.M., Mueller, C. S., Haller, K.M., Frankel, A.D., Zeng, Y., Rezaeian, S., Harmsen, S.C., Boyd, O.S., Field, N., Chen, R., Rukstales, K.S., Luco, N., Wheeler, R.L., Williams, R.A. and Olsen, A.H., "Documentation for the 2014 Update of

the United States National Seismic Hazard Maps”, Open-File Report 2014-1091, U.S. Department of Interior, U.S. Geological Survey.

- Ghafghazi, M., Thurairajah, A., DeJong, J., Wilson, D., and Armstrong, R. (2014). “Instrumented Becker Penetration Test for Improved Characterization of Gravelly Deposits”, *Proc. of Geo-Congress 2014: Geo-Characterization and Modeling for Sustainability*, ASCE, Geotechnical Special Publication 234, 37 – 46.
- Idriss, I. M., and Boulanger, R. W. (2007). “SPT- and CPT-Based Relationships for the Residual Shear Strength of Liquefied Soils”, *Earthquake Geotechnical Engineering, 4th International Conference on Earthquake Geotechnical Engineering*, Invited Lectures, K. D. Pitilakis, ed., Springer, The Netherlands, 1-22.
- Idriss, I. M., and Boulanger, R. W., 2008, “Soil Liquefaction During Earthquakes”, *EERI Monograph MNO-12*, Earthquake Engineering Research Institute (EERI)
- International Code Council, Inc., 2012. “2012 International Building Code”. Country Club Hills, IL. (most current version shall be used).
- International Code Council, Inc., 2014. “2014 Oregon Structural Specialty Code”. Whittier, CA. (most current version shall be used).
- Ishihara, K., and Yoshimine, M., 1992. “Evaluation of Settlements in Sand Deposits Following Liquefaction During Earthquakes”, *Japanese Society of Soil Mechanics and Foundation Engineering*, Soils and Foundations, Vol. 32, No. 1, pp. 173-188.
- Jibson R.W., (1993). “Predicting Earthquake Induced Landslide Displacements Using Newmark’s Sliding Block Analysis”, *Transportation Research Record, No. 1411- Earthquake Induced Ground Failure Hazards*, Transportation Research Board, National Research Council, Washington, D.C.
- Jibson, R.W., Rathje, E.M., Jibson, M.W. and Lee, Y.W., 2013. “SLAMMER - Seismic Landslide Movement Modeled Using Earthquake Records – User Guide”, *Excerpt from USGS Methods and Techniques: Series 12-B1*, US Geological Survey, Reston, VA.
- Kavazanjian, E., Jr., Wang, J-N., Martin, G.R., Shamsabadi, A., Lam, I.P., Dickenson, S.E., and Hung, C.J., 2011. “Geotechnical Engineering Circular No. 3, LRFD Seismic Analysis and Design of Transportation Geotechnical Features and Structural Foundations”, *Report No. FHWA-NHI-11-032*, National Highway Institute, Washington, D.C.
- Kavazanjian, E., Jr., Wang, J-N., Martin, G.R., Shamsabadi, A., Lam, I.P., Dickenson, S.E., and Hung, C.J., 2011. “Geotechnical Engineering Circular No. 3, LRFD Seismic Analysis and Design of Transportation Geotechnical Features and Structural Foundations, Design Examples”, *Report No. FHWA-NHI-11-075*, National Highway Institute, Washington, D.C.
- Kramer, S.L., 1996. “Geotechnical Earthquake Engineering”. Prentice-Hall, Inc., Upper Saddle River, NJ.



- Kramer, S.L. and Paulsen, S.B., 2004. "Practical Use of Geotechnical Site Response Models", *Proceedings; International Workshop on Uncertainties in Nonlinear Soil Properties and their Impact on Modeling Dynamic Soil Response*. University of California, Berkeley, CA. March 18-19, 2004.
- Kramer, S. L., 2008. "Evaluation of Liquefaction Hazards in Washington State", Washington State Department of Transportation, Report WA-RD 668.1.
- Lee, M. and Finn, W., 1978. "DESRA-2, Dynamic Effective Stress Response Analysis of Soil Deposits with Energy Transmitting Boundary Including Assessment of Liquefaction Potential". *Soil Mechanics Series No. 38*, Dept. of Civil Engineering, University of British Columbia, Vancouver, B.C.
- Marsh, M.L., Buckle, I.G. and Kavazanjian, E.Jr., 2014. "NHI Course 130093 and 130093A, LRFD Seismic Analysis and Design of Bridges, Reference Manual", Report No. FHWA NHI-15-004, National Highway Institute, Washington, D.C.
- Matasovic, N. and Hashash, Y. (2012), "Practices and Procedures for Site-Specific Evaluations of Earthquake Ground Motions", *NCHRP Synthesis 428*, National Cooperative Highway Research Program, Transportation Research Board, Washington, D.C.
- Matlock, H. (1970). "Correlations for Design of Laterally Loaded Piles in Soft Clay". *Proc. Offshore Technology Conference*, Houston, TX, Vol. 1, No. 1204, pp. 577-594.
- Mayne, P.W., 2007. "Cone Penetrometer Testing, A Synthesis of Highway Practice", *NCHRP Synthesis 368*, Transportation Research Board, Washington, D. C.
- Moss, E.S., Seed, R.B., Kayen, R.E., Stewart, J.P., Der Kiureghian, A., and Cetin, K.O., 2006. "CPT-Based Probabilistic and Deterministic Assessment of In-situ Seismic Soil Liquefaction Potential", *ASCE Journal of Geotechnical and Geoenvironmental Engineering*, 132(8), 1032-1051.
- Newmark, N.M., 1965. "Effects of Earthquakes on Dams and Embankments", *Geotechnique* 15(2), pp. 139-160.
- Olson, S.M. and Johnson, C.I. (2008), "Analyzing Liquefaction-Induced Lateral Spreads Using Strength Ratios", *ASCE Journal of Geotechnical and Geoenvironmental Engineering*, Volume 134, Issue 8, pp. 1035-1049.
- Oregon Department of Transportation, 2004, [Bridge Design Manual](#). (most current edition)
- Ordoñez, G.A., 2011. "Shake 2000, Computer Program for the 1D Analysis of Geotechnical Earthquake Engineering Problems", <http://www.geomotions.com>
- Petersen, M.D., Moschetti, M.P., Powers, P.M., Mueller, C.S., Haller, K.M., Frankel, A.D., Zeng, Yuehua, Rezaeian, Sanaz, Harmsen, S.C., Boyd, O.S., Field, Ned, Chen, Rui, Rukstales, K.S., Luco, Nico, Wheeler, R.L., Williams, R.A., and Olsen, A.H., 2014, Documentation for the 2014 update of the United States national seismic hazard maps: U.S. Geological Survey Open-File Report 2014-1091, 243 p., <https://doi.org/10.3133/ofr20141091>
- Rauch, A. F., and Martin, J. R., Jr. (2000). "EPOLLS Model for Predicting Average Displacements on Lateral Spreads". *ASCE Journal of Geotechnical and Geoenvironmental Engineering*, 126(4).

- Rollins, K.M., Gerber, T.M., Lane, J.D., Ashford, S.A., 2005. "Lateral Resistance of a Full-Scale Pile Group in Liquefied Sand", *ASCE Journal of Geotechnical & Geoenvironmental Engineering*, Vol. 131 Issue 1, p115-125.
- Sabatini, P.J., Bachus, R.C., Mayne, P.W., Schneider, J.A., and Zettler, T.E., 2002. "[Geotechnical Engineering Circular No. 5, Evaluation of Soil and Rock Properties](#)", Report No. FHWA-IF-02-034, U.S. Department of Transportation, Federal Highway Administration, Washington, D.C.
- Saygili, G., and Rathje, E. M., 2008, "Empirical Predictive Models for Earthquake-Induced Sliding Displacements of Slopes", *ASCE Journal of Geotechnical and Geoenvironmental Engineering*, Vol. 134, No. 6, pp. 790-803.
- Seed, H.B. and Idriss, I.M., 1971. "Simplified Procedure for Evaluating Soil Liquefaction Potential", *ASCE Journal of Soil Mechanics and Foundations Division*, Vol. 97, No. SM9, pp. 1249-1273.
- SCDOT, 2010, "Geotechnical Design Manual", Version 1.1, South Carolina Department of Transportation, Columbia, SC.
- Tokimatsu, K. and Seed, H.B., 1987. "Evaluation of Settlement in Sands Due to Earthquake Shaking", *ASCE Journal of Geotechnical Engineering*, Vol. 113, No. 8, August 1987.
- Tsukamoto, Y., and Ishihara, K., 2010. "Analysis on Settlement of Soil Deposits following Liquefaction during Earthquakes", *Soils and Foundations, Japanese Geotechnical Society*, 50(3), 399-411.
- Vucetic, M. and Dobry, R. (1991). "Effect of Soil Plasticity on Cyclic Response". *ASCE Journal of Geotechnical Engineering*, Vol. 117, No. 1, pp. 89-107.
- Wair, B.R., DeJong, J.T., and Shantz, T., 2012. "Guidelines for Estimation of Shear Wave Velocity Profiles", *PEER Report 2012/08*, Pacific Earthquake Engineering Research Center.
- Wang, S.-T., and Reese, L. C. (1998). "Design of Pile Foundations in Liquefied Soils", *Geotechnical Earthquake Engineering and Soil Dynamic III, GSP No. 75*, P. Dakoulas and M. Yegian, eds., Vol. 2, ASCE, Reston, Va., 1331-1343.
- Yokoyama, K., Tamura, K., and Matsuo, O., 1997, "Design Methods of Bridge Foundations against Soil Liquefaction and Liquefaction-induced Ground Flow", *Proc. 2<sup>nd</sup> Italy-Japan Workshop on Seismic Design and Retrofit of Bridges*, Rome, Italy, pp. 109-131.
- Youd, T.L.; Idriss, I.M.; Andrus, R.D.; Arango, I.; Castro, G.; Christian, J.T.; Dobry, R.; Finn, W.D.; Harder, L.; Hynes, M.E.; Ishihara, K.; Koester, J.P.; Liao, S.S.C.; Marcuson, W.F.; Martin, G.R.; Mitchell, J.K.; Moriwaki, Y.; Power, M.S.; Robertson, P.K.; Seed, R.B. and Stokoe, K.H., 2001. "Liquefaction Resistance of Soils: Summary Report from the 1996 NCEER and 1998 NCEER/NSF Workshops on Evaluation of Liquefaction Resistance of Soils", *ASCE Journal of Geotechnical and Geoenvironmental Engineering*, Vol. 127, No. 10, pp. 817-833.

- Youd, T.L.; Hansen, C.M. and Bartlett, S.F., 2002. "Revised Multilinear Regression Equations for Prediction of Lateral Spread Displacement", *ASCE Journal of Geotechnical and Geoenvironmental Engineering*, Vol. 128, No. 12, pp. 1007-1017.
- Zhang, G., Robertson, P. K., Brachman, R. W. I., 2002, "Estimating Liquefaction-induced Ground Settlements from CPT for Level Ground", *Canadian Geotechnical Journal*, 39, 1168-1180.
- Zhang, G., Robertson, P. K., Brachman, R. W. I., 2004, "Estimating Liquefaction- Induced Lateral Displacements Using the Standard Penetration Test or Cone Penetration Test", *ASCE Journal of Geotechnical and Geoenvironmental Engineering*, Vol. 130, No. 8, pp. 861-871.

# Appendix 13-A Flow chart for evaluation of liquefaction hazard and ground deformation at bridge sites

## FLOW CHART FOR EVALUATION OF LIQUEFACTION HAZARD AND GROUND DEFORMATION AT BRIDGE SITES

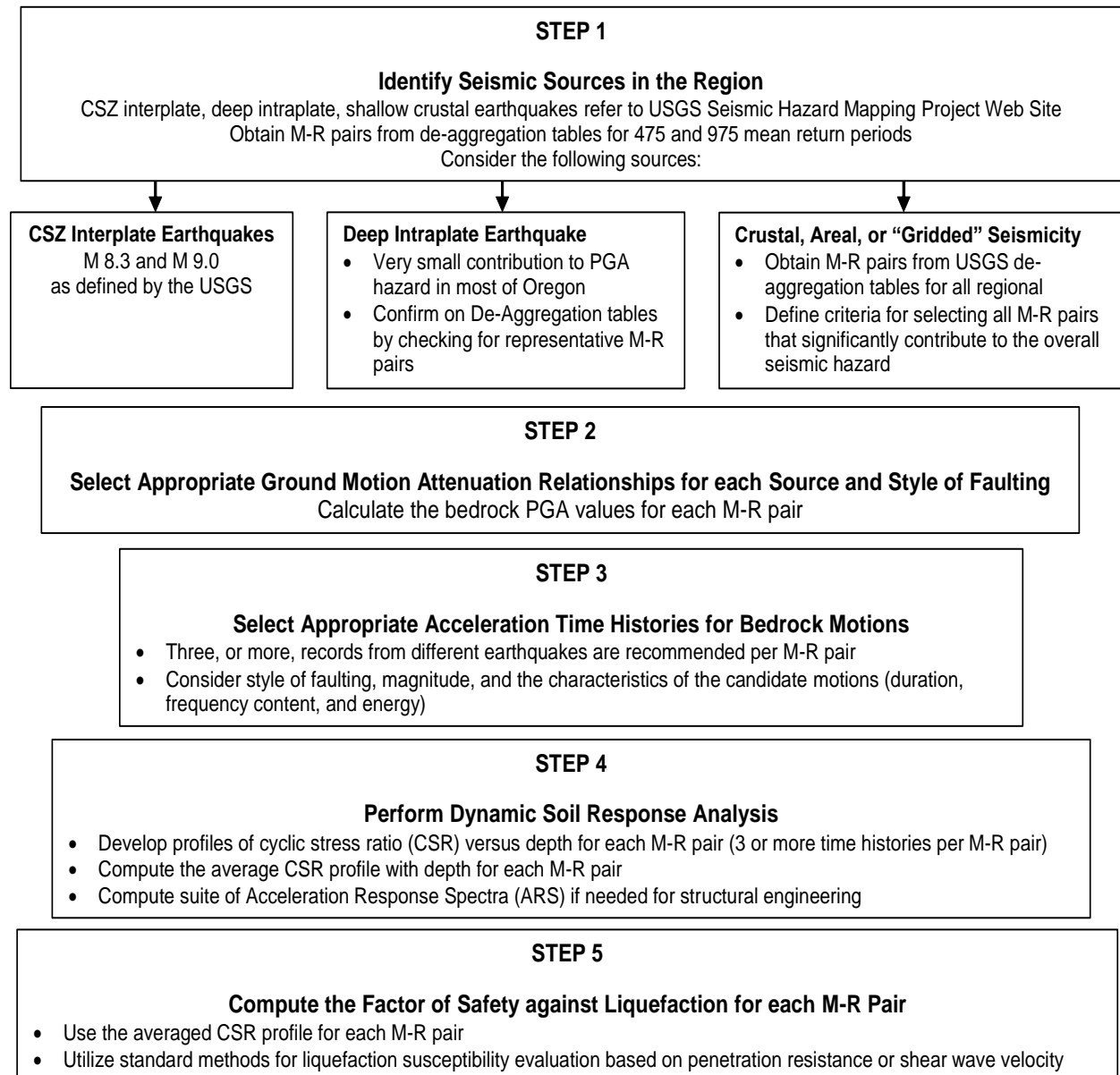

# Appendix 13-B ODOT Liquefaction Mitigation Procedures

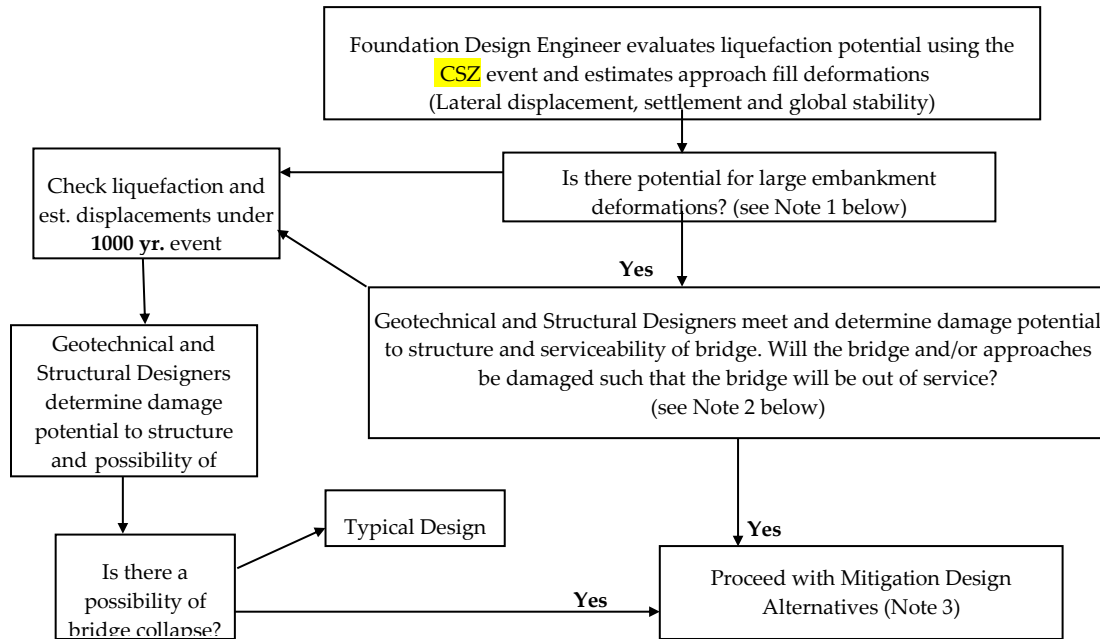

**Note 1:** For meeting the performance requirements of the CSZ event (Operational Level), lateral deformation of approach fills of up to 12" are generally considered acceptable under most circumstances pending an evaluation of this amount of lateral deformation on abutment piling. Larger lateral deformations and settlements may be acceptable under the 1000 year event as long as the "no-collapse" criteria are met.

**Note 2:** The bridge should be open to emergency vehicles after the CSZ design event, following a thorough inspection. If the estimated embankment deformations (vertical or horizontal or both) are sufficient enough to cause concerns regarding the serviceability of the bridge, mitigation is recommended.

**Note 3:** Refer to GDM [Chapter 7](#), ODOT research report SRS 500-300: "Reducing Seismic Risk to Highway Mobility: Assessment and Design Examples for Pile Foundations Affected by Lateral Spreading", December, 2012 and FHWA NHI-06-019 and 020 reports; "Ground Improvement Methods, Volume I & II" for mitigation alternatives and design procedures (Elias et al., 2006).

# Chapter 14 - Ground Improvement



## Chapter Contents

Chapter 14 - Ground Improvement .....	14-1
14.1 General.....	14-2
14.2 Design Considerations .....	14-2
14.3 Design Standards .....	14-3
14.4 References .....	14-5

## 14.1 General

Ground improvement is used to address a wide range of geotechnical engineering problems, including, but not limited to, the following:

- Improvement of soft or loose soil to reduce settlement, increase bearing resistance, and/or to improve overall stability of bridge foundations, retaining walls, and/or for embankments,
- To mitigate liquefiable soils,
- To improve slope stability for landslide mitigation,
- To retain otherwise unstable soils,
- To improve workability and usability of fill materials,
- To accelerate settlement and soil shear strength gain.

Types of ground improvement techniques include the following:

- Vibrocompaction techniques such as stone columns and vibroflotation, and other techniques that use vibratory probes that may or may not include compaction of gravel in the hole created to help densify the soil,
- Deep dynamic compaction,
- Blast densification,
- Geosynthetic **base** reinforcement for embankments **on poor foundations**,
- Wick drains, sand columns, and similar methods that improve the drainage characteristics of the subsoil and thereby help to remove excess pore water pressure that can develop when loads are applied to the soil,
- Grout injection techniques and replacement of soil with grout, such as compaction grouting, and jet grouting,
- Deep mixing methods,
- Lime or cement treatment of soils to improve their shear strength and workability characteristics,
- Permeation grouting and ground freezing (temporary applications only).

Each of these methods has its own technology, effectiveness and suitability for different soil types and also limitations regarding their applicability and the degree of potential soil improvement.

## 14.2 Design Considerations

In general, the geotechnical investigation conducted to design the cut, fill, structure foundation, retaining wall, etc., that the improved ground is intended to support will be adequate for the design of the soil improvement technique proposed. However, specific soil information may need to be emphasized depending on the ground improvement technique selected.

For example, for Vibrocompaction techniques, deep dynamic compaction, and blast densification, detailed soil gradation information is critical to the design of such methods, as minor changes in soil gradation characteristics could affect method feasibility. Furthermore, the

in-situ soil testing method used during the investigation stage (e.g., SPT testing, cone testing, etc.) needs to be the same as the method specified in the contract to verify performance of the ground improvement technique. The in-situ soil test data obtained during the site investigation will be the baseline for comparison to the test data taken in the improved ground.

Specific feasibility issues need to be addressed if these types of techniques are used. Ground vibrations caused by the improvement technique may have critical impacts on adjacent structures. Investigation of the foundation and soil conditions beneath adjacent structures and utilities may be needed, (in addition to standard precondition surveys of the structures) to enable evaluation of the risk of damage caused by the ground improvement technique.

Environmental regulations may also restrict the use of specific ground improvement methods in some areas and must be assessed. For example, the use of stone columns in environmentally sensitive areas such as wetlands may be restricted or not allowed.

At sites where contaminated soils are present, any ground improvement method considered for mitigation should not result in a potential for transfer of subsurface contamination, either horizontally or vertically, through the substrate to uncontaminated soils or groundwater. For wick drains, the ability of the wick drain mandrel to penetrate the soil to the desired design depth must be assessed. The subsurface investigation should identify very dense soil layers, cobbles, boulders or other obstructions that may restrict mandrel penetration.

Grout injection techniques (not including permeation grouting) can be used in a fairly wide range of soils, provided the equipment used to install the grout could penetrate the soil. The key is to assess the ability of the equipment to penetrate the soil, assign soil density and identify potential obstructions. Permeation grouting is more limited in its application, and its feasibility is strongly dependent on the ability of the grout to penetrate the soil matrix under pressure. To evaluate the feasibility of these two grouting techniques, detailed grain size characterization and permeability assessment must be conducted, as well as the effect groundwater may have on these techniques. An environmental assessment of such techniques may also be needed, especially if there is potential to contaminate groundwater supplies.

Similarly, ground freezing is a highly specialized technique that is **dependent** on the soil characteristics and groundwater flow rates present.

### **14.3 Design Standards**

The following design manuals and references **should be reviewed in the design development of** specific ground improvement applications:

- **General Ground Improvement Design Requirements:**

The reference manuals for the NHI Course “*Ground Modification Methods*,” (FHWA-NHI-16-027 & FHWA-NHI-16-028, Schaefer, et al., 2017) should be referenced for the design of ground improvement methods, supplemented as described below.

- **Stone Column Design:**



FHWA Report FHWA/RD-83/O26, *“Design and Construction of Stone Columns,”* (Barksdale and Bachus, 1983).

The following ODOT/OTREC research report, and the associated reference papers by Rayamajhi, et. al., (2013) and Nyguyn, et. al., (2013), provides additional information regarding the effectiveness of using stone columns to reduce shear stress in surrounding soils subjected to earthquake shaking. The assumption of strain compatibility between the stone column material and the surrounding improved soil may not be applicable and the reinforcing effect of stone columns to mitigate liquefaction effects is likely very small. Therefore, the shear stress reduction and soil reinforcement mechanism of stone columns should not be used for mitigation of liquefiable soils.

ODOT Research Report OR-RD-13-09, *“Reducing Seismic Risk to Highway Mobility: Assessment and Design of Pile Foundations Affected by Lateral Spreading”*, (Ashford, S., A., et al., 2013), Oregon State University.

- **Deep Dynamic Compaction:**

FHWA manual FHWA-SA-95-037, Geotechnical Engineering Circular No. 1, *“Dynamic Compaction,”* (Lukas, 1995)

- **Deep Mixing Methods:**

FHWA manual FHWA-HRT-13-046, *“Federal Highway Administration Design Manual: Deep Mixing for Embankment and Foundation Support”*, (Bruce, M.C., et. al., 2013). This report provides background on deep mixing for U.S. transportation projects and provides further information on design and construction aspects. This report also includes guidelines required for U.S. transportation engineers to plan, design, construct, and monitor deep mixing projects for embankment and foundation support applications. Considerations for secondary associated applications such as excavation support and liquefaction mitigation are also discussed.

- **Wick Drain Design:**

FHWA manual FHWA/RD-86/168, *“Prefabricated Vertical Drains –Volume 1, Engineering Guidelines,”* (Rixner, J.J., et al., 1986)

- **Blast Densification:**

WSDOT Research Report WA-RD 348.1, *“Blast Densification for Mitigation of Dynamic Settlement and Liquefaction,”* (Kimmerling, R. E., 1994).

Proceedings of the 10th International Conference on Soil Mechanics and Foundation Engineering, *“Soil Improvement: State-of-the-Art Report”*, (Mitchell, J. K., 1981), Stockholm, Sweden, pp. 509-565.

- **Lime and Cement Soil Treatment:**

Alaska DOT/FHWA Report FHWA-AK-RD-01-6B, *“Alaska Soil Stabilization Design Guide”*, (Hicks, R.G., 2002).

## 14.4 References

- Ashford, S. A., Scott, M. H. and Rayamajhi, D., 2013, *Reducing Seismic Risk to Highway Mobility: Assessment and Design of Pile Foundations Affected by Lateral Spreading*, ODOT Research Report OR-RD-13-09, Oregon Department of Transportation.
- Barksdale, R. D., and Bachus, R. C., 1983, *Design and Construction of Stone Columns – Vols. 1 and 2*, Federal Highway Administration, FHWA/RD-83/026 and FHWA/RD-83/027.
- Bruce, M.C., Berg, R.R., Collin, J.G., Filz, G.M., Terashi, M., Yang, D. S., 2013, *Federal Highway Administration Design Manual: Deep Mixing for Embankment and Foundation Support*, FHWA-HRT-13-046, US Dept. of Transportation, Federal Highway Administration.
- Hicks, R. G., 2002, *Alaska Soil Stabilization Design Guide*, Alaska Department of Transportation and Federal Highway Administration Report No. FHWA-AK-RD-01-6B.
- Kimmerling, R. E., 1994, [Blast Densification for Mitigation of Dynamic Settlement and Liquefaction](#), WSDOT Research Report WA-RD 348.1, 114 pp.
- Lukas, R. G., 1995, [Geotechnical Engineering Circular No 1 - Dynamic Compaction](#), Federal Highway Administration, FHWA-SA-95-037.
- Mitchell, J. K., 1981, *Soil Improvement: State-of-the-Art Report*, Proceedings of the 10th International Conference on Soil Mechanics and Foundation Engineering, Stockholm, Sweden, pp. 509-565.
- Nguyen, T. V., Rayamajhi, D., Boulanger, R. W., Ashford, S. A., Lu, J., Elgamal, A., and Shao, L., 2013, *Design of DSM Grids for Liquefaction Remediation*, ASCE [Journal of Geotechnical and Geo-environmental Engineering](#), Nov 2013, Vol. 139, No. 11, pp. 1923-1933.
- Rayamajhi, D., Nguyen, T. V., Ashford, S. A., Boulanger, R. W., Lu, J., Elgamal, A and Shao, L., *Numerical Study of Shear Stress Distribution for Discrete Columns in Liquefiable Soils*, [ASCE Journal of Geotechnical and Geo-environmental Engineering](#), Online Publication Date: 27 May 2013.
- Rixner, J. J., Kraemer, S. R., and Smith, A. D., 1986, [Prefabricated Vertical Drains - Vol. 1: Engineering Guidelines](#), FHWA/RD-86/168, Federal Highway Administration, FHWA.
- Schaefer, V.R., Berg, R.R., Collin, J.G., Christopher, B.R., DiMaggio, J.A., Filz, G.M., Bruce, D.A., and Ayala, D., 2017. *Ground Modification Methods, Volumes I and II*, FHWA NHI-16-027 and FHWA NHI-16-028, US Dept. of Transportation, Federal Highway Administration.

# Chapter 15 - Geosynthetic Design



## Chapter Contents

<b>Chapter 15 - Geosynthetic Design .....</b>	<b>15-1</b>
15.1 Introduction .....	15-3
15.1.1 Geosynthetic Products .....	15-3
15.1.2 Materials In Manufacture Of Geosynthetics .....	15-3
15.1.3 Geosynthetic Functions .....	15-3
15.1.4 Geosynthetic Material Selection And Specification .....	15-4
15.2 Geosynthetic Types, Characteristics And Highway Applications.....	15-5
15.2.1 Geotextiles .....	15-5
15.2.2 Geogrids .....	15-6
15.2.3 Geocomposite .....	15-6
15.2.4 Geomembrane.....	15-7
15.2.5 Geocell.....	15-7
15.3 Geosynthetic Functional And Application Design .....	15-7
15.3.1 Drainage Geotextile - Subsurface Drainage Filter Design.....	15-13
15.3.2 Riprap Geotextile.....	15-13
15.3.3 Sediment Fence.....	15-13
15.3.4 Subgrade Geotextile (Separation) .....	15-14
15.3.5 Embankment Geotextile .....	15-14
15.3.6 Pavement Overlay Geotextile.....	15-15
15.3.7 Subsurface Drainage Design.....	15-15
15.4 References .....	15-15

**List Of Tables**

---

Table 15-1 Geosynthetic and Associated Functions ..... 15-9  
Table 15-2 Geosynthetic Applications and Functional Properties for Evaluation (Modified from  
FHWA-NHI-07-092)..... 15-9  
Table 15-3 Guidelines for Evaluating Critical Nature or Severity of Drainage and Erosion  
Control Applications..... 15-11

**List Of Figures**

---

Figure 15-1 FHWA Filter Design Procedure Flow Chart ..... 15-12

## 15.1 Introduction

This chapter provides an overview of geosynthetic types, materials, functions, and design for use in highway construction projects. Although geosynthetic materials have been used in highway construction for decades, design standards continue to evolve for existing and new applications. Geosynthetic technology continues to improve materials and their performance while research continues to improve design methods through the use of index properties.

### 15.1.1 Geosynthetic Products

Geosynthetic is defined in ASTM D4439 - Standard Terminology for Geosynthetics as a planar product manufactured from polymeric material used with soil, rock, earth, or other geotechnical engineering related material as an integral part of a man-made project, structure, or system.

Geosynthetic product types discussed in this chapter are listed below. See also ASTM D4439 Standard Terminology for Geosynthetics for additional definitions.

- Geotextile - a permeable geosynthetic comprised solely of textiles.
- Geogrid - a geosynthetic formed by a regular network of integrally connected elements with apertures greater than 6.35 mm (1/4 in.) to allow interlocking with surrounding soil, rock, earth, and other surrounding materials to function primarily as reinforcement.
- Geostrip - polymeric material in the form of a strip of width not more than 8 in., used in contact with soil or other materials.
- Geocomposite - a product composed of two or more materials, at least one of which is a geosynthetic.
- Geomembrane - an essentially impermeable geosynthetic composed of one or more synthetic sheets.
- Geocell - a three-dimensional comb-like structure, filled with soil, aggregate or concrete.
- Geonet - a geosynthetic consisting of integrally connected parallel sets of ribs overlying similar sets at various angles for planar drainage of liquids or gases.

### 15.1.2 Materials In Manufacture Of Geosynthetics

Geosynthetics are manufactured from synthetic polymers (for example polyethylenes, polypropylenes, polyester, etc.). A primary polymer resin may be combined with other resins, fillers and additives (for example UV absorbers, stabilizers, plasticisers, fibers, etc.) The formulation of polymers and additives, methods of manufacture, fiber type, fabric structure, and coating (if used) provides variability of geosynthetic product types, material properties, and performance properties, necessary to engineer solutions for construction applications.

### 15.1.3 Geosynthetic Functions

Geosynthetic functions presented in this chapter include:

- Filtration – To provide adequate water flow and limit soil clogging and migration through the Geosynthetic.
- Drainage – To provide capacity and conveyance for water flow through or along the plane of the geosynthetic. In typical geocomposite drains the flow is along the plane of the geosynthetic material combination.
- Separation – To provide isolation, maintain integrity and prevent intermixing between subsurface layers: preventing base aggregate from penetrating into soft subgrade, preventing pumping of fine grained soils into base aggregate.
- Reinforcement – To add tensile element to a soil or soil mass, creating a soil mass and geosynthetic reinforcement matrix which improves strength and stability. Examples for uses of reinforcement include MSE walls, reinforced soil slopes, subgrade stabilization and base/subbase courses of pavement structures.
- Fluid barrier -To impede the flow of a liquid or gas across the plane of the geosynthetic. Examples of fluid barriers include controlling moisture seepage into subgrade, stormwater ponds, prefabricated vertical drains, and bridge decks.
- Protection - Providing a layer to minimize damage: geosynthetic mat for erosion control, stress relief: addition of geotextile as puncture protection for geomembrane, geomembrane placement for protection of metallic reinforcements from infiltration of de-icing salts runoff into MSE backfill

### 15.1.4 Geosynthetic Material Selection And Specification

ASTM Committee D35 on Geosynthetics formulates test methods, specifications, guides, practices, and terminology regarding Geosynthetics materials testing. AASHTO Committee on Materials and Pavement (COMP), Technical Subcommittee 4e (TS4e) develops standards and guides, material specifications for bearings, joints and geosynthetics. TS4e has developed AASHTO M 288 Standard Specification for Geosynthetic Specification for Highway Applications. This specification is a materials specification for geosynthetics used in subsurface drainage, separation, stabilization, erosion control, temporary silt fence, paving, and soil (walls and slopes). The testing methods and criteria are organized by function with reference to ASTM test methods. The materials tables in ODOT Specifications 02320 Geosynthetics are produced from AASHTO M 288. National Transportation Product Evaluation Program (NTPEP) is a technical service program of AASHTO, resourced by State DOTs, AASHTO and contracted product materials testing and manufacturing auditors to evaluate materials, products, and devices of common interest for use in highway and bridge construction with a goal of eliminating duplication of testing and auditing by the states and duplication of effort by the manufacturers that provide products for evaluation. Technical committees within NTPEP serve as liaison to AASHTO COMP. The NTPEP Geosynthetics technical committee has two product evaluation plans, but is expected to continue expansion to include more applications of Geosynthetics. The geosynthetic product material evaluation plans are as follows:

- Geotextiles (GTX)

This includes geotextiles used in subsurface drainage, erosion control, temporary silt fence and paving.

- Reinforcement Geosynthetics (REGEO)

This includes geosynthetic reinforcement for reinforced soil walls, reinforced slopes, and reinforced fills over soft ground.

Annual independent sampling, testing and auditing of these products under NTPEP program provide data for states to evaluate geosynthetics included in the program.

Common separation, filtration, drainage, erosion control, reinforcement geosynthetics applications often refer to Standard Specifications for Geosynthetic properties. ODOT Standard Specifications with geosynthetic application include:

- Section 00280 Erosion and Sediment Control
- Section 00331 Subgrade Stabilization
- Section 00350 Geosynthetic Installation
- Section 00390 Riprap Protection
- Section 00435 Prefabricated Vertical Drains
- Section 00596A Mechanically Stabilized Earth Retaining Walls
- Section 00596B Prefabricated Modular Retaining Walls
- Section 00596C Cast-in-Place Concrete Retaining Walls
- Section 00748 Asphalt Concrete Pavement Repair
- Section 02320 Geosynthetics

There are Geosynthetics applications in highway construction not covered by ODOT, ASTM or AASHTO specifications. Geocells and composite wall drains are examples of common products without established ASTM or AASHTO standards. In some cases manufacturers have developed a specification for an innovative product. In the absence of developed standards, use diligence to ensure the design and specification are adequately substantiated by laboratory and field data, and cannot be substituted with existing established materials and standards of practice.

## **15.2 Geosynthetic Types, Characteristics And Highway Applications**

### **15.2.1 Geotextiles**

Geotextiles are made from one or more synthetic polymers. The most common: polypropylene (PP), polyester (PET), and polyethylene (PE), all generally have good resistance to common biological and chemical degradation. The seaming thread used for sewn geotextiles should be material of equal or greater durability as the fabric. Nylon (polyamide (PA)) is not durable in soil so nylon thread should not be used. Geotextiles require protection from ultra violet (UV)

light degradation. This is achieved by limiting UV exposure time, addition of stabilizing additives to the formula, and use of protective wrapping of the product rolls for shipping. ODOT Standard Specifications for Construction Section 02320 Geosynthetics include geotextile property requirements by ASTM D4355.

The polymers used in the manufacture of geotextiles are formed into one of the three basic fiber types: filaments (long polymer yarns), staple fibers (cut polymer yarns), and slit films (yarns cut from polymer sheet). Specification Section 02320 does not allow slit film geotextiles for use in Drainage Geotextile or Riprap Geotextile. Geotextile fabric types are woven or nonwoven. Woven geotextiles are made by weaving yarns. Nonwoven geotextiles are made with polymer yarns that are massed together and needlepunched (mechanically bonded), wet laid resin bonded (chemical bonded), or spunbonded (heat bonded). The long-term performance of a geotextile is a function of the durability and creep characteristics of the polymer structure and fabric style.

Geotextiles are available in a variety of geometric and polymeric composition to serve various applications. Geotextiles are used for separation, reinforcement, filtration, drainage, and hydraulic barrier.

Woven geotextiles exhibit high tensile strength, high modulus, and low strain. Woven geotextiles are commonly used for reinforcement.

Non-woven geotextiles typically have high permeability and high strain characteristics. Thermal treatment can add strength. Non-woven geotextiles are commonly used for filtration, drainage, separation and protection,

## **15.2.2 Geogrids**

Geogrids are fabricated several ways: from extrusion of perforated polymer sheets that are stretched in one or more directions under controlled temperature to form the desired size and proportion of grid openings; from weaving: yarns are woven and coated to form polymer grid sheets; another manufacture process involves bonding or welding polymer strips. Geogrids as well as coating materials for geogrids are made from one or more polymers.

The chief qualities of geogrids are their high tensile strength with low deformation and ample apertures between tensile elements to interlock with surrounding compacted aggregates. The principal strength orientation can be one direction (machine direction, uniaxial), two directions (machine and cross-machine direction, biaxial), and triaxial (proprietary product). Therefore, their primary function is in reinforcement applications such as MSE walls, reinforced steepened slopes, and subgrade stabilization.

## **15.2.3 Geocomposite**

Geocomposites are made from two or more geosynthetics. Geosynthetic combinations include geotextile-geonets, geotextile-geogrids, geotextile-geomembranes, geomembrane-geonets, geotextile-polymeric cores, and three-dimensional polymeric cell structures. Drainage geocomposites are presented in this manual. Prefabricated vertical drains, also known as PVDs



or wick drains are constructed of a stiff plastic core, surfaced to promote drainage and jacketed in a nonwoven geotextile. The PVD is pushed into place in a grid pattern in soft, compressible soils to remove excess pore pressure and increase the rate of consolidation. Wick drain design considerations, example designs, guideline specifications, and installation considerations are provided by reference in [Chapter 12](#). Section 00435 of the ODOT Standard Specifications addresses installation of wick drains.

Prefabricated wall drains have a drainage core (dimpled or fluted plastic sheets, geonets, or other) sandwiched with filtration and separation geotextile facing. They are commonly used behind the facing of soil nail and soldier pile retaining walls to drain the retained soil. The geotextile facing wrap keeps the core clean of fines so water can flow through the drainage core.

## 15.2.4 Geomembrane

Three main manufacturing methods of geomembrane are by extrusion, calendaring (rolled through a series of high pressure rollers), and spread coating. Each of these start with the polymer resin and various additives that make up the formulation to be processed into the geomembrane sheet. Some geomembranes are processed creating a roughened surface, some are multiple plies and may include a layer of geotextile or bituminous permeated geotextile. Geomembrane use covers a wide range of applications: as fluid barriers and liners to prevent leakage and inhibit infiltration of fluid as well as protection from contaminants in the fluid; they are also used for containment. Geomembranes are used for waterproofing tunnels and other structures, for controlling moisture infiltration into a subgrade of expansive soil, for lining stormwater detention ponds, for protection steel reinforced MSE wall backfill from infiltration of deicing salts, for lining polystyrene geofoam lightweight embankment fill as protection from petrochemical spills that destabilize and dissolve the material, etc.

## 15.2.5 Geocell

Geocells are commonly made from high and low density polyethylene (HDPE, LLDPE) panels that expand to form three-dimensional cellular structures. Interconnected, expanded panels provide confinement and reinforcement for infill material. Geocells have been used as plantable facing on reinforced steepened embankment slopes adjacent to wetlands, and as base support on weak subgrade. Standards are presently lacking for Geocells, however ASTM D35 Geosynthetics Committee work item ATSM WK61159 is scoped to develop guidance on design principles, properties and methods for geocells in slope stability, erosion control, retaining walls, channel protection, pavement load support, and subgrade improvement.

# 15.3 Geosynthetic Functional And Application Design

Geosynthetic properties needed for design depend on their function and application. (Primary functions repeated from 14.1.3: filtration, drainage, separation, reinforcement, fluid barrier, and

protection). With each type of application of geosynthetics (for example: inlet protection, reinforcement beneath asphalt overlay, subsurface drainage filter, subgrade stabilization, etc.), a primary function as well as secondary function(s) distinguish the criteria and properties important for design, construction and longevity. ASTM test methods and material properties listed for geotextiles and geogrids by function and application (Drainage Geotextile, Riprap Geotextile, Sediment Fence, Subgrade Geotextile – Separation, and Pavement Overlay Geotextile) in ODOT Standard Specifications Section 02320 – Geosynthetics. In most situations where a geosynthetic is specified for these applications, the material from the Standard Specifications can be used.

Design and applications of Geosynthetics are also discussed in other chapters of this manual and in other ODOT manuals:

- GDM [Chapter 15](#)- Retaining Walls for Mechanically stabilized earth walls and reinforced slopes.
- GDM [Chapter 9](#)- Embankments for embankment base reinforcement.
- GDM [Chapter 9](#)- Embankments as well as GDM [Chapter 12](#) for wick drains.
- ODOT Erosion Control Manual for erosion and sediment control Geosynthetic applications.
- ODOT Pavement Design Guide for subgrade stabilization and Geosynthetics in roadbed prism functions

[Table 15-1](#) lists types of geosynthetics along with functions. [Table 15-2](#) provides specific applications and the associated primary and secondary functions.

**Table 15-1 Geosynthetic and Associated Functions**

Type of Geosynthetic	Function					
	Filtration	Drainage	Separation	Reinforcement	Fluid Barrier	Protection
Geotextile	√	√	√	√		√
Geogrid				√		
Geonet		√				
Geomembrane					√	√
Geosynthetic Clay Liner					√	√
Geocomposite	√	√	√	√	√	√
Geocell						√

**Table 15-2 Geosynthetic Applications and Functional Properties for Evaluation (Modified from FHWA-NHI-07-092)**

PRIMARY FUNCTION	APPLICATION EXAMPLES	SECONDARY FUNCTION(S)
Filtration	1. Trench drain and base drain lining	1. Separation, drainage
	2. Perforated pipe and subsurface drain wrapping	2. Separation, drainage, protection
	3. Silt fence	3. Separation, drainage
	4. MSE facing panel joint cover	4. Drainage
	5. Filter layer between backfill and gabion wall or other modular walls	5. Separation, drainage
	6. Welded wire wall facing filter	6. Separation, drainage
Drainage	1. Prefabricated vertical drains (PVD, wick drains)	1. Separation, filtration
	2. Geocomposite wall drains	2. Filtration

PRIMARY FUNCTION	APPLICATION EXAMPLES	SECONDARY FUNCTION(S)
Separation	1. Subgrade separation	1. Filtration, drainage
	2. Subgrade stabilization	2. Filtration, reinforcement
	3. Temporary construction access	3. Filtration, drainage, reinforcement
Reinforcement	1. MSE retaining walls, reinforced slopes	1. Drainage
	2. Subbase reinforcement, load distribution pad	2. Separation
	3. Embankment over soft subgrade	3. Filtration, drainage, separation
Fluid barrier	1. Ditch liner	1. ---
	2. Stormwater pond lining	2. ---
	3. Structure waterproofing	3. ---
	4. Control of moisture infiltration into expansive soil or from wet soils	4. ---
Protection	1. As Cushion for geomembrane puncture protection	1. ---
	2. Protection of MSE backfill from road deicing salts	2. Fluid barrier
	3. Protection of geofoam fill from effect of petrochemicals	3. Fluid barrier

Design approach from Holtz et. al. 2008:

1. Define the purpose and establish the scope of the project.
2. Investigate and establish the geotechnical conditions at the site (geology, subsurface exploration, laboratory and field testing, etc.).
3. Establish application criticality, severity, and performance criteria. Determine external factors that may influence the geosynthetic's performance. Critical projects with severe conditions or consequences warrant thorough engineering.
4. Formulate trial designs and compare several alternatives.
5. Establish the models to be analyzed, determine the parameters, and carry out the analysis.
6. Compare results and select the most appropriate design; consider alternatives versus cost, construction feasibility, etc. Modify the design if necessary.
7. Prepare detailed plans and specifications including: a) specific property requirements for the geosynthetic; and b) detailed installation procedures.

8. Hold preconstruction meeting with contractor and inspectors.
9. Approve geosynthetic on the basis of specimens' laboratory test results and/or manufacturer's certification.
10. Monitor construction.
11. Inspect after major events (e.g., 100 year rainfall or an earthquake) that may compromise system performance

**Table 15-3 Guidelines for Evaluating Critical Nature or Severity of Drainage and Erosion Control Applications**

<b>A. Critical Nature of Project</b>		
<u>Item</u>	<u>Critical</u>	<u>Less Critical</u>
1. Risk of loss of life and/or structural damage due to drain failure:	High	None
2. Repair costs versus installation costs of drain:	Significantly greater	Less than or equal
3. Evidence of drain clogging before potential catastrophic failure:	None	Yes
<b>B. Severity of the Conditions</b>		
<u>Item</u>	<u>Severe</u>	<u>Less Severe</u>
1. Soil to be drained:	Gap-graded, pipable or dispersible	Well-graded or uniform
2. Hydraulic gradient:	High	Low
3. Flow conditions:	Dynamic, cyclic, or Pulsating	Steady state

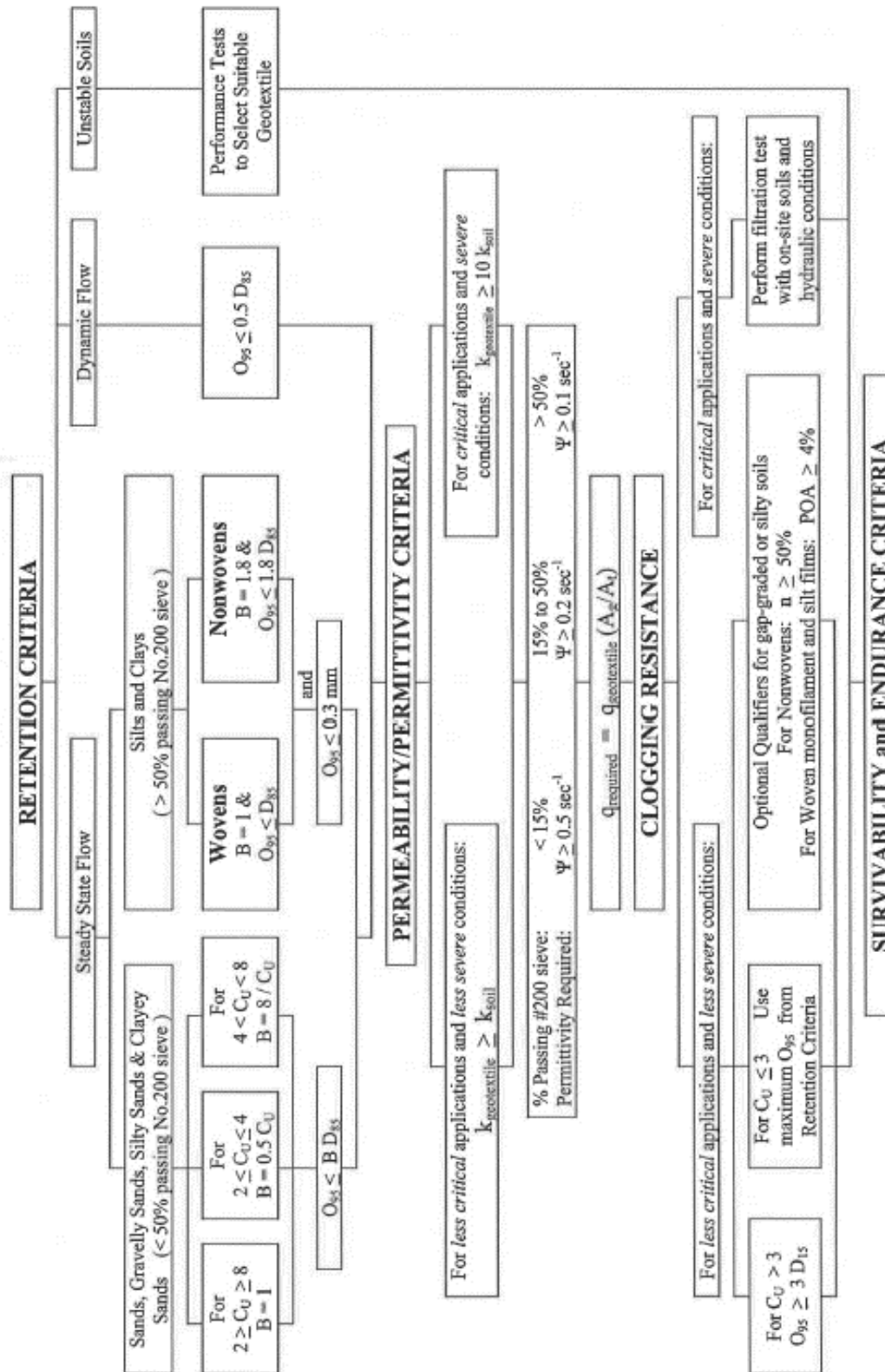

Figure 15-1 FHWA Filter Design Procedure Flow Chart

### 15.3.1 Drainage Geotextile - Subsurface Drainage Filter Design

Drainage and filter geotextiles often are misnamed and/or misidentified. Even in the ODOT Standard Specifications Section 00350, the definition of drainage geotextile is defined as a filter. With that in mind, drainage geotextile is often referred to as filter fabric for the purposes of this manual, the definitions, and recommended primary function of the geotextile. Geotextiles used for wrapping subsurface drain aggregate have the primary function of filtration and secondary functions separation, drainage, and protection. Geotextile filtration design procedure is given in Holtz et. al. 2008. The flow chart is shown above in [Figure 15-1](#). Filtration geotextiles are most commonly nonwoven. As with graded granular filter design criteria, a geotextile filter also needs to satisfy criteria for retention, permeability, and resist clogging. Standard Specification 02320 for Drainage Geotextile lists geotextile strength requirements for installation and survivability, apparent opening size, permittivity and UV stability for Type 1 and Type 2 Drainage Geotextile. Distinct minimum property values are given for woven and nonwoven type 1 (lower strength) and type 2 (higher strength) drainage geotextiles. Type 1 Drainage Geotextile is used in applications with low contact stress subsurface drainage applications: rounded drainage aggregate, low confining stress, low compaction stress. Type 1 Drainage Geotextile is specified for use in Section 00596A, 00596B, and 00596C (geotextile filter for subsurface drainage, concrete panel facing joint cover, modular block drainage fill filter, welded wire facing filter, filter between backfill and gabion wall). Type 2 Drainage Geotextile is used in high contact stress subsurface drainage applications such as: angular drainage aggregate, heavy compaction, high confining stress. Standard Specification 00350 should be used for installation, placement and construction.

### 15.3.2 Riprap Geotextile

Riprap geotextiles function as separation, filtration and protection/erosion control of the slope beneath riprap. Standard Specification 02320 for Riprap Geotextile lists geotextile strength requirements for installation and survivability, apparent opening size, permittivity and UV stability for Type 1 and Type 2 Riprap Geotextile. Distinct minimum property values are given for woven and nonwoven type 1 (lower strength) and type 2 (higher strength) riprap geotextiles. Standard Specification 00350 Geosynthetic Installation addresses the placement and construction requirements. Design Guidelines and examples of geotextiles in permanent erosion control systems as well as installation procedures for specific applications and alternate riprap designs are provided in Holtz et. al 2008.

### 15.3.3 Sediment Fence

Geotextiles used for sediment fence have the primary function of filtration and secondary functions separation, drainage, and protection. Design of sediment fence is presented in the ODOT Erosion Control Manual. Standard Specification 02320 for Sediment Fence lists geotextile strength requirements for installation and survivability, apparent opening size, permittivity and

UV stability for geotextile used in sediment fence. Section 00350 Geosynthetic Installation addresses the placement and construction requirements.

### **15.3.4 Subgrade Geotextile (Separation)**

In subgrade separation, the geosynthetic is placed at the interface between subgrade and aggregate (or in general between dissimilar materials) to prevent intermixing of either material upward or downward. By protecting against fines migrating upwards, a secondary function is filtration. There is also drainage to some extent. Separation geotextile can be either woven or nonwoven – generally a woven is stiffer (<50% strain) so it has less elongation but requires a smooth surface for good contact, while a nonwoven is more flexible (>50% strain) and will conform better to surface irregularities, nonwovens also provide better drainage properties. Standard Specification 02320 for Subgrade Geotextile (Separation) lists geotextile strength requirements for installation and survivability, apparent opening size, permittivity and UV stability.

### **15.3.5 Embankment Geotextile**

Embankment geotextile is used as separation and reinforcement in the lower portion of embankment to strengthen the foundation and in layered embankment construction.

Embankment geotextile can be either woven or nonwoven. Standard Specification 02320 for Embankment Geotextile lists geotextile strength requirements for installation and survivability, apparent opening size, permittivity and UV stability. Section 00350 Geosynthetic Installation addresses the placement and construction requirements.

Failure mechanisms for reinforced embankments on soft foundations include:

- Bearing failure
- Rotational failure (shear slip surface)
- Lateral spreading (sliding wedge)

Layers of embankment geotextile or geogrid can be designed to reinforce Design steps for reinforced embankments on soft foundations condensed from FHWA NHI-07-092 Geosynthetic Engineering, Chapter 8 Reinforced Embankments:

1. Establish embankment dimensions and loading.
2. Determine engineering properties and soil profile of the foundation.
3. Determine engineering properties of the embankment.
4. Evaluate bearing resistance.
5. Perform rotational stability analysis without base reinforcement; establish limits of failure zone.
6. Perform lateral spreading stability analysis
7. Establish tolerable geosynthetic deformation, required reinforcement modulus, tensile strength, soil-reinforcement friction, anchorage length beyond failure zone to resist pullout. Check transverse direction and longitudinal direction.
8. Estimate anticipated settlement, anticipated rate of settlement



9. Specify subgrade preparation, geosynthetic and fill placement sequence and compaction, and construction monitoring recommendations

See GDM [Chapter 15](#) and FHWA manual “Mechanically Stabilized Earth Walls and Reinforced Soil Slopes Design & Construction Guidelines” by Berg, et al for design of reinforced soil slopes.

### 15.3.6 Pavement Overlay Geotextile

Pavement overlay geotextile provides reinforcement, stress relief and separation beneath asphalt concrete overlay. See ODOT Pavement Design Manual for geosynthetic placement subgrade and pavement structure. Specification 02320 for Pavement Overlay Geotextile lists geotextile strength and strain requirements, asphalt retention and melting point minimum property values. Section 00350 Geosynthetic Installation addresses the placement and construction requirements.

### 15.3.7 Subsurface Drainage Design

In most drainage applications involving geosynthetics, the geosynthetic’s primary role is filtration, for example geotextile wrap encasing drainage aggregate (discussed above). Geosynthetics for the primary function as drainage applications (flow along the plane of geosynthetic) include composite prefabricated vertical drains (see [Chapter 12](#)), horizontal drains with geotextile wrap (see [Chapter 10](#)), nonwoven needlepunched geotextile drainage blanket over steep slopes in seepage areas (see [Chapter 10](#)), composite prefabricated wall drains behind soldier pile, soil nail retaining walls (see [Chapter 15](#)).

Drainage design steps and a trench drain design example as well as prefabricated geocomposite drain design example are provided in Holtz et. al. 2008.

## 15.4 References

AASHTO, 2017, *Standard Specification for Geotextile Specification for Highway Applications - Geotextile Specification for Highway Applications, Designation M 288-17*, American Association of State Highway and Transportation Officials, Washington, D.C., USA.

AASHTO, 2015, *Standard Practice of Long-Term Strength for Geosynthetic Reinforcement*, Designation R69-15, American Association of State Transportation and Highway Officials, Washington, D.C., USA.

AASHTO, 2018, *Recommended Practice for Geosynthetic Reinforcement of the Aggregate Base Course of Flexible Pavement Structures*, R50-09, American Association of State Transportation and Highway Officials, Washington, D.C., USA.

ASTM International Standards, [www.astm.org](http://www.astm.org)

D4533, Standard Test Method for Index Trapezoid Tearing Strength of Geotextiles

D4595, Standard Test Method for Tensile Properties of Geotextiles by the Wide Width Strip Method

D4632, Standard Test Method for Grab Breaking Load and Elongation of Geotextiles

D4716, Standard Test Method for Constant Head Hydraulic Transmissivity (In-Plane Flow) of Geotextiles and Geotextile Related Products

D4751, Standard Test Method for Determining Apparent Opening Size of a Geotextile

D5141, Standard Test Method to Determine Filtering Efficiency and Flow Rate of a Geotextile for Silt Fence Application Using Site Specific Soil

D5199, Standard Test Method for Measuring the Nominal Thickness of Geosynthetics

D5262, Standard Test Method for Evaluating the Unconfined Tension Creep and Creep Rupture Behavior of Geosynthetics

D5321, Standard Practice for Immersion Procedures for Evaluating the Chemical Resistance of Geosynthetics to Liquids

D5818, Standard Practice for Exposure and Retrieval of Samples to Evaluate Installation Damage of Geosynthetics

D6637, Standard Test Method for Determining Tensile Properties of Geogrids by the Single or Multi-Rib Tensile Method

Elias, V., Welsh, J., Warren, J., Lukas, R., Collin, J.G., and Berg, R.R., *Ground Improvement Methods, Volumes I and II*, US Dept. of Transportation, Federal Highway Administration, FHWA NHI-06-019 and FHWA NHI-06-020, 2006.

Holtz, R.D., Christopher, B.R., and Berg, R.R., *Geosynthetic Design and Construction Guidelines, Participant's Notebook*, U.S. Department of Transportation, Federal Highway Administration (FHWA), FHWA NHI-07-092, August 2008.

Holtz, R.D., Christopher, B.R., and Berg, R.R., [\*Geosynthetic Design and Construction Guidelines, Participant's Notebook\*](#), U.S. Department of Transportation, Federal Highway Administration (FHWA), FHWA NHI-95-038, April 1998.

IFAI, Industrial Fabrics Association International, *Geosynthetics Magazine Specifier's Guide*, <https://geosyntheticsmagazine.com/specifiers-guide-info/>

IGS, International Geosynthetics Society, *Guide to the Specification of Geosynthetics 2018*, [www.geosyntheticsociety.org](http://www.geosyntheticsociety.org)

Koerner, R.M., *Designing with Geosynthetics*, 6th Edition, Volumes 1 & 2, Xlibris.com, Rev. 08/2016.

ODOT, [\*Bridge Design Manual \(BDM\)\*](#), Current Edition, Oregon Department of Transportation, Salem, Oregon.

ODOT, [\*Hydraulics Manual, Current Edition\*](#), Oregon Department of Transportation, Salem, Oregon.

ODOT, *Highway Design Manual*, Current Edition, Oregon Department of Transportation, Salem, Oregon.

ODOT, *Oregon Standard Specifications for Construction*

ODOT, *Pavement Design Guide*

Rixner, J.J., Kraemer, S.R., and Smith, A.D., 1986, [\*Prefabricated Vertical Drains, Volume 1, Engineering Guidelines\*](#), FHWA/RD-86/168.

Cedergren, H.R., 1989, *Seepage, Drainage, and Flow Nets*, 3rd edition.

# Chapter 16 - Retaining Structures



## Chapter Contents

<b>Chapter 16 - Retaining Structures .....</b>	<b>16-1</b>
16.1 Introduction .....	16-6
16.2 Retaining Wall Practices and Procedures .....	16-6
16.2.1 Retaining Wall Categories and Definitions .....	16-6
16.2.2 General Steps in a Retaining Wall Project.....	16-12
16.2.3 Retaining Wall Project Schedule .....	16-13
16.2.4 Selection of Retaining Wall System Type .....	16-15
16.2.5 Proprietary Retaining Wall Systems.....	16-18
16.2.6 Nonproprietary Retaining Wall Systems.....	16-19
16.2.7 Unique Nonproprietary Wall Designs .....	16-19
16.2.8 Details of Contract Documents .....	16-19
<b>16.3 Design Requirements: General Wall Design.....</b>	<b>16-26</b>
16.3.1 Design Methods.....	16-26
16.3.2 Wall Facing Considerations .....	16-27
16.3.3 Wall Face Angle (Batter).....	16-27
16.3.4 Horizontal Wall Alignment .....	16-28
16.3.5 Tiered or Superimposed Walls.....	16-29
16.3.6 Back-to-Back Walls.....	16-29
16.3.7 Wall Bench.....	16-29
16.3.8 Wall Back Slope .....	16-30
16.3.9 Wall Stability.....	16-30

16.3.10 Lateral Earth Pressures.....	16-30
16.3.11 Compaction Loads .....	16-32
16.3.12 Construction Surcharge Loads .....	16-34
16.3.13 Seismic Design.....	16-34
16.3.14 Minimum Footing Embedment.....	16-34
16.3.15 Foundation Settlement Serviceability Criteria .....	16-35
16.3.16 Groundwater Monitoring .....	16-37
16.3.17 Seismic Hazards .....	16-37
16.3.18 Wall Subsurface Drainage.....	16-37
16.3.19 Underground Utilities .....	16-39
16.3.20 Design Life .....	16-39
16.3.21 Corrosion Protection.....	16-39
16.3.22 Railing.....	16-40
16.3.23 Proprietary Minor Retaining Wall Systems.....	16-41
16.3.24 Nonproprietary Minor Retaining Wall Systems.....	16-41
16.3.25 Wall Backfill Testing and Design Properties.....	16-42
16.3.26 Temporary Shoring and Cut Slopes .....	16-43
16.3.27 Temporary Retaining Walls.....	16-47
16.4 CIP Concrete Rigid Gravity Walls.....	16-50
16.4.1 General Considerations.....	16-50
16.4.2 Geotechnical Investigation.....	16-50
16.4.3 Wall Selection Criteria.....	16-50
16.4.4 Wall Height, Footprint and Construction Easement.....	16-50
16.4.5 Design Requirements.....	16-51
16.4.6 Concrete Gravity Retaining Walls .....	16-51
16.5 CIP Concrete Semi-Gravity Cantilever Walls .....	16-52
16.5.1 General Considerations .....	16-52
16.5.2 Geotechnical Investigation.....	16-52
16.5.3 Wall Selection Criteria.....	16-52
16.5.4 Wall Height, Footprint, and Construction Easement.....	16-52
16.5.5 Design Requirements.....	16-52
16.6 Mechanically Stabilized Earth (MSE) Walls and reinforced slopes .....	16-54
16.6.1 General Considerations.....	16-55
16.6.2 Geotechnical Investigation.....	16-55
16.6.3 Wall Selection Criteria.....	16-55
16.6.4 Wall Height, Footprint, and Construction Easement.....	16-56
16.6.5 Minimum Wall Embedment.....	16-56
16.6.6 Soil Failure - External and Overall Stability Analysis.....	16-56
16.6.7 Internal Stability Analysis.....	16-58
16.6.8 Wall Drainage .....	16-60
16.6.9 Traffic Railing .....	16-60
16.6.10 Corrosion.....	16-64
16.6.11 Two-Stage Facing (MSE Retaining Wall Systems).....	16-65

16.6.12 (Reserved for Future Use) .....	16-65
16.6.13 Tiered or Superimposed Walls .....	16-65
16.6.14 Back-to-Back Walls .....	16-65
16.6.15 MSE and GRS-IBS Bridge Retaining Walls .....	16-66
16.6.16 Temporary Geotextile-Reinforced MSE Wall .....	16-73
16.7 Prefabricated Modular Walls .....	16-77
16.7.1 Metal and Precast Concrete Bin Retaining Walls .....	16-77
16.7.2 Precast Concrete Crib Retaining Walls .....	16-79
16.7.3 Gabion Walls .....	16-82
16.7.4 Dry Cast Concrete Block Gravity Walls .....	16-84
16.7.5 Wet Cast Concrete Block Gravity Walls .....	16-86
16.8 Non-Gravity (Cantilever) Soldier Pile/Lagging and Sheet Pile Walls .....	16-88
16.8.1 General Considerations .....	16-88
16.8.2 Design Requirements .....	16-89
16.8.3 Soldier Pile/Lagging Walls .....	16-90
16.8.4 Sheet Pile Walls .....	16-90
16.9 Anchored Soldier Pile/Lagging and Sheet Pile Walls .....	16-91
16.9.1 General Considerations .....	16-91
16.9.2 Design Requirements .....	16-91
16.10 Ground Anchors, Deadmen, and Tie-Rods .....	16-93
16.10.1 General Considerations .....	16-93
16.10.2 Anchor Location and Geometry .....	16-94
16.10.3 Ground Anchor Design .....	16-95
16.10.4 Corrosion Protection .....	16-95
16.10.5 Anchor Load Testing .....	16-95
16.10.6 Ground Anchor Proof Testing Schedule .....	16-95
16.10.7 Ground Anchor Performance Testing Schedule .....	16-97
16.10.8 Deadmen or Anchor Blocks .....	16-98
16.10.9 Tie-Rods .....	16-102
16.11 Soil Nail Walls .....	16-102
16.11.1 General Considerations .....	16-102
16.11.2 Wall Footprint and Soil Nail Easement .....	16-103
16.11.3 Design Requirements .....	16-104
16.11.4 Facing .....	16-106
16.11.5 Corrosion Protection .....	16-106
16.11.6 Load Testing .....	16-107
16.11.7 Soil Nail Verification Test Schedule .....	16-107
16.11.8 Soil Nail Proof Test Schedule .....	16-108
16.12 Tangent/Secant Pile Walls .....	16-110
16.13 Slurry/Diaphragm Walls .....	16-110
16.14 References .....	16-111
Appendix 16-A General Requirements for Proprietary Retaining Wall Systems .....	16-114
16-A.1 Overview .....	16-114

16-A.2 Design and Construction Requirements: ..... 16-115

16-A.3 Responsibilities: ..... 16-115

16-A.4 Preapproval Process and Submittal Requirements for Proprietary Retaining Wall Systems ..... 16-117

16-A.5 Responsibility for Preapproval; ..... 16-117

16-A.6 Conditions of Preapproval for Specific Proprietary Retaining Wall Systems..... 16-117

16-A.7 System Updates (Optional) ..... 16-117

16-A.8 Disqualification and Requalification..... 16-118

Appendix 16-B Preapproval Process and Submittal Requirements for Proprietary Retaining Wall Systems:..... 16-119

    16-B.1 Preapproval Process:..... 16-119

    16-B.2 Application for Preapproval of Retaining Wall System:..... 16-121

    16-B.3 Submittal Requirements for Proprietary MSE Retaining Wall Systems..... 16-124

    16-B.4 Submittal Requirements for Proprietary Prefabricated Modular Retaining Wall Systems: ..... 16-131

    16-B.5 Proprietary Retaining Wall System Example Problems (by Preapproval Category):16-136

    16-B.6 Requirements for Proprietary Retaining Wall System Detail Drawings (by Preapproval Category): ..... 16-149

Appendix 16-C Guidelines for Review of Proprietary Retaining Wall System Working Drawings and Calculations..... 16-151

    16-C.1 Geotechnical Design Issues..... 16-151

    16-C.2 External Stability Design..... 16-152

    16-C.3 Internal Stability Design..... 16-153

    16-C.4 Wall Construction Sequence Requirements ..... 16-156

Appendix 16-D Preapproved Proprietary Retaining Wall Systems ..... 16-157

**List Of Tables**

Table 16-1 Foundation Total Settlement Criteria..... 16-35

Table 16-2 Foundation Differential Settlement Criteria ..... 16-36

Table 16-3 Temporary Shoring Systems ..... 16-43

Table 16-4 Temporary Retaining Walls..... 16-47

Table 16-5 Dynamic Load and Equivalent Static Load for Moment Slab Design..... 16-61

Table 16-6 Pressure Distribution ( $p_{dp}$ ) for Reinforcement Pullout and Tributary Height ..... 16-62

Table 16-7 Line Load ( $Q_{dp}$ ) for Reinforcement Pullout ..... 16-62

Table 16-8 Pressure Distribution ( $p_{dy}$ ) for Reinforcement Yield..... 16-63

Table 16-9 Line Load ( $Q_d$ ) for Reinforcement Yield ..... 16-63

Table 16-10 In-Place Porosity vs. Bulk Density, Gabion Basket Rock Fill..... 16-84

Table 16-11 Ground Anchor Proof Test Schedule ..... 16-96

Table 16-12 Ground Anchor Performance Test Schedule ..... 16-97

Table 16-13 Corrosion Protection Levels in Soil Nails .....	16-106
Table 16-14 Soil Nail Verification Tests .....	16-107
Table 16-15 Soil Nail Proof Test Schedule .....	16-109

### List Of Figures

---

Figure 16-1 Bridge Zone .....	16-8
Figure 16-2 Minor Retaining Wall .....	16-9
Figure 16-3 Pay Area .....	16-24
Figure 16-4 Unfactored Static Lateral Earth Pressure with Residual Horizontal Compaction Pressures on Non-deflecting CIP Semi-Gravity and Rigid Gravity Retaining Walls .....	16-33
Figure 16-5 MSE Wall Supporting Bridge Abutment Spread Footing (Geogrid Reinforcements) .....	16-69
Figure 16-6 GRS-IBS Abutment Section .....	16-73
Figure 16-7 Temporary Geotextile-Reinforced MSE Wall .....	16-74
Figure 16-8 Non-Gravity (Cantilever) Soldier Pile and Sheet Pile Wall Heights .....	16-89
Figure 16-9 Anchored Walls: External, Internal, Global and Facing Failure Modes .....	16-93
Figure 16-10 Effect of Anchor Block Location, Active/Passive Earth Pressure and Tie-Rod Resistance .....	16-100
Figure 16-11 Effect of Anchor Block Spacing on Tie-Rod Resistance, Continuous and Individual Anchor Blocks .....	16-101
Figure 16-12 Soil Nail Walls: External, Internal, Global, and Facing Failure Mode .....	16-105
Figure 16-13 Problem # 1 .....	16-139
Figure 16-14 Problem # 2 .....	16-142
Figure 16-15 Problem # 3 .....	16-144
Figure 16-16 Problem # 4 .....	16-147
Figure 16-17 Problem # 5 .....	16-149

### List of Equations

---

Equation 16-1 Theoretical elastic elongation of the unbonded length in verification tests ....	16-108
Equation 16-2 Theoretical elastic elongation of the unbonded length in proof tests .....	16-110



## 16.1 Introduction

Retaining structures are an important part of Oregon’s transportation system. They are included in projects to minimize right of way needs, to reduce bridge lengths at water crossings and grade separations, to minimize construction in environmentally sensitive areas, and to accommodate construction on slopes.

The requirements described in [Chapter 15](#) are based on the Design-Bid-Build method of contracting. ODOT also delivers projects with other contracting methods, such as Design-Build. Design-Build combines the design and construction phases of a project into a single contract. The Design-Build Request for Proposal (RFP) identifies the applicable standards, manuals, guidelines, and additional requirements. While there may be differences contracting methods, the governing design and construction standards are consistent.

Retaining structure performance specifications should reference [Chapter 15](#), with modifications as necessary to fit the contracting method being used.

## 16.2 Retaining Wall Practices and Procedures

### 16.2.1 Retaining Wall Categories and Definitions

#### 16.2.1.1 Retaining Wall Categories

The following retaining wall categories are used in this chapter: Bridge Abutment, Bridge Retaining Wall, Highway Retaining Wall, and Minor Retaining Wall. These categories assist in making decisions regarding retaining wall function, consequences of failure, design, asset management, drafting, and other ODOT practices and procedures. The criteria and guidance based on wall category are not intended to replace engineering analysis or sound engineering judgment—but only to ensure that wall design decisions are consistent, straightforward, and applied equally on all ODOT projects statewide.

The retaining wall categories presented above include “Bridge Retaining Walls” whose performance could adversely influence the stability of a bridge structure **or the approach roadway adjacent to the bridge**. The “Bridge Zone” is a simplified conservative boundary intended to allow quick and easy categorization of retaining walls for a variety of purposes ([Figure 16-1](#)). Retaining walls located partially or fully within the limits of the bridge zone shall by default be defined as “Bridge Retaining Walls” and subject to all applicable requirements in this chapter.

If it is determined that a retaining wall defined as a “Bridge Retaining Wall”, by virtue of being located within the “Bridge Zone”, does not actually influence the stability of the bridge **or the approach roadway adjacent to the bridge**, this default definition may be overridden by clearly identifying the retaining wall as a “Highway Retaining Wall” on the Project Plans. This change in wall category shall be adequately supported by calculations in the retaining wall calculation books.

The retaining wall categories and default definitions are included below:

**Bridge Abutment:** Defined as a structural element at the end of the bridge that supports the end of the bridge span, and provides lateral support for fill material on which the roadway rests, immediately adjacent to the bridge. A bridge abutment provides vertical, longitudinal, and/or transverse restraint through bridge bearings, shear keys, and/or an integral connection with the bridge superstructure.

A bridge abutment is considered to be part of the bridge, and is designed according to applicable sections of the *ODOT Bridge Design Manual (BDM)*, the *ODOT Geotechnical Design Manual (GDM)*, and the *AASHTO LRFD Bridge Design Specifications (AASHTO LRFD)*.

Wingwalls that are monolithic with the bridge abutment are part of the bridge abutment.

In Chapter 15, the terms “end bent” and “abutment” are used interchangeably. On ODOT bridge drawings, however, all bridge support locations are referred to as “bents” and abutments are referred to as “end bents.”

**Bridge Retaining Wall:** A retaining wall that meets all of the following conditions:

1. The retaining wall is located partially or entirely within the Bridge zone ([Figure 16-1](#)).
2. The retaining wall does not meet the definition of bridge abutment.

Design and construction requirements for Bridge retaining walls must be consistent with those for the bridge, unless it is determined that the retaining wall does not influence the stability of the bridge or the bridge approach roadway as noted above.

**Highway Retaining Wall:** A retaining wall that meets all of the following conditions:

1. The wall is located entirely outside of the bridge zone ([Figure 16-1](#)).
2. The wall does not fully meet the definition of a Minor retaining wall.

Highway retaining walls shall not be located inside the Bridge Zone, unless the Agency EOR for the Bridge retaining wall determines that the retaining wall does not influence the stability of the bridge or the approach roadway adjacent to the bridge. Retaining walls or wingwalls separated from the bridge abutment with an expansion joint are bridge retaining walls and should not be considered for highway retaining wall category.

**Minor Retaining Wall:** A retaining wall that meets all of the following conditions:

1. The wall is located entirely outside of the bridge zone ([Figure 16-1](#)).
2. Wall height (H), does not exceed 4.0 feet at any point along the wall ([Figure 16-2](#)).
3. Wall fore slope and back slope are both flatter than 1V:4H within a horizontal distance of H, measured from the nearest point on the wall ([Figure 16-2](#)).
4. Surcharge loading is not allowed on the retaining wall back slope within a horizontal distance of H, measured from the nearest point on the wall ([Figure 16-2](#)).

Figure 16-1 Bridge Zone

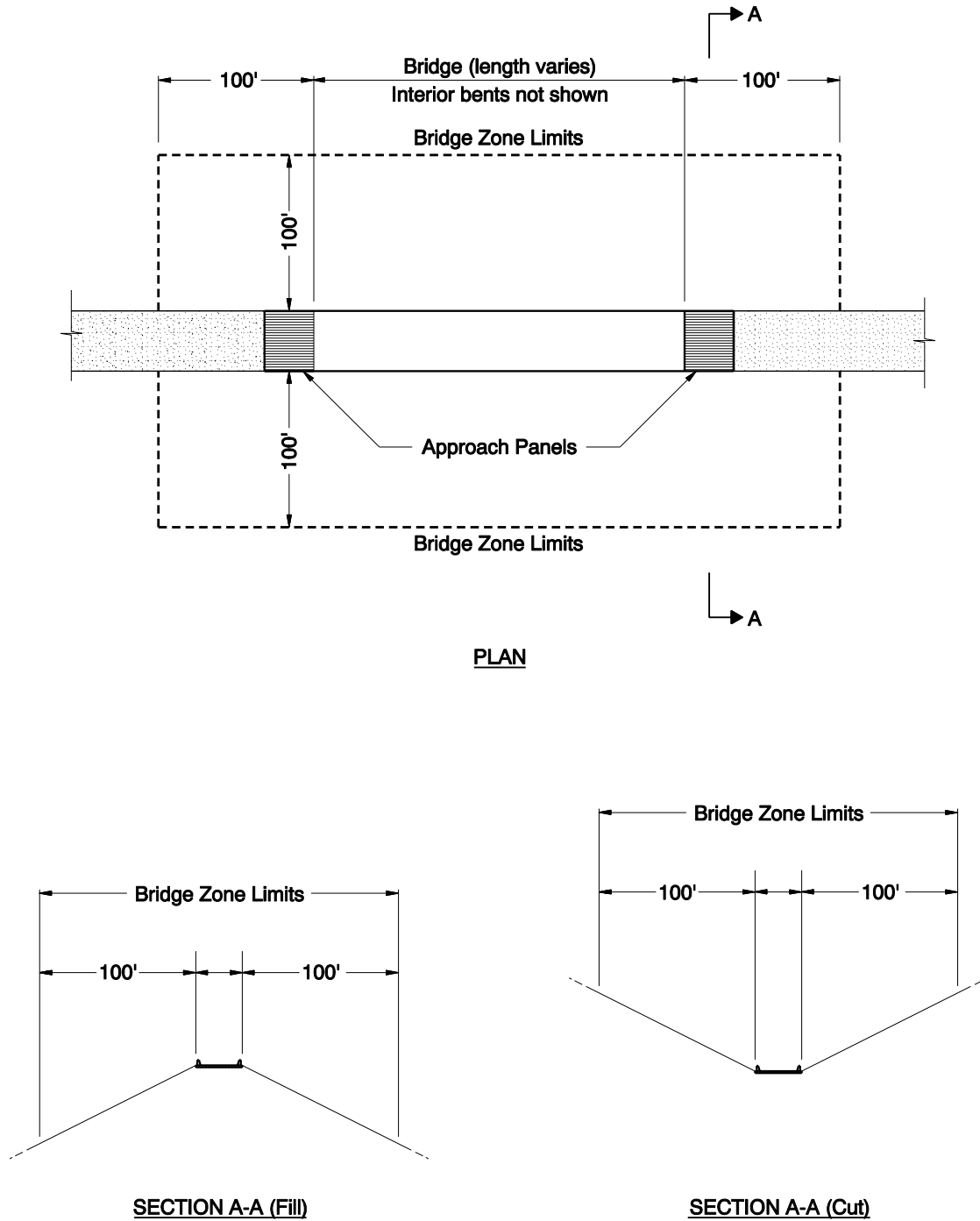
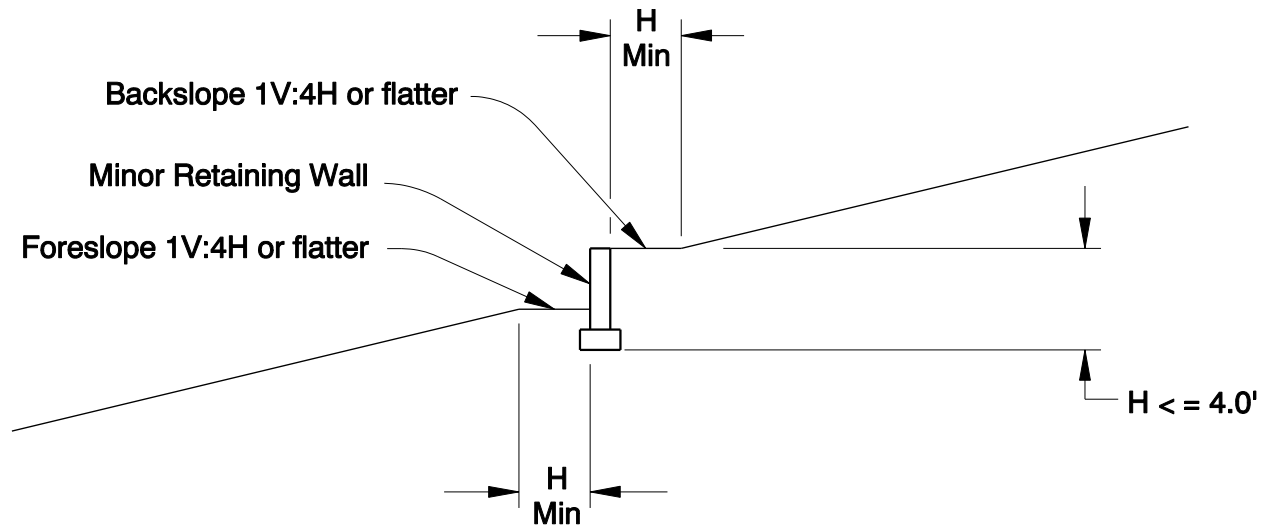
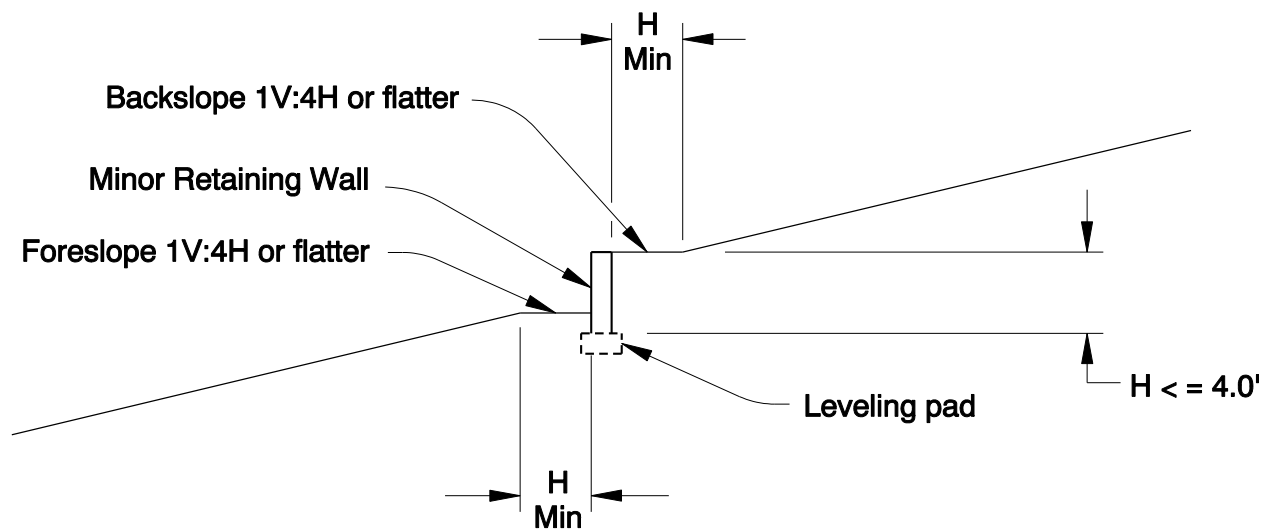

Figure 16-2 Minor Retaining Wall



CAST IN PLACE OR PRECAST CONCRETE MINOR RETAINING WALL



PREFABRICATED MODULAR MINOR RETAINING WALL

## 16.2.1.2 Definitions

In order to describe ODOT practices and procedures for retaining wall systems, the following terms are defined, as used in Chapter 15:

**Bridge Abutment** - See [Section 16.2.1.1](#).

**Bridge Retaining Wall System** - See [Section 16.2.1.1](#).

**Bridge Zone** - See [Section 16.2.1.1](#), Retaining Wall Categories

**Conditions of Preapproval for Proprietary Retaining Wall Systems** – [Appendix 16-D](#) describes the conditions of preapproval for each proprietary retaining wall system. Other uses are not allowed.

**Control Plans** - Plans preparation method used for proprietary retaining wall systems. Control plans can be either “Conceptual” or “Semi-detailed” – See [Section 16.2.5.2](#) and [Section 16.2.8.1](#).

**Cost Reduction Proposal** - Agency procedure that can be used by the Contractor to propose an alternate proprietary retaining wall system. See SS00140.70 in the Oregon Standard Specifications for Construction.

**DAP** - Design Acceptance Phase. See [Section 16.2.3](#).

**Elements and components of Preapproved Proprietary Retaining Wall Systems** - See [Section 16.2.5.2](#).

**GRS-IBS** – Geosynthetic Reinforced Soil Integrated Bridge System. GRS, Geosynthetic Reinforced Soil, is an engineered, well-compacted granular fill with closely spaced layers of geosynthetic reinforcement. GRS-IBS is a method of bridge support that blends the approach roadway into the superstructure using GRS. See [Section 16.6.15.4](#).

**Highway Retaining Wall System** – See [Section 16.2.1.1](#).

**Manufacturer** - The proprietary owner of a retaining wall system or proprietary retaining wall component. Used interchangeably in Chapter 15 with *Vendor*.

**Minor Retaining Wall System** – See [Section 16.2.1.1](#).

**Nonproprietary Retaining Wall System** - A retaining wall system that is fully designed by the Agency.

**Nonproprietary Specification** - A specification that does not specify proprietary products either by name or by specifying requirements that only one proprietary product can meet.

**Preapproved Proprietary Retaining Wall System** - A proprietary retaining wall system that has been granted “preapproved” status by the ODOT Retaining Structures Program, and that may be considered for use on ODOT projects, subject to the “Conditions of Preapproval” for the proprietary system in [Appendix 16-D](#).

**Preapproved Proprietary Retaining Wall System** - When a fully detailed retaining wall system is not shown on the Agency plans, list acceptable preapproved proprietary retaining wall OPTIONS in project special provision SP0A596 or SP0B596.

**Preapproved Proprietary Retaining Wall System Alternates** - When a fully detailed retaining wall system is shown on the agency plans, list acceptable preapproved proprietary retaining wall ALTERNATES in project special provision SP00596.

**Precast Concrete Large Panel Facing** - MSE wall precast concrete facing panel with a face area greater than or equal to 30 square feet.

**Precast Concrete Small Panel Facing** - MSE wall precast concrete facing panel with a face area of 30 square feet or less.

**Proprietary Product** - General term including proprietary retaining wall systems and proprietary retaining wall elements and components.

**Proprietary Retaining Wall System** - A retaining wall system identified in the plans or specifications as a “brand” or trade name, or a retaining wall system so narrowly specified that only a single provider can meet the specification. See [Section 16.2.5](#), [Appendix 16-A](#), [Appendix 16-B](#), [Appendix 16-C](#), and [Appendix 16-D](#).

**Public Interest Finding** - Agency process that can be used to justify the specification of less than three specific proprietary products. See [Section 16.2.6.2](#).

**Retaining Wall Elements and Components** - Elements and components used in the design or construction of either a proprietary retaining wall system or a nonproprietary retaining wall system.

**Retaining Wall Nonproprietary Elements and Components** - Retaining wall elements and components that are not protected by a brand name, trademark, or patent.

**Retaining Wall Proprietary Elements and Components** - Retaining wall elements and components that are protected by a brand name, trademark, or patent. Also, see Sole Source Specification.

**Retaining Wall System** - An engineered system of interacting structural and geotechnical retaining wall elements and components designed to restrain a mass of earth, and satisfying all applicable design requirements. The terms *retaining wall system*, *retaining structure*, and *retaining wall* are used interchangeably throughout Chapter 15.

**Retaining Wall System Type** - See [Section 16.2.4.2](#).

**Sole Source Specification** - Plans or specifications that require proprietary products either by name or by a requirement that only one proprietary product can meet. Sole source specifications **without consideration of alternates or approved equal** are not allowed in the project plans or specifications, unless a sole source specification is justified by an approved **State Exemption Order Exemption from Approved Equal Requirement**. To assure competitive bidding when proprietary products are specified, as many acceptable proprietary products as possible should be listed. See [Section 16.2.8.3](#) for proprietary items (including sole sourcing).

**Standard Drawing Retaining Wall System** - A non-proprietary retaining wall system for which a standard design is provided in the Oregon Standard Drawings (look in “[Bridge 700 Walls](#)”)

Internal and external stability have been designed in accordance with AASHTO Standard Specifications for Highway Bridges, except for bearing capacity, settlement, and overall stability, which are site specific. The wall designer is responsible for applying the standard drawing to a specific site, and for verifying all engineering assumptions stated on the standard drawing.

## 16.2.2 General Steps in a Retaining Wall Project

### 1. Consider whether a retaining wall is the best solution.

Consider alternatives such as acquiring additional right of way, flattening or steepening the slope, or building a reinforced soil slope.

### 2. Determine suitable retaining wall system type.

The designer for the retaining wall system determines which wall system type or types are suitable for a given wall location. See [Sections 16.2.4.1](#) and [Section 16.3](#) for general selection criteria, and see [Section 16.4](#) through [Section 16.13](#) for specific wall type selection criteria. [Section 16.2.4.2](#) lists retaining wall system types that may be considered for use on ODOT projects.

### 3. Select option.

- **Option 1:** Nonproprietary Design

Under Option 1, the designer completely designs the retaining wall system, and provides fully detailed plans for one type of retaining wall system. See [Section 16.2.6](#) for more information on nonproprietary retaining wall systems.

- **Option 2:** Proprietary Design

Under Option 2, the designer provides control plans, rather than a complete retaining wall system design, and the retaining wall system Manufacturer completes the design. See [Section 16.2.5](#) for more information on proprietary retaining wall systems. Before selecting this option, verify that a sufficient number of preapproved proprietary retaining wall systems are available for competitive bidding of the retaining wall system type selected. Alternatively, a request to use a sole source specification may be submitted to the Agency. See [Section 16.2.8.3](#) for competitive bidding of proprietary items, including sole sourcing.

### 4. Perform design calculations as required.

See *AASHTO LRFD Bridge Design Specifications* and ODOT exceptions and additions to AASHTO in [Section 16.3](#) and [Sections 16.4](#) through [Section 16.13](#). For proprietary retaining wall system design responsibilities, see [Appendix 16-A](#).

5. **Prepare contract plans.**

See [Section 16.2.8.1](#) Elements of Contract Plans for Retaining Wall Systems.

6. **Prepare contract special provisions.**

Edit “Boilerplate” special provision SP0A596, SP0B596, and/or SP0C596 as appropriate, for the selected retaining wall system types and selected contract letting. For nonproprietary designs, include estimated quantities for the items listed in SP00596. For proprietary designs, details of the system are not known until after contract letting, so do not include estimated quantities in SP00596. See [Section 16.2.8.3](#) for more information on special provisions.

7. **Prepare estimates.**

The designer for the retaining wall system is responsible for estimating quantities for retaining wall bid items, and providing them to the project specifications writer. See [Section 16.2.8.4](#) for more information on quantity estimates for retaining wall systems.

The designer for the retaining wall system is also responsible for estimating bid item unit prices. Include cost factors for location, size of wall, inflation, and complexity. Do not include cost factors for mobilization, engineering, and contingencies, all of which will be included by the specifications writer on a project wide basis (See [Section 16.2.8.4](#)).

Also, provide an estimate for the time required for construction using a graph format showing all critical stages of the construction, and for the cost of design assistance during construction.

8. **Prepare calculation book.**

As required (See [Section 16.2.8.5](#)).

## 16.2.3 Retaining Wall Project Schedule

Review the project schedule as soon as it is available: typically at project kick-off. Understand the scope, work items, sequence and milestone submittals. Geotechnical exploration, geotechnical report, and retaining wall design process and milestone deliverables for a typical design-bid-build retaining wall project may include:

### SCOPING

- Desk search for existing site geologic data relevant to proposed project scope



- Participate in project scoping trip and communicate geologic and geotechnical considerations of the project
- Coordinate, develop and submit subsurface investigation and geotechnical design scoping estimate (scope, schedule, and budget) interactively with affected project disciplines.

#### KICKOFF

- Review the scope, schedule and budget for the work ahead. Communicate if changes or corrections are needed.

#### DESIGN ACCEPTANCE PHASE (DAP) (also referred to as TYPE, SIZE & LOCATION)

- Geotechnical Design Deviation Process (as early as possible)
- Perform Geotechnical Exploration
- Submit Preliminary Geotechnical Report
- Submit geotechnical portion of Type Size & Location (TS&L) Design Report
- Determine right of way needs
- Submit DAP (50% complete) Retaining Wall Plans and Cost Estimate

#### PRELIMINARY DESIGN PHASE

- Resolve DAP review comments
- Submit Preliminary (70% complete) Retaining Wall Plans and Cost Estimate

#### ADVANCE PLANS, SPECIFICATIONS & ESTIMATE PHASE

- Resolve Preliminary Plans comments
- Submit Final Geotechnical Report
- Submit Geotechnical Data Sheets
- Submit Advance Plans (95% complete) Retaining Wall Plans, Specifications and Cost Estimate

#### FINAL PLANS, SPECIFICATIONS & ESTIMATE PHASE

- Resolve Advance Plans comments
- Submit draft Final Plans (Retaining Wall Plans, Specifications and Cost Estimate)
- Resolve final review comments
- Submit stamped and signed Retaining Wall Plans and Geotechnical Data Sheets
- Submit stamped and signed signature sheets for special provisions
- Assemble Calculation Books
- Submit construction support estimate

#### ADVERTISEMENT, BID, and AWARD PHASE

- Provide Construction Office with responses to Contractor requests for information, clarification
- Prepare and submit addenda to Procurement Office as needed

#### CONSTRUCTION PHASE

- Provide Construction Office support with shop drawing and other submittal reviews
- Visit construction sites as needed
- Provide stamped, signed and updated calculation books and as-constructed retaining wall plans after completion of construction

## 16.2.4 Selection of Retaining Wall System Type

### 16.2.4.1 General Criteria for Selection of Retaining Wall System Type

When preparing a list of acceptable wall types for a specific project, the wall designer must consider [Sections 16.3](#) through [Section 16.13](#), as well as the general considerations listed below:

General Considerations include:

1. Project Category
  - a. Permanent or temporary wall: A temporary wall must meet the physical requirements with very little concern for aesthetics or long-term design life.
  - b. Bridge retaining wall, Highway retaining wall, or Minor retaining wall.
2. Site Conditions Evaluation
  - a. Cut or fill: This condition needs to be evaluated because some wall types do not work well for one or the other. Determine if top down construction is required for a cut.
  - b. Soil profile and site geology: Evaluate the project for variations in wall height and blending the wall into the site. Also, evaluate slope instability and landslide hazards.
  - c. Foundation conditions and capacity: The foundation soil must be evaluated for capacity to support the wall system.
  - d. Foundation soil mitigation required/feasible: While certain soil conditions may not support certain wall types, it may be economical to mitigate foundation soil problems to accommodate these wall types.
  - e. Groundwater table location: Consider whether ground water will increase lateral soil pressure on the wall or increase the corrosion potential. Also, evaluate the impact of surface run-off and subsurface drainage conditions.
  - f. Underground utilities and services: If utilities interfere with soil reinforcement or other wall elements, consider other wall systems.
  - g. Other structures adjacent to site: Determine if adjacent structures may be affected by wall construction such as pile driving or lack of lateral support.
  - h. Corrosive environment and effect on structural durability: Evaluate the site for conditions that may cause accelerated corrosion or degradation of the retaining wall system.
3. Geometry and Physical Constraints
  - a. Height limitations for specific systems: Check the height limits for the wall systems as well as practical design limits.

- b. Limit on radius of wall on horizontal alignment: Evaluate wall system to accommodate any radius situation or adjust radius to meet wall system.
  - c. Allowable lateral and vertical movements, foundation soil settlements, differential movements: Determine allowable movements and choose wall systems that will accommodate the movements.
  - d. Resistance to scour: If the hydraulics study determines potential scour condition exists, provide sufficient embedment depth or provide scour protection.
  - e. Wall is located near a bridge: Determine which wall systems are compatible with the bridge.
4. Constructability Considerations. The following items should be considered when evaluating the constructability of each wall system for a specific project:
    - a. Scheduling considerations (e.g. weather, preloads wait times)
    - b. Formwork, temporary shoring
    - c. Right of way boundaries
    - d. Complicated horizontal and vertical alignment changes
    - e. Site accessibility (access of material and equipment for excavation and construction)
    - f. Maintaining existing traffic lanes and freight mobility
    - g. Vibrations
    - h. Noise
    - i. Availability of materials (e.g., MSE backfill)
  5. Environmental Considerations
    - a. Minimum environmental damage or disturbance: Consider the impact of wall systems on environmentally sensitive areas.
    - b. Consider the impact of wall type on the environmental permitting process.
  6. Cost
    - a. Right of way purchase requirements: Evaluate the cost of additional right of way if it is required to use a given wall system.
    - b. Consider the total costs associated with wall construction, rather than the cost of individual wall systems.
  7. Aesthetic Considerations
    - a. Determine if wall type and/or architectural treatment meets aesthetic requirements at the site.
  8. Mandates by Other Agencies
    - a. Determine whether wall type complies with mandates by other agencies.
  9. Requests made by the Public
    - a. Determine if wall type is consistent with public input for the site.
  10. Traffic Barrier
    - a. Determine whether wall type can accommodate traffic barrier if required at the site.
  11. Protective Fencing

- a. Determine whether wall type can accommodate protective fencing if required at the site.

### **16.2.4.2 Retaining Wall System Types**

Retaining wall system types for which adequate design guidance is available are listed in this section. This list will be updated as new guidance becomes available.

Only the wall types listed below, or walls designed in accordance with [Section 16.2.7](#), shall be considered for use on Agency projects:

- Type 1A: CIP Concrete Rigid Gravity Retaining Wall System
- Type 2A: Precast Concrete Crib Prefabricated Modular Retaining Wall System
- Type 2B: Precast Concrete Bin Prefabricated Modular Retaining Wall System
- Type 2C: Metal Bin Prefabricated Modular Retaining Wall System
- Type 2D: Gabion Prefabricated Modular Retaining Wall System
- Type 2E: Dry Cast Concrete Block Prefabricated Modular Retaining Wall System
- Type 2F: Wet Cast Concrete Block Prefabricated Modular Retaining Wall System
- Type 2G: Precast Concrete Monolithic Panel Facing and Stem Modular Retaining Wall System
- Type 3A: MSE Retaining Wall System with Dry Cast Concrete Block Facing
- Type 3B: MSE Retaining Wall System with Wet Cast Concrete Block Facing
- Type 3C: MSE Retaining Wall System with Precast Concrete Small Panel Facing
- Type 3D: MSE Retaining Wall System with Precast Concrete Large Panel Facing
- Type 3E: MSE Retaining Wall System with Welded Wire Facing
- Type 3F: MSE Retaining Wall System Gabion Facing
- Type 3G: MSE Retaining Wall System with Two-Stage Facing - CIP or Precast Concrete (excluding Type 3H), or Sprayed on Concrete/Mortar Fascia (Constructed after Welded Wire Facing is Installed).
- Type 3H: MSE Retaining Wall System with Precast Concrete "Full Height Panel" Facing
- Type 3J: MSE Retaining Wall System with Geosynthetic Facing
- Type 3K: GRS-IBS Retaining Wall System with Dry Cast Concrete Block Facing
- Type 4A: CIP Concrete Cantilever Semi-Gravity Retaining Wall System
- Type 5A: Soldier Pile Retaining Wall System
- Type 5B: Sheet Pile Retaining Wall System
- Type 5C: Tangent Pile Retaining Wall System
- Type 5D: Secant Pile Retaining Wall System
- Type 5E: Slurry (Diaphragm) Retaining Wall System
- Type 5F : Micropile Retaining Wall System
- Type 6A: Soldier Pile Tieback Retaining Wall System
- Type 6B: Anchored Sheet Pile Retaining Wall System
- Type 7A: Soil Nail Retaining Wall System
- Type 8A: Temporary Geotextile Reinforced Wrapped Face MSE Retaining Wall System

Retaining wall Types 5A, 5B, 5C, 5D, 5E, 5F, 6A, 6B, and 7A listed above may be used as temporary shoring in accordance with the requirements in SP00510 and [Section 16.3.26](#).

Retaining wall Type 8A (Temporary Geotextile Reinforced Wrapped Face MSE) shall be designed in accordance with [Sections 16.6.16](#) and [16.3.27](#).

Retaining wall Types 2B, 2C, 2D, 2F, 3E, and 3F, used as temporary retaining wall systems, shall be designed in accordance with the criteria in [Section 16.3.27](#).

Design two-stage facing for retaining wall Type 3G (MSE Retaining Wall with Two-Stage Facing) in accordance with the requirements in [Section 16.6.11](#).

## **16.2.5 Proprietary Retaining Wall Systems**

See [Appendix 16-A: General Requirements for Proprietary Retaining Wall Systems](#)

### **16.2.5.1 Agency Control Plans for Proprietary Retaining Wall Systems**

“Control Plans” are prepared to show requirements for proprietary retaining wall systems. The specific details shown on control plans depend on the retaining wall system types selected.

If multiple dissimilar (proprietary) retaining wall system types are acceptable (e.g., Types 2A-2F and Types 3A-3G in [Section 16.2.4.2](#)), the plans should only show details that are generally applicable to all selected retaining wall system types. Plans showing only general details for multiple dissimilar wall system types are considered “Conceptual” control plans.

It is sometimes necessary to use conceptual control plans, but this option is generally not recommended. With this option, the system type is not known until after bid letting, which can lead to difficulties in coordination between design disciplines.

The primary advantage of this plan preparation method is increased competitive bidding because of specifying several proprietary wall types in a set of plans.

If it is determined that only very similar retaining wall system types are acceptable, the plans should show as many details as possible without infringing on proprietary details and without creating a sole source specification. See [Section 16.2.8.3](#) for more information on sole source specifications.

Minimum information required on control plans is listed in [Section 16.2.8.1](#).

### **16.2.5.2 Elements of Preapproved Proprietary Retaining Wall Systems**

Elements and components of preapproved proprietary retaining wall systems are preapproved as part of a specific retaining wall system. Approval of a specific system does not constitute approval of individual elements and components for other use in other systems. Non-system approval of individual elements and components may be a prerequisite to system approval (as

in the case of geogrids that must be on the ODOT QPL) but the component must still be specifically approved for use in a specific proprietary system.

## **16.2.6 Nonproprietary Retaining Wall Systems**

Nonproprietary retaining wall systems shall meet the design requirements of [Sections 16.3](#) through [Section 16.14](#). Also, see [Section 16.2.4.2](#).

### **16.2.6.1 Agency Detailed Plans for Nonproprietary Retaining Wall Systems**

Project plans for nonproprietary retaining wall systems shall include all details that are needed to complete the work. Minimum information required on nonproprietary retaining wall systems is listed in [Section 16.2.8.1](#).

### **16.2.6.2 Components of Nonproprietary Retaining Wall Systems**

Nonproprietary retaining wall systems may contain both proprietary and nonproprietary elements and components. Clearly specify all requirements for both proprietary and nonproprietary elements and components of a nonproprietary retaining wall system in the project plans and specifications. Also, see [Section 16.2.8.3](#).

## **16.2.7 Unique Nonproprietary Wall Designs**

Nonproprietary retaining wall systems not listed in [Section 16.2.4.2](#) are considered “Unique” retaining wall system types. These walls are not specifically addressed by AASHTO, FHWA, or Agency design manuals. It is recognized, however that unique retaining wall system types are sometimes needed. Unique retaining wall system types may be considered for use on ODOT projects if all of the following requirements are met:

- The wall is a fully designed nonproprietary retaining wall system.
- The design is performed in accordance with the following list in order of precedence:
  - This ODOT Geotechnical Design Manual (GDM)
  - AASHTO Standard and Guide Design Specifications
  - U.S. Department of Transportation Federal Highway Administration (FHWA) design manuals
- The designer is required to meet Agency Policy and related technical guidance found in the [Project Delivery Toolbox](#).

## **16.2.8 Details of Contract Documents**

In Design-Bid-Build construction projects, bidding is very competitive, and it should be assumed that the contractor will base the bid strictly on the contract documents. Contract

documents should show as much detail as possible (in line with design responsibility) and avoid omission of needed details.

### **16.2.8.1 Elements of Contract Plans for Retaining Wall Systems**

Fully detailed plans used for nonproprietary retaining wall systems [Section 16.2.6](#) should include all information and details needed to bid and build the wall. Control Plans used for proprietary retaining wall systems [Section 16.2.5](#) are either “Conceptual” or “Semi-Detailed”:

- “Conceptual” control plans should include information that is generally applicable to all specified retaining wall system types.
- “Semi-Detailed” control plans should include as many details as possible without infringing on proprietary rights and without creating a sole source specification.

See [Section 16.3.23](#) for proprietary Minor retaining walls. See [Section 16.3.24](#) for nonproprietary Minor retaining walls.

#### **Contract Plans Checklist**

The following items should be included (as applicable) on all contract plans regardless of plan preparation method involved, unless noted otherwise:

- Plan
- Elevation
- Typical Section
- General Notes
- Calculation book number (if required in [Section 16.2.8.5](#))
- Structure number (if required in [Section 16.2.8.6](#))
- Vicinity Map
- Retaining wall category (Bridge, Highway, or Minor retaining wall)
- Wall control line
- Right of way and easement limits
- Existing utilities and existing drainage facilities
- A grade line diagram at the wall control line, including curve data, if applicable
- Stations at beginning and end of the retaining wall and at all profile break points along the wall control line
- Elevations at beginning and end of the retaining wall and at all profile break points along the top of the retaining wall at the wall control line
- Elevations along bottom of wall (if not footings), along top of footing (if footings), and along top of leveling pad (if leveling pad)
- Original and final ground elevations in front of and back of retaining wall
- At stream locations, extreme high water, and ordinary high water elevations
- Foundation data or geotechnical data
- Location, depth, and extent of any unsuitable material to be removed and replaced, and any ground improvement details

- Minimum wall embedment
- Minimum/Maximum front face batter
- Minimum reinforcement length for overall and external stability (MSE walls)
- Retaining wall loading diagram
- Magnitude, location and direction of applicable external loads including dead load surcharge, live load surcharge, construction loads (e.g., crane loads, material stockpile loads), barriers (vehicle, bicycle, and/or pedestrian), luminaire and sign supports, bridge end panels, and bridge abutments.
- Seismic design parameters
- Geotechnical design parameters
- Material requirements
- Design standards
- Aesthetic requirements
- Structural details
- Pay Limits for bid items
- Construction sequence requirements, if applicable, including traffic control, access, stage construction sequences, temporary shoring, and ground improvement
- Details of applicable retaining wall appurtenances including utilities and drainage facilities (e.g., storm sewer pipes), copings, barriers or rails (e.g., vehicle, bicycle, and/or pedestrian), guardrail posts, luminaire and sign supports (including conduit locations), fencing, bridge end panels, and bridge abutments. See [Section 16.3.23](#) for proprietary Minor retaining walls. See [Section 15.3.24](#) for nonproprietary Minor retaining walls.

**Note:**

*Because of the interaction between bridges and Bridge retaining walls, bridge plans should show the locations of Bridge retaining walls as well as the wall structure number. Bridge retaining wall plans should show the location of bridge as well as the bridge structure number.*

**Drafting Related Items**

- GRS-IBS abutments, bridge abutments and wingwalls monolithic with abutments have the same structure number as the bridge and are included within the plan set for the bridge structure.
- MSE retaining walls at spread footing or pile foundation supported bridge abutments have unique structure numbers from the bridge structure. Locate these bridge retaining wall details on bridge series sheets within the plan set for the bridge structure according to the Bridge CAD Manual.
- Similar to MSE retaining walls at bridge abutments, locate plan detail sheets for retaining walls near substructure units on bridge series sheets within the plan set for the bridge structure. Obtain unique structure numbers for walls not integral with the bridge.
- Retaining walls within the bridge zone but outside the limits of the bridge have unique structure numbers from the bridge. Locate these bridge retaining wall plans on their own bridge series sheets following the bridge structure plan set.
- Highway retaining walls have unique structure numbers and are located on geotechnical plan series sheets.



- Minor retaining walls are not assigned structure numbers and are placed on geotechnical plan series sheets.

For more information on drafting related items, see the [Contract Plans Development Guide](#) (most current version), the [Bridge CAD Manual](#), and the [Geo-Environmental Drafting Program website](#).

### **Standard Specifications**

Standard construction specifications for permanent retaining walls located in the 2021 *Oregon Standard Specifications for Construction* include 00596A Mechanically Stabilized Earth Retaining Walls, 00596B Prefabricated Modular Retaining Walls, and 00596C Cast-in-Place Concrete Retaining Walls. Additional specifications are planned in the near future for Soil Nail Retaining Walls, Soldier Pile Retaining Walls, and Sheet Pile Retaining Walls.

## **16.2.8.2 Special Provisions**

Include applicable retaining wall special provisions on all projects containing retaining walls. Always download the latest version of the applicable “boiler plate special provisions,” edit as required, and include in the contract documents.

“Boiler Plate” special provisions include the latest updates to Standard Specifications as well as project-specific information such as acceptable preapproved proprietary retaining wall systems, geotechnical, and seismic design parameters for proprietary wall design, and estimated quantities.

Provide the estimated wall area for both proprietary and nonproprietary walls in the Special Provisions. For nonproprietary retaining wall systems, include estimated quantities for incidental items (shoring, excavation, reinforced backfill, leveling pads, wall drainage/filter systems, and standard coping). For proprietary retaining wall systems where details of the wall construction are not known until after the construction contract is awarded, do not include estimated quantities for incidental items.

FHWA issued a final rule in the Federal Register on September 27, 2019, rescinding the long-standing regulatory provisions for patented or proprietary products in 23 CFR 635.411(a)-(e). This rule provides greater flexibility and encourages innovation in the selection of proprietary or patented materials. It eliminates the requirements limiting the use of Federal funds in paying for patented or proprietary materials, specifications, or processes. However, ORS 279C.345 still requires approval if a sole source specific item is being required on a project and alternates will not be considered for use as approved equal.

When specifying proprietary retaining wall systems or elements and components, competitive bidding practices are required.

ODOT Project Controls Office has rescinded the Letter of Public Interesting Finding and/or Exemption from Approved Equal Requirement template, and replaced it with the [State Exemption Order – Exemption from Approved Equal Requirement](#) template. The requirements for justification of the request, associated costs, procurement method, alternatives and Buy

America have not changed. The submittal and approval process for the new template will not change, they will still be submitted to the Pre-Letting Specialist for review, processing and approval by the Project Controls Office Manager.

Also, include related special provisions such as SP00256, SP00330, SP00350, SP00430, SP00440, SP00510, SP00530, SP00540, and SP2320 as applicable. Download "[Boilerplate Special Provisions](#)".

### **16.2.8.3 Quantity and Cost Estimates**

Each project that goes to bid letting includes a schedule of bid items. The schedule of bid items is [a list of items](#) that the Contractor must bid on, and includes the standard bid item number, standard description, and quantity for each bid item.

The bid item quantity for retaining wall systems is "Lump Sum," and includes all labor, materials, and incidentals necessary to complete the work as specified. A "pay area" diagram showing the limits of the retaining wall bid item should be provided on the project plans. The "pay area" is typically bounded by the beginning and end of the wall, top of the wall (excluding wall coping), and top of the footing or leveling pad. If no footing or leveling pad exists, the bottom of the wall is used

[\(Figure 16-3\)](#). Standard copings are considered incidental to the wall pay item, but sidewalk copings, type "F" traffic barrier copings, moment slabs, and fencing are considered appurtenances and should be included as separate bid items. See [Section 16.2.8.3](#) for more information on "estimated quantities."

The format of the quantity estimate and responsibility for estimating costs and cost factors such as inflation, job location, mobilization, engineering, and contingencies should be determined on a project specific basis by talking with the project specifications writer.

Figure 16-3 Pay Area

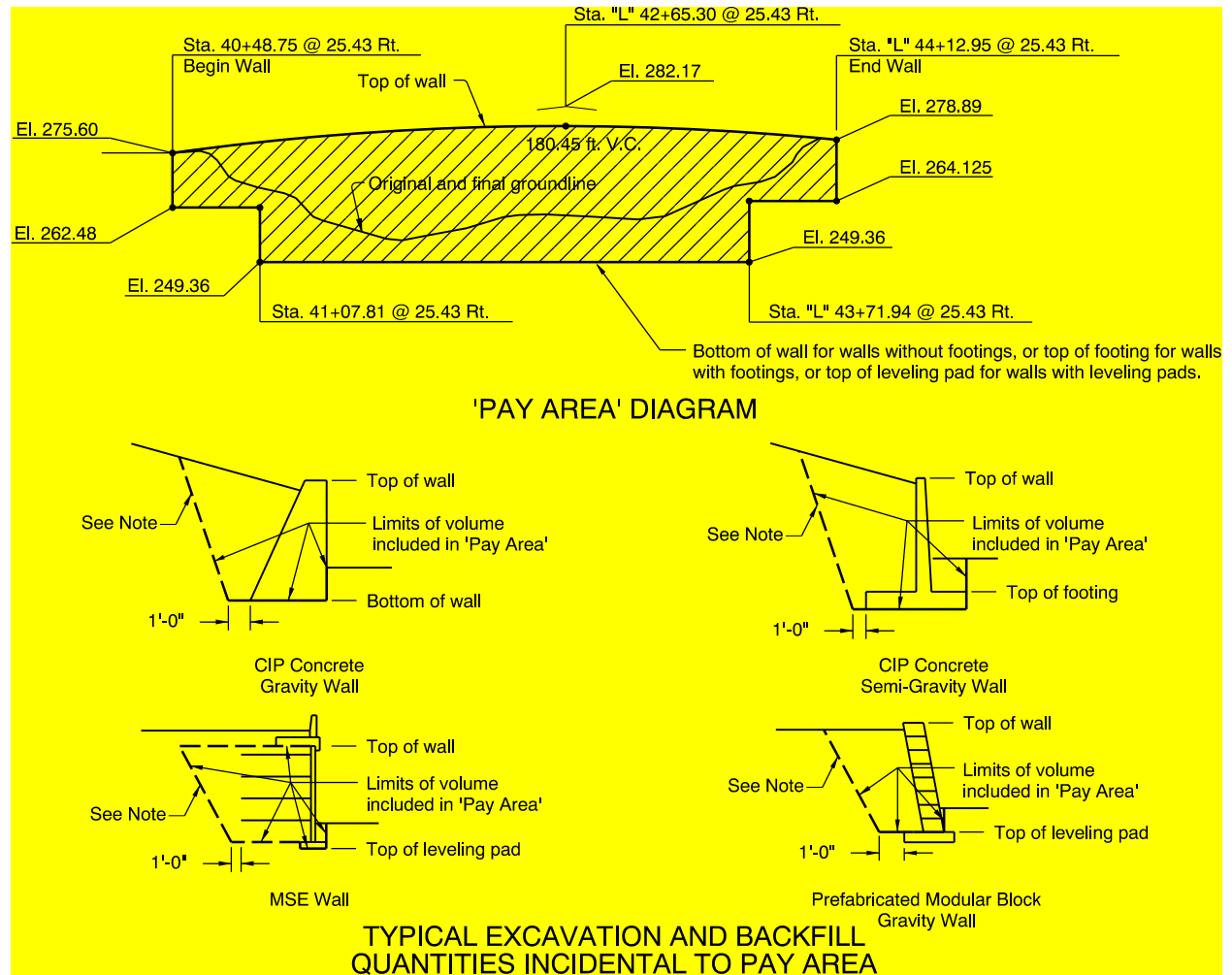

Note: Detail minimum backfill limits to include the active wedge so that lateral earth pressure can be controlled.

### 16.2.8.4 Calculation Books

This section contains calculation book guidelines for bridge abutments and retaining wall systems.

Retaining walls that require calculation books:

- **Bridge Abutments:** Bridge abutments are considered part of the bridge calculations, and bridge abutment calculations shall be included in the bridge calculation book. Bridge calculation books are covered in the ODOT *Bridge Design Manual (BDM)*.
- **Bridge Retaining Walls:** Calculations for each retaining wall structure number shall be located in a separate calculation book or in a separate section of a calculation book. Because of the interaction between the bridge and the associated Bridge retaining wall(s), the bridge calculation book and the Bridge retaining wall calculation books should reference one another.

- **Highway Retaining Walls:** Calculations for each retaining wall structure number shall be located in a separate calculation book or section of a calculation book.
- **Minor Retaining Walls:** Calculation books are not required for Minor retaining walls.

### Calculation Book Numbers

To obtain retaining wall calculation book numbers, send an email request to:

[bridge@odot.state.or.us](mailto:bridge@odot.state.or.us).

### Calculation Book Contents

The following items should be included in calculation books:

- **Title Page:** Title page with structure number, drawing numbers, calculation book number, key number, and construction contract number.
- **Table of Contents**
- **Design Calculations:** Structural and geotechnical calculations performed by (or under the control of) the POR. Show all of your design assumptions, design steps and design methods. Include detailed explanations and sample hand calculations for all computer printouts.
- **Design Check:** Design check of design calculations. The level of detail to be checked varies with the complexity of the project and the experience levels of the Designer and Checker.
- **Design Calculations (by Manufacturer):** Calculations submitted by the Manufacturer for proprietary retaining wall systems, along with Agency review comments.
- **Geotechnical Report:** Include a copy of the Geotechnical Report.
- **Special Provisions:** Include Special Provisions that are applicable to retaining walls.
- **Cost Estimates**

### Calculation Book Submittal

Submit the completed calculation book to the Retaining Wall Program for archiving:

Oregon Department of Transportation- Geo-Environmental Section  
Engineering and Asset Management Unit  
4040 Fairview Industrial Dr. SE, MS #6  
Salem, OR 97302-1142  
Phone 503-986-3252 Fax 503 986 3249

For proprietary retaining wall systems, include a copy of the stamped design calculations submitted by the Manufacturer, as well the Agency review comments for the design calculations submitted by the Manufacturer of the proprietary retaining wall system.

## **16.2.8.5 Structure Numbers and Structure Naming Convention**

Structure numbers are required for Bridge retaining wall systems and Highway retaining wall systems, but are not required for Minor retaining wall systems. For asset management

purposes, the retaining wall structure number shall be unique to the retaining wall and shall not be shared with other structures.

Sometimes adjacent retaining walls must be considered separate walls for asset management purposes. The following sections provide guidance on whether adjacent retaining walls are considered a single structure (with a single structure number), or multiple structures (with multiple structure numbers).

Walls meeting all of the following conditions (as applicable) shall be considered a single structure and shall use a unique structure number:

- The wall must be continuous. Note that continuous walls may contain construction joints, expansion/contraction joints, slip joints, angle points, and steps.
- The wall must consist of a single retaining wall system type.
- For proprietary retaining wall systems, the wall must consist of a single proprietary retaining wall system.
- The wall must be constructed at the same time as part of one project.

Walls meeting any of the following conditions (as applicable) shall be considered separate structures, each with a unique structure number:

- Walls separated by gaps (except as noted above).
- Walls constructed at different times.
- Walls that are not part of the same retaining wall system type.
- Proprietary retaining walls that are not part of the same proprietary retaining wall system.

The drafter typically obtains structure numbers along with drawing numbers using the [ODOT Bridge Data System \(BDS\)](#).

Provide the drafter with BDS input as needed. Also see [Section 15.2.8.1](#).

Follow the wall naming convention contained in the current structure-naming document on the [Bridge Engineering](#) website.

## **16.3 Design Requirements: General Wall Design**

### **16.3.1 Design Methods**

Retaining structures shall be designed using the Load and Resistance Factor Design (LRFD) method whenever possible. Retaining structures shall be designed in accordance with the following documents:

- ODOT Geotechnical Design Manual (GDM); and
- AASHTO LRFD Bridge Design Specifications

The most current versions or editions of the above referenced documents shall be used, including all interim revisions and technical bulletins modifying these documents. In case of conflict or discrepancy, the ODOT GDM design requirements shall supersede those in

AASHTO LRFD. The references listed in this chapter provide additional design and construction guidance for retaining walls—but should be considered supplementary to the ODOT GDM and AASHTO LRFD documents listed above.

Most FHWA manuals listed as ODOT design references were not developed for LRFD design. Wall types for which LRFD procedures are not currently available shall be designed using Allowable Stress Design (ASD) or Load Factor Design (LFD) procedures as indicated (in full or by reference) in this chapter. The following subsections describe ODOT exceptions and additions to the referenced standards for general retaining wall design, and include discussions of special design topics applicable to general retaining wall design.

## **16.3.2 Wall Facing Considerations**

The wall facing must meet all project requirements, including appearance (aesthetics), face angle or batter, horizontal alignment, internal and external stability requirements, environmental conditions (e.g. UV exposure, corrosion, freeze-thaw, and runoff effects), and compatibility with the retaining wall system.

Typical MSE retaining wall facing options include the following:

- Dry cast concrete block (MSE and gravity wall systems)
- Wet cast concrete block (MSE and gravity wall systems)
- Precast concrete panel (small and large facing units)
- Welded wire
- Sprayed on concrete/mortar facing on welded wire facing
- Gabion (tied wire baskets filled with rock)
- Cast-in-place concrete
- Geotextile sheet (wrapped-face construction)
- Geocell

## **16.3.3 Wall Face Angle (Batter)**

Wall face batter should take into consideration several factors, including constructability, maintenance, appearance, and the potential for negative batter. Negative batter typically results from poor construction practice, heavy construction loads near the wall face, and/or excessive post-construction differential foundation settlements. Typical design wall face batters for conventional retaining walls are as follows:

### **16.3.3.1 CIP Gravity and Cantilever Walls**

The finish face batter is typically designed no steeper than approximately 5° (12v:1h). Steeper face batters have been used, however, for walls up to approximately 20 ft. in height and transitional wall sections that match existing vertical walls.

### 16.3.3.2 Mechanically Stabilized Earth (MSE) Walls

The finish face batter of precast concrete panel MSE walls is typically designed to be as steep as  $0^\circ$  (vertical). This may require a positive batter allowance during construction to prevent a negative wall face batter due to normal wall construction deformation, post-construction foundation settlement, and/or heavy surcharge loads.

The finish face batter of MSE retaining walls with dry cast concrete block facing units is typically designed to be no steeper than approximately  $1^\circ$  (57v:1h).

The finish face batter of MSE retaining walls with wet cast concrete block facing units is typically designed to be as steep as  $3^\circ$  (19v:1h) to  $6^\circ$  (10v:1h).

Temporary wrapped-face type geotextile MSE walls, where a small negative batter would not impair wall stability or function, are typically designed at a finish batter as steep as  $0^\circ$  (vertical).

### 16.3.3.3 Prefabricated Modular Walls

Prefabricated modular (gravity) retaining walls, which include crib, bin, gabion, dry cast concrete block, and wet cast concrete block walls, are typically battered between approximately  $3^\circ$  (19v:1h) and  $10^\circ$  (6v:1h).

## 16.3.4 Horizontal Wall Alignment

Retaining wall selection should consider project-specific horizontal alignment requirements. Smaller facing units, such as dry cast concrete blocks, typically can be constructed to meet a more stringent (smaller) radius of curvature requirement. Conversely, larger facing units, such as wet cast concrete blocks, typically require a larger radius of curvature. Typical horizontal alignment criteria, including minimum radius of curvature, for conventional retaining walls are as follows:

### 16.3.4.1 CIP Gravity and Cantilever Walls

Gravity and cantilever retaining walls can be formed to a very tight radius of curvature to meet almost any project-specific horizontal (or vertical) wall alignment requirement.

### 16.3.4.2 Mechanically Stabilized Earth (MSE) Walls

The horizontal alignment requirement of MSE walls depends on several factors:

- Facing element dimensions (length, height and thickness)
- Facing panel layout of larger block facing units
- The selection/availability of special facing shapes to meet wall alignment requirements.

MSE retaining walls with small precast concrete panel facing (5-ft-wide units) are typically designed with a radius of curvature of 50 ft., or greater. This assumes a joint width of at least  $\frac{3}{4}$  in.

MSE retaining walls with dry cast concrete block facing can be formed to a tight radius and are typically designed assuming a radius of curvature of 10 ft., or greater.

### 16.3.4.3 Prefabricated Modular Walls

- Crib, bin, and gabion retaining walls are not well suited for alignments requiring a tight radius of curvature. *AASHTO Article 11.11.1 (AASHTO LRFD Bridge Design Specifications)* recommends design using a radius of curvature of at least 800 ft.—unless the horizontal curve can be substituted by a series of chords.
- Dry cast concrete block gravity retaining walls (single block thickness) can be formed to a tight radius and are typically designed assuming a radius of curvature of 10 ft., or greater.
- Wet cast concrete block gravity retaining walls arranged in a single row configuration are typically designed using a radius of curvature of 75–100 ft.
- Wet cast concrete block gravity retaining walls, more than one block in thickness, should be designed with a radius of curvature at least 800 ft.

### 16.3.5 Tiered or Superimposed Walls

A tiered or superimposed retaining wall consists of a lower tier retaining wall that supports the surcharge or load from an upper wall.

Tiered or superimposed retaining wall stability analysis and design shall consider the effects of the loads from the upper tier wall (including seismic loads) on the lower retaining wall. The internal, external, compound, and overall stability of the lower tier wall, including foundation settlement and wall deformation, shall be evaluated for these additional loads.

Analysis of the combined tiered wall system shall include investigating internal, compound, and overall failure surfaces through walls; foundation soils; backfill materials; embankments; and the ground surface between, above, and/or below the tiered retaining walls. Perform overall stability analysis using a state-of-the-practice slope stability computer program, such as the most current versions of Slope/W® (Geo-Slope International), Slide® (Rocscience, Inc.), and ReSSA® (ADAMA Engineering, Inc.). Overall stability analysis of tiered wall systems shall be in accordance with the requirements of AASHTO Article 11.6.2.3.

Design guidance for tiered MSE walls is provided in [Section 16.6.13](#).

### 16.3.6 Back-to-Back Walls

Design guidance for back-to-back MSE walls is provided in [Section 16.6.14](#). See the sections on specific wall types for further guidance on designing for back-to-back walls.

### 16.3.7 Wall Bench

AASHTO Article 11.10.2.2 requires a horizontal bench with a minimum width of 4.0 ft. in front of MSE walls founded on slopes. Where practical, a 4.0-ft-wide bench should be provided at the base of all retaining walls to provide access for inspection, maintenance, and/or repair. The



bench shall be 1v:6h, or flatter, and sloped to direct surface water to properly designed water collection facilities.

### 16.3.8 Wall Back Slope

Retaining wall back slopes shall be designed at 1v:2h (or flatter) unless a steeper back slope can be justified based on a project-specific geotechnical investigation and design.

### 16.3.9 Wall Stability

Design retaining walls for internal stability, external stability (sliding, bearing resistance, and settlement), overall (global) stability, and compound stability in accordance with the *AASHTO LRFD Bridge Design Specifications* and the *ODOT GDM*.

Overall and compound wall stability shall be evaluated using conventional limit equilibrium methods, and analyses shall be performed using a state-of-the-practice slope stability computer program such as the most current versions of Slope/W<sup>®</sup> (Geo-Slope International), Slide<sup>®</sup> (Rocscience, Inc.), and ReSSA<sup>®</sup> (ADAMA Engineering, Inc.).

Compound failure plane passing through the reinforced mass is not generally critical for simple, non-tiered MSE walls with rectangular geometry, with uniform reinforcement spacing and length, and without significant surcharge. Compound failures must be considered for complex situations such as changes in reinforced soil types or reinforcement lengths, high surcharge loads such as from sloping backfill or spread footing abutments, sloping faced structures, a slope at the toe of the wall, or tiered walls. (See AASHTO LRFD Article 11.10.1, its commentary, and AASHTO Figure 11.10.2-1)

Overall stability analysis shall investigate all potential failure surfaces passing behind and under the wall. Compound stability analysis shall investigate all potential failure surfaces that pass partially behind, under, or through the wall.

The overall stability of temporary cut slopes to facilitate retaining wall construction shall be evaluated in accordance with the requirements of [Section 16.3.26](#).

Overall and compound wall stability shall be evaluated at the Strength and Extreme limit states in accordance with AASHTO LRFD Section 11.

### 16.3.10 Lateral Earth Pressures

Active, at-rest, and passive lateral earth pressures for retaining wall design shall be calculated based on project-specific geotechnical data such as the subsurface profile, water head/groundwater levels, geotechnical soil properties (based on project-specific lab data), backslope/foreslope profiles, and soil-wall movement considerations as discussed below. Calculate lateral earth pressures on walls in accordance with AASHTO Article 3.11.

If live loads, including traffic, compaction, or construction equipment, or other surcharge loads can occur within a horizontal distance behind the top of a wall equal to one-half of the wall

height, the design lateral load should be increased to account for the additional lateral earth pressure that will act on the wall.

The lateral active earth pressure thrust on retaining walls which stabilize landslides (used to calculate external stability), shall be estimated from conventional limit equilibrium analysis using a state-of-the-practice slope stability computer program such as the most current versions of Slope/W® (Geo-Slope International) and Slide® (Rocscience, Inc.).

### **16.3.10.1 Active Earth Pressure**

Calculate active earth pressures on walls based on Coulomb or Rankine theories in accordance with AASHTO Article 3.11.5.3. Active earth pressures acting behind a retaining wall will depend on the ability of the wall to rotate and/or translate laterally (see AASHTO Article 3.11.1). An active earth pressure coefficient is appropriate when the top of the retaining wall can displace laterally at least  $0.001 \cdot H$  (dense sand backfill) to  $0.004 \cdot H$  (loose sand backfill) in accordance with AASHTO Table C3.11.1-1 where H is the height of the wall. Active lateral earth pressures on retaining walls shall be increased to include the effects of a sloping backfill in accordance with AASHTO Article 3.11.5.3.

The lateral active earth pressure thrust on retaining walls with a broken backslope, point load(s) or surcharge(s), groundwater effects, and/or with a non-uniform soil (backfill) profile, may be calculated using conventional limit equilibrium analysis using a state-of-the-practice slope stability computer program such as the most current versions of Slope/W® (Geo-Slope International) and Slide® (Rocscience, Inc.), or the Culmann or Trial Wedge methods such as presented in *Soil Mechanics in Engineering Practice* (Terzaghi and Peck, 1967) and NAVFAC DM-7.01 and DM-7.02 (U.S. Navy, 1986).

### **16.3.10.2 At-Rest Earth Pressure**

The at-rest earth pressure coefficient shall be used to calculate the lateral earth pressure for non-yielding retaining walls restrained from rotation and/or lateral translation in accordance with AASHTO Article C3.11.1. Non-yielding walls include, for example, integral abutment walls, wall corners, cut-and-cover tunnel walls, and braced walls or walls that are cross-braced to another wall or structure. Where bridge wingwalls join the bridge abutment, at-rest earth pressures should also be used.

### **16.3.10.3 Passive Earth Pressure**

Calculate passive earth pressures on walls based on Log Spiral and Trial Wedge theories in accordance with AASHTO Article 3.11.5.4. Calculate the lateral passive earth pressure thrust against walls adjacent to a broken back foreslope, point load(s) or surcharge(s), and/or with a non-uniform soil profile using the Culmann or Trial Wedge methods such as presented in *Soil Mechanics in Engineering Practice* (Terzaghi and Peck, 1967) or NAVFAC DM-7.01 and DM-7.02 (U.S. Navy, 1986).

When the Trial Wedge method is used to calculate the passive earth pressure thrust, the wall interface friction angle shall not be greater than 50 percent of the peak soil friction angle in accordance with AASHTO Article 3.11.5.4.

Neglect any contribution from passive earth pressure in stability calculations unless the base of the wall extends below the depth to which foundation soil or rock could be weakened or removed by freeze-thaw, shrink-swell, scour, erosion, construction excavation, or any other means. In wall stability calculations, only the embedment below this depth, known as the effective embedment depth, shall be considered when calculating the passive earth pressure resistance. This is in accordance with AASHTO Article 11.6.3.5.

Lateral wall footing displacements of approximately  $0.01 \cdot H$  (dense sand) to  $0.04 \cdot H$  (loose sand) and  $0.02 \cdot H$  (low plasticity silt) to  $0.05 \cdot H$  (high plasticity clay) are required to mobilize the maximum passive earth pressure resistance, where  $H$  is the effective embedment depth below foundation soils that could be weakened or removed as defined above. This is in accordance with AASHTO Article C3.11.1. Passive earth pressure resistance assumed in wall stability analysis shall be reduced or neglected, unless the wall footing has been designed to translate the minimum distances provided in AASHTO Table C3.11.1-1.

### **16.3.11 Compaction Loads**

Compaction equipment operated behind non-deflecting (restrained) semi-gravity cantilever and rigid gravity retaining walls can cause lateral earth pressures acting on the wall to exceed at-rest lateral earth pressures. The closer the compaction equipment operates to the wall, and the larger the total (static plus dynamic) compaction force, the higher will be the compaction induced lateral earth pressures on the wall.

[Figure 16-4](#) shows a lateral earth pressure diagram that includes the combined effects of residual lateral earth pressures from compaction and at-rest lateral earth pressures on non-deflecting semi-gravity (cantilever) and rigid gravity retaining walls.

Residual lateral earth pressure from compaction need not be considered in external stability design if walls can deflect sufficiently to develop active earth pressures in accordance with [Section 16.3.10.1](#) - but should be considered for internal stability (structural) design since residual lateral earth pressures can cause overstress in structural elements before sufficient deflection associated with the active state occurs.

Consider the lateral earth pressures from a compacted backfill to be “EH” loads, and use the corresponding load factors.

Figure 16-4 Unfactored Static Lateral Earth Pressure with Residual Horizontal Compaction Pressures on Non-deflecting CIP Semi-Gravity and Rigid Gravity Retaining Walls.

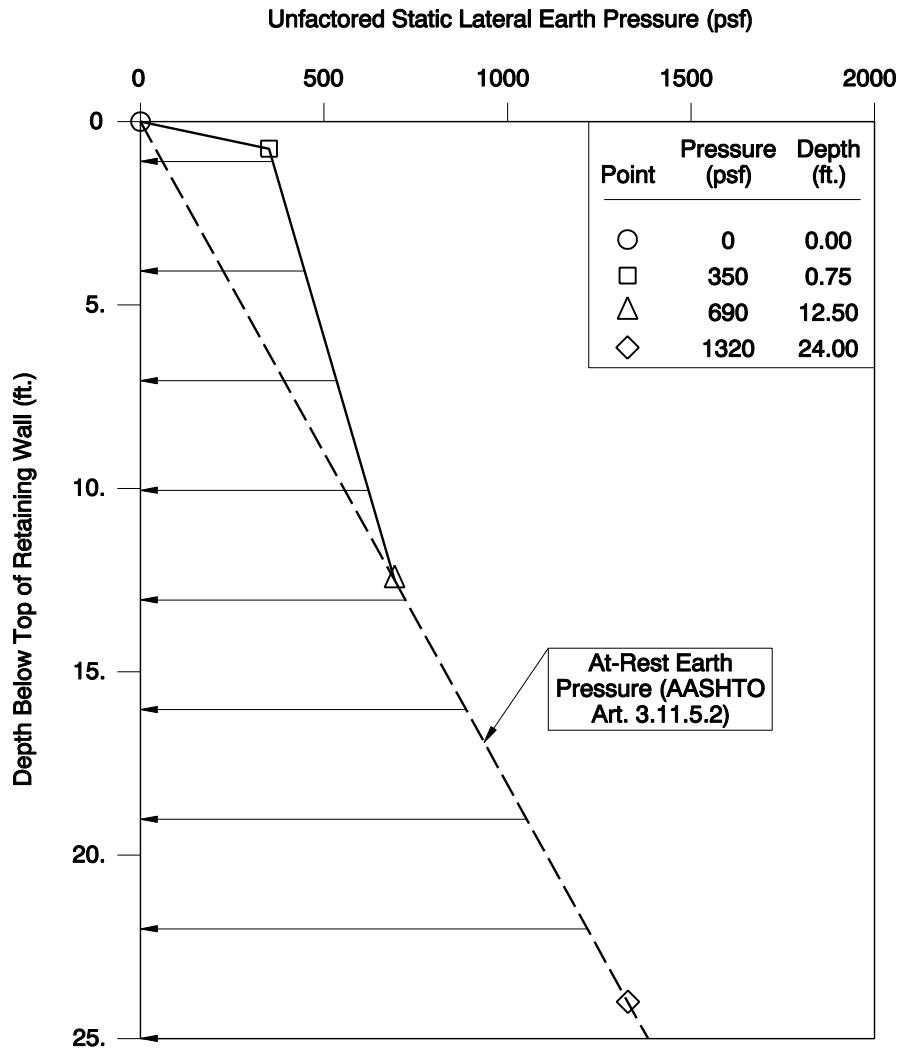

**Notes:**

1. Compaction-induced lateral earth pressures estimated using Peck and Mesri (1987) method. This method was developed for relatively stiff CIP Semi-Gravity (Cantilever) and Rigid Gravity retaining walls.
2. Recommended unfactored static lateral earth pressures assume backfill peak soil friction angle of 34°, compacted backfill unit wt. of 125 pcf, and backfill compaction with hand-operated, vibratory roller (combined operational weight plus dynamic or centrifugal force not greater than 5,000 lbs). Additionally, it was assumed this hand-operated compaction equipment is operated within a distance of 0.2 ft (2 in) from the back of the retaining wall.
3. Recommended unfactored static lateral earth pressures shall be considered "EH" loads to be used with the applicable load factors.

### 16.3.12 Construction Surcharge Loads

Design retaining walls for increased lateral earth pressures due to typical construction surcharge loads in accordance with AASHTO Article 3.11.6 and the *ODOT GDM*.

Retaining walls shall be designed for construction surcharge loads, including construction equipment operation and storage loads behind the wall if the ground surface behind the wall is sloped at 1v:4h or flatter. Apply a uniform live load surcharge of at least 250 pounds per square foot (psf) along the ground surface behind the wall to represent typical construction loads. Additionally, design walls for lateral earth pressures resulting from any anticipated special construction loading condition, such as the operation of a large or heavily loaded crane, materials storage, or soil stockpile near the top of the wall.

Design shall assume that seismic loads do not act concurrently with construction surcharge loads.

### 16.3.13 Seismic Design

Seismic design of retaining walls shall be in accordance with the requirements in *Section 11 Walls, Abutments, and Piers* of the *AASHTO LRFD Bridge Design Specifications*. See [Chapter 7](#) for the seismic design performance objectives for Bridge retaining walls and Highway retaining walls.

Unless stated otherwise, seismic design of retaining walls shall assume a vertical acceleration coefficient ( $k_v$ ) = 0.0.

For Extreme Event I limit state, the load factor for live load ( $\gamma_{EQ}$ ) shall be equal to 0.5.

Where retaining walls cannot be fully drained, lateral pressure force effects due to water pressure head shall be added to seismic lateral earth pressures calculated in accordance with *AASHTO LRFD* and the *ODOT GDM*.

When the M-O method is not applicable and external seismic lateral loads are calculated using the GLE method, provide the seismic coefficient ( $k_h$ ) and the external seismic lateral thrust ( $P_{AE}$ ) in the project special provisions.

See the sections on specific wall types for further guidance on designing for seismic effects.

### 16.3.14 Minimum Footing Embedment

Retaining wall footing embedment shall satisfy the minimum embedment criteria in *AASHTO LRFD Section 10 Foundations and Section 11 Walls, Abutments, and Piers*. The final footing embedment depth shall be based on the required geotechnical bearing resistance, wall settlement limitations, and all internal, external, and overall (global) wall stability requirements in *AASHTO LRFD*. Additionally, **bridge retaining wall** footing embedment shall meet requirements in the *ODOT BDM*.

The minimum wall footing embedment depth shall be established below the maximum depth foundation soils (or rock) could be weakened or removed by freeze-thaw, shrink-swell, scour,

erosion, construction-excavation, or any other means. The potential scour elevation shall be established in accordance with *AASHTO LRFD*, the *ODOT BDDM*, and the *ODOT Hydraulics Manual*.

### **16.3.15 Foundation Settlement Serviceability Criteria**

Retaining wall structures shall be designed for the effects of the total and differential foundation settlements at the Service I limit state, in accordance with *AASHTO LRFD* and the *ODOT GDM*. Maximum foundation settlements shall be calculated along longitudinal and transverse lines through retaining walls. In addition to the requirements for serviceability in *AASHTO LRFD*, Tables 16-1 and 16-2 shall be used to establish acceptable settlement criteria (includes settlement that occurs during and after wall construction). However, settlement criteria more stringent than that indicated in Tables 16-1 and 16-2 may be applicable based on project specific requirements for retaining walls, including aesthetics.

Maximum tolerable retaining wall total and differential foundation settlements are controlled largely by the potential for cosmetic and/or structural damage to facing elements, copings, barrier, guardrail, signs, pavements, utilities, structure foundations, and other highway construction supported on or near the retaining wall.

**Table 16-1 Foundation Total Settlement Criteria**

Wall Type	Maximum Total Settlement, Inch.	
	Criteria A <sup>1</sup>	Criteria B <sup>2</sup>
MSE walls with cast-in-place facing or large precast concrete panel facing (panel front face area ≥30 ft <sup>2</sup> )	1	2
Crib walls (precast concrete)	1	2
CIP concrete gravity and semi-gravity cantilever walls	1	2
Non-gravity cantilever walls and anchored walls	1	2
Bin or gabion walls	2	4
MSE walls with small precast concrete panel facing (panel front face area <30 ft <sup>2</sup> )	2	4
MSE walls with dry cast concrete block facing units	2	4
MSE Walls with geotextile/welded-wire/gabion basket facing	4	12
MSE walls with structural facing installed during a second construction stage after MSE wall settlement is complete (MSE retaining wall system with two-stage facing)	4	12

Table 16-2 provides maximum foundation differential settlements for selected retaining wall types:

<sup>1</sup> Criteria A – Maximum settlement within accepted tolerance – proceed with structure design and construction.

<sup>2</sup> Criteria B – Maximum settlement exceeds accepted tolerance – ensure structure can tolerate settlement.

**Table 16-2 Foundation Differential Settlement Criteria**

Wall Type	Maximum Differential Settlement Over 100 Feet, Inch	
	Criteria A <sup>1</sup>	Criteria B <sup>2</sup>
CIP concrete gravity and semi-gravity cantilever walls	¾	2
MSE walls with cast-in-place facing or full-height precast facing panels	¾	2
Crib walls (precast concrete)	¾	2
Wet and dry cast concrete block gravity retaining walls	1½	3
Bin (precast concrete or metal)	1½	3
MSE walls with large precast concrete panel facing (panel front face area ≥30 ft <sup>2</sup> )	1½	3
MSE walls with small precast concrete panel facing (panel front face area <30ft <sup>2</sup> )	1½	3
MSE walls with dry cast concrete block facing units	1½	3
MSE Walls with geotextile/welded-wire/gabion basket facing	3	9
Gabion	3	9

Select a retaining wall type that meets both the total and differential foundation settlement tolerance criteria provided above. If the selected wall type does not meet the settlement tolerance criteria, then select a more settlement-tolerant wall type. For example, an MSE wall with dry cast concrete block facing is more tolerant of foundation settlement than an MSE wall with large precast concrete facing.

When project requirements dictate the use of a specific retaining wall type, irrespective of foundation settlement tolerance considerations, then the following options should be considered for accommodating or reducing excessive foundation settlements:

- Use of a MSE wall system with two-stage facing designed in accordance with [Section 16.6.11](#). A relatively flexible geotextile or welded-wire face MSE wall (first-stage wall) is built to near final grade and a surcharge used as needed to reduce long-term foundation settlements. MSE wall stability and settlement is carefully evaluated for all stages of construction in accordance with the *ODOT GDM*. After monitoring indicates the time-rate of foundation settlement has been adequately reduced, settlement-sensitive, cast-in-place or precast wall facing elements, coping and appurtenances are installed for the completed (second-stage) MSE wall.
- Partial to complete removal of the compressible soil layer(s) and replacement with granular structure backfill meeting the requirements of 00510.
- Ground improvement techniques to reduce foundation settlements. [Chapter 12](#) in the *ODOT GDM* provides guidance for selection of an appropriate ground improvement method and preliminary ground improvement design criteria.
- Use of lightweight retaining wall backfill to reduce the wall surcharge.
- Deep foundation support of the retaining wall.

- Where longitudinal differential settlement in excess of 3 inches is anticipated, consider use of full-height, slip joints along MSE walls with precast concrete panel facing.

### 16.3.16 Groundwater Monitoring

Install at least one piezometer at each retaining wall site to monitor fluctuations in groundwater elevations. This data is required for the following reasons:

- Seismic hazard assessment and mitigation design—liquefaction/lateral spread;
- Foundation design—bearing resistance and settlement;
- Design lateral earth pressure(s);
- Internal, external, compound and global (overall) stability analysis;
- Seepage analysis for design of retaining wall subdrainage system;
- Evaluate construction dewatering requirements; and
- Analysis and design of temporary excavation (backcut) and long-term slope stability.

### 16.3.17 Seismic Hazards

The most common causes of poor seismic performance of properly constructed retaining walls are foundation failures and severe strength loss in the wall backfill. The geotechnical designer shall first focus on evaluating the strength loss potential of earth materials comprising and surrounding the retaining structure and its foundation, including assessment of liquefaction, lateral spread, and other seismic hazards at the wall site in accordance with *AASHTO LRFD* and *ODOT GDM* [Chapter 7](#), [Chapter 15](#), and [Chapter 16](#). Analysis and design for assessment and mitigation of seismic hazards shall be in accordance with *AASHTO LRFD* and the *ODOT GDM*.

### 16.3.18 Wall Subsurface Drainage

Retaining walls shall include an adequate wall subsurface drainage system designed to resist the critical combination of water pressures, seepage forces, and backfill lateral earth pressure(s) in accordance with *AASHTO LRFD* and the *ODOT GDM*. **If drainage is not provided to completely drain the retained soil, then design of the wall should include hydrostatic pressure from water in the retained backfill.**

Inadequate wall subdrainage can cause premature deterioration, reduced stability, and failure of a retaining wall. A properly designed wall subdrainage system is required to control potentially damaging hydrostatic pressures and seepage forces behind and around a wall. Redundancy in the subdrainage system is required where subsurface drainage is critical for maintaining retaining wall stability. Properly designed and constructed wall subdrainage systems provide the following benefits:

- Improve appearance and reduce deterioration rates of retaining wall components subject to wetness;
- Protect MSE wall steel and geosynthetic reinforcements from exposure to aggressive subsurface and surface water;
- Increase density and strength of wall backfill materials;



- Increase wall backfill resistance to liquefaction and loss of strength under seismic loads;
- Increase wall foreslope, backslope, and global stability; and
- Increase density and strength of wall foundation soils.

The sizing of subdrainage system components (i.e., permeable layers, collector/outlet pipes, and drainage ditches) shall be based on project-specific calculated seepage volumes. Design the selected subdrainage system using SEEP/W 2-D finite element seepage analysis program or calculation methods such as those presented in *Soil Mechanics NAVFAC DM-7.01* (U.S. Navy, 1986), *Soil Mechanics in Engineering Practice* (Terzaghi and Peck, 1967), or *Seepage, Drainage, and Flow Nets, 3rd Edition* (H. R. Cedergren, 1989).

Provide retaining wall drainage for conventional cast-in-place concrete (CIP), semi-gravity (cantilever) and gravity retaining walls in accordance with AASHTO Article 11.6.6. Drainage for CIP cantilever and gravity retaining walls typically consists of a positive-flow, perforated collector drainpipe installed in a permeable layer along the wall heel. The collector pipe is typically connected to a solid outlet pipe at a sag (or the low end) of the collector pipe. The solid pipe discharges water to an approved, maintained drainage ditch or storm drain system. Provide clean outs at the high end of the collector pipe, or at other suitable locations. A drainage geotextile shall encapsulate the collector pipe and surrounding permeable layer to prevent the migration of surrounding soils into the subdrainage system that could result in clogging of the collector pipe and/or permeable layer(s) and reduced wall subdrainage capacity.

Drainage for soldier pile/lagging, sheet pile, soil nail, and other non-gravity cantilever and anchored retaining wall systems shall meet all the requirements in AASHTO Article 11.8.8 and Chapter 15.

Drainage for permanent soldier pile/lagging or soil nail walls typically includes vertical strip drains (prefabricated composite drainage material) to transport drainage to weep holes and/or drainage collector pipes located near the base of the wall. The collector pipe is connected to a solid outlet pipe that should discharge into an approved drainage ditch or storm drain system. Provide properly located clean outs for the collector and outlet pipes.

Specify perforated collector and solid subsurface drain pipes at least 6in diameter to allow for periodic pipe flushing and cleaning, irrespective of discharge capacity requirements. Pipe discharge and clean out locations shall be readily accessible to maintenance personnel. Provide metal screens or secure caps at pipe ends to prevent rodent entry.

Porewater pressures from static groundwater levels shall be added to effective horizontal earth pressures to determine total lateral pressures on retaining walls in accordance with AASHTO Article C3.11.3. The effects of water pressures on retaining walls such as the potential for piping instability, a “quick condition”, and/or loss of soil strength from seepage forces can be approximated using SEEP/W 2-D finite element seepage analysis program or calculation procedures in *Soil Mechanics NAVFAC DM-7.01* (U.S. Navy, 1986), *Soil Mechanics in Engineering Practice* (Terzaghi and Peck, 1967), *Soil Mechanics* (Lambe and Whitman, 1969), and/or *Seepage, Drainage, and Flow Nets, 3rd Edition* (H. R. Cedergren, 1989).

## 16.3.19 Underground Utilities

Mechanically stabilized earth (MSE) walls, soil nail or any type of anchored retaining wall should be avoided when existing or future (planned) underground utilities are located within or below the reinforced backfill or anchorage zone behind walls. Utilities encapsulated within the reinforced or anchored zone will not be accessible for replacement or maintenance. Removal (cutting) of ground support elements for new utility construction could result in wall failure. Soil nail and anchor installation could damage in-place utilities.

## 16.3.20 Design Life

The minimum design life for Highway Retaining Walls shall be 75 years. The design life of Bridge Retaining Walls shall be consistent with the structures they stabilize, but not less than 75 years.

## 16.3.21 Corrosion Protection

Corrosion protection consistent with the intended design life of the retaining wall is required for all walls based on the criteria in AASHTO Articles 11.10.6.4.2a or 11.10.6.4.2b. The level of effort to prevent corrosion of metallic components in retaining wall systems depends mainly on the potential for exposure to a corrosive environment. In Oregon, retaining wall sites with aggressive corrosive environments are typically snow/ice removal zones or marine environment zones as described below.

### 16.3.21.1 Snow/Ice Removal Zones

Snow/ice removal zones are sections of highway where seasonal snow and ice removal requires the use of de-icing materials containing aggressive compounds that may meet retaining walls. Provide appropriate corrosion protection consistent with the recommendations in [Section 16.3.21.2](#) and the design guidance in [Section 16.3.21.3](#).

### 16.3.21.2 Marine Environment Zones

Marine environment zones are sections of highway in close proximity to the ocean, a saltwater bay, river or slough, where airborne saltwater spray or saline precipitation could come in contact with the wall. In accordance with 00560.29(b)(1), "On projects within 25 miles of the Pacific ocean, all high strength fasteners shall be galvanized in accordance with 02560.40", and "In areas visible to the public, clean and prepare fasteners and coat according to Section 00594". For the purposes of determining when special corrosion protection is required, a Marine Environment is defined as any of the following:

- A location in direct contact with ocean water, salt water in a bay, or salt water in a river or stream at high tide;
- A location within ½ mile of the ocean or a salt water bay with no physical barrier such as hills and forests to prevent strong winds from carrying salt spray generated by breaking waves; or

- A location crossing salt water in a river or stream where there are no barriers such as hills and forests to prevent strong winds from generating breaking waves.

Provide the following minimum protection system for concrete retaining walls and concrete components of retaining walls in a Marine Environment:

- Minimum 2 in. cover on all cast-in-place members.
- HPC (High-Performance Concrete), also known as Microsilica, to be used for all precast and cast-in-place concrete elements.

For retaining walls in a Marine Environment, consider using retaining wall systems that do not use steel soil reinforcements, components, and connections, or provide additional corrosion protection for steel in order to achieve the specified design life. Corrosion protection measures shall consider the following:

- Increase concrete cover;
- Isolate dissimilar metals;
- Use increased corrosion rates for design and increase sacrificial steel thickness accordingly;
- Prevent entry of corrosive runoff into the reinforced backfill;
- Use stainless steel;
- Use cathodic protection;
- Encapsulate steel components; and
- Concrete sealers.

### 16.3.21.3 Corrosion Protection Design Guidance

AASHTO Articles 11.8.7 (Non-Gravity Cantilever walls), 11.9.7 (Anchored walls), and 11.10.2.3.3 (MSE walls) provide design guidance for corrosion protection.

Subsequent sections of Chapter 15 provide selection and design guidance for corrosion protection of specific retaining wall types.

Corrosion protection should be reviewed with the Corrosion Specialist on a project-by-project basis.

## 16.3.22 Railing

### 16.3.22.1 Traffic Barrier and Railing

Design and selection of retaining wall roadside safety features are presented in the [ODOT Highway Design Manual](#), [AASHTO Manual for Assessing Safety Hardware \(MASH\)](#), [AASHTO Roadside Design Guide](#), and [AASHTO LRFD Bridge Design Specifications](#).

Drop-offs at the top of retaining walls **require protection** with traffic railing (barrier) in accordance with the criteria in Section 4.6.2 of the [ODOT Highway Design Manual](#) (Current Edition). Additional requirements for traffic railing specific to MSE walls are presented in [Section 16.6.9](#).

A roadside retaining wall located within the clear zone is a crash hazard that warrants traffic protection with guardrail or concrete barrier in accordance with the [ODOT Highway Design Manual](#) Chapter 4 and [AASHTO Roadside Design Guide](#) Chapter 5. [AASHTO Roadside Design Guide](#) Figures 5-27 through 5-31 show the Zone of Intrusion for Test Level 2 through Test Level 4 barriers and rails. The Zone of Intrusion is the region measured above and behind the face of a barrier system where the impacting vehicle may extend during an impact. The barrier location design should accommodate this distance not only for traffic safety, but for protection of the retaining wall from damage and instability in the event of a crash.

Standard Drawing RD526 Concrete Barrier Buried in Backslope details the termination of a barrier length buried in backslope. RD526 is inappropriate for use as a standard drawing for using concrete barrier as a retaining wall without project specific design. Concrete barrier is not allowed as a permanent retaining wall without a design deviation and project-specific design meeting the requirements of this chapter. The design deviation request should include discussion of risk, options considered, and repair plan for damage from collision.

### 16.3.22.2 Pedestrian/Bicycle Railing

Criteria for determining the need and type (bridge rail or open handrail) of pedestrian or bicycle rail is presented in Section 13.4.7 of the [ODOT Highway Design Manual](#) (Current Edition).

### 16.3.22.3 Worker Fall Protection Railing

[Oregon OSHA Administrative Order 2-2017 Division 2, Subdivision D \(Walking Working Surfaces\)](#) (adopted 5/16/17, effective 11/1/17) requires that fall protection be provided for employees exposed to the possibility of falling from a location 4 feet or more above a lower level. Provide ODOT Standard Drawing RD770 Pedestrian Handrail or other fall protection guardrail systems in accordance with Walking Working Surfaces Section 1910.29 for design of retaining walls with exposed height of 4 feet or more.

## 16.3.23 Proprietary Minor Retaining Wall Systems

Proprietary minor retaining wall systems are defined in [Section 16.2](#).

Based on recent project experience use of proprietary minor retaining wall systems in project plans has resulted in excess over-design and project cost. Examples of this include minor cuts behind sidewalks to allow for ADA compliance, and utility poles. For minor retaining walls on ODOT projects a nonproprietary (fully detailed) design should be performed and investigated for use in the contract plans.

## 16.3.24 Nonproprietary Minor Retaining Wall Systems

Nonproprietary minor retaining wall systems are defined in [Section 16.2](#).

Design nonproprietary minor retaining wall systems in accordance with Chapter 15, except as follows:

- Nonproprietary Minor retaining wall systems shall be one of the following wall types:

- Cast-in-place concrete gravity and semi-gravity retaining wall systems;
- Dry cast concrete block prefabricated modular retaining wall systems;
- Wet cast concrete block prefabricated modular retaining wall systems; or
- Gabion prefabricated modular retaining wall systems.
- Walls shall include adequate subdrainage to maintain ground water levels below the bottom of wall and the wall backfill (show on control plans). The subdrainage system shall include a perforated drainage pipe (6-in. diameter PVC) installed near the heel of the retaining wall.
- The retaining wall shall be embedded according to the minimum embedment criteria in *AASHTO LRFD Section 10 Foundations and Section 11 Walls, Abutments, and Piers*.
- It is not required to obtain a structure number or calculation book number for minor retaining walls. This does not negate the QC/QA process or the requirement to sign and seal contract plans and specifications.
- The minor retaining wall should be designed by a competent qualified engineer.
- Passive pressure resistance shall be neglected when calculating sliding resistance of the wall.
- Calculate active lateral earth pressure coefficient ( $k_a$ ) for wall design using Coulomb earth pressure theory in accordance with AASHTO Article 3.11.5.3 and [Section 16.3.10](#).
- Seismic design is not required.
- A geotechnical investigation is not required.
- Assume foundation soil bearing resistance is adequate at all applicable limit state.
- Assume settlement is tolerable at all applicable limit states.
- Assume backfill soil friction angle ( $\phi$ ) = 34°.
- Assume backfill cohesion ( $c$ ) = 0 psf.
- Assume backfill moist unit weight ( $\gamma_{wet}$ ) = 125 pcf.
- Assume gravel leveling pad angle of internal friction = 34°.
- Assume no sliding stability failure within the foundation soil below the gravel-leveling pad.
- Assume only minor cut-and-fill grading for wall construction, as shown in [Figure 16-2](#), that will have no significant effect on overall (global) stability.
- On the project plans, label the wall as a “Minor Retaining Wall”.

### 16.3.25 Wall Backfill Testing and Design Properties

Retaining walls may be designed using a higher soil friction angle based on shear strength test measurements performed on representative backfill samples in lieu of using the lower-bound presumptive backfill strength parameters. Measure retaining wall backfill frictional strength by triaxial or direct shear testing methods, ASTM D4767 or AASHTO T236, respectively. Fabricate triaxial or direct shear test samples to within minus 4 percent to plus 2 percent of the optimum moisture content, and to 95 percent of the maximum density determined according to AASHTO T99 Standard Proctor Method A with coarse particle correction according to AASHTO T224. A design friction angle of greater than 40° shall not be used even if the measured friction angle is greater than 40°.

## 16.3.26 Temporary Shoring and Cut Slopes

### 16.3.26.1 General Considerations

Temporary shoring is defined as an earth retention and support system that is installed prior to or during excavation using top-down construction techniques. Temporary shoring provides lateral support of in-situ soils and limits lateral movement of soils supporting adjacent structures or facilities, such as bridge abutments, roadways, utilities, and railroads, such that these facilities are not damaged as a result of the lateral soil movements.

Temporary cut slopes are also considered shoring, and are included in the definition of Temporary Shoring for contractual purposes. Temporary shoring systems are defined as the following retaining wall system types listed in [Section 16.2.4.2](#):

Table 16-3 Temporary Shoring Systems

Retaining Wall System Type <sup>1</sup>	Retaining Wall System Name	Design Requirements (GDM Section or Special Manual Reference) <sup>2</sup>
5A	Soldier Pile/Lagging Walls	<a href="#">16.8.3</a>
5B	Sheet Pile Walls	<a href="#">16.8.4</a>
5C	Tangent Pile Wall	<a href="#">16.12</a>
5D	Secant Pile Wall	<a href="#">16.12</a>
5E	Slurry (Diaphragm Wall)	<a href="#">16.13</a>
5F	Micropile	FHWA-NHI-05-039
6A	Tie Back Soldier Pile Walls	<a href="#">16.9</a> \ <a href="#">16.10</a>
6B	Anchored Sheet Pile Walls	<a href="#">16.9</a> \ <a href="#">16.10</a>
7A	Soil Nail Walls	<a href="#">16.11</a>

**Notes:**

1. Retaining wall systems listed in [Section 16.2.4.2](#).
2. In case of conflict, design requirements in [Section 16.3.26](#) shall take precedence.

Trench boxes, sliding trench shields, jacked shores, shoring systems that are installed after excavation, and soldier pile, sheet pile, or similar shoring walls installed in front of a pre-excavated slope, are not allowed as shoring.

Unless otherwise noted in the contract plans and specifications, the contractor is responsible for internal and external stability design of temporary shoring. The Agency Professional of Record

(POR) may elect to design the temporary shoring in cases such as special construction loading conditions, where shoring provides support of critical adjacent structures or facilities, and/or where shoring is planned within railroad right-of-way, which typically requires railroad review prior to advertisement of the construction contract.

### **16.3.26.2 Geotechnical Investigation**

Geotechnical investigations for temporary shoring and temporary cut slopes shall be in accordance with GDM. Ideally, the explorations and laboratory testing completed for the design of the permanent infrastructure will be sufficient for design of temporary shoring systems by the Contractor. However, this is not always the case, and additional explorations and laboratory testing may be needed to complete the shoring design.

If shoring systems include a combination of soil or rock slopes above and/or below the shoring wall, the compound/global stability of the slope(s) above and below the wall shall be addressed in addition to the stability of the temporary shoring.

The scope of the geotechnical investigation for temporary shoring systems shall address any special conditions associated with temporary shoring, construction equipment with high static and/or dynamic loads, elevated hydrostatic/seepage forces from dewatering, and potential ground heave, instability, and/or internal erosion due to seepage gradients from dewatering.

### **16.3.26.3 Design Requirements**

Temporary shoring shall be designed in accordance with the requirements in Division I, Section 5 of the *AASHTO Standard Specifications for Highway Bridges*, 17<sup>th</sup> Edition (2002) for allowable stress or load factor design, or the *AASHTO LRFD Bridge Design Specifications* (current Edition) including current interims for load and resistance factor design. The shoring design shall also be in compliance with the **ODOT** BDDM and the **ODOT** GDM. In case of conflict or discrepancy between these design specifications and manuals, the **ODOT** GDM shall govern. Temporary shoring design must address all aspects of internal and external stability, including assessment of overturning, sliding, bearing resistance, settlement and compound/global stability. The stability of temporary cut slopes or excavations required for shoring installation shall be assessed and stabilized as needed. Temporary cut slopes, with or without temporary shoring, shall be designed in accordance with the **ODOT** GDM.

Temporary shoring systems maybe designed and constructed utilizing all structural steel or in combination of different materials. All structural steel members can be designed with *AASHTO Standard Specifications for Highway Bridges*, 17<sup>th</sup> Edition (2002) or the most current *Steel Construction Manual* (AISC) for allowable stress design in sizing structural steel members.

FHWA retaining wall design manuals referenced in the GDM (based on allowable stress design) may be used if an approved AASHTO LRFD methodology is not available. The *USS Steel Sheet Piling Design Manuals* (United States Steel, 1984) may be used for shoring walls that do not support other structures and are 15ft or less in height. Whichever design methodology is used for temporary shoring, the design input parameters, including assumed external loads,

geotechnical soil/rock properties, and wall material properties, must be clearly stated in the required submittal.

If the temporary shoring design life is 3 years or less, shoring need not be designed for seismic loading. Sufficient corrosion protection should be provided in consideration of the design life of the shoring.

Temporary shoring shall be designed for actual construction-related loads, which can be significantly higher than those assumed in design of permanent structures, such as operation of large cranes or other large equipment near the shoring system. In this case, the construction equipment loads shall still be considered to be a live load, unless the dynamic and transient forces caused by use of the construction equipment can be separated from the construction equipment weight as a dead load, in which case, only the dynamic or transient loads carried or created by the use of the construction equipment need to be considered live load. As a minimum, the shoring systems shall be designed for a live load surcharge of 250 psf to address routine construction equipment traffic above the shoring system.

In accordance with the *AASHTO LRFD* requirements, compound \ global stability analysis shall assume a resistance factor of 0.65, or a factor of safety of 1.5, for temporary shoring systems and/or cut slopes which provide a critical support function, such as support of a structure such as a bridge, retaining wall, sound wall, or building - or any highway embankment which supports an important section of highway. Use a resistance factor of 0.75, or a factor of safety of 1.3, for temporary shoring or cut slopes systems, which do not provide a critical support function.

### **16.3.26.4 Performance Requirements**

Temporary shoring and cut slopes shall be designed to prevent excessive deformation that could result in damage to bridges, buildings, pavements, and other adjacent structures and facilities. The shoring design shall include the determination of actual threshold limits of differential foundation settlement and/or lateral movement that could result in structural damage to adjacent construction. Typical highway structures, including bridge spread footings and CIP concrete retaining walls, can experience unacceptable cracking, displacement, and/or structural damage at a threshold differential settlement of between 1 and 2 inches over a distance of 50 feet. If analysis indicates differential foundation settlement and/or lateral movement will exceed permissible magnitudes, remedial works will be redesigned to prevent damage.

### **16.3.26.5 OSHA Excavation Safety Requirements**

Temporary cut slopes are used extensively to accelerate construction schedules and minimize costs. Since the contractor has control of construction operations, the contractor is responsible for the stability of cut slopes, as well as the safety of the excavations, unless otherwise specifically stated in the contract documents. Because excavations are recognized as one of the most hazardous construction operations, temporary cut slopes must be designed to meet Federal and State regulations in addition to the requirements stated in the **ODOT** GDM. Federal



regulations regarding temporary cut slopes are presented in *Code of Federal Regulations (CFR)* Part 29, Sections 1926.

### **16.3.26.6 Submittal Requirements**

When performing a geotechnical review of a contractor shoring and excavation submittal, the following items should be specifically evaluated:

1. *Shoring System Geometry:*
  - Has the shoring geometry been correctly developed and all pertinent dimensions shown?
  - Are the slope angle and height above and below the shoring wall shown?
  - Are correct locations of adjacent structures shown?
2. *Performance Objectives for the Shoring System:*
  - Is the anticipated design life of the shoring system identified?
  - Are objectives regarding what the shoring system is to protect, and remedial works to protect it, clearly identified and detailed?
  - Does the shoring system stay within the constraints at the site, such as the right of way limits and boundaries for temporary easements?
3. *Subsurface Conditions:*
  - Is the design soil/rock profile consistent with the subsurface geotechnical data provided in the contract boring logs?
  - Did the contractor/shoring designer obtain the additional subsurface data needed to meet the geotechnical exploration requirements for slopes and walls as identified in the GDM?
  - Was justification for the soil, rock, and other material properties used for the design of the shoring system provided - and is that justification, and the final values selected, consistent with GDM and the subsurface field and lab data obtained at the shoring site?
  - Were ground water conditions adequately assessed by comparison of field measurements with the site stratigraphy to identify zones of ground water, aquitards and aquicludes, artesian conditions, and perched zones of ground water?
4. *Shoring System Loading:*
  - Have the anticipated loads on the shoring system been correctly identified, considering all applicable limit states?
  - If construction or public traffic is near or directly above shoring system, has a minimum traffic live load surcharge of 250 psf been applied?
  - If larger construction equipment such as cranes will be placed above the shoring system, have the loads from that equipment been correctly determined and included in the shoring system design?
  - If the shoring system is to be in place longer than three years, have loads from extreme events such as seismic and appropriate design life scour been included in the shoring system design?
5. *Shoring System Design:*

- Have the correct design procedures been used (i.e., the GDM and referenced design specifications and manuals)?
  - Have all appropriate limit states been considered (e.g., global stability of slopes above and below wall, global stability of wall/slope combination, internal wall stability, external wall stability, bearing capacity, settlement, lateral deformation, piping or heaving due to differential water head)?
  - Have the effects of any construction activities adjacent to the shoring system on the stability/performance of the shoring system been addressed in the shoring design (e.g., excavation or soil disturbance in front of the wall or slope, excavation dewatering, vibrations and soil loosening due to soil modification/improvement activities)?
6. *Shoring System Monitoring/Testing:*
- Inadequate performance of critical shoring could result in damage to bridges, buildings, pavements, and other adjacent structures and facilities. If critical shoring is planned, is a monitoring/testing plan, such as installation/monitoring of survey points and/or tension tests of tiebacks, provided to verify adequate performance of the shoring system throughout the design life of the system?
  - Have appropriate displacements or other performance triggers been provided that are consistent with the performance objectives of the shoring system?
7. *Shoring System Removal:*
- Have any elements of the shoring system to be left in place after construction of the permanent structure is complete been identified?
  - Has a plan been provided regarding how to prevent the remaining elements of the shoring system from interfering with future construction and performance of the finished work (e.g., will the shoring system impede flow of ground water, create a hard spot, and/or create a surface of weakness regarding slope stability)?

## 16.3.27 Temporary Retaining Walls

### 16.3.27.1 General Considerations

Temporary retaining walls are defined as any of the following retaining wall system types listed in [Section 16.2.4.2](#):

**Table 16-4 Temporary Retaining Walls**

Retaining Wall System Type <sup>1</sup>	Retaining Wall System Name	Design Requirements (GDM Section) <sup>2</sup>
Retaining Wall System Types Commonly Used as Temporary Retaining Walls		
2B	Precast Concrete Bin - Prefabricated Modular	<a href="#">16.7.1</a>

Retaining Wall System Type <sup>1</sup>	Retaining Wall System Name	Design Requirements (GDM Section) <sup>2</sup>
2C	Metal Bin - Prefabricated Modular	<a href="#">16.7.1</a>
2D	Gabion - Prefabricated Modular	<a href="#">16.7.3</a>
2F	Wet Cast Concrete Block - Prefabricated Modular	<a href="#">16.7.5</a>
3E	MSE - Welded Wire Facing	<a href="#">16.6</a>
3F	MSE - Gabion Facing	<a href="#">16.6, 16.7.3</a>
8A	MSE - Temporary Geotextile Reinforced Wrapped Facing	<a href="#">16.6.16</a>
Retaining Wall System Types Less Frequently Used as Temporary Retaining Walls		
1A	CIP Concrete Rigid Gravity	<a href="#">16.4</a>
2A	Precast Concrete Crib Prefabricated Modular	<a href="#">16.7.2</a>
2E	Dry Cast Concrete Block Prefabricated Modular	<a href="#">16.7.4</a>
3A	MSE - Dry Cast Concrete Block Facing	<a href="#">16.6</a>
3B	MSE - Wet Cast Concrete Block Facing	<a href="#">16.6</a>
3C	MSE - Precast Concrete Small Panel Facing	<a href="#">16.6</a>
3D	MSE - Precast Concrete Large Panel Facing	<a href="#">16.6</a>
3G	MSE - Two-Stage Facing	<a href="#">16.6</a>
3H	MSE - Precast Concrete "Full Height Panel" Facing	<a href="#">16.6</a>
3K	GRS-IBS Abutment with Dry Cast Concrete Block Facing	<a href="#">16.6.15</a>

Retaining Wall System Type <sup>1</sup>	Retaining Wall System Name	Design Requirements (GDM Section) <sup>2</sup>
4A	CIP Concrete Cantilever Semi-Gravity	<a href="#">16.5</a>

**Notes:**

1. Retaining wall systems listed in [Section 16.2.4.2](#).
2. In case of conflict, design requirements in [Section 16.3.27](#) shall take precedence.

Temporary retaining walls are used in construction applications; typically to provide grade separation for approach fills or embankments required for temporary detours. **Temporary retaining walls shall have a maximum design life 3 years and be in service for 3 years or less.**

Unless otherwise noted in the contract plans and specifications, the contractor is responsible for design of temporary retaining walls. The Professional of Record (POR) may elect to design temporary retaining walls in cases of special construction loading conditions or when the wall provides critical structure support - such as temporary detour bridge abutment foundation.

### **16.3.27.2 Design Requirements**

Temporary retaining walls shall be designed in accordance with the requirements in Division I, Section 5 of the *AASHTO Standard Specifications for Highway Bridges*, 17<sup>th</sup> Edition (2002) for allowable stress design, or the *AASHTO LRFD Bridge Design Specifications* (current Edition) including current interims for load and resistance factor design. The wall design shall also be in compliance with the **ODOT BDM** and **ODOT GDM**. In case of conflict or discrepancy between these design specifications and manuals, the **ODOT GDM** shall govern. If the wall design life is 3 years or less, the wall need not be designed for seismic loading. Sufficient corrosion protection should be provided in consideration of the temporary wall design life. Design Temporary Geotextile Reinforced Wrapped Face MSE retaining walls (Type 8A) in accordance with [Section 16.6.16](#).

Temporary retaining wall **design shall consider actual construction-related loads, such as operation of large cranes of other large equipment near the wall** which can be significantly higher than **loads imposed on the completed** temporary structure. In this case, the construction equipment loads shall still be considered to be a live load, unless the dynamic and transient forces caused by use of the construction equipment can be separated from the construction equipment weight as a dead load, in which case, only the dynamic or transient loads carried or created by the use of the construction equipment need to be considered live load. As a minimum, the temporary walls shall be designed for a live load surcharge of 250 psf to address routine construction equipment traffic above the wall.

### 16.3.27.3 Performance Requirements

Temporary walls shall be designed to prevent excessive deformation that could result in damage to temporary detour bridge abutment foundations, pavements, and other adjacent structures and facilities. The temporary retaining wall design shall include the determination of actual threshold limits of differential foundation settlement and/or lateral movement that could result in structural damage to adjacent construction. Typical highway structures (including bridges, pavements, and retaining walls) can tolerate 1 to 2 inches of differential foundation settlement and lateral movement prior to unacceptable cracking, displacement, and/or structural damage. If analysis indicates differential foundation settlement and lateral movement will exceed the threshold magnitudes, the contractor shall design remedial works to prevent damage.

## 16.4 CIP Concrete Rigid Gravity Walls

### 16.4.1 General Considerations

Cast-in-place (CIP) gravity retaining walls are reinforced concrete structures that rely on self-weight to resist overturning and sliding forces. Internal stability and external stability (overturning, sliding, bearing capacity, and settlement), and overall (global) stability design of gravity retaining walls shall be performed in accordance with the *AASHTO LRFD Bridge Design Specifications* and the *ODOT GDM*.

### 16.4.2 Geotechnical Investigation

Design of CIP concrete rigid gravity retaining walls requires a geotechnical investigation to explore, sample, characterize and test foundation soils and measure site ground water levels. Geotechnical investigation requirements for wall foundation design are outlined in [Chapter 4](#).

### 16.4.3 Wall Selection Criteria

The decision to select a CIP concrete rigid gravity retaining wall should be based on project specific criteria. This decision should also consider the general wall design requirements contained in [Section 16.3](#). CIP gravity walls are not recommended for soft ground sites, or at any location where significant foundation settlements are anticipated.

### 16.4.4 Wall Height, Footprint and Construction Easement

CIP concrete rigid gravity retaining walls are typically designed to a maximum height of 12 ft. CIP gravity walls typically require an additional lateral construction easement of at least  $1.5 \cdot H$  behind the wall to accommodate open-cut construction, drainage installation, backfill placement and compaction behind the wall. A lateral easement restriction and/or the presence of an existing roadway, structure, or utility within the construction limits could require shoring,

underpinning and/or right-of-way acquisitions that can affect the construction budget and/or schedule.

## 16.4.5 Design Requirements

1. CIP concrete rigid gravity retaining walls shall include adequate subdrainage, including drainage blankets, chimney drains, perforated collector pipes and/or weep holes, to relieve hydrostatic pressures and seepage forces on walls in accordance with AASHTO Article 11.6.6 and [Section 16.3.18](#). Additionally, provide adequate surface drainage facilities, including ditches, gutters, curbs and drop inlets, to intercept and direct water to suitable surface water disposal facilities.
2. Calculate static active lateral earth pressures for CIP concrete rigid gravity wall design using Coulomb earth pressure theory in accordance with AASHTO Article 3.11.5.3 and [Section 16.3.10](#). Calculate static passive earth pressures on walls based on Log Spiral and Trial Wedge theories in accordance with AASHTO Article 3.11.5.4 and [Section 16.3.10](#). Calculate seismic active and passive lateral earth pressures in accordance with AASHTO Article 11.6.5.
3. CIP concrete rigid gravity wall design shall assume the maximum wall-backfill friction angle in accordance with AASHTO Article 3.11.5.3 and AASHTO Table 3.11.5.3-1.
4. Development of an active lateral earth pressure assumes the top of the wall can move outward (translate or rotate about the wall base) during or immediately after backfilling a distance of at least  $0.001 \cdot H$  (dense sand backfill) to  $0.004 \cdot H$  (loose sand backfill), where  $H$  is the wall height. CIP concrete rigid gravity walls restrained from adequate movement are considered to be non-deflecting walls. Design non-deflecting CIP concrete rigid gravity retaining walls for the at-rest lateral earth pressures and compaction induced lateral earth pressures shown on [Figure 16-4](#) in [Section 16.3.11](#).
5. Calculate base sliding resistance in accordance with AASHTO Article 10.6.3.4.
6. In sliding, lateral resistance shall neglect any contribution from passive earth pressure resistance against the embedded portions of the wall if the soil in front of the wall can be removed or weakened by scour, erosion, construction-excavation, freeze-thaw, shrink-swell, or any other means.
7. Assess external stability (overturning, bearing resistance, sliding, and settlement) and overall (global) slope stability for CIP concrete rigid gravity walls in accordance with *the AASHTO LRFD Bridge Design Specifications* and the requirements of the *ODOT GDM*.
8. Where practical, a minimum 4.0-ft-wide horizontal bench shall be provided in front of CIP concrete rigid gravity walls.
9. Design CIP concrete rigid gravity retaining walls for seismic design forces in accordance with AASHTO Article 11.6.5.

## 16.4.6 Concrete Gravity Retaining Walls

Design and detail project specific concrete gravity walls in the contract documents. Standard Drawing BR720 CIP Gravity Retaining wall has been removed from service due to concern with lack of seismic design.

## 16.5 CIP Concrete Semi-Gravity Cantilever Walls

### 16.5.1 General Considerations

Cast-in-place (CIP) semi-gravity cantilever retaining walls are reinforced concrete structures that rely on wall base reaction and friction to resist overturning and sliding forces. Internal stability and external stability (overturning, sliding, bearing capacity, and settlement) and overall stability design of CIP cantilever walls shall be performed in accordance with the *AASHTO LRFD Bridge Design Specifications* and the *ODOT GDM*. Standard Drawings BR705, BR706, BR707, BR708 and BR709 provide design and detail for the following backfill slopes: level backfill with 250psf surcharge, 3H: 1V and 2H: 1V inclined backfill and seismic design for the following seismic lateral wall coefficients:  $kh=0.10$ ,  $kh=0.20$ , and  $kh=0.30$ .

### 16.5.2 Geotechnical Investigation

The design of CIP cantilever retaining walls requires a geotechnical investigation to explore, sample, characterize and test the wall foundation soils and measure site groundwater levels. Geotechnical investigation requirements are outlined in [Chapter 4](#).

### 16.5.3 Wall Selection Criteria

The decision to select a CIP cantilever retaining wall should be based on project specific criteria. This decision should also consider the general wall design requirements contained in [Section 16.3](#). CIP cantilever retaining walls can be formed to meet the most demanding vertical and horizontal alignment requirements. A major disadvantage of the CIP cantilever wall is the relatively low tolerance to post-construction foundation settlements. Cantilever walls are not well suited for soft ground sites—or any location where significant foundation settlements are anticipated.

### 16.5.4 Wall Height, Footprint, and Construction Easement

CIP semi-gravity cantilever retaining walls are typically designed to a maximum height (H) of 24 ft. CIP cantilever walls typically require an additional lateral construction easement of at least  $1.5 \cdot H$  behind the wall heel to accommodate open-cut construction, drainage installation, backfill placement and compaction behind the wall.

A lateral easement restriction and/or the presence of a roadway, structure, or utility within the construction limits could require shoring, underpinning and/or right-of-way acquisitions with impacts to the construction budget and/or schedule.

### 16.5.5 Design Requirements

1. CIP concrete semi-gravity cantilever retaining walls shall have an adequate subdrainage system, including drainage blankets, chimney drains, perforated collector pipes and/or

weep holes, to relieve hydrostatic pressures and seepage forces. The subdrainage system shall be designed based on project-specific data and requirements in accordance with AASHTO Article 11.6.6 and [Section 16.3.18](#). Additionally, provide adequate surface drainage facilities, including ditches, gutters, curbs and drop inlets, to intercept and direct water to suitable surface water disposal facilities.

2. The active lateral earth pressure coefficient ( $k_a$ ) for design of CIP concrete semi-gravity cantilever walls should be calculated using either Coulomb or Rankine earth pressure theory in accordance with the criteria presented in AASHTO Article 3.11.5.3. The active lateral earth pressure shall be applied to a plane extending vertically up from the wall base at the back of the heel. Guidance on application of Coulomb and Rankine theories to cantilever wall design is presented in Figure C3.11.5.3-1 (AASHTO Article 3.11.5.3).
3. Calculate seismic active and passive lateral earth pressures in accordance with AASHTO Article 11.6.5
4. CIP concrete semi-gravity cantilever wall design shall assume the maximum wall-backfill friction angle in accordance with AASHTO Article 3.11.5.3 and AASHTO Table 3.11.5.3-1.
5. CIP concrete semi-gravity cantilever walls restrained from sufficient movement to achieve the active earth pressure condition in accordance with AASHTO Article 3.11.5.3, such as walls bearing directly on bedrock or supported on a deep foundation, are considered to be non-deflecting walls. Design non-deflecting CIP concrete semi-gravity cantilever retaining walls to satisfy internal and external stability under the combined effects of at-rest lateral earth pressure and compaction lateral earth pressure using [Figure 16-4 \(Section 16.3.11\)](#).
6. Design stems of CIP concrete semi-gravity cantilever retaining walls to satisfy internal stability under effects of compaction lateral earth pressures using [Figure 16-4 \(Section 16.3.11\)](#).
7. Assess external stability (overturning, bearing resistance, sliding, and settlement) and overall (global) slope stability of CIP concrete semi-gravity cantilever walls in accordance with the *AASHTO LRFD Bridge Design Specifications* and the *ODOT GDM*.
8. Where practical, a minimum 4.0-ft-wide horizontal bench shall be provided in front of CIP concrete semi-gravity cantilever walls.
9. Design CIP concrete semi-gravity retaining walls for seismic design forces in accordance with AASHTO Article 11.6.5.

### 16.5.5.1 Sliding Resistance

Calculate base sliding resistance in accordance with AASHTO Article 10.6.3.4.

In sliding, lateral resistance shall neglect any contribution from passive earth pressure resistance if the soil in front of the wall can be removed or weakened by scour, erosion, construction-excavation, freeze-thaw, shrink-swell, or any other means. If wall base sliding resistance is inadequate, increase the base width, increase the contribution from passive earth pressure resistance by increasing wall embedment, or add a shear key.



A shear key (base key) at least 2.0 feet wide at the bottom and at least 12 inches in depth may be installed along the base of CIP cantilever walls to provide additional sliding resistance. Sliding resistance may include passive earth pressure resistance in front of the base key for foundation materials consisting of stiff to hard, cohesive soil or “extremely soft” to “soft” rock<sup>3</sup> or granular soils in accordance with Figure 10-20, Section 10.5.5 of *Soils and Foundations, Reference Manual – Volume II*, FHWA NHI-06-089 (FHWA, 2006).

Neglect any contribution to sliding resistance from passive earth pressure against the base key unless the wall footing base is embedded at least 2.0 ft. below subgrade and the ground in front of the footing will not be weakened or removed by freeze-thaw, shrink-swell, scour, erosion, construction excavation, or any other means.

## 16.6 Mechanically Stabilized Earth (MSE) Walls and reinforced slopes

Mechanically stabilized earth (MSE) walls shall be designed (in order of precedence) in accordance with the following:

- *AASHTO LRFD Bridge Design Specifications* (as modified by the *ODOT Geotechnical Design Manual (GDM)*);
- *Design of Mechanically Stabilized Earth Walls and Reinforced Soil Slopes*, NHI-10-024 and NHI-10-025 (FHWA, 2009), and
- **Project specific reinforced backfill special provisions 00596A.**

Unless otherwise noted, MSE wall analysis and design shall assume the following geotechnical properties for the reinforced MSE wall backfill:

- Friction angle of backfill:  $\phi = 34^\circ$
- Backfill cohesion:  $c = 0$  psf
- Wet unit weight of backfill:  $\gamma_{\text{wet}} = 130.0$  pcf
- Active lateral earth pressure coefficient ( $k_a$ ) for wall design shall be calculated using the Coulomb earth pressure theory in accordance with AASHTO Article 3.11.5.3 and [Section 16.3.10](#).

The simplified and coherent gravity methods presented in AASHTO LRFD Bridge Design Specifications are not considered applicable to mechanically stabilized earth with facing batter greater than  $20^\circ$  from vertical; this is the dividing line between MSE wall and reinforced slope. Use the most current FHWA manual *Mechanically Stabilized Earth Walls and Reinforced Soil Slopes Design & Construction Guidelines* by Berg, et al for design of reinforced slopes.

---

<sup>3</sup> “Extremely soft” and “soft” rock refers to the scale of relative rock hardness in accordance with the ODOT Soil and Rock Classification Manual (1987). An “extremely soft” rock has an unconfined compressive strength of less than 100psi, while “soft” rock has an unconfined compressive strength between 1,000 and 4,000psi.

## 16.6.1 General Considerations

MSE walls are internally stabilized by the frictional resistance of layers of steel (inextensible) or geosynthetic (extensible) reinforcement layers embedded within well-compacted, gravel (crushed rock) backfill. MSE walls rely on self-weight to resist overturning and sliding forces. MSE wall stability analysis shall consider the internal, compound, and overall stability failure surfaces shown in AASHTO Figure 11.10.2-1.

MSE walls are relatively flexible compared to other wall systems and can tolerate relatively large lateral deformations and differential vertical settlements. MSE walls are potentially better suited for earthquake loading effects than other wall systems because of their inherent flexibility and energy absorbing capacity.

MSE wall facing options include small (face area  $< 30 \text{ ft}^2$ ) to large (face area  $\geq 30 \text{ ft}^2$ ) square or cruciform-shaped precast concrete panels, full-height precast concrete panels, cast-in-place concrete facing, dry cast and wet cast concrete blocks, welded-wire facing, geocells, and rock-filled gabion baskets. Reinforced slope permanent facing options include vegetation (with erosion control blanket, geogrid or wire form with filter fabric, or geocell), and crushed stone without vegetation (with wire forms or geocell). Consult with the project Landscape Architect, Erosion Control designer regarding facing options.

Geotextile-reinforced, wrapped-faced MSE walls and reinforced slopes are frequently used for construction staging and other temporary works.

## 16.6.2 Geotechnical Investigation

Design of MSE walls requires a geotechnical investigation to explore, sample, characterize and test wall foundation soils and the adjacent ground conditions. Geotechnical investigation requirements are outlined in [Chapter 4](#). At a minimum, the geotechnical information required for wall design includes a subsurface profile including SPT N-values (depth intervals of 5 ft., or less), unit weight, natural water content, Atterberg limit, sieve analysis, soil pH/resistivity, shear strength parameters, settlement/consolidation parameters, foreslope and back slope inclinations, and groundwater levels.

## 16.6.3 Wall Selection Criteria

MSE walls are relatively wide and heavy structures that frequently require large backcuts, shoring, and/or right-of-way acquisitions.

MSE walls are not recommended at locations where erosion or scour may undermine or erode the leveling pad, facing or MSE reinforced backfill.

Do not place underground utilities in the reinforced backfill zone behind MSE walls.

Excavations for utility construction could damage or rupture MSE wall reinforcements - reducing wall stability and causing a failure or collapse of the retaining wall. Fluids from leaking or ruptured utilities could damage or destroy steel or geosynthetic MSE reinforcements and/or wash out of the retaining wall backfill.

## 16.6.4 Wall Height, Footprint, and Construction Easement

MSE wall heights, including the total wall height of tiered or superimposed MSE walls ([Section 16.6.13](#)), shall not exceed 50 ft.

Preliminary reinforcement length (AASHTO Article 11.10.2.1) shall be at least  $0.70 \cdot H$  (where  $H$  is the wall height shown in AASHTO Figure 11.10.2-1), but not less than 8.0 ft. The minimum AASHTO reinforcement lengths are frequently increased for the following reasons:

- Meet internal, external, compound, and global stability requirements;
- Resist loads from high embankments or sloping backfills, heavy surcharges (both temporary and permanent), and bridge footing or minor structure loads; and
- Meet additional or special requirements for tiered or superimposed walls ([Section 16.6.13](#)), back-to-back walls ([Section 16.6.14](#)) and MSE bridge retaining walls ([Section 15.6.15](#)).

MSE wall backfill slopes shall be no steeper than 1v:2h.

A minimum 4.0-ft-wide horizontal bench shall be provided in front of MSE walls in accordance with AASHTO Article 11.10.2.2. AASHTO Figure 11.10.2-1 provides a sectional view showing a typical MSE wall leveling pad, front face embedment and the required horizontal bench.

## 16.6.5 Minimum Wall Embedment

Minimum MSE wall embedment depth below lowest adjacent grade in front of the wall shall be in accordance with AASHTO Article 11.10.2.2, including the minimum embedment depths indicated in Table C11.10.2.2-1.

The minimum MSE wall embedment depth, as shown in AASHTO Figure 11.10.2-1, shall be based on external stability analysis (sliding, bearing resistance, overturning, and settlement) and the global (overall) stability requirements in *AASHTO LRFD* Chapters 10 and 11 and the *ODOT GDM*.

The embedment depth of MSE walls along streams and rivers shall be at least 2.0 ft. below the potential scour elevation in accordance with AASHTO Article 11.10.2.2. The potential scour elevation shall be established in accordance with *AASHTO LRFD*, the *ODOT BDDM*, and the *ODOT Hydraulics Manual*.

## 16.6.6 Soil Failure - External and Overall Stability Analysis

External stability analysis shall include calculation of sliding resistance, soil bearing resistance, overturning, at the applicable LRFD load factor combinations and resistance factors. Slope stability analysis shall also consider compound stability failure surfaces that pass through the

MSE wall reinforced backfill. Overall (global) stability shall be in accordance with [Section 16.6.6.3](#).

### 16.6.6.1 Sliding Resistance

Sliding resistance along the base of the MSE wall shall be calculated using the procedures in AASHTO Article 10.6.3.4. Calculate sliding resistance using the using parameters in AASHTO Tables 10.5.5.2.2-1 and 11.5.7-1.

Neglect any beneficial effect of external loads on MSE walls (such as live load traffic surcharge) that increase sliding resistance.

At a minimum, sliding stability analysis shall determine the minimum resistance along the following potential failure surfaces:

- Surface within reinforced backfill;
- Surface within foundation soil or rock material;
- Interface between reinforced backfill and foundation soil/rock material;
- Interface between reinforced backfill and reinforcement; and
- Interface between foundation soil or rock and reinforcement.

In sliding, neglect any contribution to stability from passive earth pressure resistance. Neglect any benefit the wall facing elements provide to sliding stability.

### 16.6.6.2 Soil Bearing Resistance, Overturning, and Settlement

Soil bearing resistance design shall be in accordance with Chapter 10 in *AASHTO LRFD* and the *ODOT GDM*. The effective footing dimensions of eccentrically loaded MSE walls shall be evaluated in accordance with AASHTO Article 10.6.1.3. Calculate foundation settlement **at the service limit state** in accordance with AASHTO Article 10.6.2.4 and [Chapter 7](#) and [Chapter 16](#).

Excessive MSE wall foundation settlement can result in damage to the wall facing, coping, traffic barrier, bridge superstructure, bridge end panel, pavement, and/or other settlement-sensitive elements supported on or near the wall. Techniques to reduce damage from post-construction settlements and deformations include:

- A “two-stage” MSE wall system where the first stage is a flexible-faced MSE wall (e.g., geotextile wrapped face or welded-wire) to preload and/or surcharge the foundation, followed by the permanent wall facing in front of the first-stage MSE wall. A wall minimum “wait period” is required after construction of the first-stage MSE wall to allow enough time for soil consolidation to reduce or eliminate damaging, long-term (post-construction) foundation settlements.
- Prefabricated vertical drains or wick drains may be appropriate to accelerate the time-rate of foundation soil consolidations and reduce total construction time. *Prefabricated Vertical Drains, Volume I, Engineering Guidelines*, FHWA/RD-86/168 (FHWA, 1986) provides detailed guidance for the planning, design and construction of prefabricated

vertical drains. Material and construction requirements for wick drains are provided in Section 00435.

- Full-height vertical sliding joints through the rigid wall facing elements and appurtenances.
- Ground improvement or reinforcement techniques as described in [Chapter 12](#). Staged preload/surcharge construction, using suitable onsite materials and/or imported fill, may be a relatively cost-effective method to increase MSE wall stability and/or reduce settlement.

### 16.6.6.3 Overall Stability

The overall (global) stability of MSE walls shall be evaluated in accordance with AASHTO Articles 11.6.2.3 and 11.10.4.3, and *ODOT GDM* [Chapter 7](#), [Chapter 15](#), and [Chapter 16](#). The mass of the MSE wall (or the “foundation load”) may be assumed to contribute to the overall stability of the slope.

### 16.6.6.4 Seismic External Stability

MSE walls have performed relatively well during earthquakes—tolerating large lateral deformations and differential vertical settlements without failure or collapse. MSE walls are potentially better suited for earthquake loading than other retaining wall types because of their inherent flexibility and energy absorbing capacity.

Design MSE retaining wall seismic external stability in accordance with AASHTO Article 11.10.7 and [Section 16.3.13](#).

## 16.6.7 Internal Stability Analysis

Internal stability analysis shall include calculation of reinforcement loading, pullout, and reinforcement-facing connection strengths.

### 16.6.7.1 Loading

The maximum factored tension loads in MSE wall reinforcements ( $T_{max}$ ) shall be calculated at each reinforcement level using either the Simplified Method or Coherent Gravity Method approach in accordance with AASHTO Article 11.10.6.2. The factored load applied to the reinforcement-facing connection ( $T_o$ ) shall be equal to the maximum factored tension reinforcement load ( $T_{max}$ ) in accordance with AASHTO Article 11.10.6.2.2.

### 16.6.7.2 Reinforcement Pullout

Calculate MSE wall reinforcement pullout capacity in accordance with AASHTO Article 11.10.6.3.

The location of the maximum surface of stress for steel (inextensible) and geosynthetic (extensible) reinforced MSE walls shall be determined in accordance with AASHTO Figure 11.10.6.3.1-1. Reinforcement pullout shall be checked at each reinforcement level in accordance

with AASHTO Article 11.10.6.3.2 and the effective pullout length in the reinforcement zone shall be calculated using AASHTO Equation 11.10.6.3.2-1.

The design pullout friction factor ( $F^*$ ) and scale effect correction factor ( $\alpha$ ) for geosynthetic reinforcement shall be from product-specific laboratory testing or default values given in AASHTO Figure 11.10.6.3.2-2 and Table 11.10.6.3.2-1. Laboratory tests to determine  $F^*$  and  $\alpha$  are presented in Berg et al., 2009 Volume 2, Appendix B.

### **16.6.7.3 Reinforcement Strength**

Design steel and geosynthetic reinforcement strength in accordance with AASHTO Article 11.10.6.4.

In accordance with AASHTO Article 11.10.6.4, the maximum factored reinforcement loads shall be calculated at each reinforcement level in the MSE wall based on AASHTO Equation 11.10.6.4.1-1. The maximum factored load at reinforcement-facing connections shall be calculated based on AASHTO Equation 11.10.6.4.1-2.

The nominal, long-term reinforcement design strength shall be calculated at each reinforcement level in accordance with AASHTO Articles 11.10.6.4.3a (steel reinforcement) and 11.10.6.4.3b (geosynthetic reinforcement).

### **16.6.7.4 Reinforcement-Facing Connection Strength**

The nominal, long-term reinforcement-facing connection design strength ( $T_{ac}$ ) shall be calculated as specified in AASHTO Article 11.10.6.4.4a (steel reinforcement) and AASHTO Article 11.10.6.4.4b (geosynthetic reinforcement).

The reinforcement-facing connection strength of MSE walls shall be designed to resist lateral loads on the facing from the following factors:

- Lateral earth pressure and water pressure loads;
- Compaction and construction loads;
- Live loads and surcharges, including traffic loads;
- Dead loads and surcharges, including backslope and approach fill;
- Structure foundation loads; and
- Seismic loads.

The reinforcement-facing connection strength of MSE walls shall also be designed to resist stresses due to differential movement between the facing and the reinforcement resulting from backfill compaction, differential settlement between the wall facing and reinforced backfill, or other effects.

### **16.6.7.5 Seismic Internal Stability**

Design MSE retaining wall seismic internal stability in accordance with AASHTO Article 11.10.7.2.

## 16.6.8 Wall Drainage

MSE walls shall include an internal drainage system that meets the following requirements:

- Subsurface drainage design requirements in *ODOT GDM Section 16.3.18*, *AASHTO LRFD*, and *NHI-10-024 (FHWA, 2009)*;
- Prevents infiltration of aggressive runoff, seepage and/or groundwater into the facing or reinforced backfill zone - avoiding the resulting damage from corrosion or degradation effects; and
- Intercepts surface and subsurface water from around and beneath the MSE wall, including the reinforced backfill zone, and rapidly removes the water to a suitable discharge location.

MSE wall subdrainage typically consists of a suitable-placed trench, chimney, and/or blanket drain with perforated collector drainpipes to intercept and remove groundwater seepage and percolating surface runoff. The collector pipe is connected to a solid pipe that should discharge into an approved drainage ditch or storm drain system. Provide properly located clean outs for the collector pipe. Permeable materials used in drainage systems shall be encapsulated in a drainage geotextile (geotextile filter) layer. The drainage system **should ideally** be designed to maintain groundwater levels below the base of the MSE wall reinforced backfill zone. **For the case where wall drainage cannot be provided, include hydrostatic pressure as required in the design of the wall.**

Perforated collector and solid pipes shall be at least 6in diameter to allow for periodic pipe flushing and cleaning, irrespective of discharge capacity requirements. Pipe discharge points shall be readily accessible to maintenance personnel. Provide metal screens or secure caps at pipe ends to prevent rodent entry.

Design of walls along rivers, creeks, canals, detention basins, retention basins, or other situations with potential for water level fluctuation shall apply a 3.0 ft. (min.) differential hydrostatic head to the MSE wall to simulate rapid drawdown conditions in accordance with AASHTO Article 11.10.10.3. A greater hydrostatic head should be used to model larger river or tidal level fluctuations if supported by hydraulics data.

See *Section 5.3 Drainage*, in *NHI-10-024 (FHWA, 2009)* for examples of common drainage details for MSE walls.

## 16.6.9 Traffic Railing

The requirements of this section are for traffic railing on MSE walls, and are supplemental to the requirements of [Section 16.3.22.1](#).

### **Fixed Bridge Rail on Self Supporting (Moment) Slab for MSE walls:**

Where TL-**3** traffic railing is acceptable, a self-supporting moment slab with 32-in. Type “F” bridge rail (ODOT Standard Drawing BR760) may be used on MSE walls.

NCHRP Web Only Document 326: Design Guidelines for Test Level-3 through Test Level-5 Roadside Barrier Systems Placed on Mechanically Stabilized Earth Retaining Walls (NCHRP 326) is an update to NCHRP Report 663. NCHRP 326 provides recommendations for designing MASH TL-3, MASH TL-4, and MASH TL-5 barrier systems. . Table 16-5 presents the recommended design load and minimum barrier moment slab configuration from NCHRP 326. The dynamic design load is used for barrier moment slab structural design. The equivalent static load is used to size the moment slab for external stability and to calculate additional pullout and yielding pressures for the wall reinforcement.

**Table 16-5 Dynamic Load and Equivalent Static Load for Moment Slab Design**

Test Designation	TL-3	TL-4	TL-4-2	TL-5-1	TL-5-2
Dynamic Load, $L_d$ Height, (kips)	70	70	80	160	260
Equivalent Static Load, $L_s$ (kips)	23	28	28	80	132
Minimum Barrier Height, $H_{min}$ (in.)	32	36	>36	42	>42
Effective Barrier Height, $H_e$ (in.)	24	25	30	34	43
Minimum Moment Slab Width, $W_{min}$ (ft)	4	4.5	4.5	7	12
Minimum Length of Barrier, $B_L$ (ft.)	10	10	10	15	15

Notes:

1.  $L_s$  is the equivalent static lateral load applied at height  $H_e$ , calculated based on the static resistance deemed more critical for the barrier as follows: the overturning resistance for TL-3, TL-4 and TL-5-1 barriers and the sliding resistance for TL-5-2 barrier .
2. Table values for TL-3 are revised from the recommendations in NCHRP Report 663.

Design MSE walls to ensure soil reinforcements do not rupture or pullout due to vehicle impact loads on traffic railing. NCHRP 326 contains tabular data for lateral traffic impact design.



Values in these tables for TL-3 loading are revised from those presented in NCHRP 663. Loading of the top two layers of reinforcement resulting from collision loading is shown in NCHRP 326 Figure 9-4 Pressure distribution ( $p_{dp}$ ) for reinforcement pullout, Figure 9-6 Line load ( $Q_{dp}$ ) for reinforcement pullout, Figure 9-7 Pressure distribution  $p_a$  for reinforcement yield, and Figure 9-8 Line load  $Q_{dy}$  for reinforcement yield. Information from these tables are reproduced in Tables 15.6 to 15.9 below.:

**Table 16-6 Pressure Distribution ( $p_{dp}$ ) for Reinforcement Pullout and Tributary Height**

Test Designation	First Layer		Second Layer	
	$p_{dp-1}$ (psf)	$h_1$ (ft)	$p_{dp-2}$ (psf)	$h_2$ (ft)
TL-3	370	2.25	167	2.5
TL-4-1	370	2.25	270	2.5
TL-4-2	370	2.25	270	2.5
TL-5-1	725	1.6	400	2.5
TL-5-2	1240	1.6	680	2.5

**Table 16-7 Line Load ( $Q_{dp}$ ) for Reinforcement Pullout**

Test Designation	Line Load (lb/ft)	
	First Layer, $Q_{dp-1}$	Second Layer, $Q_{dp-2}$
TL-3	835	415
TL-4-1	835	675
TL-4-2	835	675
TL-5-1	1160	1000
TL-5-2	1990	1700

Table 16-8 Pressure Distribution ( $p_{dy}$ ) for Reinforcement Yield

Test Designation	First Layer		Second Layer	
	$p_{dy-1}$ (psf)	$h_1$ (ft)	$p_{dy-2}$ (psf)	$h_2$ (ft)
TL-3	1415	2.25	300	2.5
TL-4-1	1755	2.25	300	2.5
TL-4-2	1755	2.25	300	2.5
TL-5-1	3250	1.6	485	2.5
TL-5-2	4440	1.6	675	2.5

Table 16-9 Line Load ( $Q_d$ ) for Reinforcement Yield

Test Designation	Line Load (lb/ft)	
	First Layer, $Q_{d-1}$	Second Layer, $Q_{d-2}$
TL-3	3185	750
TL-4-1	3950	750
TL-4-2	3950	750
TL-5-1	5200	1215
TL-5-2	7105	1690

**Precast Median Barrier:**

Where TL-3 traffic railing is acceptable, anchored precast wide base median barrier (RD500) may be used when designed in accordance with *AASHTO LRFD* and the *ODOT GDM*.

Anchored precast barriers shall be located at least 3.0 ft. clear from the back of the wall face, and shall be anchored with two vertical anchors on each side of each precast section, in accordance with the “Median Installation” option shown on ODOT Standard Drawings RD515 and RD516.

**Guardrail:**

Where TL-3 traffic railing is acceptable, standard guardrail (BR400) may be used when designed in accordance with *AASHTO LRFD* and the *ODOT GDM*.

Design MSE wall soil reinforcement in accordance with AASHTO Articles 11.10.10.2 and 11.10.10.4 and the *ODOT GDM*.

Where guardrail posts are required to be constructed in MSE Walls, the posts shall be placed at a minimum horizontal distance of 3.0 ft. from the back of the wall face to the back of the guardrail post, driven or placed at least 5.0 ft. below grade and spaced at locations to miss the reinforcement materials where possible. Installation of the guardrail shall not damage any portion of the retaining wall. If the reinforcement cannot be missed, the wall shall be designed accounting for the presence of an obstruction in the reinforced soil zone using one of the following methods:

1. Assuming the reinforcement must be partially or fully severed in the location of the guardrail post, design the surrounding reinforcement layers to carry the additional load that would have been carried by the severed reinforcements. The portion of the wall facing in front of the guardrail post shall be made stable against a toppling (overturning) or sliding failure. If this cannot be accomplished, the soil reinforcements between the guardrail post and the wall face can be structurally connected to the obstruction such that the wall face does not topple, or the facing elements can be structurally connected to adjacent facing elements to prevent this type of failure. **Alternatively, to avoid severing reinforcement, place sleeves at post locations during wall construction and providing sufficient reinforcement as required for stability.**
2. Place a structural frame around the guardrail post capable of carrying the load from the reinforcements connected to the structural frame in front of the obstruction to the reinforcements connected to the structural frame behind the obstruction.
3. If the soil reinforcements consist of discrete, inextensible (steel) strips and depending on the size and locations of the guardrail posts, it may be possible to splay the reinforcements around the guardrail posts. The splay angle, measured from a line perpendicular to the wall face, shall be small enough that the splaying does not generate moment in the reinforcement or the connection of the reinforcement to the wall face. The tensile resistance of the splayed reinforcement shall be reduced by the cosine of the splay angle.

Method 3 above would be effective if guardrail posts are installed at the same time as the MSE wall is constructed (i.e., the wall is built around the guardrail posts). If the guardrail posts are installed after the wall is constructed, it is possible that the splayed reinforcements were installed in the wrong location and the guardrail post installation could damage them. It may also be possible to build the wall around casings or guides, such as Corrugated Metal Pipe (CMP), into which the guardrail posts could be installed after the wall is completed.

### **16.6.10 Corrosion**

Corrosion protection is required for all permanent MSE walls and for temporary MSE walls (design life of three years or less) in aggressive environments as defined in AASHTO Article 11.10.6.4.2. AASHTO Article 11.10.2.3.3 provides design guidance for corrosion protection of MSE walls.

As discussed in [Section 16.3.21](#), aggressive environmental conditions in Oregon are typically associated with snow or ice removal zones and marine environment zones. In snow/ice removal zones, where aggressive deicing materials are likely to be used, protect MSE wall steel reinforcements from the corrosive effects of aggressive runoff with a properly designed and detailed impervious membrane layer placed below the pavement and above the top level of backfill reinforcement. The membrane shall be sloped to quickly move runoff seepage to a drainage collector pipe located behind the reinforced backfill zone.

### **16.6.11 Two-Stage Facing (MSE Retaining Wall Systems)**

Design two-stage facing for MSE retaining wall system in accordance with the methodologies and procedures presented in Section 5.4.7 (Two-Stage Facing), *Design and Construction of Mechanically Stabilized Earth Walls and Reinforced Soil Slopes* (FHWA, 2009).

### **16.6.12 (Reserved for Future Use)**

### **16.6.13 Tiered or Superimposed Walls**

Design tiered or superimposed MSE walls in accordance with the methodologies and procedures presented in Section 6.2 Superimposed (Tiered) MSE Walls, *Design and Construction of Mechanically Stabilized Earth Walls and Reinforced Soil Slopes* (FHWA, 2009). FHWA (2009) shall be used to address aspects of tiered wall design not covered in the *ODOT GDM* or *AASHTO LRFD*.

The total height (H) of a tiered or superimposed MSE retaining wall shall be the sum of the heights of the lower tier wall ( $H_2$ ) and the upper tier ( $H_1$ ) as shown on Figure 6.7, Section 6.2 (FHWA, 2009). The total height (H) of a tiered MSE retaining wall height shall not exceed 50 ft. In accordance with FHWA (2009), where the face-to-face distance (D) between the lower and upper MSE wall tiers exceeds at least  $1.5 \cdot H_2$ , these walls are not considered tiered and may be designed independently.

Perform seismic external stability design of tiered MSE walls according to [Section 16.6.6.4](#).

Perform seismic internal stability design of tiered MSE walls according to [Section 16.6.7.5](#).

General design guidance that applies to tiered MSE walls is provided in [Section 16.3.5](#).

### **16.6.14 Back-to-Back Walls**

Design back-to-back MSE walls in accordance with the methodologies and procedures presented in Section 6.4 Back-to-Back MSE Walls in *Design and Construction of Mechanically Stabilized Earth Walls and Reinforced Soil Slopes* (FHWA, 2009).

## 16.6.15 MSE and GRS-IBS Bridge Retaining Walls

### 16.6.15.1 MSE Bridge Retaining Walls

MSE bridge retaining walls with either steel or geogrid reinforcements may be designed to support bridge abutments with spread footings or pile foundations.

MSE bridge retaining walls shall meet the following requirements as needed to provide for adequate personnel access for maintenance and inspection of bridge bearings and shear lugs:

- Provide a horizontal clear distance from the MSE wall **back face** to the front of the adjacent bridge spread footing or pile cap of at least 3 ft.; and
- Provide a vertical clear distance from finish grade behind the wall facing to the base of the overhead bridge superstructure of at least 4 ft.; for bridges with a solid bottom, such as a concrete box girder, provide 5 ft. minimum.

The above minimum distance requirements for personnel access are in addition to all other applicable design requirements in the ODOT GDM. These minimum distances are shown in [Figure 16-6](#).

Design MSE bridge retaining walls in accordance with the following:

- *ODOT GDM*;
- *AASHTO LRFD*; and
- Section 6.1 (Bridge Abutments) **in** *Design and Construction of Mechanically Stabilized Earth Walls and Reinforced Soil Slopes*" (FHWA, 2009).

In case of a conflict or discrepancy between the above design references, the order of precedence shall be *ODOT GDM*, *AASHTO LRFD*, and then *FHWA*.

Design MSE walls supporting bridge abutment spread footings using the following values of bearing resistance of the reinforced backfill zone:

- For Service Limit State, bearing resistance = 4,000 psf
- For Strength Limit State, factored bearing resistance = 7,000 psf
- For Extreme Event Limit State, factored bearing resistance = 8,000 psf

Design MSE bridge abutment walls at pile or drilled shaft supported abutments for horizontal bridge loads dependent on the type of deep foundation support if recommended in the geotechnical report.

- Isolating piles from MSE construction by placing casing larger than the pile size is one way to mitigate the downdrag as well as horizontal stresses while the casing remains unfilled. Piles are driven and isolation casing is placed prior to MSE wall construction. The space between the pile and isolation casing is filled after MSE wall construction and before pile cap construction. Corrugated metal pipe and pea gravel infill are materials that have been successfully used for pile isolation.

- For deep foundations without isolation casing and constructed before the MSE wall, evaluate downdrag forces induced by MSE wall construction and compression of foundation soil.
- In all cases consider the effect of pile spacing, skewed abutment corners, and other obstructions that may interfere with soil reinforcement. Where reinforcement layers at wall corners stagger/intersect, consider cover required between reinforcement layers, where metal reinforcement is near steel piles, casings, culverts, or other metal obstructions consider cover required between dissimilar metals.
- Consider the effect of seismic displacement and seismic forces transferred from the bridge.

Facing shall be CIP reinforced concrete, reinforced precast concrete panels, dry cast concrete blocks, wet cast concrete blocks, or sprayed on concrete/mortar fascia constructed after welded wire facing (two-stage wall). Installing one of these facing types in front of a wire-faced MSE system complies with this requirement.

Do not place integral abutment bridge foundations on top of, or through, MSE walls.

Full-height precast concrete facing panels shall not be used for MSE bridge retaining walls.

### 16.6.15.2 MSE Bridge Retaining Walls with Steel Reinforcements

The following design requirements apply to spread footing abutments:

- Provide a clear distance of at least 18 in. between the back of the MSE wall facing and the front edge of the bridge abutment spread footing.

The following design requirements apply to pile supported abutments:

- Provide a clear distance of at least 18 in. between the back of MSE wall facing and the front edge of the nearest pile or pile casing.
- Provide a clear distance of at least 6 in. between the back of the wall facing and the pile cap.

### 16.6.15.3 MSE Bridge Retaining Walls with Geogrid Reinforcements

The following design and construction requirements apply to spread footing abutments:

- [Figure 16-6](#) provides a typical sectional view of a geogrid-reinforced MSE wall supporting a bridge abutment spread footing.
- Geogrid-reinforced MSE walls supporting bridge abutments shall use a geogrid reinforcement product listed under the product category name *Type 1 MSEW Geogrid* on the ODOT Qualified Products List (QPL).

- The facing/reinforcement connection system shall be an approved mechanical connection system that does not rely on the frictional resistance between the soil reinforcement (geogrid) and the facing blocks.
- The geogrid-reinforced MSE wall height ( $H_1$  in [Figure16-6](#) [Figure16-8](#)) shall not exceed 23 ft.
- The bridge abutment height ( $H_2$  in [Figure15-6](#)) shall not exceed 10 ft.
- Total wall height ( $H'$  in [Figure15-6](#)) shall not exceed 33 ft.
- Geogrid reinforcement vertical spacing ( $S_v$ ) shall not exceed 16 in. between layers.
- MSE walls shall be reinforced with uniformly spaced, horizontal geogrid layers along the entire height of the wall as indicated in [Figure16-6](#).
- The vertical distance between the uppermost geogrid reinforcement layer and the top surface grade behind the wall facing shall not exceed 16 in.
- The depth of wall facing below the lowest reinforcement layer shall not exceed 8 in.
- The width of the bridge abutment spread footing, supported on the geogrid-reinforced MSE wall, shall be at least 2.0 ft., but not greater than 15.0 ft.

The following design requirements apply to pile supported abutments:

- For pile foundations through MSE walls, provide a clear distance of at least 18 in. between the back of MSE wall facing and the front edge of the nearest pile **or pile casing**; and
- Provide a clear distance of at least 6 in. between the back of the wall facing and the pile cap.

Figure 16-5 MSE Wall Supporting Bridge Abutment Spread Footing (Geogrid Reinforcements)

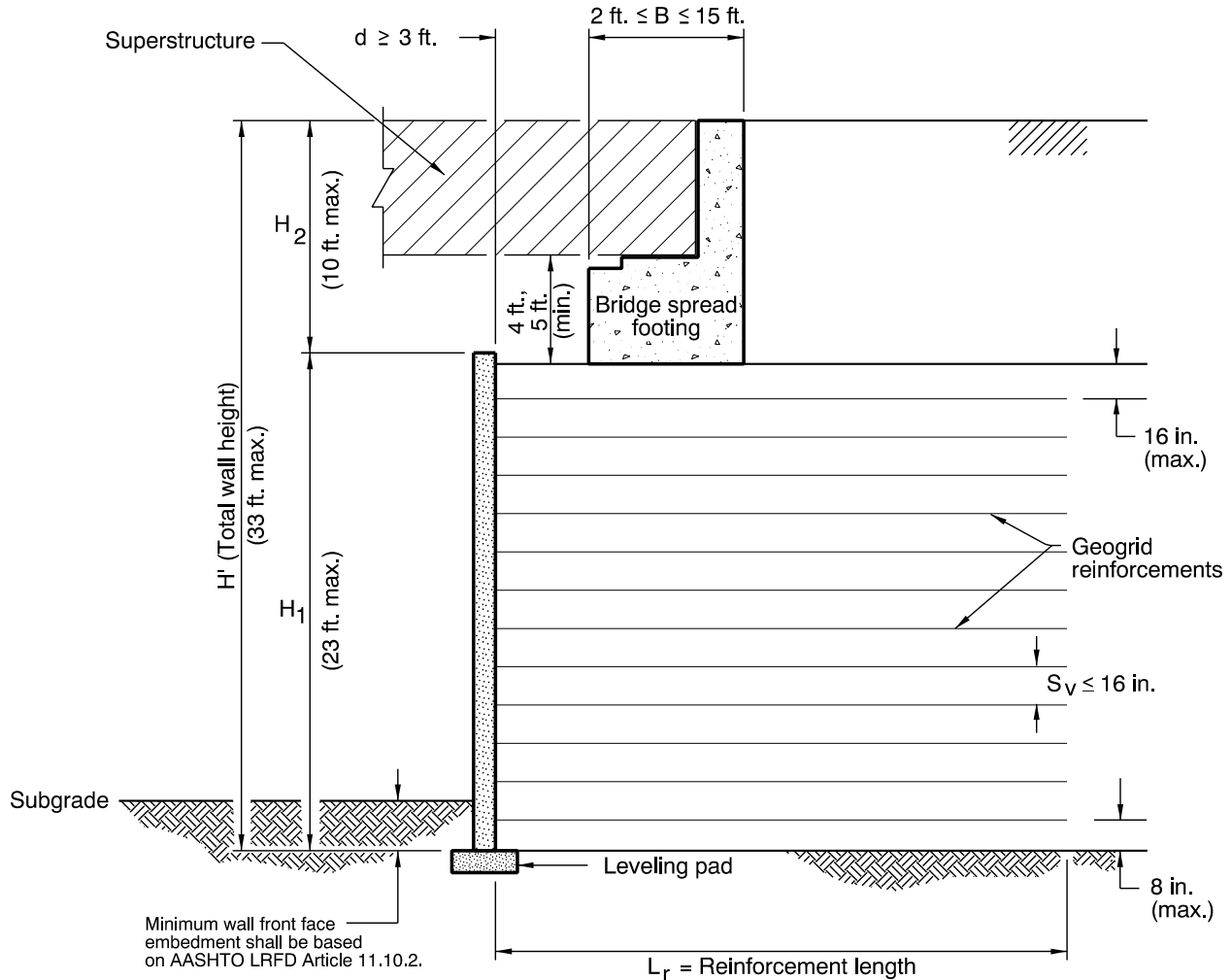

### 16.6.15.4 Geosynthetic Reinforced Soil Integrated Bridge System (GRS-IBS) Bridge Abutment

Geosynthetic Reinforced Soil Integrated Bridge System (GRS-IBS) bridge abutments are part of FHWA's Every Day Counts (EDC) initiative to reduce bridge construction time and cost. FHWA prepared design report/manuals, and sample construction specifications and drawings for its use. These resources may be found on [FHWA's Accelerating Innovation](#) website. GRS-IBS integrates the bridge structure with the approach roadway to create a jointless system. GRS-IBS abutments have been constructed in several states across the nation since 2005.

GRS-IBS components and functions:

- GRS abutment and wingwalls with closely spaced geotextile or geogrid reinforcement layers comprise the GRS mass. A bearing bed beneath the beam seat serves as an embedded footing. Concrete on a compressible foam board creates a buffer between the block facing and the beam seat bearing area. The bearing bed consists of more densely



spaced geosynthetic reinforcement layers to distribute load in the GRS mass. The GRS mass behaves as a composite, internally stabilized unit. The facing elements of the GRS mass serve as surface protection; the facing is not a primary support of the GRS mass. The wall/abutment embedment, bearing width, and foundation improvements (if needed) are based on the required geotechnical bearing resistance, wall settlement limitations, and all internal, external, and overall (global) wall stability requirements.

- The transition from the bridge to the approach roadway (integrated approach) is composed of a GRS mass compacted behind the end of the bridge beams. Provide integrated approach for a minimum length of 12-feet or 3-feet beyond the cut-slope excavation limit, whichever is greater. Concrete approach slabs are not required.

Design GRS-IBS bridge abutments and retaining walls using LRFD methodology in accordance with the following in order of precedence:

- ODOT GDM, ODOT BDM and ODOT Hydraulics Manual
- FHWA-HRT-17-080, *Design and Construction Guidelines for Geosynthetic Reinforced Soil Abutments and Integrated Bridge Systems*, except as noted otherwise in the above ODOT manuals
- AASHTO, 2017, *LRFD Bridge Design Specifications*, American Association of State Transportation and Highway Officials, 8th Edition (with current Interims)
- FHWA NHI-10-024 Volume I and NHI-10-025 Volume II, *Design and Construction of Mechanically Stabilized Earth Walls and Reinforced Soil Slopes*, (Berg et al., 2009)

[Figure 16-7](#) provides a typical sectional view of a GRS-IBS bridge abutment and approach for an application in cut. In cut applications, the base may be truncated to reduce excavation, backfill and reinforcement.

Overview of design and construction constraints for use of GRS-IBS:

- Geotechnical investigations outlined for MSE walls are applicable for GRS-IBS.
- Follow the ODOT BDM 1.10.5.3 and related sections when GRS-IBS is considered at water crossings.
- GRS-IBS may be considered for locations with a low seismic hazard ( $A_s \leq 0.15g$  for the 1000 year return period).
- Maximum 30 ft. wall height
- Maximum reinforcement spacing:
  - GRS backfill: 8-inch maximum spacing based on typical dry cast block size. The FHWA manual limits the primary reinforcement to less than or equal to 12 inches.
  - Beam seat and bearing bed: one half the GRS backfill reinforcement spacing
  - Integrated approach behind the bridge superstructure: 12-inch maximum wrap layers with fill placed and compacted in not more than 6-inch lifts and an intermediate reinforcement layer with each lift.
- The base of the wall may be truncated to reduce excavation. Wall embedment, bearing width, and foundation improvements (if needed) are based on geotechnical evaluation,

wall settlement limitations, and all internal, external, and overall (global) wall stability evaluation. Provide 8 ft. minimum wall bearing width and 2 ft. minimum embedment.

- Use a concrete or gravel leveling pad to provide a uniform, flat bearing surface to support the facing blocks. Foundation settlement serviceability criteria for MSE walls in [Section 16.3.15](#) apply. Unless otherwise specified, or evaluated with refined analysis, use the allowable relative distortions between adjacent foundations given in AASHTO C10.5.2.2.
- The facing blocks are frictionally connected to the reinforcement layers, except the top three courses of facing block are also filled with concrete and pinned with rebar.
- Use geosynthetic reinforcement with strength not less than 400 lb/in and meeting the requirements of Boilerplate Special Provision SP02320 Geosynthetics Table 02320-7, Geotextile Property Values for Geosynthetic Reinforced Retaining Walls. Limit the required reinforcement strength to less than the reinforcement strength at 2 percent strain.
- The bearing reinforcement zone serves as an embedded footing within the GRS mass. The reinforcement density is doubled in this zone and extends at least 2 ft. beyond the beam seat. The bearing bed depth is based on internal stability and should not be less than 5 courses.
- The beam seat is designed to satisfy the 4,000 psf service limit bearing stress and 7,000 psf strength limit bearing capacity. The purpose of the beam seat is to ensure that the superstructure bears on the GRS abutment and not the wall facing block, and to provide the necessary clear space between the superstructure and the wall face.
- Except as noted below, compact reinforced backfill that is placed within 3 feet behind wall facing units to 95% of maximum density using walk-behind vibratory rollers or vibratory plate compactors that have sufficient static and dynamic forces to achieve compaction without causing distortion of the wall facing units. Compact reinforced backfill that is placed 3 feet or more behind wall facing units to 95% of maximum density using riding smooth drum vibratory roller or other suitable equipment made specifically for compaction. The top 5 feet should be compacted to 100% of maximum density, Granular Structure Backfill is recommended for its demonstrated ability to achieve the required compaction using AASHTO T-99.
- For GRS-IBS at water crossings, use open-graded aggregate as the reinforced backfill for the full reinforced width and to the height of the design flood elevation for bridge. Encapsulate this material with a geotextile filter along the interface of the subgrade beneath it, the retained backfill behind it, and the reinforced backfill above it. As field density tests are not suitable for open-graded backfill, development of a procedural specification and greater inspection presence for the compaction quality assurance is needed. NTPEP reports have been prepared for geosynthetic tested using well-graded backfill material; therefore additional geosynthetic testing is also required where open-graded backfill is used. Long term tensile strength of reinforcement should include a reduction factor for installation damage based on the specific reinforcement and open-graded aggregate properties (i.e., maximum particle size, gradation, angularity).

- Limit use to short span bridges and beam seats meeting the bearing requirements above. The majority of bridges built with GRS-IBS have spans less than 100 ft. The FHWA implementation guide recommends that engineers limit bridge spans to 140 ft until more research has been completed.

Provide adequate background information and documentation in the **Feasibility Study**, TS&L Report **or DAP narrative** for the structure type selections. Minimum requirements include:

- Survey – Right of Way, buried obstructions, wetlands limits
- Geotechnical Subsurface Exploration and Preliminary Geotechnical Report – Evaluate settlement (total and differential), identify groundwater levels, discuss the need for foundation improvements
- Structure - Design life, durability and corrosion protection measures
- Environmental – Discuss environmental constraints
- Constructability- Discuss constructability challenges, if present
- Backfill - Compaction and drainage provisions
- Cost Comparison of structure options considered

Other relevant project specific information required by the [Bridge TS&L template](#)

Figure 16-6 GRS-IBS Abutment Section

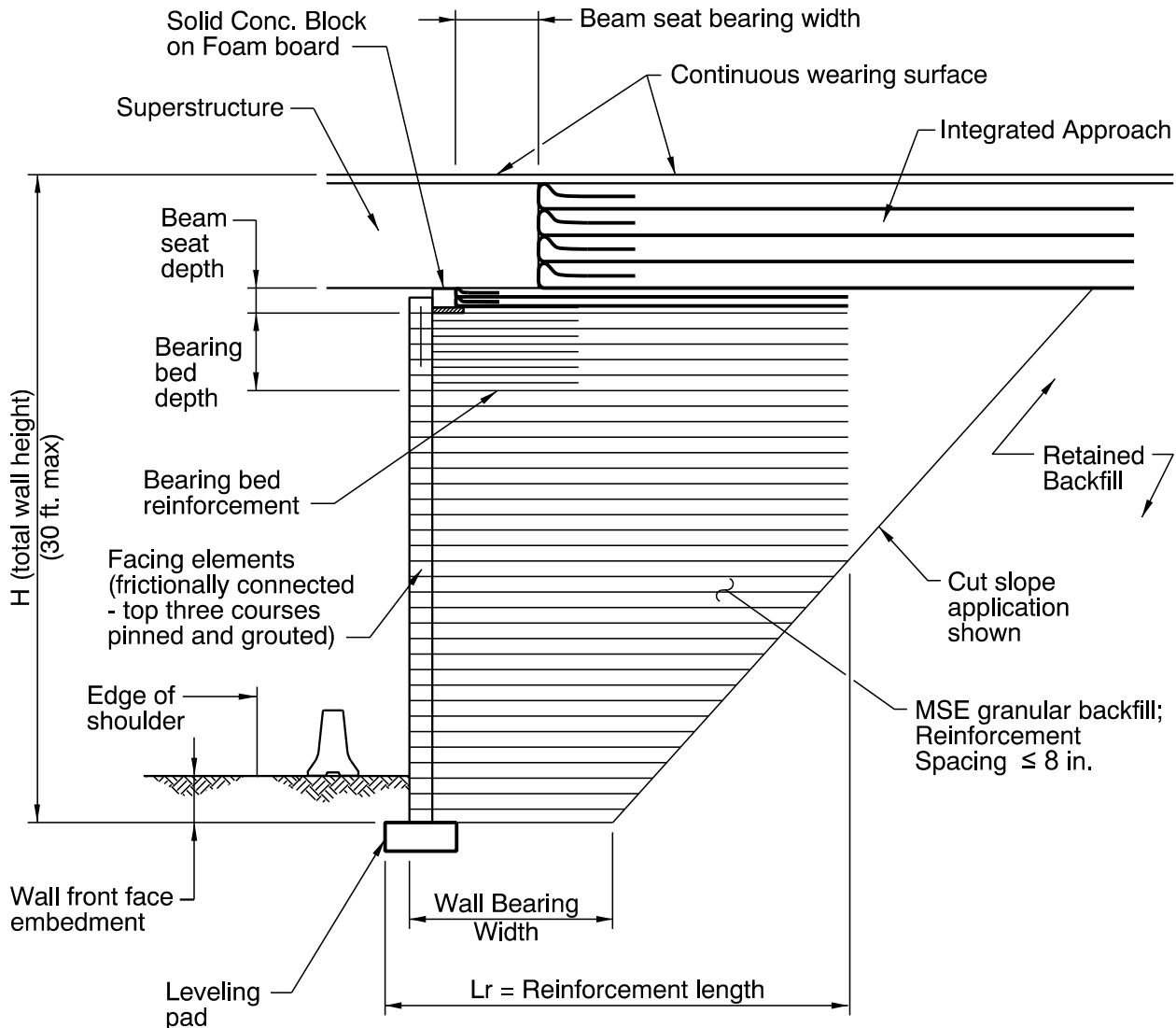

### 16.6.16 Temporary Geotextile-Reinforced MSE Wall

This section presents design and construction requirements for temporary wrapped-face, geotextile-reinforced MSE walls. Temporary geotextile walls consist of continuous, sheet-type geotextile reinforcement layers constructed alternatively with horizontal layers of compacted MSE wall backfill. The wall face is formed by wrapping each geotextile layer around and back into the overlying lift of backfill. A typical temporary geotextile wall is shown in [Figure 16-8](#).

Figure 16-7 Temporary Geotextile-Reinforced MSE Wall

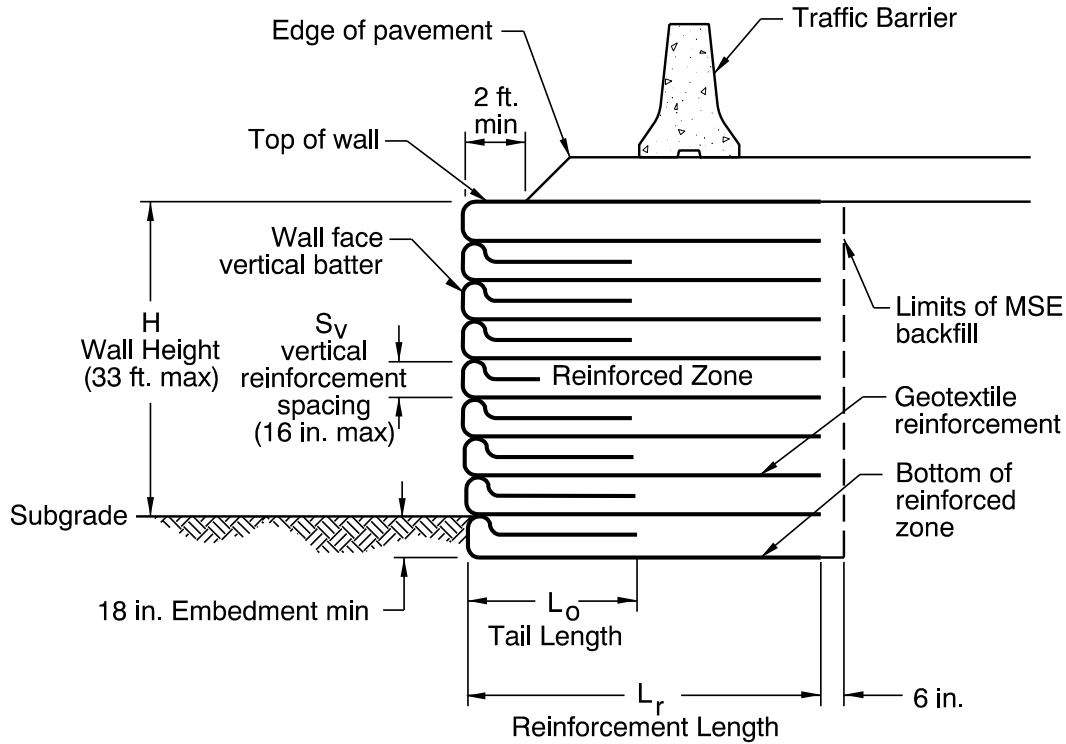

SECTION VIEW

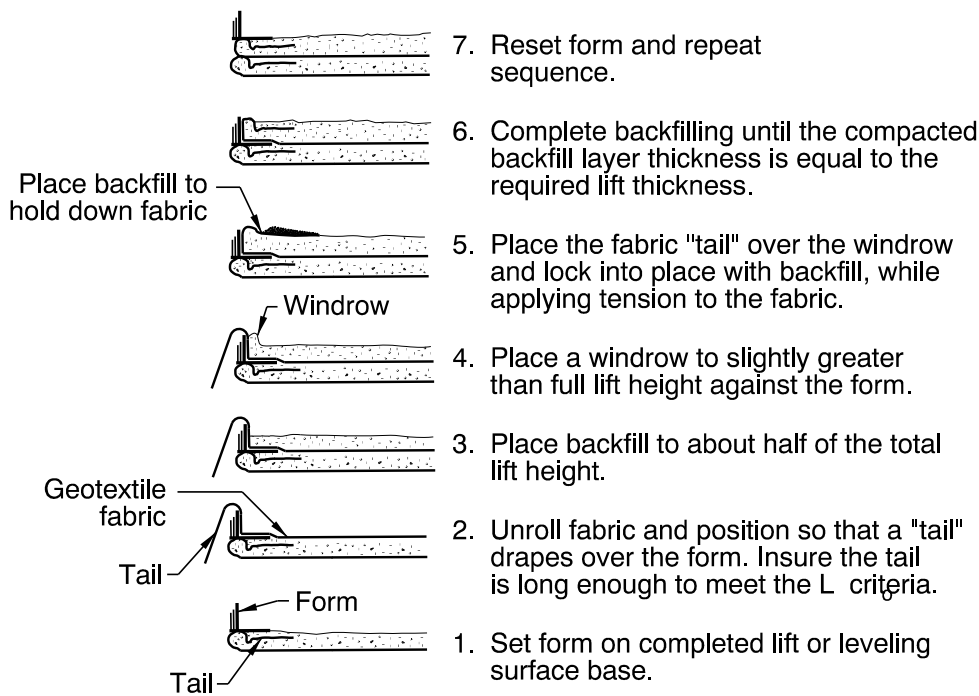

WRAPPED-FACE WALL CONSTRUCTION PROCEDURE

Note if welded wire mesh forms are used they may also be left in place for ease of construction and improved facing alignment of temporary wrapped-face geotextile - reinforced MSE walls.

Temporary geotextile walls are typically used for detours, bridge construction staging, and roadway widening. These walls are relatively low cost and use lightweight materials. Construction is relatively rapid and does not require specialized labor or equipment. As indicated in [Section 16.3.15](#), geotextile wrapped-face MSE walls can tolerate relatively large magnitudes of settlement without significant damage.

Design requirements presented below assume temporary geotextile walls support roadway construction that is relatively settlement-tolerant, such as guardrail, ditches, traffic barrier, and flexible pavements. Temporary walls supporting relatively settlement-sensitive structures, such as bridges, sound walls, retaining walls, critical utilities, and buildings, for which the consequences of excessive foundation movement, adverse performance or failure are severe, shall be designed for the level of safety and/or performance consistent with permanent construction in accordance with the *AASHTO LRFD Bridge Design Specifications* and the *ODOT Geotechnical Design Manual (GDM)*.

### 16.6.16.1 Design Requirements

Temporary geotextile-reinforced MSE retaining walls shall be designed in accordance with the requirements in Division I, Section 5 of the *AASHTO Standard Specifications for Highway Bridges*, 17<sup>th</sup> Edition (2002) for allowable stress design or the *AASHTO LRFD Bridge Design Specifications*. Design shall be in compliance with the ODOT GDM. In case of conflict or discrepancy between these design specifications and manuals, the GDM shall govern. The following additional design requirements apply to temporary geotextile-reinforced MSE walls:

1. Design temporary geotextile-reinforced MSE walls for the period of the project construction, or a service life of three years, whichever is greater. Walls remaining in service for more than 3 years shall be designed as permanent MSE walls.
2. Design geotextile reinforcement for temporary walls using Total Reduction Factor (RF) values from Table 11.10.6.4.3b-1 in the *AASHTO LRFD Bridge Design Specifications*.
3. Design of temporary geotextile-reinforced MSE walls with construction penetrating the wall (i.e. utilities, drainage pipes and culverts) shall explicitly consider local internal and external wall stability effects from the penetration. Design temporary geotextile walls with penetrations in accordance with the requirements of *Chapter 5 MSE Wall Details* in NHI-10-024 (FHWA, 2009). Provide project-specific plans and details showing modifications to MSE wall construction at the wall penetration(s).
4. The maximum wall height (H) shall not exceed 33 ft. ([Figure 16-8](#)).
5. The minimum wall reinforcement length ( $L_r$  shown in [Figure 16-8](#)) shall be the greater dimension of the following:
  - 70 percent of the total wall height (H) in accordance with AASHTO Article 11.10.2.1;
  - 8.0 ft. in accordance with AASHTO Article 11.10.2.1; or
  - The minimum reinforcement length required to meet all external, internal, and overall (global) stability requirements.

6. Temporary geotextile walls shall have uniformly spaced, horizontal geotextile reinforcement layers from wall bottom to top as indicated in [Figure 16-8](#). The geotextile reinforcement vertical spacing ( $S_v$ ) shall not exceed 16in between adjacent layers.
7. Fill construction along the top of temporary geotextile-reinforced MSE walls shall be set back a horizontal distance of at least distance 2.0ft from the top of the wall as indicated in [Figure 16-8](#).
8. Calculate the lateral stress  $\sigma_h$  (max) and associated geotextile reinforcement loads for temporary geotextile wall internal stability design using the Simplified Method in accordance with AASHTO Article 11.10.6.2.1.
9. Internal and external stability design of temporary geotextile walls shall be performed using the most current versions and updates of the computer programs MSEW and ReSSA® (ADAMA Engineering, Inc.). Wall sliding (external stability consideration) frequently controls the minimum required wall reinforcement length ( $L_r$ ).
10. Design submittal and construction drawings shall indicate design geotechnical properties assumed for the reinforced MSE backfill, wall backfill and/or backcut materials, and wall foundation soils. Also provide the following information: design minimum and maximum groundwater levels; type, size, and location of wall subdrainage system(s); geotextile reinforcement properties; assumed location and magnitude of wall surcharge and fill; live and dead loads assumed in internal and external stability design.
11. External, internal and global (overall) stability design shall evaluate all applicable limit states in accordance with *AASHTO LRFD* during construction and over the design service life of the temporary geotextile wall. External, internal and global stability design shall consider potential impacts on the wall stability, including:
  - Loss of ground support in front or adjacent to the temporary wall from excavation or any construction activity;
  - High point load or surcharge from the operation of heavy construction equipment operation or material storage within a horizontal distance H from the wall ( $H$  = wall height);
  - Effects of full hydrostatic pressures and seepage forces on wall;
  - Damage or removal of geotextile reinforcement layers from construction activities; and
  - Damage or removal of portions or all geotextile walls facing from vandalism, vehicle impact, debris impact, fire, and/or other reason.
12. Global stability design shall include investigation of compound and overall shear failure surfaces that penetrate the MSE wall reinforced backfill, cover fill, backfill or backcut, and/or foundation soils. Global (overall) stability design shall be performed using any state-of-the-practice computer program, such as the most current versions of Slope/W® (Geo-Slope International), or ReSSA® (ADAMA Engineering, Inc.).
13. Evaluation of sliding resistance (external stability) shall neglect any contribution from passive earth pressure resistance provided by embedment of temporary geotextile walls.
14. Calculate foundation bearing capacity and settlement of geotextile-reinforced MSE walls in accordance with Chapter 10 of *AASHTO LRFD* and the *ODOT GDM*. Design ground

improvement for temporary geotextile wall construction, as needed, to mitigate inadequate foundation support conditions.

## 16.7 Prefabricated Modular Walls

Prefabricated modular walls without soil reinforcement, such as metal and precast concrete bins, precast concrete cribs, dry cast concrete blocks, wet cast concrete blocks, and gabions shall be considered prefabricated modular walls. Design prefabricated modular walls as gravity retaining structures in accordance with *AASHTO LRFD* and the *ODOT GDM*.

Design prefabricated modular gravity walls for seismic design forces in accordance with *AASHTO LRFD* Articles 11.6.5 and 11.11.6, [Section 16.3.13](#), and the following recommendations:

- Prefabricated modular wall seismic design shall include global (overall), external (i.e., sliding, overturning, and bearing), and internal stability analyses.
- Global and external stability checks need to consider failure surfaces that pass through the wall section at joints and significant changes in wall cross-sectional geometry - as well as surfaces passing below the wall base. Stability checks should include the additional shear resistance from the structural interlocking that occurs along joints between modular wall components.
- Check wall sliding, overturning, and toppling stability for modular walls along and above joints between wall elements, especially at significant changes in wall cross-section for stacked and/or multi-depth walls.

Prefabricated modular walls shall not be used as a Bridge Abutment or Bridge Retaining Wall unless designed to meet the seismic design performance requirements in accordance with [Chapter 7](#).

### 16.7.1 Metal and Precast Concrete Bin Retaining Walls

#### 16.7.1.1 General Considerations

Metal and precast concrete bin retaining walls are typically rectangular, interlocking, prefabricated concrete modules or bolted lightweight steel members stacked like boxes to form retaining walls. The bin wall modules are filled with well-graded, compacted gravel (crushed rock) to create heavy gravity structures with sufficient mass to resist overturning and sliding forces. Metal and concrete bin walls come in a variety of dimensions.

#### 16.7.1.2 Geotechnical Investigation

Design of metal and precast concrete bin walls requires a geotechnical investigation to explore, sample, characterize and test the wall foundation soils and measure site groundwater levels. Geotechnical investigation requirements are outlined in [Chapter 4](#).



### 16.7.1.3 Wall Selection Criteria

Metal bin walls are subject to corrosion damage from exposure to aggressive surface water runoff, infiltration or seepage typically associated with snow/ice removal or marine environment zones see [Section 16.3.21](#), or potentially from exposure to aggressive backfill materials, in-place soils along wall backcuts, or in-place foundation soil or rock. Open-faced bin walls are subject to damage from erosion (backfill loss through face) where the wall face is exposed to flowing water, excessive hydrostatic pressures and/or seepage forces.

### 16.7.1.4 Layout and Geometry

The wall base width of bin walls shall not be less than 3.0 ft. An additional horizontal easement is required behind the wall to accommodate the wall backcut. Bin walls are not recommended for applications that require a radius of curvature less than 800ft. The wall face batter shall not be steeper than 10° or 6v:1h.

### 16.7.1.5 Design Requirements

1. Metal and precast concrete bin retaining walls shall be designed in accordance with the *AASHTO LRFD Bridge Design Specifications* and the *ODOT GDM*.
2. The minimum wall embedment depth shall meet all requirements in *AASHTO LRFD* and the *ODOT GDM*.
3. Wall backfill slopes shall be no steeper than 1v:2h.
4. Where practical, a minimum 4.0ft wide horizontal bench shall be provided in front of walls.
5. Unless otherwise noted, external and internal stability analysis and design of metal and precast concrete bin retaining walls shall assume the following geotechnical properties for bin module fill and wall backfill:
  - Friction angle of backfill:  $\phi = 34^\circ$ ;
  - Backfill cohesion:  $c = 0$  psf; and
  - Backfill moist unit weight ( $\gamma_{wet}$ ) = 120 pcf.

### 16.7.1.6 External Stability Analysis

Active earth pressures shall be calculated using Coulomb earth pressure theory in accordance with *AASHTO LRFD*. Lateral earth pressures shall be calculated in accordance with *AASHTO* Articles 3.11.5.3 and 3.11.5.9. Apply calculated lateral earth pressure along the back of bin walls in accordance with *AASHTO* Article 3.11.5.9 (Figures 3.11.5.9-1 and 3.11.5.9-2).

Calculate the lateral active earth pressure thrust on metal and precast concrete bin retaining walls with a broken backslope, point load(s) or surcharge(s), groundwater effects, and/or with a non-uniform soil (backfill) profile, using the Culmann or Trial Wedge methods such as presented in *Soil Mechanics in Engineering Practice* (Terzaghi and Peck, 1967) or *NAVFAC DM-7.01* and *DM-7.02* (U.S. Navy, 1982).

Bin walls require a properly designed subdrainage system in accordance with AASHTO Article 11.11.8 and [Section 16.3.18](#), including a drainage geotextile layer along the backside of metal and precast concrete bin walls to prevent the intrusion of fine-grained soil into or through the bin modules.

External stability analysis shall include sliding, overturning, soil bearing resistance, settlement, and overall (global) stability based on the applicable *AASHTO LRFD* load factor combinations and resistance factors. Additionally, evaluate bin wall sliding and overturning stability at each module level of the wall. The wall base may be slightly sloped into the backfill to improve overturning stability in accordance with AASHTO Article 3.11.5.9.

Calculate sliding lateral resistance in accordance with AASHTO Article 10.5.5.2.2 and Table 10.5.5.2.2-1.

The maximum eccentricity limits of the resultant force acting on the base shall meet the requirements of AASHTO Article 10.6.3.3. These requirements apply to each module level of the wall.

The effective footing dimensions of eccentrically loaded bin walls in overturning shall be evaluated in accordance with *AASHTO LRFD Specifications*. Design shall assume no greater than 80 percent of the weight of the bin module backfill is effective in resisting bin wall overturning forces in accordance with AASHTO Article 11.11.4.4. Soil bearing resistance design shall be in accordance with AASHTO Article 10.6.3.1.

The overall (global) stability shall be evaluated in accordance with AASHTO Article 11.6.2.3 and the *ODOT Geotechnical Design Manual (GDM)*, with the exception that the mass of the bin wall (or the “foundation load”), may be assumed to contribute to the overall stability of the slope.

External stability analysis shall also meet seismic design requirements in accordance with AASHTO Article 11.6.5 and [Chapter 7](#), [Chapter 15](#) and [Chapter 16](#).

## **16.7.2 Precast Concrete Crib Retaining Walls**

### **16.7.2.1 General Considerations**

Precast concrete crib walls are interlocking, concrete stretcher and header elements cross-stacked to form rectangular modules. The front and rear stretchers form the front and rear sides of the wall with headers placed transverse to the stretcher units. Crib wall modules are filled with well-graded, compacted gravel (crushed rock) backfill to create a gravity wall with sufficient mass to resist overturning and sliding forces. Precast concrete crib walls come in a variety of dimensions.

### **16.7.2.2 Geotechnical Investigation**

Design of precast concrete crib walls requires a geotechnical investigation to explore, sample, characterize and test the wall foundation soils and measure site groundwater levels.

Geotechnical investigation requirements are outlined in [Chapter 4](#).

### 16.7.2.3 Wall Selection Criteria

Open-faced crib walls are subject to damage from loss of backfill materials through the face and developing root systems that can cause uplift, cracking or separation of bin modules. Open-faced crib walls are also subject to damage from erosion (backfill loss through face) where the wall face is exposed to flowing water, excessive hydrostatic pressures and/or seepage forces.

### 16.7.2.4 Layout and Geometry

The crib wall base width shall not be less than 3.0 ft. An additional horizontal easement is required behind the wall to accommodate the wall backcut. Crib walls are not recommended for applications that require a radius of curvature less than 800 ft. The wall face batter shall not be steeper than 4v:1h.

### 16.7.2.5 Design Requirements

1. Precast concrete crib retaining walls shall be designed in accordance with the *AASHTO LRFD Bridge Design Specifications* and the *ODOT GDM*. Minimum wall embedment depth shall meet all requirements in *AASHTO LRFD*.
2. Wall backfill slopes shall be no steeper than 1v:2h.
3. Where practical, a minimum 4.0-ft-wide horizontal bench shall be provided in front of wall
4. Precast concrete bin retaining walls shall meet all seismic design requirements in *AASHTO LRFD* and the *ODOT GDM*.
5. Unless otherwise noted, external and internal stability analysis and design of precast concrete crib retaining walls shall assume the following geotechnical properties for crib module fill and wall backfill:
  - Friction angle of backfill:  $\phi = 34^\circ$ ;
  - Backfill cohesion:  $c = 0$  psf; and
  - Backfill moist unit weight ( $\gamma_{wet}$ ) = 120 pcf

### 16.7.2.6 External Stability Analysis

Active earth pressures for single-cell crib walls shall be calculated using Coulomb earth pressure theory in accordance with *AASHTO LRFD*, and Rankine earth pressure theory shall be used for multi-depth walls. Lateral earth pressures shall be calculated in accordance with *AASHTO* Article 3.11.5.3 and 3.11.5.9. Apply calculated lateral earth pressure along the back of crib walls in accordance with *AASHTO* Article 3.11.5.9 (Figures 3.11.5.9-1 and 3.11.5.9-2). Use maximum wall friction angles in Table C3.11.5.9-1.

Crib walls require a properly designed subdrainage system in accordance with [Section 15.3.18](#), including a drainage geotextile layer along the back stretcher and end header units of crib walls to prevent fine-grained soil intrusion into or through the modules.

External stability analysis shall include sliding, overturning, soil bearing resistance, settlement, and overall (global) stability based on the applicable LRFD load factor combinations and resistance factors.

The maximum eccentricity limits of the resultant force acting on the crib wall base shall meet the requirements of AASHTO Article 10.6.3.3. These requirements apply to each module level of the wall.

Check crib wall sliding stability along the following potential failure planes:

- Interface between foundation base (gravel or concrete leveling pad) and the subsoil;
- Between lowest crib base stretcher and header elements and the leveling pad; and
- Within the crib structure (including all changes in wall section for multi-depth walls).

Ignore benefit from lugs, interlocking dowels, or other crib wall modifications when assessing sliding resistance between crib elements.

In sliding, lateral resistance shall neglect any contribution from passive earth pressure resistance.

Check crib wall sliding and overturning stability at the following points:

- Toe of the crib wall (stretcher or header);
- Toe of the rigid concrete leveling pad (crib wall foundation) below the crib wall; and
- Any joint between crib wall elements at the wall face—including changes in wall section for multi-depth walls.

Check crib wall for toppling failure above joints between crib wall elements—including changes in wall section for multi-depth walls.

The wall base may be slightly sloped into the backfill to improve overturning stability in accordance with AASHTO Article 3.11.5.9.

The effective footing dimensions of eccentricity loaded crib walls in overturning shall be evaluated in accordance with *AASHTO LRFD Specifications*. Design shall assume no greater than 80 percent of the weight of the crib module backfill is effective in resisting crib wall overturning forces in accordance with AASHTO Article 11.11.4.4. Soil bearing resistance design shall be in accordance with AASHTO Article 10.6.3.1.

The overall (global) stability shall be evaluated in accordance with AASHTO Article 11.6.2.3 and the ODOT GDM—with the exception that the mass of the crib wall (or the “foundation load”) may be assumed to contribute to the overall stability of the slope.

### **16.7.2.7 Internal Stability Analysis**

Design crib wall headers and stretchers as beams with fixed ends supported at their intersections and subjected to loads and pressures from the module fill, wall backfill, and base reactions. Design shall consider any potential failure mode, including tension, compression, shear, bending, and torsion.

Crib wall members shall be designed for lateral pressures as indicated on Figure 5.10.4.1-1 in *Section 5 - Retaining Walls, Bridge Design Specifications* (Caltrans, 2004). Design forces on front, intermediate and rear stretchers, headers and base members shall be in accordance with Figure 5.10.4.1-1 through 6.

## **16.7.3 Gabion Walls**

### **16.7.3.1 General Considerations**

Gabion walls consist of heavy wire mesh baskets filled with hard, durable stone to form rectangular modules referred to as gabion baskets. The standard ODOT gabion basket unit has a depth, height and length of 36 in.

Gabion walls are typically less than 18 ft. in height and are designed as gravity structures in accordance with *AASHTO LRFD*.

### **16.7.3.2 Geotechnical Investigation**

Design of gabion walls requires a geotechnical investigation to explore, sample, characterize and test the wall foundation soils and the adjacent ground conditions. Geotechnical investigation requirements are outlined in [Chapter 4](#).

### **16.7.3.3 Wall Selection Criteria**

Gabion walls are vulnerable to corrosion damage from aggressive foundation soils and backfill and where runoff, stream or river water is acidic or aggressive. Gabions are also vulnerable to damage due to abrasion from rock impacts and debris in flowing water.

Gabion baskets are subject to corrosion damage from exposure to aggressive surface water runoff, infiltration or seepage typically associated with snow/ice removal or marine environment zones see [Section 15.3.21](#), or potentially from exposure to aggressive in-place soils along wall backcut or foundation areas. Corrosion protection for gabion baskets typically requires the use of stainless steel materials or galvanized metal materials with polyvinyl chloride (PVC) coating. Epoxy coating of gabion baskets is not recommended as the primary method of corrosion protection due to limited design life. Project specific conditions should be evaluated to determine the required level of corrosion protection for gabion basket walls.

Gabions are most economical if there is a local source of suitable stone for basket fill. Gabion walls are well suited for developing vegetation cover.

Gabion walls are relatively free draining and well suited for stream and riverbank applications. A drainage geotextile layer is typically required behind between gabion modules and the surrounding backfill and foundation soil to prevent the intrusion of finer-grained soil particles through the open stone gabion basket fill.

### 16.7.3.4 Layout and Geometry

The wall base width shall not be less than 3.0 ft. An additional horizontal easement is required behind the wall to accommodate the backcut. The wall face batter shall not be steeper than 6° or 10v:1h.

### 16.7.3.5 Design Requirements

1. Gabion walls shall be designed as gravity structures in accordance with *the AASHTO LRFD Bridge Design Specifications* and the *ODOT Geotechnical Design Manual (GDM)*.
2. Wall backfill slopes shall be no steeper than 1v:2h.
3. Where practical, a minimum 4.0 ft. wide horizontal bench shall be provided in front of walls.
4. Gabion baskets shall be arranged so vertical seams are staggered and not aligned. The gabion steel wire mesh material shall have adequate strength, flexibility, and durability for the project site conditions and intended use. Gabion walls shall meet all seismic design requirements in accordance with the *AASHTO LRFD* and the *ODOT GDM*.
5. To prevent internal erosion and excessive migration of soil particles through the gabion units, place drainage geotextile filter (or drainage geotextile) layers around portions of gabion units in contact with soil.

### 16.7.3.6 External Stability Analysis

Active earth pressures for gabion wall design shall be calculated using Coulomb earth pressure theory in accordance with *AASHTO LRFD Specifications*. Lateral earth pressures shall be calculated in accordance with AASHTO Article 3.11.5.3 and 3.11.5.9.

Apply calculated lateral earth pressure along the back of gabion walls in accordance with AASHTO Article 3.11.5.9 (Figures 3.11.5.9-1 and 2). Use maximum wall friction angles in Table C3.11.5.9-1. Groundwater conditions creating unbalanced hydrostatic pressures shall be considered in external stability analysis.

Unless otherwise noted, gabion wall analysis and design shall assume the following geotechnical properties for the wall backfill:

- Friction angle of backfill:  $\phi = 34^\circ$ ;
- Backfill cohesion:  $c=0$  psf; and
- Backfill moist unit weight ( $\gamma_{wet}$ ) = 125 pcf.

The wall face batter shall not be steeper than 10v:1h to maintain the resultant wall force towards the back of the wall.

Calculate lateral sliding resistance in accordance with AASHTO Article 10.5.5.2.2 (Table 10.5.5.2.2-1).

In sliding, lateral resistance shall neglect any contribution from passive earth pressure resistance.

Provide durable, 4- to 8-in.-diameter rock fill material for gabion baskets meeting the requirements of 00390.11(b). Gabion basket material shall consist of suitable rock materials (i.e. Basalt, Sandstone, or Granite) meeting the requirements of Section 00390 (Riprap Protection), except suitable rounded rock material is permitted.

Unless project specific data are available, external stability analyses shall assume the rock-filled gabion baskets have a bulk density (total unit weight) of 100 pcf for material and basket filling per Standard Specification 00596B. Table 16-10 presents basalt gabion basket fill density relative to filled gabion basket porosity.

**Table 16-10 In-Place Porosity vs. Bulk Density, Gabion Basket Rock Fill**

Rock Type	Rock Specific Density (pcf)	Gabion Basket Rock Fill Porosity (n) <sup>4</sup>		
		n = 0.30	n = 0.35	n = 0.40
Basalt	170.0	119.0	110.5	102.0

Rock filled gabion baskets require a properly designed geotextile filter fabric material to prevent the intrusion of fine-grained soil into the stone filled baskets.

External stability analysis shall include sliding, overturning, soil bearing resistance, settlement, and overall (global) stability based on the applicable LRFD load factor combinations and resistance factors.

Soil bearing resistance design shall be in accordance with *AASHTO LRFD* and the *ODOT GDM*. Calculate foundation settlement in accordance with *AASHTO* Article 10.6.2.4.

The overall (global) stability shall be evaluated in accordance with *AASHTO* Article 11.6.2.3 and the *ODOT GDM*. The mass of the gabion wall (or the “foundation load”) may be assumed to contribute to the overall stability of the slope.

## **16.7.4 Dry Cast Concrete Block Gravity Walls**

### **16.7.4.1 General Considerations**

Dry cast concrete block gravity retaining walls consist of a single row of dry stacked blocks (without mortar) that resist overturning, base sliding, and shear forces through self-weight of

---

<sup>4</sup> The in-place bulk density ( $\gamma_g$ ) is calculated from rock specific density ( $\gamma_s$ ) and in-place porosity (n) based on the following relationship:  $\gamma_g = \gamma_s * (1-n)$ .

the blocks and the retained backfill. Design of dry cast concrete block gravity retaining walls shall be performed in accordance with the *AASHTO LRFD Bridge Design Specifications*.

### **16.7.4.2 Geotechnical Investigation**

Design of dry cast concrete block gravity retaining walls requires a geotechnical investigation to explore, sample, characterize and test foundation soils and measure groundwater levels.

Geotechnical investigation requirements for wall foundation design are outlined in [Chapter 4](#).

### **16.7.4.3 Wall Selection Criteria**

The decision to select a dry cast concrete block gravity retaining wall should be based on project specific criteria. This decision should consider the general wall design requirements contained in [Section 16.3](#). Dry cast concrete block gravity retaining walls can be formed to a tight radius of curvature of 10 ft or greater see [Section 16.3.4](#).

Dry cast concrete block gravity retaining walls shall only be considered if used in conjunction with properly designed surface water drainage facilities and a subdrainage system see [Section 16.3.18](#) that prevents surface water runoff or groundwater seepage contact with the dry cast concrete face and maintains groundwater levels below the base of the wall.

### **16.7.4.4 Wall Height, Footprint and Construction Easement**

Dry cast concrete block gravity walls are typically designed to a maximum height of 10 ft. Dry cast concrete block gravity retaining walls typically require an additional lateral construction easement of at least  $1.5 \cdot H$  ( $H$  = wall height) behind the wall heel to accommodate open-cut construction, drainage installation, backfill placement and compaction behind the wall. A lateral easement restriction and/or the presence of an existing roadway, structure, or utility within the construction limits could require shoring, underpinning and/or right-of-way acquisitions that can affect the construction budget and/or schedule.

### **16.7.4.5 Design Requirements**

1. Dry cast concrete block gravity retaining walls shall include adequate subdrainage, including drainage blankets, chimney drains, and/or perforated collector pipes to relieve hydrostatic pressures and seepage forces on walls in accordance with [Section 16.3.18](#). Additionally, provide adequate surface drainage facilities, including ditches, gutters, curbs and drop inlets, to intercept and direct water towards suitable discharge locations as described below.
2. Dry cast gravity retaining walls shall have backfill slopes no steeper than 1v:2h.
3. Where practical, a minimum 4.0 ft.-wide horizontal bench shall be provided in front of dry cast gravity walls.
4. The dry cast wall subdrainage system and surface drainage facilities shall prevent surface water runoff or groundwater seepage contact with the dry cast concrete face and maintain groundwater levels below the base of the wall.



5. Assess internal stability, external stability (soil bearing resistance, settlement, eccentricity and sliding), and overall (global) slope stability for dry cast concrete block gravity retaining walls in accordance with the *AASHTO LRFD Bridge Design Specifications* and the *ODOT Geotechnical Design Manual (GDM)*.
6. Active earth pressures acting on dry cast concrete block gravity retaining walls should be calculated using Coulomb earth pressure theory in accordance with AASHTO Article 3.11.5.3 and [Section 16.3.10](#).
7. Calculate the lateral active earth pressure thrust on dry cast concrete block walls with a broken backslope, point load(s) or surcharge(s), groundwater effects, and/or with a non-uniform soil or backfill profile using the *Culmann* or *Trial Wedge* methods.
8. Unless otherwise noted, dry cast concrete block gravity wall analysis and design shall assume the following geotechnical properties for the wall backfill:
  - Friction angle of backfill:  $\phi = 34^\circ$ ;
  - Backfill cohesion:  $c = 0$  psf;
  - Backfill moist unit weight ( $\gamma_{wet}$ ) = 125 pcf; and
  - Friction angle of gravel leveling pad fill:  $\phi = 34^\circ$ .
9. Internal sliding stability shall be checked at each dry cast concrete block level from the lowest block to the top of wall. Dry cast facing must have sufficient interface shear capacity to transfer lateral loads to the base of the structure without excessive wall translation, bulging, or damage. Interface sliding resistance between dry cast concrete blocks shall be calculated using the corrected wall weight based on the calculated hinge height in accordance with AASHTO Figure and Equation 11.10.6.4.4b-2. Dry cast block interface friction resistance parameters shall be based on product-specific data using NCMA Test Method SRWU-2 (Determination of Shear Strength between Segmental Concrete Units) in accordance with Appendix C.2 in NCMA (2002).
10. Calculate bearing resistance in accordance with AASHTO Article 10.6.3.1.
11. Calculate base sliding resistance (external stability) in accordance with AASHTO Article 10.6.3.4. Sliding resistance analysis shall address dry cast units bearing on gravel or on cast-in-place concrete leveling pads. The total vertical force used to calculate sliding resistance shall be corrected based on the corrected height of the dry cast column (hinge height) calculated in accordance with AASHTO Equation 11.10.6.4.4b-2. The calculated hinge height shall not exceed the wall height.
12. In sliding, lateral resistance shall neglect any contribution from passive earth pressure resistance.

## 16.7.5 Wet Cast Concrete Block Gravity Walls

### 16.7.5.1 General Considerations

Wet cast concrete block gravity retaining walls consist of a single row or multiple rows of stacked concrete blocks that resist overturning, base sliding, and shear forces through self-weight of the blocks and the retained backfill. Design of wet cast concrete block gravity

retaining walls in accordance with the *AASHTO LRFD Bridge Design Specifications* and the *ODOT Geotechnical Design Manual (GDM)*.

### **16.7.5.2 Geotechnical Investigation**

Design of wet cast concrete block gravity retaining walls requires a geotechnical investigation to explore, sample, characterize and test foundation soils and measure groundwater levels.

Geotechnical investigation requirements for wall foundation design are outlined in [Chapter 4](#).

### **16.7.5.3 Wall Selection Criteria**

The decision to select a wet cast concrete block gravity retaining wall should be based on project specific criteria. This decision should consider the general wall design and performance requirements contained in [Section 16.3](#) and in the Oregon Standards Specifications for Construction.

### **16.7.5.4 Wall Height, Footprint and Construction Easement**

Wet cast concrete block gravity walls are typically designed to a maximum height of 15 ft. Wet cast concrete block gravity retaining walls typically require an additional lateral construction easement of at least  $1.5 \cdot H$  ( $H$  = wall height) behind the wall heel to accommodate open-cut construction, drainage installation, backfill placement and compaction behind the wall. A lateral easement restriction and/or the presence of an existing roadway, structure, or utility within the construction limits could require shoring, underpinning and/or right-of-way acquisitions that can affect the construction budget and/or schedule.

### **16.7.5.5 Design Requirements**

1. Wet cast concrete block gravity retaining walls shall include adequate subdrainage, including drainage blankets, chimney drains, and/or perforated collector pipes to relieve hydrostatic pressures and seepage forces on walls in accordance with [Section 16.3.18](#). Additionally, provide adequate surface drainage facilities, including ditches, gutters, curbs and drop inlets, to intercept and direct water towards suitable discharge locations. Follow these guidelines:
2. Wet cast gravity retaining walls shall have backfill slopes no steeper than 1v:2h.
3. Where practical, a minimum 4.0-ft-wide horizontal bench shall be provided in front of wet cast gravity walls.
4. Assess internal stability, external stability (soil bearing resistance, settlement, eccentricity and sliding), and overall (global) slope stability for wet cast concrete block gravity retaining walls in accordance with the *AASHTO LRFD Bridge Design Specifications* and the *ODOT GDM*.
5. Active earth pressures acting on wet cast concrete block gravity retaining walls should be calculated using Coulomb earth pressure theory in accordance with AASHTO Article 3.11.5.3 and [Section 16.3.10](#).

6. Unless otherwise noted, wet cast concrete block gravity wall analysis and design shall assume the following geotechnical properties for the wall backfill:
  - Friction angle of backfill:  $\phi = 34^\circ$ ;
  - Backfill cohesion:  $c = 0$  psf;
  - Backfill moist unit weight ( $\gamma_{\text{wet}}$ ) = 125 pcf; and
  - Friction angle of gravel leveling pad fill:  $\phi = 34^\circ$ .
7. Internal sliding stability shall be checked at each wet cast concrete block level from the lowest block to the top of wall. Wet cast facing must have sufficient interface shear capacity to transfer lateral loads to the base of the structure without excessive wall translation, bulging, or damage. Interface sliding resistance between wet cast concrete blocks shall be calculated using the corrected wall weight based on the calculated hinge height in accordance with AASHTO Figure 11.10.6.4.4b-1 and Equation 11.10.6.4.4b-2. Wet cast block interface friction resistance parameters shall be based on product-specific data using NCMA Test Method SRWU-2 (*Determination of Shear Strength between Segmental Concrete Units*) in accordance with Appendix C.2 in NCMA (2002).
8. Calculate bearing resistance in accordance with AASHTO Article 10.6.3.
9. Calculate base sliding resistance (external stability) in accordance with AASHTO Article 10.6.3.4. Sliding resistance analysis shall address wet cast units bearing on gravel or on cast-in-place concrete leveling pads. The total vertical force used to calculate sliding resistance shall be based on the corrected height of the wet cast column (hinge height) calculated in accordance with AASHTO Equation 11.10.6.4.4b-2. The calculated hinge height shall not exceed the wall height.
10. In sliding, lateral resistance shall neglect any contribution from passive earth pressure resistance.

## 16.8 Non-Gravity (Cantilever) Soldier Pile/Lagging and Sheet Pile Walls

### 16.8.1 General Considerations

Non-gravity (cantilever) soldier pile/lagging and sheet pile walls are typically used in temporary construction applications, but can also be used as permanent retaining walls. These wall systems are typically limited to a maximum height ( $H_w$ ) of 15 ft. or less due to inadequate stability, overstress of wall elements, and/or excessive lateral and vertical ground movements behind the wall caused by wall rotation and/or translation ( $H_w$  shown in [Figure 16-9](#)). Greater wall heights can be achieved using ground anchors or deadmen [Section 16.9](#) and [Section 16.10](#).

Figure 16-8 Non-Gravity (Cantilever) Soldier Pile and Sheet Pile Wall Heights

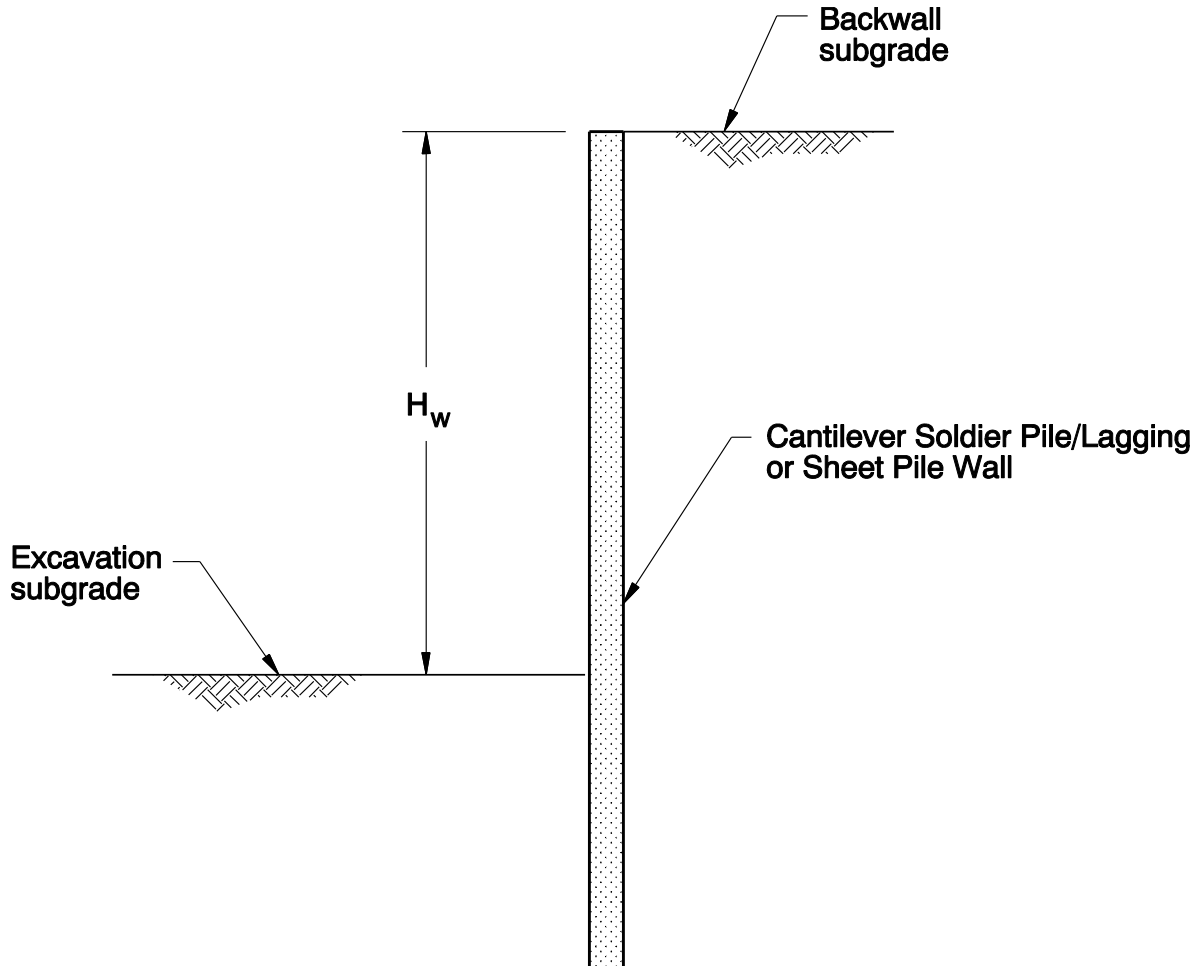

**Note:**

$H_w$  = Wall Height

## 16.8.2 Design Requirements

Design of non-gravity (cantilever) soldier pile/lagging and sheet pile walls shall be in accordance with AASHTO Article 11.8.

Design of soldier pile/lagging and sheet pile walls requires a detailed geotechnical investigation to explore, sample, characterize and test the retained soils and the foundation soils along each wall. Geotechnical investigation requirements are outlined in [Chapter 4](#). At a minimum, the geotechnical information required for wall design includes SPT N-values (depth intervals of 5 ft., or less), soil profile, unit weight, natural water content, Atterberg limit, sieve analysis, pH,

resistivity, organic content, chloride and sulfate concentrations, shear strength, consolidation parameters, foreslope and backslope inclinations, and groundwater levels.

Corrosion protection for soldier piles, sheet piles, connections, and other wall components should be consistent with the design life of the wall.

### **16.8.3 Soldier Pile/Lagging Walls**

Soldier pile walls shall be designed in accordance with AASHTO Article 11.8, *Geotechnical Engineering Circular No. 4 – Ground Anchors and Anchorage Systems* (FHWA, 1999), the *ODOT Geotechnical Design Manual (GDM)*, and the *ODOT Bridge Design Manual (BDM)*.

Soldier pile walls are used for both temporary and permanent applications. Soldier pile walls use wide flange steel members such as W or HP shapes. Built-up, double-channel shapes are also used as soldier piles. The spacing between soldier piles is typically 6 to 10 ft. (center-to-center). Lagging members (timber, reinforced concrete, shotcrete, and/or steel plates) span between the soldier piles to provide soil retention as wall excavation proceeds (top-down construction). Cantilever soldier pile wall heights ( $H_w$  in [Figure 16.9](#) in excess of 15 ft. are usually feasible using ground anchors, tiebacks or deadmen anchors.

Soldier pile/lagging walls are frequently used for temporary shoring in cut applications. Impact or vibratory methods may be used to install temporary soldier piles, but installation in drill holes is typically recommended.

Permanent soldier piles (typically HP or wide flange sections) for soldier pile/lagging walls and anchored walls should be installed in drilled holes backfilled with Controlled Low Strength Material or CSLM (Section 00442), grout, and/or concrete.

### **16.8.4 Sheet Pile Walls**

Sheet pile walls shall be designed in accordance with AASHTO Article 11.8, *Geotechnical Engineering Circular No. 4 – Ground Anchors and Anchorage Systems* (FHWA, 1999), the *ODOT Geotechnical Design Manual (GDM)*, the *USS Sheet Piling Design Manual* (United States Steel, 1984), and the *ODOT Bridge Design Manual (BDM)*.

Interlocking Z-type piles are typically used for sheet pile walls. Sheet pile walls are used for both temporary and permanent applications, including excavations, bulkhead walls, cofferdams and trenches. Cantilever sheet pile walls are relatively flexible and may not be well suited for areas with strict ground movement criteria.

Cantilever sheet pile wall heights ( $H_w$ ) in excess of 15 ft. can be achieved with the use of ground anchors or deadmen. Sheet pile wall embedment can be designed to reduce seepage forces and groundwater inflow into excavations and are well suited for foundation or trench excavations below the groundwater table, or as braced cofferdams below groundwater and in open water. Articulated sheet pile wall connections allow for a wide variety of irregular-shaped walls.

Sheet pile walls should not be used in areas with shallow bedrock or very dense and/or coarse soils (gravel, cobbles, or boulders), or where underground utilities, buried structures, debris or

other obstructions may exist. Sheet piles are typically installed using high-energy, vibratory pile hammers that can cause excavation slope failures or create damaging ground settlements and/or vibrations in a wide area around wall construction. Design of sheet pile walls shall include the consideration of construction vibration effects of sheet pile wall installation on adjacent features, including new concrete construction, steeper cuts/fills, underground utilities, shallow foundations, roadways, bridges or other structures.

The steel sheet pile section shall be designed for the anticipated corrosion loss during the design life of the wall.

If groundwater levels differ between the front and back of the wall, design shall consider the effects of the unbalanced, hydrostatic pressure and seepage forces on wall stability, including the potential for backfill piping through interlock joints or other perforations in the sheet pile wall. Design shall consider upward seepage forces that could create a critical seepage gradient (boiling condition) in front of the wall. Boiling conditions typically develop in cohesionless soils (coarse silts and sands) subject to critical seepage gradients caused by a high water head.

## **16.9 Anchored Soldier Pile/Lagging and Sheet Pile Walls**

### **16.9.1 General Considerations**

Soldier pile/lagging and sheet pile walls over 15 ft. in height typically require additional lateral resistance to maintain stability and/or limit wall movements. This lateral resistance can be provided using ground anchors or buried deadmen. For highway applications, anchored sheet pile walls are typically less than 33 ft. in height due to excessive top of wall deflections, excessive sheet pile bending stresses, and high stresses at the wall-anchor connection.

Anchor terminology, minimum anchor length and embedment guidelines are shown in AASHTO Figure 11.9.1-1. Anchor spacing is controlled by many factors including anchor (or deadmen) capacity, temporary (unsupported) cut slope stability, subsurface obstructions in the anchorage zone, and the structural capacity of lagging or facing elements. Performance or proof testing shall be performed on every production anchor in accordance with the requirements in [Section 15.10](#).

Excavation shall not proceed more than 3.0 ft. below the level of ground anchors until the ground anchors have been accepted by the Engineer.

Where backfill is placed behind an anchored wall, either above or around the unbonded length, special designs and construction specifications shall be provided to prevent anchor damage.

### **16.9.2 Design Requirements**

1. Anchored soldier pile/lagging and sheet pile wall designs shall evaluate the anticipated combinations of lateral earth pressures, hydrostatic pressures, and seepage forces, including rapid drawdown during construction dewatering. Walls shall either include a

properly designed subdrainage system to drain the retained earth or be designed for hydrostatic pressures and seepage forces in accordance with the *AASHTO LRFD Bridge Design Specifications*, FHWA (1999), and [Section 16.3.18](#).

2. Design anchored walls, constructed top down, using unfactored apparent earth pressure distributions described in AASHTO Article 3.11.5.7.
3. Calculate maximum ordinates of apparent earth pressure for cohesionless soils using Equation 3.11.5.7.1-1 (one row of anchors) and Equation 3.11.5.7.1-2 (multiple anchor levels).
4. Analyze overall (global) slope stability and settlement of non-gravity anchored walls in accordance with the *AASHTO LRFD Bridge Design Specifications* and the requirements of the *ODOT GDM*.
5. The influence of anchored wall movements shall be evaluated for all wall systems, especially walls located near settlement-sensitive structures, including bridge foundations, wingwalls, end-panels, traffic signals, pavements, utilities or developments near right-of-way boundaries.
6. Settlement of vertical wall elements can cause reduction of anchor loads and should be considered in design. A preliminary estimate of construction-phase ground settlement behind anchored walls can be made using AASHTO Figure C11.9.3.1-1, which does not include settlement caused by heavy construction surcharge loads, dewatering, foundation settlement, or poor construction practice, which must be estimated separately. Mitigation of excessive ground settlement is recommended.
7. The external and internal failure modes shall be analyzed for non-gravity anchored walls using the methodologies and procedures presented in *Geotechnical Engineering Circular No. 4 – Ground Anchors and Anchorage Systems* (FHWA, 1999). Typical internal, external and anchorage failure modes are presented in [Figure 16-10](#). Check stability along potential failure surfaces passing just behind ground anchors or buried deadmen, including failure surfaces that pass through the free length and/or bonded zones of ground anchors in the lower portion of the wall as shown in [Figure 16-10](#).
8. The elevation of the ground anchor closest to the backslope ground surface should be evaluated considering the allowable cantilever deformations of the wall. The uppermost anchor depth should also be selected to minimize the potential for exceeding the passive resistance of the retained soil during anchor proof or performance load testing.
9. Seismic design of anchored soldier pile/lagging and sheet pile walls shall be in accordance with AASHTO LRFD Articles 11.9.6.

Figure 16-9 Anchored Walls: External, Internal, Global and Facing Failure Modes

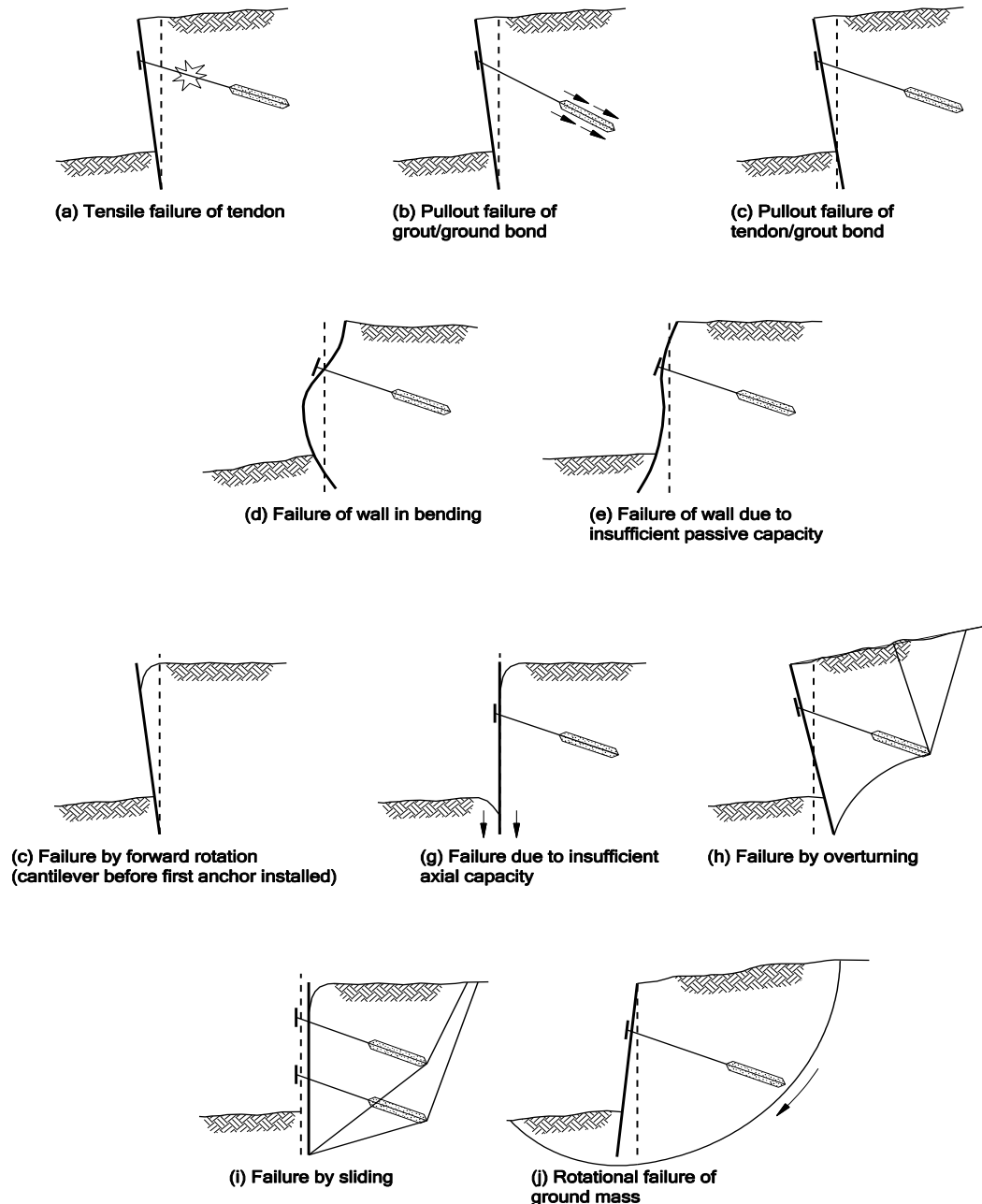

## 16.10 Ground Anchors, Deadmen, and Tie-Rods

### 16.10.1 General Considerations

Ground anchors are used for permanent and temporary retaining walls and slope or landslide stabilization systems. The design of ground anchors shall be in accordance with the following:

- *AASHTO LRFD Bridge Design Specifications*;
- *ODOT GDM*; and



- *Geotechnical Engineering Circular No. 4 - Ground Anchors and Anchorage Systems* (FHWA, 1999).

*Recommendations for Prestressed Rock and Soil Anchors*, (PTI, 2014) is another useful reference.

Design of ground anchors requires a detailed geotechnical investigation to explore, sample, characterize and test soil and rock conditions within and around the ground anchorage zone (ground anchors and deadmen). Additional geotechnical borings should be completed to explore soil and/or bedrock conditions within the bond zone of the anchors. The geotechnical investigation shall determine the depth, limits and failure surface geometry of any existing or potential sliding plane, slope failure, or landslide within, above, below, and/or adjacent to the anchors and deadmen.

Geotechnical investigation requirements are outlined in [Chapter 4](#). At a minimum, the geotechnical information required for ground anchorage design includes SPT N-values (depth intervals of 5 ft., or less), soil profile, unit weight, natural water content, Atterberg limit, soil corrosivity tests (e.g., pH, resistivity, organic content, chloride and sulfate concentrations), sieve analysis, shear strength, consolidation parameters, foreslope and backslope inclinations, and groundwater levels.

Conventional straight shaft, gravity-grouted ground anchors (bar tendons) are typically used. Ground anchors develop tensile (pullout) capacity from tendon-grout-ground bond stress along the anchor bond zone. Anchor capacity shall be determined based on the soil and rock conditions along the bonded anchor zone.

Highway retaining wall permanent ground anchors shall be designed for a minimum design life of 75 years. Bridge retaining wall permanent ground anchors shall be designed to have a design life consistent with the design life of the bridge—but not less than 75 years.

## 16.10.2 Anchor Location and Geometry

The geotechnical engineer shall define the no-load zone for anchors in accordance with *Geotechnical Engineering Circular No. 4 – Ground Anchors and Anchorage Systems* (FHWA, 1999) and AASHTO Article 11.9. The boundaries of the no-load zone limits shall be increased to include the failure surface of any existing or potential sliding plane, slope failure, or landslide. The unbonded anchor length shall extend a minimum distance of 5 ft. or  $0.2 \cdot H$  ( $H$  = design height shown in AASHTO Figure 11.9.1-1), whichever is greater, beyond the defined no load zone. Additionally, ground anchors should be located behind the failure surface associated with the seismic active earth pressure thrust ( $P_{AE}$ ) - determined in accordance with AASHTO Article 11.9.6.

Conventional gravity-grouted ground anchors shall have a minimum overburden depth of 15 ft. at the midpoint of the anchor bond zone. Ground anchors are typically installed at angles of 15 to 30° below the horizontal. Steeper anchor inclinations (45° max.) may be required to avoid underground utilities, adjacent foundations, right-of-way restraints, or unsuitable soil or rock layers and should not be installed at less than 10°.

### 16.10.3 Ground Anchor Design

Estimate the preliminary ground anchor bond resistance using the presumptive bond stress values in AASHTO Tables C11.9.4.2-1, -2, and -3, which address cohesive soils, cohesionless soils, and rock respectively. Designers should also consider the recommendations in *Geotechnical Engineering Circular No. 4 - Ground Anchors and Anchorage Systems* (FHWA, 1999) when selecting an anchor bond resistance. However, it is recommended that anchor bond stress be estimated from local ground anchor pullout test data, if available. The ground anchor bond stress is based on factors such as the consistency, density or strength of the soil and rock materials encountered within the ground anchorage zone, anchor overburden pressure, groundwater levels (hydrostatic pressures), and the anticipated ground anchor installation method and grouting pressure.

Lateral earth pressure loads on anchored walls shall be designed using the apparent earth pressure diagrams in AASHTO Article 3.11.5.7

### 16.10.4 Corrosion Protection

Protection of the metallic components of the tendon against corrosion is necessary to assure adequate long-term performance of the ground anchor. Three levels of corrosion protection are commonly specified: Class I, II and III corrosion systems are described and shown in *Geotechnical Engineering Circular No. 4 - Ground Anchors and Anchorage Systems FHWA* (1999) (GEC-4). Design and detail Class I ground anchor corrosion protection for permanent ground anchor systems in accordance with the requirements of GEC-4 and PTI (2014). Specify Class II corrosion protection for temporary ground anchors. In this context the term "temporary" is for systems will be in place 36 months or less.

### 16.10.5 Anchor Load Testing

All production ground anchors shall be proof tested, except for anchors that are subject to performance tests. A minimum of 5 percent of the total number of wall anchors shall be performance tested. Ground anchor testing and the resulting test data shall be witnessed and recorded by the Engineer.

Specify the sequence and manner of ground anchor stressing to prevent local overstress of the wale, sheet pile, and/or their connection device. Anchors shall be stressed in a uniform manner to prevent overstress.

### 16.10.6 Ground Anchor Proof Testing Schedule

Include in the Contract Documents the selection, frequency, requirements, proof test schedule and load test acceptance criteria given in AASHTO LRFD Bridge Design Specifications. Be aware that AASHTO Bridge Construction Specifications 6.5.5 use unfactored design load (DL) and safety factor as compared to AASHTO LRFD Design. The following table is presented for LRFD Factored Design Load (FDL):

**Table 16-11 Ground Anchor Proof Test Schedule**

Proof Test Schedule	
Applied Load (LRFD Design)	
AL	
0.20FDL	
0.40FDL	
0.60FDL	
0.80FDL	
1.00FDL	Hold test load 10 minutes minimum. See Note 1.
AL (optional)	
Lock-off load	
Lift-off test	

AL = Alignment Load      FDL = Factored Design Load

Note 1. Perform creep test measurements on the maximum load in the test. The load-hold period shall start as soon as the maximum test load is applied, and the ground anchor movement shall be measured and recorded at 1 min, 2, 3, 4, 5, 6, and 10 min. If the ground anchor movement between 1 min and 10 min exceeds 0.04 in., the maximum test load shall be held for an additional 50 min. If the load hold is extended, the ground anchor movement shall be recorded at 15 min, 20, 30, 45, and 60 min. If the creep test is extended, the creep movement between the 6- and 60-minute readings shall be less than 0.08 in for acceptance. A graph shall be constructed showing a plot of ground anchor movement versus load for each load increment in the proof test. Graph format shall be approved by the Engineer prior to use.

## 16.10.7 Ground Anchor Performance Testing Schedule

Include in the Contract Documents the selection, frequency, requirements, performance test schedule and load test acceptance criteria given in AASHTO LRFD Bridge Design Specifications. Be aware that 2017 AASHTO Bridge Construction Specifications 6.5.5. Use unfactored design load (DL) and safety factor as compared to AASHTO LRFD Design. The following table modifies FHWA GEC-4 Table 21 to LRFD form in terms of Factored Design Load (FDL):

Table 16-12 Ground Anchor Performance Test Schedule

Performance Test Schedule			
Applied Load (LRFD Design)	Total movement at load cycle maximum $\delta_{Ti}$	Residual movement at AL after cycle maximum $\delta_{Ri}$	Elastic movement at load cycle maximum $\delta_{Ei}$
AL 0.20FDL	$\delta_{T1}$		$\delta_{T1} - \delta_{R1} = \delta_{E1}$
AL 0.20FDL 0.40FDL	$\delta_{T2}$	$\delta_{R1}$	$\delta_{T2} - \delta_{R2} = \delta_{E2}$
AL 0.20FDL 0.40FDL 0.60FDL	$\delta_{T3}$	$\delta_{R2}$	$\delta_{T3} - \delta_{R3} = \delta_{E3}$
AL		$\delta_{R3}$	

0.20FDL			
0.40FDL			
0.60FDL			
0.80FDL	$\delta_{T4}$		$\delta_{T4} - \delta_{R4} = \delta_{E4}$
AL		$\delta_{R4}$	
0.20FDL			
0.40FDL			
0.60FDL			
0.80FDL			
1.00FDL	$\delta_{T5}$ (test load time zero reading for creep test) (see Note 1 for additional interval measurements)		$\delta_{T5} - \delta_{R5} = \delta_{E5}$
AL		$\delta_{R5}$	
0.00DL (unload)			

AL=Alignment Load FDL=Factored Design Load  $\delta_i$ =total movement at a load other than maximum for cycle, i=number identifying a specific load cycle.

Note 1. Perform creep test measurements on the maximum load in the test as described in Table 16-11 above.

### 16.10.8 Deadmen or Anchor Blocks

Design deadmen or anchor blocks using passive earth pressure resistance and active earth pressure loads in accordance with the AASHTO LRFD Bridge Design Specifications, *Foundations and Earth Structures*, NAVFAC DM7.02 (U.S. Navy, 1986), the *USS Sheet Piling Design Manual* (United States Steel, 1984), and the requirements of the *ODOT GDM*. The deadmen location

shall have sufficient embedment within the passive earth pressure zone, beyond the wall active earth pressure zone, as described in Section 4, Figures 20 and 21 in *NAVFAC DM7.02* (U.S. Navy, 1986). Figures 20 and 21 have been reproduced as [Figure 16-11](#) and [Figure 16-12](#), respectively.

Figure 16-10 Effect of Anchor Block Location, Active/Passive Earth Pressure and Tie-Rod Resistance

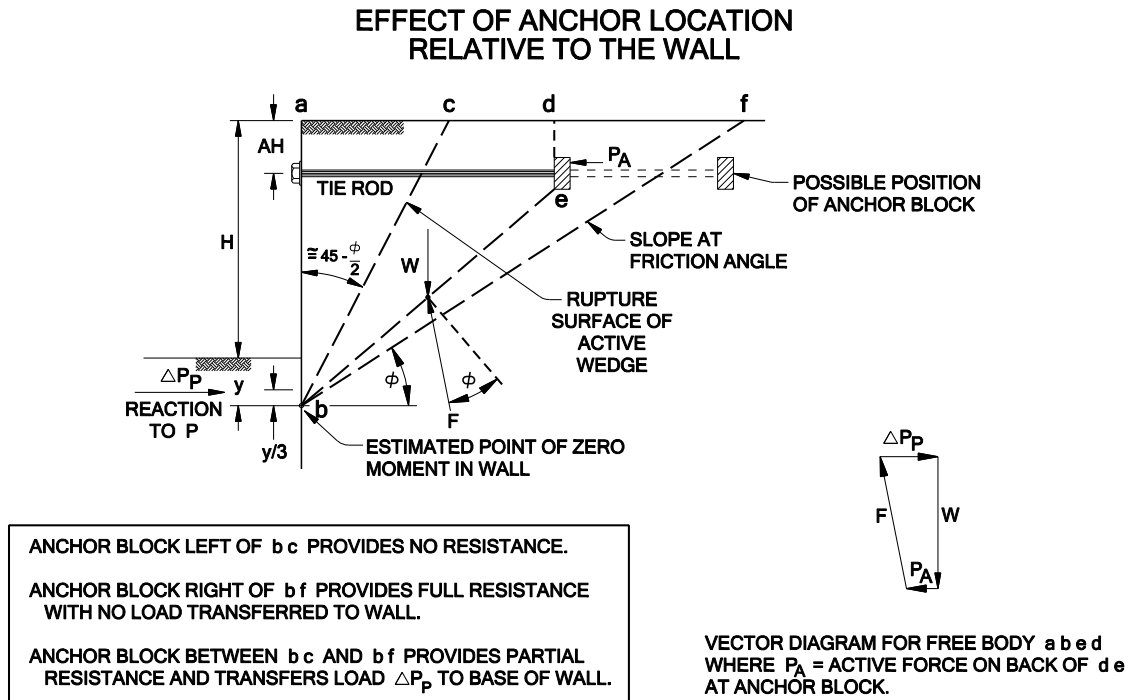

### CONTINUOUS ANCHOR WALL LOCATED BETWEEN RUPTURE SURFACE AND SLOPE AT FRICTION ANGLE

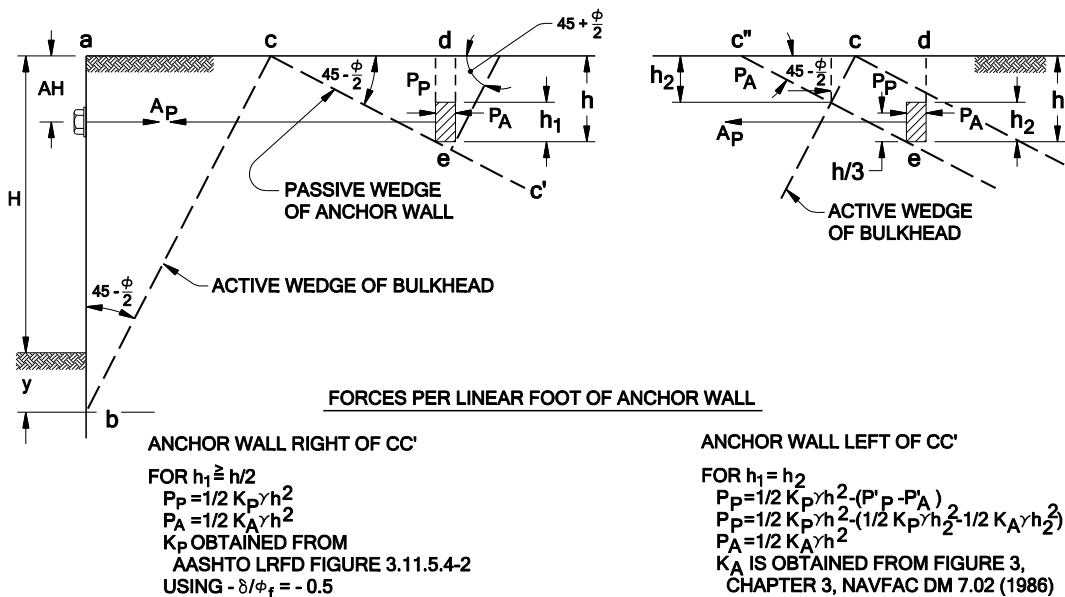
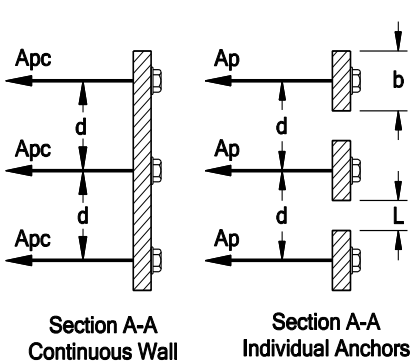

Figure 16-11 Effect of Anchor Block Spacing on Tie-Rod Resistance, Continuous and Individual Anchor Blocks

EFFECT OF DEPTH AND SPACING OF ANCHOR BLOCKS



ANCHORAGE RESISTANCE FOR  $h_1 \geq \frac{h}{2}$

1. CONTINUOUS WALL:  
 ULTIMATE  $A_{pc}/d = P_p - P_a$  WHERE  $A_{pc}/d$  IS ANCHOR RESISTANCE AND  $P_p, P_a$  TAKEN PER LINEAL FOOT OF WALL.
2. INDIVIDUAL ANCHORS:  
 IF  $d > b + h$ , ULTIMATE  $A_p = b(P_p - P_a) + 2P_0 \tan \phi$ , WHERE  $P_0 =$  RESULTANT FORCE OF SOIL AT REST ON VERTICAL AREA  $cde$  OR  $c'de$ .  
 IF  $d = h + b$ ,  $A_p/d$  IS 70% OF  $A_{pc}/d$  FOR CONTINUOUS WALL.  
 L FOR THIS CONDITION IS  $L'$  AND  $L' = h$ .  
 IF  $d < h + b$ ,  $A_p/d + A_{pc}/d = A_{pc}/d - \frac{L'}{L} (0.3 A_{pc}/d)$ ,  $L' = h$ .

ANCHOR RESISTANCE FOR  $h_1 < \frac{h}{2}$

ULTIMATE  $A_p/d$  OR  $A_{pc}/d$  EQUALS BEARING CAPACITY OF STRIP FOOTING OF WIDTH  $h_1$  AND SURCHARGE LOAD  $\gamma(h - \frac{h_1}{2})$ , SEE FIGURE 1, CHAPTER 4, NAVFAC DM 7.02 (1986)  
 USE FRICTION ANGLE  $\phi'$ : WHERE  $\tan \phi' = 0.6 \tan \phi$ .

GENERAL REQUIREMENTS:

1. ALLOWABLE VALUE OF  $A_p$  AND  $A_{pc} =$  ULTIMATE VALUE /2, FACTOR OF SAFETY OF 2 AGAINST FAILURE.
2. VALUES OF  $K_A$  AND  $K_p$  ARE FOR COHESIONLESS MATERIALS. IF BACKFILL HAS BOTH  $\phi$  AND  $c$  STRENGTHS, COMPUTE ACTIVE AND PASSIVE FORCES ACCORDING TO FIGURES 7 AND 9, Chapter 3, NAVFAC DM7.02 (1986). FINE GRAINED SOILS OF MEDIUM TO HIGH PLASTICITY SHOULD NOT BE USED AT THE ANCHORAGE.
3. SOILS WITHIN PASSIVE WEDGE OF ANCHORAGE SHALL BE COMPACTED TO AT LEAST 100 PERCENT OF RELATIVE MAXIMUM DENSITY PER AASHTO T99.
4. TIE ROD IS DESIGNED FOR ALLOWABLE  $A_p$  OF  $A_{pc}$ . TIE ROD CONNECTIONS TO WALL AND ANCHORAGE ARE DESIGNED FOR 1.2 (ALLOWABLE  $A_p$  OF  $A_{pc}$ ).
5. TIE ROD CONNECTION TO ANCHORAGE IS MADE AT THE LOCATION OF THE RESULTANT EARTH PRESSURES ACTING ON THE VERTICAL FACE OF THE ANCHORAGE.



## 16.10.9 Tie-Rods

Tie-rods shall be designed in accordance with the *AASHTO LRFD Bridge Design Specifications, Foundations and Earth Structures*, NAVFAC DM7.02 (U.S. Navy, 1986), the *USS Sheet Piling Design Manual* (United States Steel, 1984), and the requirements of the *ODOT GDM*.

Anchored sheet pile wall failures have occurred in the tie-rod as a result of damage from excessive differential settlement along the tie-rod, especially at the connection to the wall face. The tie-rod shall be isolated from the adverse effects of excessive settlement of the wall and/or backfill, including excessive bending, shear or tension in the tie-rod. Perform ground improvement to reduce post-construction foundation settlement to reduce settlement magnitudes if isolation of the tie-rod is not feasible.

Specify the sequence of tie-rod stressing to prevent local overstress of the wale, sheet pile, and/or their connection device. Corrosion protection of the tie-rod, wale and their connection device is necessary to assure adequate long-term wall performance.

## 16.11 Soil Nail Walls

### 16.11.1 General Considerations

Soil nail walls consist of passive reinforcement of the ground behind an excavation face by drilling and installing closely spaced rows of grouted steel bars (i.e., soil nails). The soil nails are subsequently covered with a reinforced-shotcrete layer (temporary facing) used to stabilize the exposed excavation face, support the subdrainage system (i.e., composite strip drain, collector and drainage pipes), and distribute the soil nail bearing plate load over a larger area. A permanent facing layer, meeting both structural and aesthetic requirements, is constructed directly on the temporary facing.

The principal components of a typical soil nail wall system are presented in Figure 3.1 of *Geotechnical Engineering Circular No. 7 - Soil Nail Walls* (FHWA, 2015). Soil nail walls are typically used to stabilize excavations where top-down construction, without the effects of drilling or pile installation (impact hammer or vibratory methods), is a significant advantage compared to other retaining wall systems.

Conventional soil nail wall systems are best suited for sites with dense to very dense, granular soil with some apparent cohesion (sands and gravels), stiff to hard, fine-grained soil (silts and clays) of relatively low plasticity ( $PI < 15$ ), or weak, weathered massive rock with no adversely-oriented planes of weakness. Soil nail wall construction requires that open excavations stand unsupported long enough to allow soil nail drilling and grouting, subdrainage installation, reinforcement, and temporary shotcrete placement.

Design of soil nail wall systems requires a detailed geotechnical investigation to explore, sample, characterize and test soil and rock conditions within and around the soil nail reinforced zone behind each wall. The geotechnical investigation shall determine the depth, limits and failure surface

geometry of any existing or potential shear failure surface, slope failure, or landslide within or near the soil nail reinforced zone.

Geotechnical investigation requirements are outlined in [Chapter 4](#). At a minimum, the geotechnical information required for soil nail design includes SPT N-values (depth intervals of 5ft, or less), soil profile, groundwater levels, unit weight, natural water content, Atterberg limit, soil electrochemical properties (e.g., pH, resistivity, organic content, chloride and sulfate concentrations), sieve analysis, shear strength, consolidation parameters, foreslope and backslope inclinations, and groundwater levels. Additionally, shallow test pit(s) should be advanced along the line of the wall face to evaluate excavation stability and stand-up time for temporary excavations required for soil nail wall construction. The test pits shall remain open for at least 24 hours and shall be monitored for sloughing, caving, and groundwater seepage. The depth of the test pits shall be at least twice the anticipated vertical nail spacing with a trench bottom length of at least 1.5 times the trench excavation depth.

### **16.11.2 Wall Footprint and Soil Nail Easement**

The soil nail design length, spacing and inclination shall be based on site-specific soil and rock conditions in the soil nail reinforced zone, geometric constraints, and stability requirements. Soil nails shall be at least 12-ft in length, or 60 percent of the wall height, whichever is greater. Uniform soil nail lengths are typically used when back wall deformations are not a concern for the project, such as when soil nails are supported in competent ground and/or structures are not present within the zone of influence behind the wall. Wall deformations can be effectively controlled by using longer soil nails in the upper portions of the wall. Preliminary soil nail design typically assumes a minimum soil nail length of 70 percent of the wall height, which is frequently increased due to factors such as wall heights greater than 33 ft., large surcharge loads, overall (global) stability, seismic loads, and/or strict wall deformation requirements.

The horizontal and vertical spacing of soil nails are typically the same: between 4 and 6½ft for conventional drilled soil nail wall systems. The maximum soil nail spacing meeting design requirements shall be used to improve wall constructability. Soil nails may be arranged in a square, row-and-column pattern or an offset, diamond-pattern. Horizontal nail rows are preferred, but sloping rows may be used to optimize the nail pattern. Soil nail rows should be linear to the greatest extent possible—so each individual nail location elevation can be easily interpolated from a reference nail(s). Nails along the top row shall have at least 1 foot of soil cover over the nail drill hole during installation. Soil nails are installed at angles of 10–30 degrees below the horizontal. To prevent voids in the grout, soil nails shall not be installed at inclination less than 10 degrees. Steeper anchor inclinations may be required to avoid underground utilities, adjacent foundations, right-of-way restraints, or unsuitable soil or rock layers.

The soil nail wall face batter typically varies between 0 and 10 degrees.

### 16.11.3 Design Requirements

1. Design soil nail walls using LRFD principles and methodology in *Geotechnical Engineering Circular No. 7 – Soil Nail Walls* (FHWA, 2015). AASHTO LRFD Bridge Design Specifications 9<sup>th</sup> edition (2020) provides LRFD design based on the FHWA, 2015 manual.
2. The external, internal, and facing connection failure modes as well as wall static and seismic wall deformation shall be analyzed for soil nail walls using the methodologies and procedures presented in Sections 5.1 through 5.9 of *Geotechnical Engineering Circular No. 7 – Soil Nail Walls* (FHWA, 2015).
3. The soil nail wall system must be safe against all potential failure modes. Typical external, internal and facing failure modes presented in Figure 5.8 (FHWA, 2015) have been reproduced as Figure 16-12).
4. There is no standard laboratory strength testing procedure to accurately measure the bond strength of a grouted soil nail. Bond strength values are typically estimated using the values presented in Tables 4.4a, 4.4b, and 4.5 in *Geotechnical Engineering Circular No. 7 – Soil Nail Walls* (FHWA, 2015). Given the uncertainties in accurately estimating soil nail bond strength, it is recommended that pre-production soil nail tests (verification tests) be required to verify the bond strengths and included in the construction specifications.
5. Highway Retaining Wall permanent soil nail walls are designed to have a minimum Design Life of 75 years. Bridge Retaining Wall permanent soil nail walls shall be designed to have a minimum design life consistent with the bridge, but not less than 75 years.
6. Design soil nail walls for seismic design forces in accordance with AASHTO LRFD, *Geotechnical Engineering Circular No. 7 – Soil Nail Walls* (FHWA, 2015), Section 16.3.13, and the following recommendations:
  - Soil nail wall analyses (Extreme I limit state loads) shall confirm the wall can resist forces due to static and seismic earth pressures (including water head load if applicable) and inertial forces of the wall without structural failure or excessive sliding, movement, or rotation of the soil nail wall.
  - Stability analyses of soil nail walls shall be designed using the most current versions of Gold Nail (version 3.11), the Caltrans SnailzWin 3.10 (version 6.01) or Snail programs.
  - External and compound stability analyses of soil nail walls shall be performed using a state-of-the-practice slope stability computer program, such as the most current versions of Slope/W<sup>®</sup> (Geo-Slope International), and ReSSA<sup>®</sup> (ADAMA Engineering, Inc.) as described in Section 16.3.13 and AASHTO LRFD.
  - The design horizontal acceleration coefficient ( $k_h$ ) of soil nail walls shall be in accordance with AASHTO Article 11.6.5.
7. The soil nail wall system must be safe against any potential temporary critical wall stability condition that may exist during construction. For example, the soil nail wall must be safe against all modes of failure from temporary, unreinforced, near-vertical excavations required to install additional nailed lifts.

Figure 16-12 Soil Nail Walls: External, Internal, Global, and Facing Failure Mode

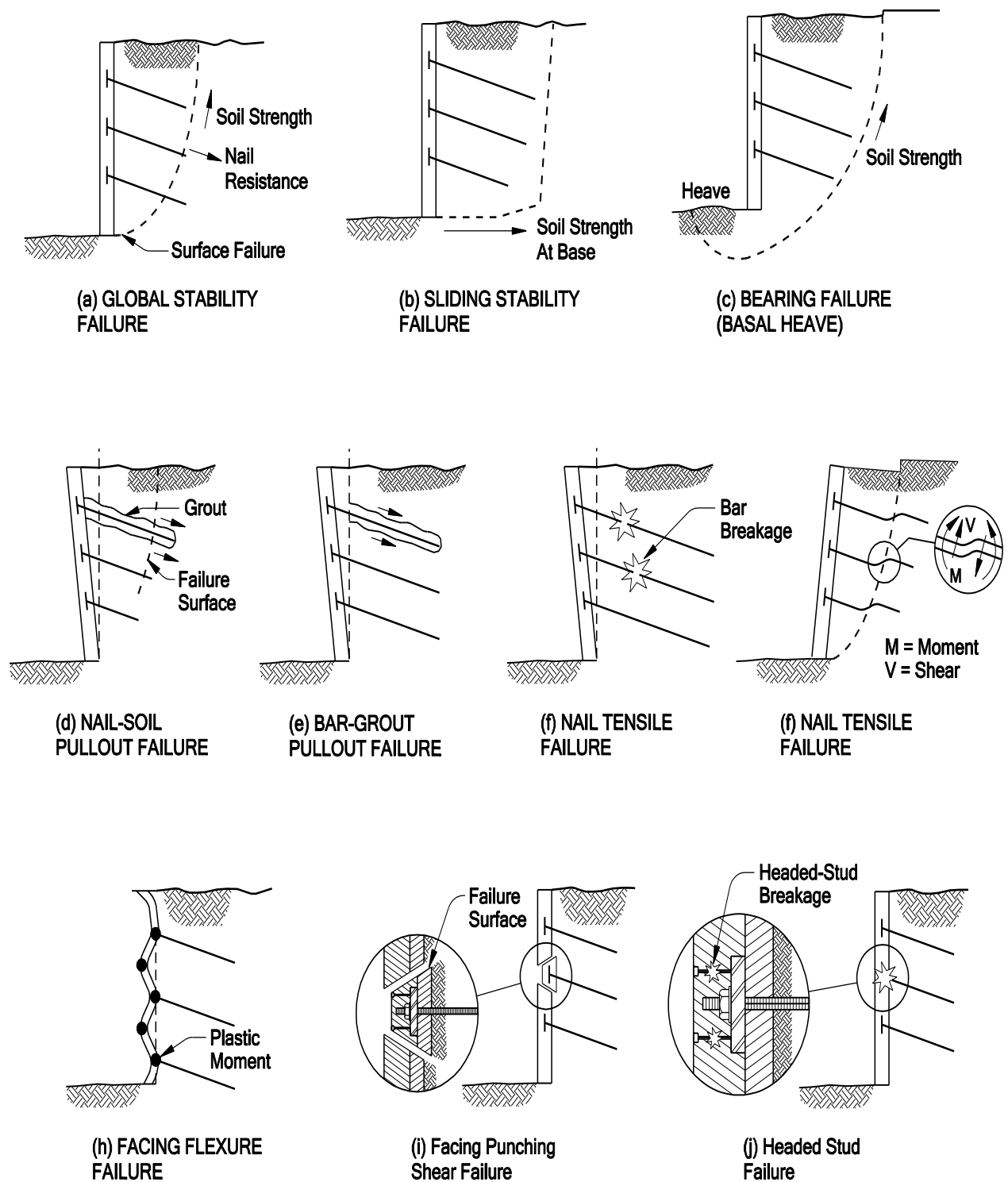

## 16.11.4 Facing

A permanent wall facing is required for all permanent soil nail walls. In addition to meeting aesthetic requirements and providing adequate corrosion protection to the steel soil nail, design facing for all facing connection failure modes, including but not limited to those indicated in [Figure 16-12](#).

The soil nail wall face batter typically varies between 0 and 10 degrees.

## 16.11.5 Corrosion Protection

Corrosion protection is required for all soil nail wall systems. Protection of the metallic components of the soil nail wall against corrosion after construction is necessary to assure adequate long-term wall durability. ODOT requires double corrosion protection for all permanent soil nails (Class A and Class B or Class A and Class C) and either Class B or Class C protection for temporary soil nails. *Geotechnical Engineering Circular No. 7 – Soil Nail Walls* (FHWA, 2015) details corrosion protection levels for soil nails as shown in Table 16-13:

Table 16-13 Corrosion Protection Levels in Soil Nails

Class Protection	Protection Methods Used (Note 1)	Conditions/Remarks
A	Encapsulation	<ul style="list-style-type: none"> <li>Aggressive soil, or unknown corrosion potential</li> <li>Non-aggressive soil conditions with low risk tolerance</li> <li>This is the highest level used in practice; however, in extreme situations, encapsulation can be combined with epoxy coating or galvanization</li> </ul>
B	Epoxy Coating or Galvanization	<ul style="list-style-type: none"> <li>Non-aggressive soil conditions with intermediate or high risk tolerance</li> </ul>
C	Bare Steel Tendon (Sacrificial Steel)	<ul style="list-style-type: none"> <li>Non-aggressive soil conditions with high risk tolerance</li> </ul>

Note 1. All soil nail bars are assumed to be grouted and include the grout protection in each class protection level listed herein.

## 16.11.6 Load Testing

Soil nails are field tested to verify nail design loads can be supported without excessive movement and with an adequate margin of safety. Perform both verification and proof testing of designated test nails. Creep tests are performed as part of proof tests and verification tests.

Perform preproduction verification tests on sacrificial test nails at locations shown on the plans and/or described in the Special Provisions. Preproduction verification testing shall be performed prior to installation of production soil nails to verify the Contractor's installation methods, proposed drill hole diameter and pullout resistance. Perform a minimum of two verification tests in each principal soil or rock unit providing soil nail support and for each different drilling/grouting method proposed to be used, at each wall location. Verification test soil nails will be sacrificial and not incorporated as production nails.

Verification test nails shall have both bonded and unbonded lengths. Prior to testing only the bonded length of the test nail shall be grouted. The unbonded length of the test soil nail shall be at least 3.0 ft. The bonded length of the test nail shall be determined based on the production nail bar grade and size such that the bar structural load capacity is not exceeded during testing and shall not be less than 10 feet. Verification test nails shall be incrementally loaded to the Verification Test Load (VTL). The VTL is an "ultimate" load, not a "design" load. The loading schedule in Section 16.11.7 is reproduced from Table 9.1 (FHWA 2015). Do not apply loads greater than 80 percent of the minimum guaranteed ultimate tensile strength of the tendon for Grade 150 bars, or 90 percent of the yield strength of the tendon for Grade 60 or 75 bars.

Soil nail capacity is sensitive to the Contractor's drilling, installation, and grouting methods and changes in soil and rock support conditions. Therefore, additional soil nail verification testing is required at any time the Contractor changes construction equipment or methods, or if there is a change in soil or rock support conditions.

## 16.11.7 Soil Nail Verification Test Schedule

Perform verification tests on soil nails at locations selected by the Engineer. Verification tests on soil nails shall be installed using the same equipment, methods, nail inclinations, nail lengths, and hole diameters as the production nails. Required soil nail test data shall be recorded by the Engineer - including the bonded and unbonded lengths for each tested soil nail.

The following schedule shall be used for verification tests:

**Table 16-14 Soil Nail Verification Tests**

Test Load	Hold Time (minutes) (Note 2)
AL (Note 1)	1.
0.13 VTL	10(recorded at 1, 2, 4, 5, 10).
0.25 VTL	10(recorded at 1, 2, 4, 5, 10).

0.38 VTL	10(recorded at 1, 2, 4, 5, 10).
0.50 VTL	10(recorded at 1, 2, 4, 5, 10).
0.63 VTL	10(recorded at 1, 2, 4, 5, 10).
<b>0.75 VTL (Creep Test)</b>	<b>60(recorded at 1, 2, 4, 5, 6, 10, 20, 30, 50, 60).</b>
0.88 VTL	10
1.00 VTL	10
AL	1 (Note 3).

**Notes:**

1. AL = alignment load, which is commonly less than or equal to 0.025 VTL.
2. Soil movement must be measured after each load increment has been achieved and at each time step.
3. Permanent soil nail movement must also be recorded.

**Test acceptance criteria require that:**

- Pullout does not occur at loads less than 1.00 VTL.
- The total movement ( $\Delta_{VTL}$ ) measured at VTL must exceed 80 percent of the theoretical elastic elongation of the unbonded length ( $L_{UB}$ ), as defined below.
- The creep movement does not exceed the criteria:
  - The creep movement between the 1- and 10-minute readings at 0.75 VTL is less than 0.04 in.
  - The creep movement between the 6- and 60-minute readings at 0.75 VTL is less than 0.08 in.

The creep rate is linear or decreasing throughout the creep test load-hold period.

**Equation 16-1 Theoretical elastic elongation of the unbonded length in verification tests**

$$\Delta_{VTL} > 0.8 \frac{VTL L_{UB}}{E A_t}$$

Where:

E = Young's modulus of steel (29,000 ksi)

This last item ensures that load transfer from the soil nail to the soil occurs only in the bonded length and not in the unbonded length

## 16.11.8 Soil Nail Proof Test Schedule

Perform proof tests on production soil nails at locations selected by the Engineer. Successful proof testing shall be demonstrated on at least 5 percent of production soil nails in each nail row

or a minimum of one per row. Required soil nail test data shall be recorded by the Engineer - including the bonded and unbonded lengths for each tested soil nail.

Production proof test nails shall have both bonded and temporary unbonded lengths. Prior to testing, only the bonded length of the test nail shall be grouted. The temporary unbonded length of the test nail during proof testing shall be at least 3 ft. The bonded length of the test nail during proof testing shall be at least 10 ft., except production proof test nails shorter than 12 ft may be constructed with less than the minimum 10 ft bond length. Fully grouted nails must not be proof tested.

Proof tests shall be performed by incrementally loading the proof test nail to a maximum test load. Similar to the verification test, the bonded length of test soil nails during proof tests must be selected such that a bond limit is achieved before overstressing the bar. Proof tests are conducted according to the loading schedule of Table 16-15. Each load increment is held for at least 10 minutes.

The following shall be used for proof tests:

**Table 16-15 Soil Nail Proof Test Schedule**

Test Load	Hold Time (minutes) (Note 3)
AL	1.
0.17 PTL	Until Movement Stabilizes (Note 4)
0.33 PTL	5 Min.Until Movement Stabilizes
0.50 PTL	5 Min.Until Movement Stabilizes
0.67 PTL	5 Min.Until Movement Stabilizes
0.83 PTL	5 Min.Until Movement Stabilizes
1.0 PTL (Creep Test) (Note 2)	10 recorded at 1, 2, 4, 6, and 10.
AL	1

**Notes:**

1. AL = alignment load, which should be  $AL \leq 0.025$  PTL. PTL is the Proof Test Load (maximum test load)
2. If the nail movement measured between 1 and 10 minutes exceeds 0.04 in., PTL must be maintained for 50 additional minutes and movements must be recorded at 20, 30, 50, and 60 minutes. The permanent soil movement must also be recorded.
3. Times are measured after the target load has been achieved in each increment.
4. If the soils reinforced with nails are relatively susceptible to deformation of creep, it is recommended to hold each load increment for 10 minutes and to record the soil nail movement at 1, 2, 5, and 10 minutes.

A proof tested nail is acceptable if the following criteria are met:

- No pullout occurs at loads less than 1.0 PTL.



- The total soil nail movement ( $\Delta_{PTL}$ ) measured at PTL is greater than 80 percent of the theoretical elastic elongation of the unbonded length ( $L_{UB}$ ), as defined below.
- The creep movement does not exceed the criteria:
  - The creep movement is less than 0.04 in. between the 1- and 10-minute readings.
  - If this movement is exceeded, PTL must be maintained for an additional 50 minutes with readings recorded at 20, 30, 50, and 60 minutes.
  - If the creep test is extended, the creep movement between the 6- and 60-minute readings is less than 0.08 in.

**Equation 16-2 Theoretical elastic elongation of the unbonded length in proof tests.**

$$\Delta_{PTL} > 0.8 \frac{PTL L_{UB}}{E A_t}$$

## 16.12 Tangent/Secant Pile Walls

Tangent/secant pile walls shall be designed as non-gravity (cantilever) or anchored retaining walls in accordance with ODOT [Section 16.8](#), except as noted in this section. Selection, design, and construction criteria for tangent/secant pile walls are provided in *Geotechnical Engineering Circular No. 2 - Earth Retaining Systems*, FHWA (1997).

Tangent/secant pile walls consist of rows of cast-in-place, reinforced concrete drilled shafts (typically 24- to 48-in. diameter) that are tangentially touching (tangent piles) or overlapping (secant piles) to create a continuous retaining wall. Greater wall heights can be achieved using ground anchors (tiebacks). Tangent/secant pile walls are typically used in permanent excavation applications. Tangent/secant pile wall construction is a relatively noise-free and vibration-free alternative to sheet pile and soldier pile wall installations.

Tangent/secant pile walls with ground anchors are very stiff wall systems that can reduce ground movements to a strict tolerance. Anchored walls have been successfully used for underpinning building foundations and other settlement-sensitive structures near excavations. Tangent/secant pile walls also create an effective groundwater seepage barrier and have cofferdam applications. Walls shall either be designed to drain the retained earth or be designed for hydrostatic pressures in accordance with AASHTO Articles 3.11.3 and 11.6.6 of the *AASHTO LRFD Bridge Design Specifications*.

## 16.13 Slurry/Diaphragm Walls

Slurry/diaphragm walls shall be designed as non-gravity (cantilever) or anchored retaining walls as indicated in [Section 16.9](#), except as noted in this section. Selection, design, and construction criteria for slurry/diaphragm walls are provided in *Geotechnical Engineering Circular No. 2 - Earth Retaining Systems*, FHWA (1997).

Slurry/diaphragm walls are typically used for permanent applications and consist of cast-in-place, reinforced concrete panels constructed in a trench-using mineral or polymer slurry to maintain trench stability. The walls are well suited for sites where flexible sheet pile walls would have potential installation problems due to high penetration resistance in very dense and/or coarse soils (gravel, cobbles, or boulders). Slurry/diaphragm walls have a very high section modulus and are well suited for applications with strict wall movement criteria. The walls also provide a highly effective seepage barrier that allows for rapid excavation dewatering and long-term, watertight construction. Other advantages include relatively high vertical and lateral load capacities and minimal construction vibration effects. New trench cutting equipment has headroom requirements of less than 20 ft.

Slurry/diaphragm walls should include a properly designed subdrainage system or be designed as a watertight structure with hydrostatic pressures (AASHTO Articles 3.11.3 and 11.6.6 of the *AASHTO LRFD Bridge Design Specifications*). Since slurry/diaphragm walls can have a very high section modulus, consider wall movement magnitudes to reach active earth pressures conditions (Table C3.11.1-1 in AASHTO Article 3.11.1). Design for at-rest earth pressures (AASHTO Article 3.11.5.2) if wall movement is restrained.

## 16.14 References

- Adams, M. and J. Nicks. 2018. Reinforced Soil Abutments and Integrated Bridge Systems, FHWA-HRT-17-080. Federal Highway Administration, Washington D.C.
- Adams, M., J. Nicks, T. Stabile, W. Schlatter, and J. Hartmann. 2012. Geosynthetic Reinforced Soil Integrated Bridge System Interim Implementation Guide, FHWA-HRT-11-026. Federal Highway Administration, Washington D.C.
- Adams, M., J. Nicks, T. Stabile, J. Wu, W. Schlatter, and J. Hartmann. 2011. Geosynthetic Reinforced Soil Integrated Bridge System, Synthesis Report, FHWA-HRT-11-027. Federal Highway Administration, Washington D.C.
- American Association of State Highway and Transportation Officials. 2002. Standard Specifications for Highway Bridges, 17th Edition. American Association of Highway and Transportation Officials, Washington D.C.
- American Association of State Highway and Transportation Officials. 2009. AASHTO Guide Specifications for LRFD Seismic Bridge Design. 2nd Edition. American Association of State Highway and Transportation Officials, Washington D.C.
- American Association of State Highway and Transportation Officials. 2020. AASHTO LRFD Bridge Design Specifications, 9th Edition. American Association of State Highway and Transportation Officials, Washington D.C.
- American Association of State Highway and Transportation Officials. 2021. Standard Specification for Geosynthetic Specification for Highway Applications, M288-21. American Association of State Highway and Transportation Officials, Washington D.C.
- Anderson, D. G. 2008. Seismic Analysis and Design of Retaining Walls, Slopes and Embankments, and Buried Structures, NCHRP Report 611. National Cooperative Highway Research Program, Transportation Research Board, National Research Council, Washington, D.C.

- Berg, R. R., N. C. Samtani, and B. R. Christopher. 2009. Design of Mechanically Stabilized Earth Walls and Reinforced Slopes, Geotechnical Engineering Circular No. 011, Vol. I, FHWA-NHI-10-024, & Vol. II, FHWA-NHI-10-025. Federal Highway Administration, Washington D.C.
- Bligh, R. P., J. L. Briaud, A. Abu-Odeh, D. O. Saez, L. S. Maddah, and K. M. Kim. 2022. Design Guidelines for Test Level 3 through Test Level 5 Roadside Barrier Systems Placed on Mechanically Stabilized Earth Retaining Walls, NCHRP Web Only Document 326. Transportation Research Board, National Research Council, National Academies, Washington D.C.
- Bowles, J. E. 1988. Foundation Analysis and Design. McGraw-Hill, New York, N.Y.
- Brown, D. A., S. Dapp, W. R. Thompson, and C. A. Lazarte. 2007. Design and Construction of Continuous Flight Auger (CFA) Piles, Geotechnical Engineering Circular No. 8, FHWA-HIF-07-039. United States. Federal Highway Administration, Office of Technology Applications, Washington D.C.
- California Department of Transportation. 2004. Bridge Design Specifications. CALTRANS, Sacramento, CA.
- Carter, L., and M. Bernardi. 2014. "NCMA's Design Manual for Segmental Retaining Walls." Geosynthetics.
- Cedergren, H. R. 1997. Seepage, Drainage, and Flow Nets, Vol. 16. Wiley, New York, N.Y.
- Clough, G. W. and J. M. Duncan. 1991. "Earth pressures." In Foundation Engineering Handbook, 223-235. Springer.
- Das, B. M. 1990. Principles of Geotechnical Engineering. Kent Publishing Company, Boston, M.A.
- LPILE. Ensoft, Inc.
- Slope/W, Geo-Slope International.
- Holtz, R. D., B. R. Christopher, and R. R. Berg. 2008. Geosynthetic Design and Construction Guidelines, FHWA-NHI-07-092. US Department of Transportation, Federal Highway Administration, Washington D.C.
- Kavazanjian Jr, E., N. Matasovic, T. Hadj-Hamou, and P. J. Sabatini. 1997. Design Guidance: Geotechnical Earthquake Engineering for Highways. Federal Highway Administration, Washington D.C.
- Kramer, S. L. 1996. Geotechnical Earthquake Engineering. Pearson Education India.
- Lambe, T. W. and R. V. Whitman. 1969. Soil Mechanics. Wiley, New York, N.Y.
- Lazarte, C. A., H. Robinson, J. E. Gomez, A. Baxter, A. Cadden, and R. R. Berg. 2015. Soil Nail Walls, Geotechnical Engineering Circular No. 7, FHWA-NHI-14-007. United States. Federal Highway Administration, Office of Technology Applications, Washington D.C.
- RESSA+. ADAMA Engineering, Inc., Clackamas, Oregon.
- MSE+. ADAMA Engineering, Inc., Clackamas, OR.
- Oregon Department of Transportation. 2012. Highway Design Manual. ODOT, Salem, OR.
- Oregon Department of Transportation. 2014. Hydraulic Design Manual. ODOT, Salem, OR.
- Oregon Department of Transportation. 2022. Bridge Design Manual. ODOT, Salem, OR.

- Peck, R. B. and G. Mesri. 1987. "Discussion of "Compaction-Induced Earth Pressures under Ko-Conditions" by J. M. Duncan and R. B. Seed (January, 1986, Vol. 112, No. 1)." *Journal of Geotechnical Engineering* 113 (11): 1406-1408.
- Post Tensioning Institute. 2014. Recommendations for Prestressed Rock and Soil Anchors. PTIDC-35. Post-Tensioning Institute, Farmington Hills, MI.
- Rixner, J. J., S. R. Kraemer, and A. D. Smith. 1986. Prefabricated Vertical Drains, Vol. I: Engineering Guidelines. Turner-Fairbank Highway Research Center, Federal Highway Administration, U.S. Department of Transportation, McLean, VA.
- Rogers, T. and B. Siel. February 2018. Oregon Department of Transportation Geo-Professional Program Review.
- Sabatini, P. J., R. C. Bachus, P. W. Mayne, J. A. Schneider, and T. E. Zettler. 2002. Evaluation of Soil and Rock Properties Technical Manual, Geotechnical Engineering Circular No. 5, FHWA-IF-02-034. US Department of Transportation, Federal Highway Administration, Washington D.C.
- Sabatini, P. J., D. G. Pass, and R. C. Bachus. 1999. Ground Anchors and Anchored Systems, Geotechnical Engineering Circular No. 4, FHWA-IF-99-015. US Department of Transportation, Federal Highway Administration, Washington D.C.
- Sabatini, P. J., T. Armour, P. Groneck, J. W. Keeley, and B. Tanyu. 2005. Micropile Design and Construction Reference Manual, FHWA-NHI-05-039. United States Department of Transportation. Federal Highway Administration, Washington D.C.
- Samtani, N. C. and E. A. Nowatzki. 2006. Soils and Foundations Reference Manual, Vol. I, FHWA-NHI-06-088 & Vol. II, FHWA-NHI-06-089. United States Department of Transportation, Federal Highway Administration, Washington D.C.
- Seed, R. B. 1983. Soil-Structure Interaction Effects of Compaction-Induced Stresses and Deflections (Finite Element Analysis). University of California, Berkeley, CA.
- Sowers, G. F. 1979. Introductory Soil Mechanics and Foundations: Geotechnical Engineering, 4th Edition. Macmillan, New York.
- Terzaghi, K. and R. B. Peck. 1967. Soil Mechanics in Engineering Practice. Wiley, New York N. Y.
- U.S. Army Corps of Engineers. 1986. Engineering and Design Seepage Analysis and Control for Dams. EM1110-2-1901. US Department of the Army, Washington D.C.
- US Army Corps of Engineers. 1989. Retaining and Flood Walls. EM1110-2-2502. US Army, Washington D.C.
- United States Federal Highway Administration: United States Steel Corporation. 1984. Steel Sheet Piling Design Manual. US Department of Transportation, Federal Highway Administration, Washington D.C.
- Washington Department of Transportation. 2010. Materials Manual, M46-01.05. WSDOT, Olympia, WA.
- Winterkorn, HF, and HY Fang. 1979. Foundation Engineering Handbook. Van Nostrand Reinhold, New York, N.Y.

# Appendix 16-A General Requirements for Proprietary Retaining Wall Systems

## 16-A.1 Overview

Proprietary retaining wall systems shall be designed and supported by the wall Manufacturer in accordance with the requirements of ODOT project plans, ODOT specifications, preapproved Manufacturer details, and this Manual (see [Section 16.2.1.2](#) for the definition of proprietary retaining wall system).

Proprietary retaining wall systems shall be preapproved by the Agency before being considered for use on Agency projects. Note that preapproval of a Manufacturer's retaining wall system does not imply preapproval of any other system from the Manufacturer. The Agency preapproves specific retaining wall systems and does not approve the Manufacturer.

Preapproval shall not be regarded as project specific design acceptance. The Manufacturer must also submit a project specific design according to Agency requirements. Submittal requirements for project specific designs are specified in the contract documents.

Submit proprietary retaining wall systems for preapproval according to [Appendix 16-B](#).

Preapproval will be based on an extensive technical audit by the Agency. This review examines system theory, Manufacturer design methods, details, materials, QA/QC plan, and construction methods. Constructability, Manufacturer support, and system performance on previous projects will also be considered.

The example calculations required in [Appendix 16-B](#) are intended to demonstrate that the proposed proprietary retaining wall system is capable of satisfying loading requirements for the proposed uses, and that the Manufacturer's design methods are in accordance with Agency requirements. The detail drawings required in [Appendix 16-D](#), are intended to demonstrate that manufacturer plans and details adequately address typical wall construction requirements.

Proprietary retaining wall systems are pre-approved by category. There are three retaining wall preapproval categories, corresponding to the three retaining wall definitions see [Section 16.2.1.1](#):

- Bridge retaining walls;
- Highway retaining walls; and
- Minor retaining walls

The Conditions of Preapproval and Preapproved Manufacturer Details for specific preapproved proprietary retaining wall systems may limit the use of preapproved proprietary retaining wall systems. See [Appendix 16-D](#) for specific Conditions of Preapproval and Preapproved Manufacturer Details for each preapproved proprietary retaining wall system.

## 16-A.2 Design and Construction Requirements:

Proprietary retaining wall systems shall meet the requirements of *AASHTO LRFD Bridge Design Specifications*, as modified by the *ODOT GDM*, and the *Oregon Standard Specifications for Construction*.

## 16-A.3 Responsibilities:

This section establishes responsibilities for both ODOT and the proprietary retaining wall system Manufacturer.

### 16-A.3.1 Agency Responsibilities:

#### 16-A.3.1.1 Agency Standards and Practices Responsibilities

- *ODOT Geotechnical Design Manual*.
- *Oregon Standard Specifications for Construction*.
- Preapproval of Proprietary Retaining Wall systems.

#### 16-A.3.1.2 Agency Design Responsibilities

- Select proprietary retaining wall systems that are appropriate for the project, and list them in the Project Special Provisions.
- Perform retaining wall overall (global) stability analysis (including preliminary compound stability analysis) and provide minimum requirements for overall and compound stability (i.e. minimum dimensions for overall and compound stability) in the Special Provisions. For MSE walls, provide the minimum soil reinforcement length from the Special Provisions.
- Perform preliminary external stability analysis (sliding, eccentricity, bearing), and provide minimum requirements for external stability (i.e., minimum dimensions for external stability) in the project plans and/or special provisions.
- Perform retaining wall settlement analysis for the Service Limit State and provide nominal and factored settlement limited bearing resistance and settlement estimates in the project plans and/or special provisions.
- Perform retaining wall bearing resistance analysis for the Strength and Extreme Event Limit States and provide nominal and factored bearing resistances in the project plans and/or special provisions.
- Perform retaining wall drainage analysis and provide drainage design in the project plans and/or special provisions.
- Perform liquefaction analysis and provide liquefaction mitigation design for the retaining wall in the project plans and/or special provisions when applicable.
- Provide scour prevention design in the project plans and/or specification when applicable.
- Provide geotechnical properties and design values needed by the Manufacturer for design of the proprietary retaining wall system from the Special Provisions.

- Provide minimum required embedment depths for the retaining wall in the project plans.
- Provide special notes in the project plans and/or special provisions as applicable.
- Provide geotechnical /foundation data sheet in project plans.
- Provide a Final Geotechnical Report for the retaining wall to the Project Manager for use by the Manufacturer of the proprietary retaining wall system.
- Select acceptable preapproved proprietary retaining wall systems and list them in the project special provisions as “Options” or “Alternates.”
- Provide a wall-loading diagram or loading table with sufficient detail for the Manufacturer of the proprietary retaining wall system to design the wall.
- Prepare control plans see [Section 16.2.8.1](#).
- Prepare Special Provisions.

### **16-A.3.1.3 Agency Construction Assistance Responsibilities**

Review Manufacturer working drawings and calculations for conformance with contract documents, Conditions of Preapproval in [Appendix 16-D](#), and preapproved Manufacturer details in Appendix 15-D and the **ODOT** GDM. Also verify that all previous design assumptions are still valid for the specific proprietary retaining wall system proposed by the contractor.

Construction consultation.

### **16-A.3.2 Proprietary Retaining Wall System Manufacturer Responsibilities:**

- Obtain preapproval for the proprietary retaining wall system from the ODOT Retaining Structures Program before bidding on projects.
- Submit annual system updates (optional) (see [Appendix 16-A.7](#)).
- Design the proprietary retaining wall system to satisfy internal stability, external stability (bearing, sliding, and overturning), and compound stability under all applicable limit states. The design shall be in accordance with the project plans and specifications, the *ODOT GDM*, the Conditions of Preapproval for the specific proprietary retaining wall system in [Appendix 16-D](#), and the preapproved Manufacturer details in Appendix 15-D.
- Submit stamped working drawings and stamped calculations, according to the contract documents, for Agency review.
- Provide proprietary product (materials).
- Provide technical assistance in accordance with the contract documents.
- Satisfy all other applicable Agency requirements.

## 16-A.4 Preapproval Process and Submittal Requirements for Proprietary Retaining Wall Systems

The conditions of Preapproval for each preapproved proprietary retaining wall system are included in Appendix 15-D. Conditions of Preapproval are developed during the detailed technical audit of proprietary retaining wall systems.

### 16-A.5 Responsibility for Preapproval;

Preapproval of proprietary retaining wall systems is the responsibility of the ODOT Retaining Structures Program in special cases proprietary retaining wall systems may also be preapproved on a project specific basis by the local Region Tech Center. All project specific preapprovals of proprietary retaining wall systems shall be in accordance with the *ODOT GDM* and must be reported to the ODOT Retaining Structures Program.

### 16-A.6 Conditions of Preapproval for Specific Proprietary Retaining Wall Systems

The Conditions of Preapproval include, but are not limited to:

- Preapproved Manufacture detail drawings shown in Appendix 15-D;
  - See the Conditions of Preapproval for Agency comments and requirements regarding the proprietary retaining wall systems;
  - Details not shown on the preapproved Manufacturer detail drawings are not considered preapproved;
- General comments about the system;
- Categories preapproved (Bridge, Highway, Minor);
- Preapproval effective date;
- Preapproval maximum wall height; and
- Specific requirements intended to point out and correct Manufacturer practices that do not meet ODOT requirements. The ODOT EOR for the retaining wall system, and Agency personnel performing construction inspection and other Agency QA/QC functions shall consider the Conditions of Preapproval to be mandatory requirements.

### 16-A.7 System Updates (Optional)

Manufacturers may submit annual updates for retaining wall systems during January starting 2013. System updates are required to change the limits of Agency retaining wall systems preapproval.

System updates shall provide the following information:

- Manufacturer name;
- Retaining Wall System Name(s);
- Contact Person name and signature;



- Contact phone;
- Contact Address;
- Contact email;
- Description of proposed changes to reapproved design and construction method, or confirmation that preapproved design and construction methods have not changed; and
- Description of changes to formulation of the preapproved system, or confirmation that formulation of the preapproved system has not changed.

Send the annual update to:

Oregon Department of Transportation  
Geo-Environmental Section  
Engineering and Asset Management Unit  
4040 Fairview Industrial Dr. SE, MS 6  
Salem, OR 97302  
Phone: 503.986.3252 Fax: 503.986.3249

## **16-A.8 Disqualification and Requalification**

### **Disqualification**

The Retaining Structures Program reserves the right to disqualify proprietary retaining wall systems (remove from “preapproved” status) for:

- Non-conformance with preapproved design and construction methods;
- Non-conformance with Agency requirements; and
- Documented history of poor field performance.

### **Requalification**

The Retaining Structures Program will re-evaluate a product that has been disqualified (removed from “preapproved” status) only after submission of a formal request along with acceptable evidence that the problems causing the disqualification have been resolved.

## Appendix 16-B Preapproval Process and Submittal Requirements for Proprietary Retaining Wall Systems:

As noted in Section 15.1.1, “Preapproved” status of proprietary retaining wall systems that were preapproved prior to January 5, 2009 will expire on July 1, 2010. Proprietary retaining wall system preapprovals obtained prior to January 5, 2009 were based on the *ODOT Retaining Structures Manual*, and do not meet current requirements of the ODOT GDM. Proprietary retaining wall systems must obtain “preapproved” status or “preapproved-temporary” status based on the *ODOT GDM*, and be listed in [Appendix 16-D](#), to be considered on Agency projects with bid dates occurring after July 1, 2010.

To apply for *ODOT GDM* based preapproval of retaining wall systems that were not preapproved by the Agency prior to January 5, 2009 (“new systems”), submit an application for preapproval according to [Appendix 16-B.2.1](#). To apply for *ODOT GDM* based preapproval of retaining wall systems that were preapproved by the Agency prior to January 5, 2009 (“existing systems”), submit an application for preapproval according to [Appendix 16-B.2.2](#).

Preapproval of both “new systems” and “existing systems” will be based on a detailed system review in accordance with the *ODOT GDM*. Once preapproved, proprietary retaining wall systems will be listed as “preapproved” in [Appendix 16-D](#). During system review, (after Agency acceptance of their preapproval application), “existing systems” will also be listed as “preapproved-temporary.”

The “conditions of preapproval” for walls with either “preapproved” or “preapproved-temporary” status will be listed in [Appendix 16-D](#). The “conditions of preapproval” for “existing systems” with “preapproved-temporary” status will be consistent with prior Agency preapproval.

“Preapproved-temporary” status will only remain effective until the Agency determines that an adequate number of proprietary retaining wall systems have undergone a detailed system review, and been preapproved in accordance with the *ODOT GDM*, at which time all proprietary retaining wall systems with temporary preapproval will be removed from the list of preapproved retaining wall systems until they obtain “preapproved” status from the agency.

### 16-B.1 Preapproval Process:

#### **Step A: Manufacturer Submits Application**

Conditions for acceptance of applications:

- The application for preapproval must be for a single proprietary retaining wall system. A single wall system may include only one wall type (wall types are listed in [Section 16.2.2](#)). A single MSE wall system may include only one batter, one facing type, and one facing connection type.

- Applicant must own the proprietary retaining wall system or act as the sole representative of the proprietary retaining wall system owner for the purpose of obtaining Agency preapproval. Applicant must also provide system design and support.

Applications shall be submitted according to [Appendix 16-B.2.1](#) for “new systems”, or according to [Appendix 16-B.2.2](#) for “existing systems”.

Manufacturers may submit applications to the Agency at the address shown below.

Oregon Department of Transportation  
ODOT Geo Environmental  
Engineering and Asset Management Unit  
4040 Fairview Industrial Dry SE, MS #6  
Salem, OR 97302  
Phone 503-986-3252 Fax 503-986-3252

#### **Step B: Agency Reviews Application**

Written acknowledgement is sent to the applicant upon receipt of application.

Agency reviews the application, and does one of the following:

- Agency sends written notice to the Manufacturer that the application is accepted and provides any supplemental information and/or direction required for the manufacturer to prepare detailed system information for the proprietary retaining wall system described in the application.
- Agency sends written notice to the Manufacturer stating that the application has not been accepted, along with an explanation of why the application has not been accepted. The notice may request more information or clarification about the proprietary retaining wall system described in the application.

#### **Step C: Manufacturer Submits Detailed Information**

After the Agency accepts the manufacturer application the Manufacturer submit five sets of the detailed information required in [Appendix 16-B.3](#) (for MSE walls) [Appendix 16-B.4](#) (for prefabricated modular walls).

To help ODOT understand the functioning and performance of the technology and thereby facilitate the technical audit, applicants are urged to spend the time necessary to provide clear, complete and detailed responses. Missing or incomplete information will delay the Agency technical audit.

A response on all items that could possibly apply to the system or its elements and components, even those where evaluation procedures have not been fully established would be of interest to ODOT. Any omissions should be noted and explained.

Responses should be organized in the order shown and referenced to the given numbering system. Duplication of information is not needed or wanted. A simple statement referencing another section is adequate.

Prior to beginning the technical audit (Step D), the Agency will verify completeness of the submittal. The technical audit will not be started until the submittal is complete.

**Step D: Agency Performs System Technical Audit**

ODOT performs a technical audit of the manufacturer submittals. Preapproval will be based on the compliance with *ODOT GDM* requirements. Additional system information may be required from the system manufacturer during the system technical audit if needed to complete the technical audit.

**Step E: Agency Issues Findings**

Based on the findings of the Agency technical audit, the wall system will be preapproved in one or more of the three categories (Bridge, Highway, Minor), or it will be rejected. Rejected systems will be provided an explanation of items warranting the finding. If preapproved, the findings will be sent to the Manufacturer and posted in [Appendix 16-D](#).

## **16-B.2 Application for Preapproval of Retaining Wall System:**

### **16-B.2.1 “New System” Application:**

This option is only available for proprietary retaining wall systems that did not have Agency “preapproved” status prior to January 5, 2009. This application process places the system in the queue for full preapproval. “New systems” are not eligible for temporary approval.

Provide answers to the following questions, as applicable. Answers should follow the order of the questions, and each answer should reference the question number.

A. Applicant Identification

1. Company name
2. Name and title of authorized representative
3. Street Address
4. Email Address
5. Phone
6. Fax
7. Signature and date

B. Product Identification

1. Product or trade name (only one system per application)
2. Description. As part of the description, identify the retaining wall system type from the list in [Section 16.2.4.2](#), and describe the system. Indicate batter of the wall face.

3. Indicate which of the following categories of preapproval is being requested (see [Appendix 16-A](#) General Requirements for Proprietary Retaining Wall Systems).
    - a. Bridge Retaining Wall System (also indicate proposed maximum wall height).
    - b. Highway Retaining Wall System (also indicate proposed maximum wall height).
    - c. Minor Retaining Wall System.
  4. Indicate whether preapproval for tiered wall applications is being requested.
- C. Performance Criteria and History
1. Please write a brief history of the product's development, introduction, and acceptance to date. Where applicable, include a description of any predecessor products.
  2. Summarize any tests/evaluations already performed on the product, including the place, date, and result of testing. Attach copies of any available reports.
  3. Are there any issues other than functional performance that might be of significant interest or concern to a potential user (e.g. environmental acceptability, safety performance)?
- D. Proprietary Rights
1. Does the product involve proprietary technology?
  2. Is the product patented, copyrighted, or otherwise protected?
  3. If proprietary or patented technology is involved, please provide a summary description of the proprietary/protected features. Also indicate the date patented and the date the patent expires.
  4. If there is any specific information regarding your firm, the product, your application for preapproval, or any other matter that you wish to be treated as strictly confidential, please describe by categories or subject of confidential data how you would like the Agency to treat this data. Also, where appropriate, please describe any measures or safeguards that have been applied (or could be applied) to protect the confidentiality of the data.
- E. Organizational Structure
1. Please provide a brief description of the size, organizational structure, and technical resources of your company.
- F. HITEC or IDEA program

Please provide *Highway Innovative Technology Evaluation Center (HITEC) Technical Evaluation Report* for the retaining wall system, if available. Systems that do not have a HITEC evaluation

should pursue FHWA's new *Highway Innovations, Developments, Enhancements, and Advancements (IDEA) program technical review*. The IDEA program will be replacing the HITEC program.

### **16-B.2.2 “Existing System Application”:**

This option is only available for proprietary retaining wall systems that had Agency “preapproved” status prior to January 5, 2009. This application process places the system in the queue for full preapproval. “Existing systems” will also be listed as “preapproved-temporary” upon Agency acceptance of their preapproval application.

Please provide answers to the following questions, as applicable. Answers should follow the order of the questions, and each answer should reference the question number.

A. Applicant Identification

1. Company name
2. Name and title of authorized representative
3. Address
4. Phone
5. Fax
6. Signature and date

B. Product Identification

1. Product or trade name (only one system per application)
2. Description. As part of the description, identify the retaining wall system type from the list in [Section 16.2.4.2](#) and describe the system. Indicate batter of the wall face.
3. Indicate which of the following categories of preapproval is being requested (see [Appendix 16-A](#) General Requirements for Proprietary Retaining Wall Systems).
  - a. Bridge Retaining Wall System (also indicate proposed maximum wall height)
  - b. Highway Retaining Wall System (also indicate proposed maximum wall height)
  - c. Minor Retaining Wall System
4. Indicate whether preapproval for tiered wall applications is being requested.

C. Acknowledgement of ODOT GDM Implementation

1. In your application for preapproval, include a statement acknowledging that proprietary retaining wall systems with “preapproved-temporary” status must meet all requirements of the *ODOT Geotechnical Design Manual (GDM)*.

D. Performance Criteria and History

1. Please indicate the ODOT “index number” of the retaining wall system used in the *ODOT Retaining Structures Manual*, and date of preapproval.
  2. Please indicate any changes that have been made to the retaining wall system since preapproval.
  3. Please describe and explain any performance problems that have occurred with the retaining wall system.
- E. Proprietary Rights
1. Does the product involve proprietary technology?
  2. Is the product patented, copyrighted, or otherwise protected?
  3. If proprietary or patented technology is involved, please provide a summary description of the proprietary/protected features. Also indicate the date patented and the date the patent expires.
  4. If there is any specific information regarding your firm, the product, your application for preapproval, or any other matter that you wish to be treated as strictly confidential, please describe by categories or subject of confidential data how you would like the Agency to treat this data. Also, where appropriate, please describe any measures or safeguards that have been applied (or could be applied) to protect the confidentiality of the data.
- F. Organizational Structure
1. Please provide a brief description of the size, organizational structure, and technical resources of your company.
- G. HITEC or IDEA program
1. Please provide *Highway Innovative Technology Evaluation Center (HITEC) Technical Evaluation Report* for the retaining wall system, if available. Systems that do not have a HITEC evaluation should pursue FHWA’s new *Highway Innovations, Developments, Enhancements, and Advancements (IDEA) program technical review*. The IDEA program will be replacing the HITEC program.

## **16-B.3 Submittal Requirements for Proprietary MSE Retaining Wall Systems**

### **Instructions:**

To expedite the evaluation of the MSE Retaining Wall system, applicants must furnish information as indicated in the Checklist. The Checklist items should be referenced to assure that the submittal package includes all of the listed information. The submittal package should be organized according to the numbered items in the Checklist. The completed Checklist should be included with the submitted package.

**Part One:**

Identify material specification designations that govern the materials that are used in furnishing the wall system elements and components. Provide product literature that describes the wall system, its elements and components and adequately addresses the checklist items. Identify precast concrete facilities that have experience with fabricating the concrete elements and components of the wall system.

1.1 Concrete Facing Unit

Yes	No	N/A	
___	___	___	(a) Standard dimensions and tolerances
___	___	___	(b) Joint sizes
___	___	___	(c) Concrete strength
___	___	___	(d) Wet cast concrete percent air (range)
___	___	___	(e) Moisture absorption (percent by weight)
___	___	___	(f) Scaling resistance
___	___	___	(g) Freeze thaw durability
___	___	___	(h) Facing unit to facing unit shear resistance
___	___	___	(i) Bearing pads (joints)
___	___	___	(j) Spacers (pins, etc.)
___	___	___	(k) Joint filter requirements: geotextile or graded granular
___	___	___	(l) Aesthetic choices (texture, relief, color, graffiti treatment)
___	___	___	(m) Other facing materials



1.2 Earth reinforcement

1.2.1 Metallic

Yes	No	N/A	
___	___	___	(a) Type identified (welded wire, steel bars, etc.)
___	___	___	(b) Ultimate and yield strength of steel
___	___	___	(c) Minimum galvanization thickness
___	___	___	(d) Corrosion resistance test data

1.2.2 Geosynthetic

Yes	No	N/A	
___	___	___	(a) Polymer type and grade
___	___	___	(b) HDPE: resin type, class, grade and category
___	___	___	(c) Minimum intrinsic viscosity correlated to number of average molecular weight and maximum carboxyl end groups
___	___	___	(d) Weight per unit area
___	___	___	(e) Minimum average roll value for ultimate strength
___	___	___	(f) Creep reduction factor for 75 and 100 year design life, including effect of temperatures
___	___	___	(g) Durability reduction factor (chemical, hydrolysis, oxidation)
___	___	___	(h) Additional durability reduction factor for high biologically active environments
___	___	___	(i) Installation damage reduction factor for range of backfill (select backfill, course aggregate)
___	___	___	(j) UV resistance

1.3 Facing Connection(s)

Yes	No	N/A	
___	___	___	(a) Mode (structural, frictional or combined)
___	___	___	(b) Connection strength as a percentage of reinforcement strength at various confining pressures for each reinforcement product and connection type submitted
___	___	___	(c) Composition of devices, dimensions, tolerances
___	___	___	(d) Full scale connection test method/results

1.4 Range of Backfill

Yes	No	N/A	
—	—	—	(a) Soil classification, gradation, unit weight, friction angle for reinforcement method
—	—	—	(b) Soil classification, gradation, unit weight, friction angle for facing type

(Note: Backfill must meet AGENCY requirements.)

### 1.5 Leveling Pad

Yes	No	N/A	
—	—	—	(a) Cast-in-place
—	—	—	(b) Precast
—	—	—	(c) Granular

### 1.6 Drainage Elements

Yes	No	N/A	
—	—	—	(a) Modular Block Core and Drainage Backfill
—	—	—	(b) Pipe Drainage Backfill

### 1.7 Coping

Yes	No	N/A	
—	—	—	(a) Precast
—	—	—	(b) Precast attachment method/details
—	—	—	(c) Cast-in-place

### 1.8 Traffic Barrier

Yes	No	N/A	
—	—	—	(a) Precast
—	—	—	(b) Cast-in-place

### 1.9 Connections to Appurtenances

Yes	No	N/A	
—	—	—	(a) Precast

**Part Two: Design**

Clearly identify that the design conforms to the *AASHTO LRFD Bridge Design Specifications* and the GDM. Identify design assumptions and procedures with specific references (e.g., design code sections) for each of the listed items.

2.1 *AASHTO LRFD* Provisions

Yes	No	N/A	
___	___	___	(a) Sliding
___	___	___	(b) Overturning (including vehicle collision)
___	___	___	(c) Bearing resistance
___	___	___	(d) Compound stability
___	___	___	(e) Seismic
___	___	___	(f) Movement at service limit state
___	___	___	(g) Passive resistance and sliding
___	___	___	(h) Safety against structural failure
___	___	___	(i) Drainage

2.2 Performance Criteria

Yes	No	N/A	
___	___	___	(a) Erection tolerances
___	___	___	(b) Horizontal/vertical deflection limits

2.3 Drawings

Provide representative drawings showing all standard details along with any alternate details, as required in [Appendix 16-B.6](#).

Yes	No	N/A	
___	___	___	(a) Details

2.4 Specifications

Provide sample specifications for:

Yes	No	N/A	
___	___	___	(a) Wall system component materials

**2.5 Calculations**

Provide detailed calculations for the example problems in [Appendix 16-B.5](#). Explain all assumptions and calculations. Example problem calculations, including computer assisted analyses, shall be sealed and performed under the responsible charge of a Professional Engineer licensed in the State of Oregon.

Yes	No	N/A	
___	___	___	(a) Calculations

**2.6 Computer Support**

If a computer program is used to support vendor MSE wall designs, it shall be the latest version and latest update of MSEW (Adama Engineering, Inc.).

Yes	No	N/A	
___	___	___	(a) Computer programs used

**Part Three: Construction**

Provide the following information related to the construction of the system:

**3.1 Fabrication of Facing Units**

Yes	No	N/A	
___	___	___	(a) Curing methods
___	___	___	(b) Concrete surface finish requirements

**3.2 Field Construction Manual**

Provide a documented field construction manual describing in detail and with illustrations as necessary the step-by-step construction sequence, including requirements for:

Yes	No	N/A	
___	___	___	(a) Foundation preparation
___	___	___	(b) Special tools required
___	___	___	(c) Leveling pad
___	___	___	(d) Facing erection
___	___	___	(e) Facing batter for alignment
___	___	___	(f) Steps to maintain horizontal and vertical alignment
___	___	___	(g) Retained and backfill placement/compaction
___	___	___	(h) All equipment requirements

**3.3 Contractor or Subcontractor Prequalification Requirements**

List any contractor or subcontractor prequalification's.

Yes	No	N/A	
—	—	—	(a) Contractor prequalification's

**Part Four: Performance**

Provide the following information related to the performance of the system:

**4.1 Project Performance History**

Provide a well-documented history of performance (with photos, where available), including:

Yes	No	N/A	
—	—	—	(a) Oldest
—	—	—	(b) Highest
—	—	—	(c) Projects experiencing maximum measured settlement (total and differential) measurements of lateral movement/tilt
—	—	—	(d) Demonstrated aesthetics
—	—	—	(e) Maintenance history

## 16-B.4 Submittal Requirements for Proprietary Prefabricated Modular Retaining Wall Systems:

### Instructions:

To expedite the evaluation of the Prefabricated Modular Retaining Wall system, applicants must furnish information as indicated in the Checklist. The Checklist items should be referenced to assure that the submittal package includes all of the listed information. The submittal package should be organized according to the numbered items in the Checklist. The completed Checklist should be included with the submitted package.

### Part One:

Identify material specification designations that govern the materials that are used in furnishing the wall system elements and components. Provide product literature or other documentation that describes the wall system, its elements and components and adequately addresses the checklist items. Identify precast concrete facilities that have experience with fabricating the concrete elements and components of the wall system.

#### 1.1 Concrete Facing Unit

Yes	No	N/A	
___	___	___	(a) Standard dimensions and tolerances
___	___	___	(b) Joint sizes
___	___	___	(c) Concrete strength
___	___	___	(d) Wet cast concrete % air (range)
___	___	___	(e) Moisture absorption (percent by weight)
___	___	___	(f) Scaling resistance
___	___	___	(g) Freeze thaw durability
___	___	___	(h) Facing unit to facing unit shear resistance
___	___	___	(i) Bearing pads (joints)
___	___	___	(j) Spacers (pins, etc.)
___	___	___	(k) Joint filter requirements: geotextile or graded granular
___	___	___	(l) Aesthetic choices (texture, relief, color, graffiti treatment)
___	___	___	(m) Other facing materials

#### 1.2 Leveling Pad

Yes	No	N/A	
___	___	___	(a) Cast-in-place
___	___	___	(b) Precast
___	___	___	(c) Granular

**1.3 Drainage Elements**

Yes	No	N/A	
—	—	—	(a) Weep holes
—	—	—	(b) Base
—	—	—	(c) Backfill
—	—	—	(d) Surface

**1.4 Coping**

Yes	No	N/A	
—	—	—	(a) Precast
—	—	—	(b) Precast attachment method/details
—	—	—	(c) Cast-in-place

**1.5 Traffic Barrier**

Yes	No	N/A	
—	—	—	(a) Precast
—	—	—	(b) Cast-in-place

**1.6 Connections to Appurtenances**

Yes	No	N/A	
—	—	—	(a) Precast
—	—	—	(b) Precast attachment method/details
—	—	—	(c) Cast-in-place

**Part Two: Design**

Clearly identify that the design conforms to the *AASHTO LRFD Bridge Design Specifications*. Identify design assumptions and procedures with specific references (e.g., design code sections) for each of the listed items.

2.1 AASHTO LRFD Provisions

Yes	No	N/A	
___	___	___	(a) Sliding
___	___	___	(b) Overturning (including vehicle collision)
___	___	___	(c) Bearing resistance
___	___	___	(d) Overall stability
___	___	___	(e) Seismic
___	___	___	(f) Movement at service limit state
___	___	___	(g) Passive resistance and sliding
___	___	___	(h) Safety against structural failure
___	___	___	(i) Drainage

2.2 Performance Criteria

Yes	No	N/A	
___	___	___	(a) Erection tolerances
___	___	___	(b) Horizontal/vertical deflection limits

2.3 Drawings

Provide representative drawings showing all standard details along with any alternate details, as required in [Appendix 16-B.6](#).

Yes	No	N/A	
___	___	___	(a) Details

2.4 Specifications

Provide sample specifications for:

Yes	No	N/A	
___	___	___	(a) Wall system component materials



**2.5 Calculations**

Provide detailed calculations for the example problems in [Appendix 16-B.5](#). Explain all assumptions and calculations. Example problem calculations, including computer assisted analyses, shall be sealed and performed under the responsible charge of a Professional Engineer licensed in the State of Oregon.

Yes	No	N/A	
___	___	___	(a) Calculations

**2.6 Computer Support**

If a computer program is used for design of Agency projects, provide hand calculations for the required example problems demonstrating the reasonableness of computer results.

Yes	No	N/A	
___	___	___	(a) Computer program used

**Part Three: Construction**

Provide the following information related to the construction of the system:

**3.1 Fabrication of Facing Units**

Yes	No	N/A	
___	___	___	(a) Curing methods
___	___	___	(b) Concrete surface finish requirements

**3.2 Field Construction Manual**

Provide a documented field construction manual describing in detail and with illustrations as necessary the step-by-step construction sequence, including requirements for:

Yes	No	N/A	
___	___	___	(a) Foundation preparation
___	___	___	(b) Special tools required
___	___	___	(c) Leveling pad
___	___	___	(d) Facing erection
___	___	___	(e) Facing batter for alignment
___	___	___	(f) Steps to maintain horizontal and vertical alignment
___	___	___	(g) Retained and backfill placement/compaction
___	___	___	(h) Erosion mitigation
___	___	___	(i) All equipment requirements

**3.3 Contractor or Subcontractor Prequalification Requirements**

List any contractor or subcontractor prequalification's.

Yes	No	N/A	
___	___	___	(a) Contractor prequalification's

**Part Four: Performance**

Provide the following information related to the performance of the system:

4.1 Project Performance History

Provide a well-documented history of performance (with photos, where available), including:

Yes	No	N/A	
___	___	___	(a) Oldest
___	___	___	(b) Highest
___	___	___	(c) Projects experiencing maximum measured settlement (total and differential) measurements of lateral movement/tilt
___	___	___	(d) Demonstrated aesthetics possibilities
___	___	___	(e) Maintenance history

## 16-B.5 Proprietary Retaining Wall System Example Problems (by Preapproval Category):

### Introduction:

This appendix includes example problems that are referenced in [Appendix 16-B.3](#) and [Appendix 16-B.4](#).

Submit all calculations in LRFD format, in accordance with the *AASHTO LRFD Bridge Design Specifications*, as modified by the *ODOT GDM*, unless specified otherwise. Investigate all applicable limit states (load combinations), with load factors selected to produce the total extreme force effects. Loads stated in the example problems are all unfactored loads (unless noted otherwise), and require the Manufacturer to apply appropriate load factors.

Calculations and computer output for each example problem shall include or be accompanied by a design narrative. The design narrative shall define all variables, state and justify all design assumptions and interpretations, describe all design steps performed, show the results of each design step, and show that the results satisfy all applicable design requirements. Include references to all applicable GDM, AASHTO, and FHWA sections. Also provide dimensioned plans, details, and sectional views showing the retaining wall design for each example problem. Once a proprietary retaining wall system is preapproved, the solved example problems will become the standard for preparation of all project specific proprietary retaining wall submittals, as well as for Agency review of the Manufacturer submittals.

The example problems show an MSE retaining wall system. If the proposed proprietary retaining wall system is not an MSE retaining wall system, the Manufacturer should substitute the proposed wall type, in accordance with the requirements of the example problems.

Unless specified otherwise in the example problems, the Manufacturer shall select the wall height to be used in the example problem calculations (subject to *AASHTO* and *ODOT GDM* requirements). The wall height used in the example problems, if preapproved by ODOT, will become the maximum wall height allowed for the specific retaining wall system on Agency projects.

### **Required example problems (by category):**

- Highway retaining walls: Submit calculations for Retaining Wall Example Problems #1 and #2. Also submit Example Problem #4 when requesting preapproval for tiered Highway retaining wall applications.
- Bridge retaining walls: In addition to the calculations required for Highway retaining walls, submit calculations for Example Problem #3. Since the GDM does not allow the use of prefabricated modular bridge retaining walls, do not submit Example Problem #3 for proprietary prefabricated modular walls.
- Minor retaining walls: Submit calculations for Retaining Wall Example Problem #5 only. Proprietary minor retaining wall systems shall be one of the following retaining wall types:
  - Dry cast concrete block prefabricated modular retaining wall system (Type 2E);

- Wet cast concrete block prefabricated modular retaining wall system (Type 2F); or
- Gabion prefabricated modular retaining wall system (Type 2D).

**Retaining Wall Example Problem #1:**

- See [Figure 16-13](#) Problem # 1
- Wall is parallel to roadway
- Wall height: Maximum wall height for which preapproval is requested
- Design life: 75 years
- Backslope: Level
- Foreslope: Level
- EH Lateral earth pressure: Yes
- ES Earth surcharge load: No
- EV Vertical pressure from dead load of earth fill: Yes
- DC Component Dead Loads: Yes
- DW Dead load of future wearing surface: Assume DW = 50 psf
- EQ Earthquake loading:
  - Assume peak ground acceleration coefficient “PGA” = 0.22 g.
  - Assume “Site Class” is “D.”
  - Site adjusted seismic coefficient “ $A_s$ ” = 0.30 g.
  - Assume the Agency EOR has determined that the M-O method is applicable but that a reduction to  $A_s$  is not applicable (i.e.,  $k_h = A_s$ ).
  - Assume the load factor on live load equals 0.50 for the Extreme Event I limit state.
- CT Vehicular collision force for MSE walls. For this example problem:
  - Assume Type “F” (32 in.) traffic barrier coping with self-supporting moment slab (ODOT Standard Drawing BR760).
  - Design MSE walls to ensure soil reinforcements do not rupture or pullout due to vehicle impact loads on traffic railing in accordance with [Section 16.6.10](#).
  - The vehicular collision force shall be as specified in AASHTO LRFD 11.10.10.2 and the ODOT GDM.
  - Assume no load is transferred directly from the traffic barrier coping/moment slab to the wall facing.
- CT Vehicular collision force for prefabricated modular walls. For this example problem:

- Assume Type 2A Guardrail (see ODOT Standard Drawing RD400) with 5.0 ft. of embedment, and located at least three feet clear from the back of the wall.
- The vehicular collision force shall be as specified in AASHTO LRFD 11.10.10.2 and the ODOT GDM.
- Assume drained conditions for the reinforced soil, retained soil, and foundation soil.
- Assume reinforced backfill soil friction angle ( $\Phi_2$ ) = 34° (for MSE walls)
- Assume reinforced backfill cohesion ( $C_2$ ) = 0 psf (for MSE walls)
- Assume reinforced backfill unit weight ( $\gamma_2$ ) = 130 pcf (for MSE walls)
- Assume retained soil friction angle ( $\Phi_1$ ) = 32°
- Assume retained soil cohesion ( $C_1$ ) = 0 psf
- Assume retained soil unit weight ( $\gamma_1$ ) = 120 pcf
- Assume foundation soil friction angle ( $\Phi_3$ ) = 30°
- Assume foundation soil cohesion ( $C_3$ ) = 0 psf
- Assume foundation soil unit weight ( $\gamma_3$ ) = 120 pcf
- Assume wall embedment =  $H/20$  or 2.0 ft. (whichever is greater)
- Assume bearing resistance and settlement of foundation soils is acceptable for all limit states
- Assume overall stability does not govern reinforcement length (for MSE walls)

Figure 16-13 Problem # 1.

Problem #1

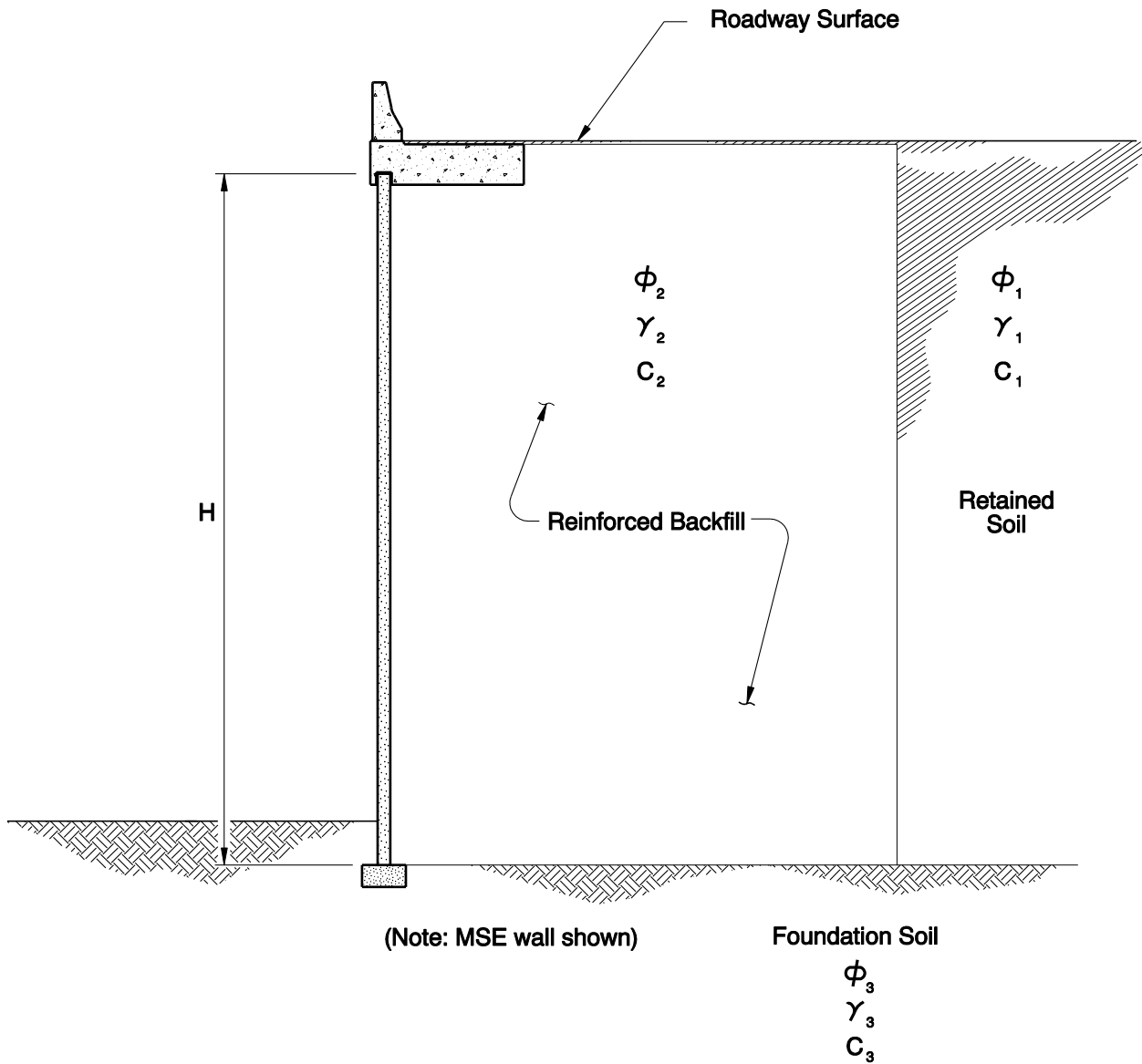

**Retaining Wall System Example Problem #2:**

- See [Figure 16-14](#) Problem # 2.
- Wall is parallel to roadway
- Wall height: Assume the maximum wall height for which preapproval is requested
- Design life: 75 years
- Backslope ( $\beta$ ): 1v:2h (assume length of slope is 100 ft.)
- Foreslope: Level
- EH Lateral earth pressure: Yes
- ES Earth surcharge load: No
- EV Vertical pressure from dead load of earth fill: Yes
- DC Component Dead Loads: Yes
- DW Dead load of future wearing surface: No
- LS Live load surcharge: No
- EQ Earthquake load:
  - Assume peak ground acceleration coefficient “PGA” = 0.22 g.
  - Assume “Site Class” is “D”.
  - Site adjusted seismic coefficient “ $A_s$ ” = “ $k_{max}$ ” = 0.30 g.
  - Assume the Agency EOR has determined the M-O method is not applicable.
  - Assume the total seismic thrust coefficient ( $K_{AE}$ ) was obtained using the GLE method in accordance with FHWA, 2009.
  - Assume the total seismic thrust coefficient ( $K_{AE}$ ) equals 1.00. No reduction to  $K_{AE}$  is applicable. Use  $K_{AE}$  to calculate the total seismic thrust ( $P_{AE}$ ), which includes both the active (static) thrust and the dynamic (seismic) thrust.
  - Calculate  $P_{AE}$  based on the height  $H_2 = H + [(0.5H \cdot \tan(\beta)) / (1 - 0.5 \cdot \tan(\beta))]$ , where H is shown in [Figure 16-14](#).
  - Assume the total seismic thrust ( $P_{AE}$ ) is applied at a height of  $H_2/2$  at the same inclination of the backslope (1v:2h).
- CT Vehicular collision force (on barrier): No
- Traffic Barrier at top of wall on barrier coping: No
- Standard cast in place concrete coping at top of wall: Yes
- Assume drained conditions in reinforced soil, retained soil, and foundation soil
- Assume reinforced backfill soil friction angle ( $\Phi_2$ ) = 34° (for MSE walls)

- Assume reinforced backfill cohesion ( $C_2$ ) = 0 psf (for MSE walls)
- Assume reinforced backfill unit weight ( $\gamma_2$ ) = 130 pcf (for MSE walls)
- Assume retained soil and cover friction angle ( $\Phi_1$ ) = 32°
- Assume retained soil and cover cohesion ( $C_1$ ) = 0 psf
- Assume retained soil and cover unit weight ( $\gamma_1$ ) = 120 pcf
- Assume foundation soil friction angle ( $\Phi_3$ ) = 30°
- Assume foundation soil cohesion ( $C_3$ ) = 0 psf
- Assume foundation soil unit weight ( $\gamma_3$ ) = 120 pcf
- Assume wall embedment =  $H/20$  or 2.0 ft. (whichever is greater)
- Assume soil bearing resistance and settlement of foundation soils is acceptable for all limit states
- Check compound stability but assume overall stability is acceptable
- Assume overall stability does not govern reinforcement length (for MSE walls)



Figure 16-14 Problem # 2.

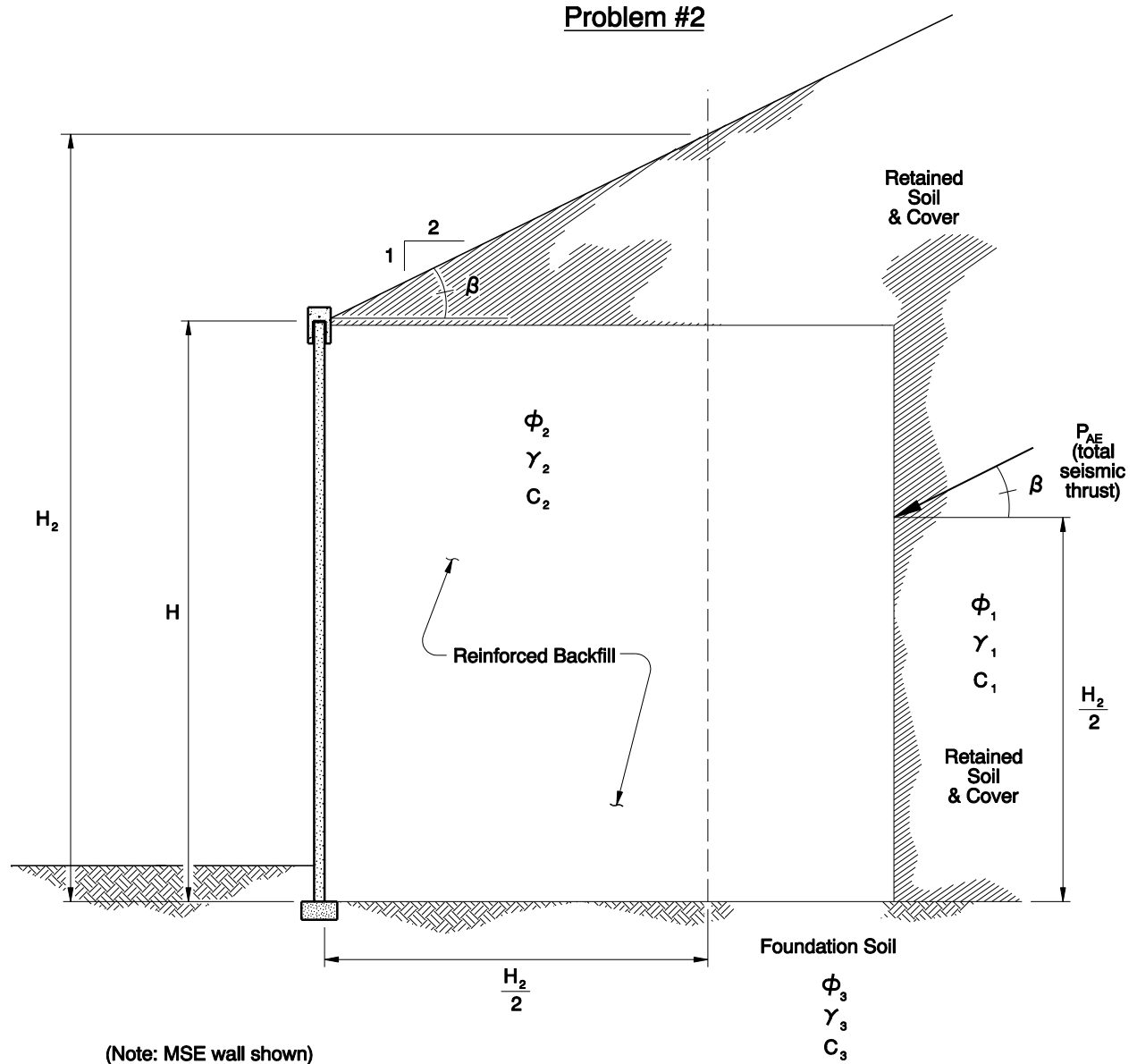

**Retaining Wall System Example Problem #3:**

- See [Figure 16-15](#) Problem # 3.
- Wall is transverse to upper roadway (not “U” or “L” shaped).
- Assume wall height “H” = 22.0 ft.
- Design life: 75 years
- Backslope: Level
- Foreslope: Level
- EH Lateral earth pressure: Yes
- ES Earth surcharge load: Unfactored bridge reactions on spread footing are as follows:
  - $P_v$  (dead) = 3.50 k/(ft. of wall)
  - $P_v$  (live) = 3.50 k/(ft. of wall)
  - $P_h$  (seismic, normal to wall) = 1.00 k/(ft. of wall)
- EV Vertical pressure from dead load of earth fill: Yes
- DC Component Dead Loads: Yes
- LS Live load surcharge on bridge approach: Yes
- EQ Earthquake load
  - Assume peak ground acceleration coefficient “PGA” = 0.22 g.
  - Assume “Site Class” is “D”.
  - (Site adjusted seismic coefficient “ $A_s$ ” = 0.30 g).
  - Assume the Agency EOR has determined that the M-O method is applicable but that a reduction to  $A_s$  is not applicable (i.e.,  $k_h = A_s$ ).
  - Assume the load factor on live load equals 0.50 for the Extreme Event I limit state.
- Assume drained conditions in reinforced soil, retained soil, and foundation soil
- Assume reinforced backfill soil friction angle ( $\Phi_2$ ) = 34° (for MSE walls)
- Assume reinforced backfill cohesion ( $C_2$ ) = 0 psf (for MSE walls)
- Assume reinforced backfill unit weight ( $\gamma_2$ ) = 130 pcf (for MSE walls)
- Assume retained soil friction angle ( $\Phi_1$ ) = 32°
- Assume retained soil cohesion ( $C_1$ ) = 0 psf
- Assume retained soil unit weight ( $\gamma_1$ ) = 120 pcf
- Assume foundation soil friction angle ( $\Phi_3$ ) = 30°
- Assume foundation soil cohesion ( $C_3$ ) = 0 psf

- Assume foundation soil unit weight ( $\gamma_3$ ) = 120 pcf
- Assume wall embedment =  $H/10$  or 2.0 ft. (whichever is greater)
- Assume the bearing resistance and settlement of foundation soil is acceptable for all limit states
- Check compound stability but assume overall stability is acceptable
- Assume overall stability does not govern reinforcement length (for MSE walls)

Figure 16-15 Problem # 3.

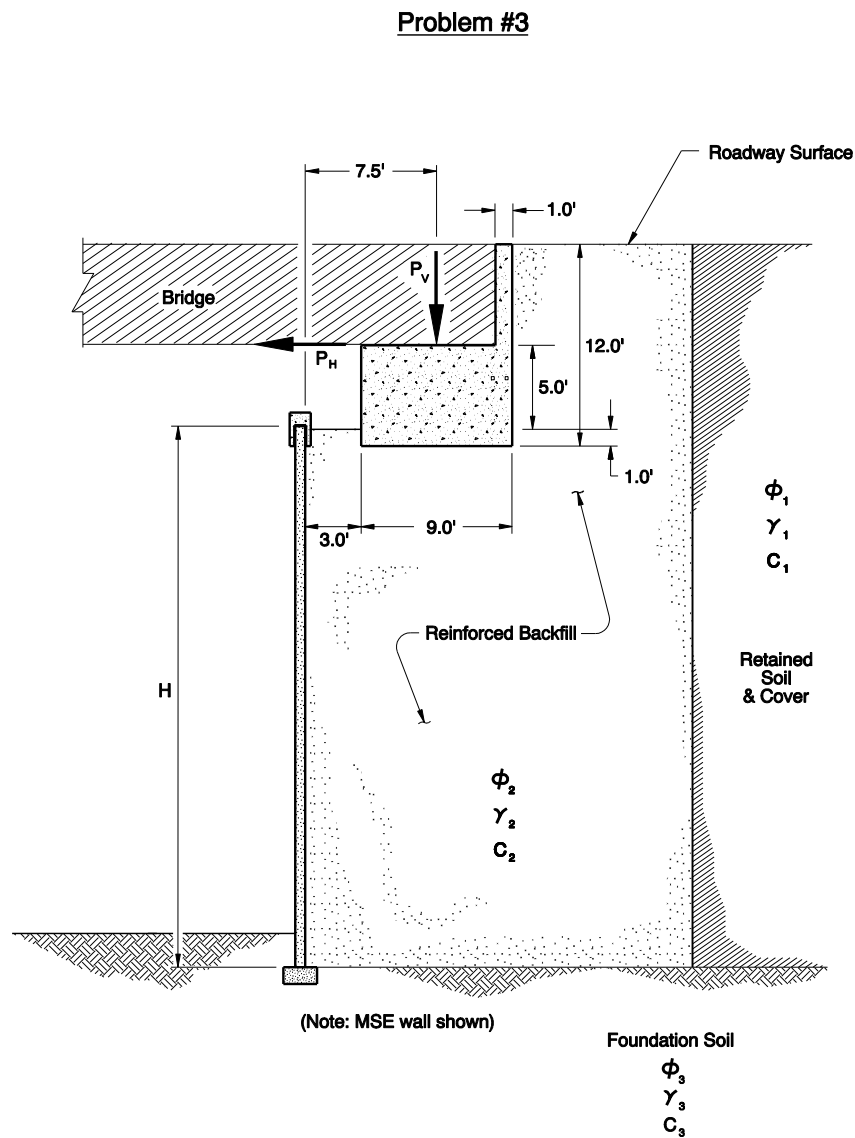

Retaining Wall System Example Problem #4

- See [Figure 16-16](#) Problem #4.

- Walls are parallel to roadway
- Wall heights:
  - Assume total wall height “H” is the maximum wall heights for which preapproval is requested.
  - Assume  $H_1 = H_2 = H/2$
- Design life: 75 years
- Backslope (upper wall): Level
- Backslope (lower wall): Level
- Foreslope (lower wall): Level
- EH Lateral earth pressure: Yes
- ES Earth surcharge load: Upper wall on lower wall
- EV Vertical pressure from dead load of earth fill: Yes
- DC Component Dead Loads: Yes
- DW Dead load of future wearing surface: Assume DW = 50 psf
- LS Live load surcharge: Yes
- EQ Earthquake load:
  - Assume peak ground acceleration coefficient “PGA” = 0.22 g.
  - Assume “Site Class” is “D”.
  - Site adjusted seismic coefficient “ $A_s$ ” = 0.30 g.
  - Assume the Agency EOR has determined that the M-O method is applicable but that a reduction to  $A_s$  is not applicable (i.e.,  $k_h = A_s$ ).
  - Assume the load factor on live load equals 0.0 for the Extreme Event I limit state.
- CT Vehicular collision force for MSE walls - For this example problem:
  - Assume Type “F” (32 in.) traffic barrier coping with self-supporting moment slab (ODOT Standard Drawing BR760).
  - Design MSE walls to ensure soil reinforcements do not rupture or pullout due to vehicle impact loads on traffic railing in accordance with [Section 15.6.10](#).
  - The vehicular collision force shall be as specified in AASHTO LRFD 11.10.10.2 and the ODOT GDM.
  - Assume no load is transferred directly from the traffic barrier coping/moment slab to the wall facing.
- CT Vehicular collision force for prefabricated modular walls. For this example problem

- Assume Type 2A Guardrail (see ODOT Standard Drawing RD400) with 5.0 ft. of embedment, located at least 3.0 ft. clear from the back of the wall.
- The vehicular collision force shall be as specified in AASHTO LRFD Section 11.10.10.2 and the ODOT GDM.
- Standard cast in place concrete coping at top of walls: No
- Assume drained conditions for reinforced soil, retained soil, and foundation soil
- Assume reinforced backfill soil friction angle ( $\Phi_2$ ) = 34° (for MSE walls)
- Assume reinforced backfill cohesion ( $C_2$ ) = 0 psf (for MSE walls)
- Assume reinforced backfill unit weight ( $\gamma_2$ ) = 130 pcf (for MSE walls)
- Assume retained soil friction angle ( $\Phi_1$ ) = 32°
- Assume retained soil cohesion ( $C_1$ ) = 0 psf
- Assume retained soil unit weight ( $\gamma_1$ ) = 120 pcf
- Assume foundation soil friction angle ( $\Phi_3$ ) = 30°
- Assume foundation soil cohesion ( $C_3$ ) = 0 psf
- Assume foundation soil unit weight ( $\gamma_3$ ) = 120 pcf
- Assume lower wall embedment =  $H/20$  or 2 ft., whichever is greater
- Assume upper wall embedment = 1.0 ft.
- Assume foundation soil bearing resistance and settlement are acceptable at all applicable limit states.
- Check compound stability, but assume overall stability is acceptable
- Assume overall stability does not govern reinforcement length (for MSE walls)

Figure 16-16 Problem # 4.

**Problem #4**

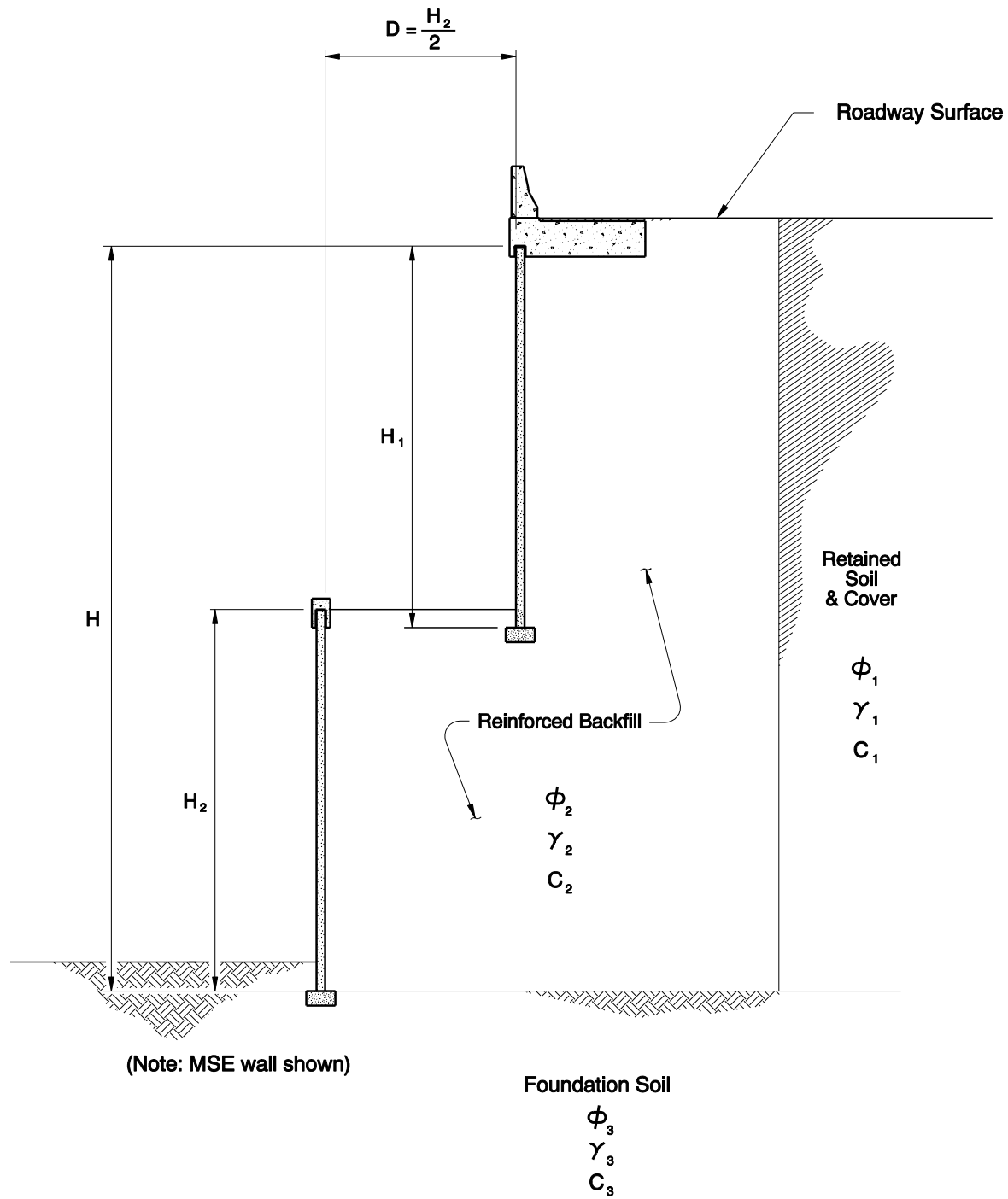

**Retaining Wall System Example Problem #5:**

- See [Figure 16-17 Problem #5](#).
- See [Section 16.3.23](#).
- Wall is parallel to roadway
- Wall height: 4.0 ft.
- Design life: 75 years
- Backslope: Level
- Foreslope: Level
- EH Lateral earth pressure: Yes
- ES Earth surcharge load: No
- EV Vertical pressure from dead load of earth fill: Yes
- EQ Earthquake load: No
- DC Component Dead Loads: Yes
- DW Dead load of future wearing surface: No
- LS Live load surcharge: No
- CT Vehicular collision force: No
- Assume drained conditions in retained and foundation soil
- Assume gravel leveling pad angle of internal friction is equal to  $34^\circ$
- Assume the foundation soil (below the leveling pad) is noncohesive soil with angle of internal friction equal to  $30^\circ$
- Assume retained soil friction angle ( $\Phi_1$ ) =  $34^\circ$
- Assume retained soil cohesion ( $C_1$ ) = 0 psf
- Assume retained soil unit weight ( $\gamma_1$ ) = 120 pcf
- Assume wall embedment: 0.5 ft.
- Assume foundation soil bearing resistance and settlement are acceptable for all limit states
- Assume overall stability is acceptable
- Assume the active earth pressure coefficient ( $k_a$ ) = 0.31
- Base coefficient of friction = 0.45 when designing sliding stability

Figure 16-17 Problem # 5.

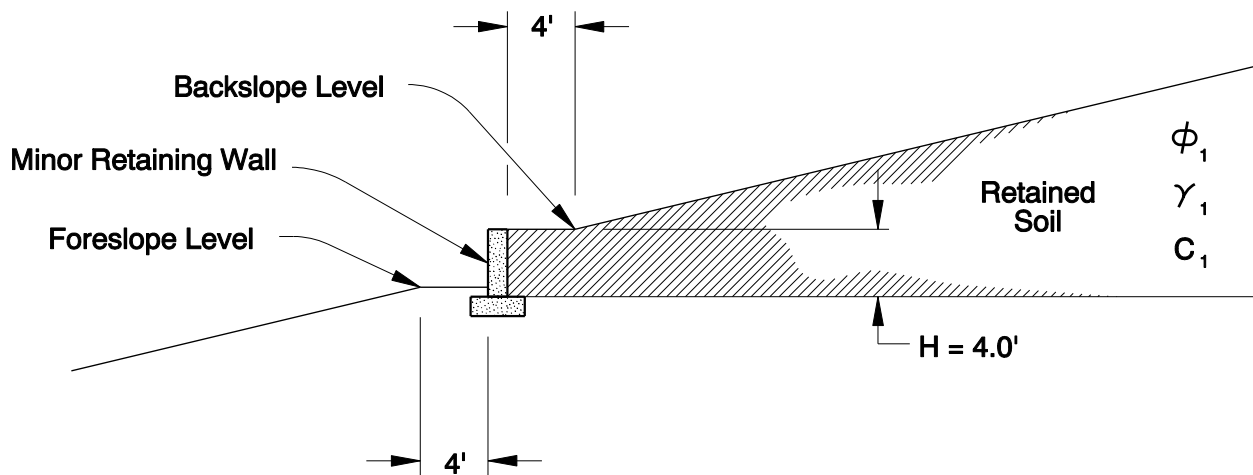
Problem #5

## 16-B.6 Requirements for Proprietary Retaining Wall System Detail Drawings (by Preapproval Category):

Provide the following drawings for proprietary retaining wall systems (as a minimum):

### 16-B.6.1 Bridge Retaining Wall Systems

- Wall elements
- Connection details
- Details at bridge abutment
- Appurtenance connection details
- Obstruction avoidance details
- Corrosion protection details
- Basic wall construction details
- Roadway drainage inlet details
- Drainage swale at top of wall
- Typical drainage details behind wall
- Culverts through wall
- Sidewalk at top of wall
- Pedestrian rail at top of wall



- Fencing at top of wall
- Traffic barrier at top of wall
- Guardrail at top of wall
- Standard coping
- Barrier coping
- Leveling pad or other base details
- Backfill reinforcement details (MSE walls)

### **16-B.6.2 Highway Retaining Wall Systems**

- Wall elements
- Connection details
- Appurtenance connection details
- Obstruction avoidance details
- Corrosion protection details
- Basic wall construction details
- Roadway drainage inlet details
- Drainage swale at top of wall
- Typical drainage details behind wall
- Culverts through wall
- Sidewalk at top of wall
- Pedestrian rail at top of wall
- Fencing at top of wall
- Traffic barrier at top of wall
- Guardrail at top of wall
- Standard coping
- Barrier coping
- Sidewalk coping
- Leveling pad or other base details
- Backfill reinforcement details (MSE walls)

### **16-B.6.3 Minor Retaining Wall Systems**

Basic wall construction details

Typical drainage details at heel of wall

## Appendix 16-C Guidelines for Review of Proprietary Retaining Wall System Working Drawings and Calculations

Review contract plans, special provisions, applicable Standard Specifications, any contract addenda, [Appendix 16-D](#) for the specific wall system proposed in the shop drawings, and [Appendix 16-A](#) as preparation for reviewing the shop drawings and supporting documentation. In addition, review Chapter 16 and the applicable *AASHTO LRFD* design specifications as needed to be fully familiar with the design requirements. If a HITEC or IDEA report is available for the wall system, it should be reviewed as well.

The shop drawings and supporting documentation should be quickly reviewed to determine whether or not the submittal package is complete. Identify any deficiencies in terms of the completeness of the submittal package. The shop drawings should contain wall plans for the specific wall system, elevations, and component details that address all of the specific requirements for the wall as described in the contract documents. The supporting documentation should include calculations supporting the design of each element of the wall (e.g., soil reinforcement design, corrosion design, connection design, facing structural design, external wall stability, special design around obstructions in the reinforced backfill, etc.) and example hand calculations demonstrating the method used by any computer printouts provided that verify the accuracy of the computer output. The contract will describe specifically what is to be included in the submittal package.

### 16-C.1 Geotechnical Design Issues

The following design issues should have already been addressed by the Geotechnical Engineer of Record in the development of the contract requirements:

- Design parameters are appropriate for the site soil/rock conditions
- Wall is stable for overall stability and compound stability (service and extreme event limit states)
- Settlement is within acceptable limits for the specific wall type(s) allowed by the contract (service limit state)
- The design for any mitigating measures to provide adequate bearing resistance, overall stability, compound stability, to address seismic hazards such as liquefaction consistent with the policies provided in [Chapter 7](#) of the *ODOT GDM*, and to keep settlement within acceptable tolerances for the allowed wall is fully addressed (service, strength and extreme event limit states)
- The design for drainage of the wall, both behind and within the wall, has been completed and is implemented to insure long-term drainage

## 16-C.2 External Stability Design

### 16-C.2.1 Structure Geometry

Are the structure dimensions, design cross-sections, and any other requirements affecting the design of the wall consistent with the contract requirements? As a minimum, check wall length, top elevation (both coping and barrier, if present), finished ground line elevation in front of wall, horizontal curve data, and locations and size of all obstructions (e.g., utilities, drainage structures, sign foundations, etc.) in the reinforced backfill, if any are present.

### 16-C.2.2 Design Procedure

Has the correct design procedure been used, including the correct earth pressures, earth pressure coefficients, and any other input parameters specified in the contract, both for static and seismic design?

### 16-C.2.3 Load Combinations

Have appropriate load combinations for each limit state been selected?

### 16-C.2.4 Load Factors

Have the correct load factors been selected, both in terms of magnitude and for those load factors that have maximum and minimum values, has the right combination of maximum and minimum values been selected?

### 16-C.2.5 Live Load

Has live load been treated correctly regarding magnitude and location (over reinforced zone for bearing, behind reinforced zone for sliding and overturning)?

### 16-C.2.6 Seismic

Have the correct PGA,  $A_s$ ,  $k_h$ , and  $k_v$ , been used for seismic design?

### 16-C.2.7 Resistance Factors

Have the correct resistance factors been selected for each limit state, and is the wall stable against sliding?

### 16-C.2.8 Soil Properties

Have the correct soil properties been used in the analyses (reinforced zone properties and retained fill properties)?

## 16-C.2.9 External Loads

Have the required external loads been applied in the analysis (external foundation loads, soil surcharge loads, etc.)?

## 16-C.2.10 Wall Widths

Have minimum specified wall widths (i.e., *AASHTO LRFD* specified minimum reinforcement lengths, *ODOT GDM, Chapter 15* specified minimum reinforcement lengths, and minimum reinforcement lengths specified to insure overall stability), in addition to those required for external and internal stability, been met in the final wall design?

## 16-C.2.11 Wall Embedment

Does the wall embedment meet the minimum embedment criteria specified?

## 16-C.2.12 Bearing Stresses

Are the maximum factored bearing stresses less than or equal to the factored bearing resistance for the structure for all limit states (service, strength, and extreme event)?

## 16-C.2.13 Computer Output Checks

Has the computer output been hand checked to verify the accuracy of the computer program calculations (compare hand calculations to the computer output; also, a spot check calculation by the reviewer may also be needed if the calculations do not look correct for some reason)?

## 16-C.2.14 Special Design Requirements

Have all the special design requirements specified in the contract that are in addition to the *ODOT GDM* and *AASHTO LRFD Specification* requirements been implemented in the Manufacturer's design?

## 16-C.2.15 Design Documents and Plan Details

Have the design documents and plan details been certified in accordance with the contract?

## 16-C.3 Internal Stability Design

### 16-C.3.1 Design Procedure

Has the correct design procedure been used, including the correct earth pressures and earth pressure coefficients?

### 16-C.3.2 Load Combinations

Have the appropriate load combinations for each limit state been selected?

### 16-C.3.3 Load Factors

Have the correct load factors been selected?

### 16-C.3.4 Live Load

Have live load been treated correctly regarding magnitude and location (over reinforced zone for bearing, behind reinforced zone for sliding and overturning)?

### 16-C.3.5 External Surcharge Loads

Have the effects of any external surcharge loads, including traffic barrier impact loads, been taken into account in the calculation of load applied internally to the wall reinforcement and other elements?

### 16-C.3.6 Seismic

Have the correct seismic parameters been used for seismic design for internal stability?

### 16-C.3.7 Resistance Factors

Have the correct resistance factors been selected for design for each limit state?

### 16-C.3.8 Reinforcement and Connector Properties

Have the correct reinforcement and connector properties been used?

- For steel reinforcement, have the steel reinforcement dimensions and spacing been identified?
- For steel reinforcement, has it been designed for corrosion using the correct corrosion rates, correct design life (75 years, unless specified otherwise in the contract documents)?
- Have the steel reinforcement connections to the facing been designed for corrosion, and has appropriate separation between the soil reinforcement and the facing concrete reinforcement been done so that a corrosion cell cannot occur, per the *AASHTO LRFD Specifications*?
- For geosynthetic reinforcement products selected, are the long-term design nominal strengths,  $T_{al}$ , used for design consistent with the values of  $T_{al}$  provided in the *ODOT Qualified Products List (QPL)*?
- Is the use of soil reinforcement - facing connection design parameters consistent with the connection plan details provided? For steel reinforced systems, such details include the shear resistance of the connection pins or bolts, bolt hole sizes, etc. For geosynthetic reinforced systems, such details include the type of connection, and since the connection strength is specific to the reinforcement product (i.e., product material, strength, and type) – facing unit (i.e., material type and strength, and detailed facing unit geometry) combination, and the specific type of connector used, including material type and connector geometry, as well as how it fits with the facing unit. Check to make sure that

the reinforcement – facing connection has been previously approved and that the approved design properties have been used.

- If a coverage ratio,  $R_c$ , of less than 1.0 is used for the reinforcement, and its connection to the facing, has the facing been checked to see that it is structurally adequate to carry the earth load between reinforcement connection points without bulging of facing units, facing unit distress, or overstressing of the connection between the facing and the soil reinforcement?
- Are the facing material properties used by the wall supplier consistent with what is required to produce a facing system that has the required design life and that is durable in light of the environmental conditions anticipated? Have these properties been backed up with appropriate supporting test data? Is the facing used by the supplier consistent with the aesthetic requirements for the project?

### 16-C.3.9 Limit States

Check to make sure that the following limit states have been evaluated, and that the wall internal stability meets the design requirements:

- Reinforcement resistance in reinforced backfill (strength and extreme event)
- Reinforcement resistance at connection with facing (strength and extreme event)
- Reinforcement pullout (strength and extreme event)

### 16-C.3.10 Obstructions

If obstructions such as small structure foundations, culverts, utilities, etc., must be placed within the reinforced backfill zone (primarily applies to MSE walls), has the design of the reinforcement placement, density and strength, and the facing configuration and details to accommodate the obstruction been accomplished in accordance with the *ODOT GDM* and *AASHTO LRFD* specifications.

### 16-C.3.11 Computer Output

Has the computer output for internal stability been hand checked to verify the accuracy of the computer program calculations (compare hand calculations to the computer output; also, a spot check calculation by the reviewer may also be needed if the calculations do not look correct for some reason)?

### 16-C.3.12 Specific Requirements

Have the specific requirements, material properties, and plan details relating to internal stability specified in the sections that follow been used?

### 16-C.3.13 Structural Design and Detail Review

Note that for structural wall facings for MSE walls, design of prefabricated modular walls, and design of other structural wall systems, a structural design and detail review should be conducted in accordance with the *AASHTO LRFD Specifications*.

- Compare preapproved wall details to the shop drawing regarding the concrete facing panel dimensions, concrete cover, rebar size, orientation and location. This also applies to any other structural elements of the wall (e.g., steel stiffeners for welded wire facings, concrete elements and components of modular walls whether reinforced or not, etc.).
- Do the geometry and dimensions of any traffic barriers or coping shown on shop drawings match with what is required by contract drawings (may need to check other portions of contract plans for verification? Has the structural design and sizing of the barrier/reaction slab been done consistently with the AASHTO specifications? Are the barrier details constructible?
- Do notes in the shop drawings state the date of manufacture, production lot number, and piece mark be marked clearly on the rear face of each panel (if required by special the contract provisions)?

## **16-C.4 Wall Construction Sequence Requirements**

Wall construction sequence and requirements provided in shop drawings should follow the guidelines defined in the next sections.

### **16-C.4.1 Construction Sequence**

Make sure construction sequence and notes provided in the shop drawings do not conflict with the contract specifications (e.g., minimum lift thickness, compaction requirements, construction sequence and details, etc.). Any conflicts should be pointed out in the shop drawing review comments.

### **16-C.4.2 Preapproved Details and Contract Requirements**

Make sure any wall/slope corner or angle point details are consistent with the preapproved details and the contract requirements, both regarding the facing and the soil reinforcement. This also applies to overlap of reinforcement for back-to-back walls.

# Appendix 16-D Preapproved Proprietary Retaining Wall Systems

Last updated 07/01/2022

Proprietary System	Manufacturer	Wall Type per GDM Section 15.2.4.2	Wall facing	Soil reinforcement type (MSE only)	Minimum possible batter from vertical (0.0° is vertical)	Bridge wall maximum preapproved height (ft)	Highway wall maximum preapproved height (ft)	Minor wall maximum Preapproved height (ft)	Preapproval of Highway walls for 1: 2 (v: h) backslopes?	Preapproval of Tiered walls where lower tier is loaded by upper wall (see GDM 15.6.13)?	Preapproval Status	Other Conditions of Preapproval
Allan Block AB3® (MSE system)	Oregon Block and Paver MFG (541) 233-7856	3A	hollow core dry cast modular block	geogrid	3.0°	n.a.	32	n.a.	yes	yes	Preapproved	Must use AB3 units; Must use geogrid from ODOT QPL; Must use geogrid design values per ODOT QPL; Must use block/geogrid combinations with valid connection test data to support the design; See Note 1; See Note 2.
Allan Block AB6® (MSE system)	Oregon Block and Paver MFG (541) 233-7856	3A	hollow core dry cast modular block	geogrid	6.0°	n.a.	32	n.a.	yes	yes	Preapproved	Must use AB6 units; Must use geogrid from ODOT QPL; Must use geogrid design values per ODOT QPL; Must use block/geogrid combinations with valid connection test data to support the design; See Note 1; See Note 2.
Allan Block AB6® (Gravity system)	Oregon Block and Paver MFG (541) 233-7856	2E	hollow core dry cast modular block	n.a.	6.0°	n.a.	4	4	no	no	Preapproved	Must use AB6 units; See Note 1.
Anchor Diamond (prefabricated modular system)	Anchor Wall Systems, Inc. (949) 363-6663	2E	solid core dry cast modular block	n.a.	10.6°	n.a.	4	4	no	no	Preapproved	Must use Diamond Straight Face units or Diamond Beveled Face units; Must use geogrid from ODOT QPL; See Note 1.
Anchor Vertica® (prefabricated modular system)	Anchor Wall Systems, Inc. (949) 363-6663	2E	hollow core dry cast modular block	n.a.	4.0°	n.a.	3.33	3.33	no	no	Preapproved	Must use Vertica Straight Face units or Vertica Beveled Face units; See Note 1.
Anchor Vertica Pro® (prefabricated modular system)	Anchor Wall Systems, Inc. (949) 363-6663	2E	hollow core dry cast modular block	n.a.	4.0°	n.a.	4	4	no	no	Preapproved	Must use Vertica Pro Straight Face units or Vertica Pro Beveled Face units; See Note 1.
Keysteel™ SQ. Ft. Panel System (MSE system; formerly called Keysystem 1)	Keystone Retaining Wall Systems, A Contech Company (952) 897-1040	3A	hollow core dry cast modular block	HDG welded wire	0.5°	49	49	n.a.	yes	no	Preapproved-Temporary	Must use Keysteel Sq. Ft. units; See Note 1.



GEOTECHNICAL DESIGN MANUAL

Proprietary System	Manufacturer	Wall Type per GDM Section 15.2.4.2	Wall facing	Soil reinforcement type (MSE only)	Minimum possible batter from vertical (0.0° is vertical)	Bridge wall maximum preapproved height (ft)	Highway wall maximum preapproved height (ft)	Minor wall maximum Preapproved height (ft)	Preapproval of Highway walls for 1: 2 (v: h) backslopes?	Preapproval of Tiered walls where lower tier is loaded by upper wall (see GDM 15.6.13)?	Preapproval Status	Other Conditions of Preapproval
Artweld Gabion (prefabricated modular system)	Hilfiker Retaining Walls HW® (800)762-8962	2D	gabion	n.a.	0.0°	n.a.	15	4	yes	no	Preapproved-Temporary	See Note 1.
Reinforced Soil Emb. Shadow Panel (MSE system)	Hilfiker Retaining Walls HW® (800)762-8962	3D	2.0'x12.5' (VxH) precast panel	HDG welded wire	0.0°	0	30	n.a.	yes	no	Preapproved-Temporary	See Note 1.
Reinforced Soil Emb. Smooth Face (MSE system)	Hilfiker Retaining Walls HW® (800)762-8962	3C, 3D	5.0'x5.0' precast panel	HDG welded wire	0.0°	40	40	n.a.	yes	yes	Preapproved	See Note 1.
Welded Wire Wall (MSE system)	Hilfiker Retaining Walls HW® (800)762-8962	3E	welded wire	HDG welded wire	0.0°	0	33	n.a.	yes	yes	Preapproved	Must use exposed welded wire face; Vegetated face, gunite face covering, and shotcrete face covering not preapproved at this time; See Note 1.
Eureka Reinf. Soil (MSE system)	Hilfiker Retaining Walls HW® (800)762-8962	3G	welded wire with precast panel fascia	HDG welded wire	0.0°	30	30	n.a.	yes	no	Preapproved-Temporary	Must use Cast-in-place fascia; Precast fascia not preapproved at this time; See Note 1.
Reinforced Earth® (MSE system)	The Reinforced Earth® Company (303) 790-1481	3C, 3D	5'x5' Cruciform or square precast panels  5'x10' rectangular precast panels	HDG steel strip  (HDG welded wire not preapproved)	0.0°	40	40	n.a.	yes	no	Preapproved	In place of AASHTO default pullout friction factors, the following may be used with HDG steel strip and MSE Wall Granular Backfill: F* @ top = 3.0; linear to F* @ 20' = tanφ; F* @ below 20' = tanφ See Note 1.
Retained Earth® (MSE system)	The Reinforced Earth® Company (303) 790-1481	3C, 3D	5'x5' and 5'x10' precast panels	HDG welded wire	0.0°	40	40	n.a.	yes	no	Preapproved-Temporary	See Note 1.
Pyramid® (MSE system)	The Reinforced Earth® Company (303) 790-1481	3A	dry cast modular block	HDG welded wire	0.0°	0	20	n.a.	no	no	Preapproved-Temporary	See Note 1.
Terratrel® Concrete Clad Face	The Reinforced Earth® Company (303) 790-1481	3G	welded wire with CIP concrete fascia	HDG welded wire	0.0°	0	25	n.a.	yes	no	Preapproved-Temporary	Must use CIP concrete fascia

GEOTECHNICAL DESIGN MANUAL

Proprietary System	Manufacturer	Wall Type per GDM Section 15.2.4.2	Wall facing	Soil reinforcement type (MSE only)	Minimum possible batter from vertical (0.0° is vertical)	Bridge wall maximum preapproved height (ft)	Highway wall maximum preapproved height (ft)	Minor wall maximum Preapproved height (ft)	Preapproval of Highway walls for 1: 2 (v: h) backslopes?	Preapproval of Tiered walls where lower tier is loaded by upper wall (see GDM 15.6.13)?	Preapproval Status	Other Conditions of Preapproval
MSE Plus™ (precast panel face MSE system)	SSL™, LLC (831) 430-9300	3C, 3D	5'x5', 5'X6', 5'x10', and 5'x12' precast panels	HDG welded wire	0.0°	50	50	n.a.	yes	yes	Preapproved	See Note 1.
MSE Plus™ (welded wire wall MSE system)	SSL™, LLC (831) 430-9300	3E	welded wire	HDG welded wire	0.0°	n.a.	33	n.a.	yes	yes	Preapproved	Must use exposed welded wire face; Vegetated face, gunite face covering, and shotcrete face covering not preapproved at this time; See Note 1.
ARES® (MSE system)	Tensar® International Corp. (360) 779 5555	3C, 3D	5'x5' and 5'x9' precast panels	geogrid	0.0°	50	50	n.a.	yes	yes	Preapproved	Must use Type 3C or 3D facing; Full height panels not preapproved at this time; See Note 1; See Note 2.
MESA® (MSE system)	Tensar® International Corp. (360) 779 5555 B11	3A	hollow dry cast modular block	geogrid	0.5°	50	50	n.a.	yes	yes	Preapproved	Must use geogrid from ODOT QPL; Must use geogrid design values per ODOT QPL; Must use block/geogrid combinations with valid connection test data to support the design; See Note 1; See Note 2.
LANDMARK® (MSE system)	Anchor® Wall Systems, Inc. (949) 363-6663	3A	hollow dry cast modular block	geogrid	0.0°	n.a.	30	n.a.	yes	yes	Preapproved	Must use geogrid from ODOT QPL; Must use geogrid design values per ODOT QPL; Must use block/geogrid combinations with valid connection test data to support the design; See Note 1; See Note 2.
Ultrablock™ (prefabricated modular system)	Ultrablock, Inc. 800-377-3877	2F	wet cast modular block	n.a.	5.7°	n.a.	12	4	yes	no	Preapproved-Temporary	See Note 1;
Ultrablock™ (MSE system)	Ultrablock, Inc. 800-377-3877	3B	wet cast modular block	geogrid	0.0°	0	15	n.a.	no	no	Preapproved-Temporary	Only 0.0° (vertical) face batter preapproved; Must use geogrid from ODOT QPL; Must use geogrid design values per ODOT QPL; Must use block/geogrid combinations with valid connection test data to support the design; See Note 1; See Note 2.

GEOTECHNICAL DESIGN MANUAL

Proprietary System	Manufacturer	Wall Type per GDM Section 15.2.4.2	Wall facing	Soil reinforcement type (MSE only)	Minimum possible batter from vertical (0.0° is vertical)	Bridge wall maximum preapproved height (ft)	Highway wall maximum preapproved height (ft)	Minor wall maximum Preapproved height (ft)	Preapproval of Highway walls for 1: 2 (v: h) backslopes?	Preapproval of Tiered walls where lower tier is loaded by upper wall (see GDM 15.6.13)?	Preapproval Status	Other Conditions of Preapproval
GRAVIX® DOT Precast Wall System	Earth Wall Products (678) 594-3451	2G	5'x8' face 2' - 24' stem embedment length precast units	n.a.	0.0°	n.a.	32	n.a.	yes	no	Preapproved	See Note 1.
KeySystem III Retaining Wall System  (KeySystem III)	Keystone Retaining Wall Systems LLC (952) 837-8228	3A	hollow dry cast modular block	geogrid	1H:64V (<1')	n.a.	25	n.a.	yes	no	Preapproved	Must use geogrid from ODOT QPL; Must use geogrid design values per ODOT QPL; Perform calculations with sustained load connection test data for no pins in place, but construct KeySystem III MSE retaining wall system with fiberglass pins in place; See Note 1; See Note 2.
Note 1: All systems must meet the requirements of the ODOT GDM, AASHTO LRFD, Agency construction specifications.												
Note 2: Special height limits apply to Bridge retaining walls with geogrid soil reinforcement supporting loads from bridge abutment spread footings (see GDM 15.6.16).												

# Chapter 17 - Foundation Design



## Chapter Contents

<b>Chapter 17 - Foundation Design .....</b>	<b>17-1</b>
<b>17.1 General, Standards And Policies .....</b>	<b>17-4</b>
17.1.1 Definitions .....	17-4
17.1.2 Foundation Design Standards .....	17-5
17.1.3 Scour Design .....	17-7
17.1.4 Traffic Structures .....	17-7
17.1.5 End Bents .....	17-9
<b>17.2 Foundation Selection Criteria .....</b>	<b>17-10</b>
17.2.1 Spread Footings .....	17-10
17.2.2 Deep Foundations .....	17-11
<b>17.3 Seismic Design .....</b>	<b>17-12</b>
<b>17.4 Spread Footing Design .....</b>	<b>17-13</b>
17.4.1 Nearby Structures .....	17-13
17.4.2 Service Limit State Design of Footings .....	17-13
<b>17.5 Driven Pile Foundation Design .....</b>	<b>17-14</b>
17.5.1 Required Pile Tip Elevation .....	17-15
17.5.2 Pile Drivability Analysis and Wave Equation Usage .....	17-16
17.5.3 Pile Setup and Restrike .....	17-16
17.5.4 Driven Pile Types, and Sizes .....	17-17
17.5.5 Extreme Event Limit State Design .....	17-18
17.5.6 Scour Effects on Pile Design .....	17-18

17.5.7 Seismic Design for Pile Foundations .....	17-20
17.6 Drilled Shaft Foundation Design .....	17-22
17.6.1 Drilled Shaft Base Grouting .....	17-23
17.6.2 Nearby Structures .....	17-24
17.6.3 Scour .....	17-24
17.6.4 Extreme Event Limit State Design of Drilled Shafts .....	17-24
17.7 Micropiles .....	17-25
17.8 Traffic Structures .....	17-25
17.8.2 Cantilever Sign Foundations .....	17-29
17.8.3 Sign And VMS Bridge Foundations .....	17-30
17.8.4 Luminaire Supports .....	17-30
17.8.5 High Mast Luminaire Support .....	17-31
17.8.6 Sound Walls .....	17-31
17.8.7 Buildings .....	17-33
17.9 Construction Considerations .....	17-34
17.10 References .....	17-35

**List Of Tables**

Table 17-1 Type of Load, Foundation Type, and Method Used to Calculate Downdrag .....	17-7
Table 17-2 Traffic Structures Standards .....	17-8
Table 17-3 Traffic Structures Standards .....	17-25
Table 17-4 Minimum Lateral Embedment Depths for Standard Foundation of SM1 – SM5L Signal Poles in Cohesionless Soil when Groundwater is at Least 9 ft Below the Tip of the Foundation where $\gamma = 100$ pcf and $\phi = 26$ degrees and $k = 25$ pci .....	17-27
Table 17-5 Minimum Lateral Embedment Depth for Standard Foundation of SM1 – SM5L Signal Poles in Cohesionless Soil and with groundwater at the ground surface where $\gamma = 38$ pcf, $\phi = 26$ degrees, and $k = 20$ pci .....	17-27

**List Of Figures**

Figure 17-1 Design of pile foundations for scour .....	17-20
Figure 17-2 Design of pile foundations for liquefaction downdrag (WSDOT, 2006) .....	17-21
Figure 17-3 Rock Installation Requirements .....	17-28

**List of Equations**

Equation 17-1 .....	17-19
Equation 17-2 .....	17-19
Equation 17-3 .....	17-19

Equation 17-4 ..... 17-21  
Equation 17-5 ..... 17-21

## 17.1 General, Standards And Policies

This chapter covers the geotechnical design of foundations. Which includes abutment resistance for bridges, shallow (spread footings) and deep (driven piles and drilled shaft) foundations, traffic structures, illumination, camera poles, sound walls and buildings. Foundation design requires performing an office study, obtaining an appropriate level of subsurface exploration information for design and construction, performing foundation analyses and providing written recommendations in a report for the designer, the project team and the contractor. See [Chapter 3](#) for guidance on foundation information available through office studies and the procedures for conducting a thorough site reconnaissance. See [Chapter 4](#) for requirements for exploration for foundation design. See [Chapter 19](#) for foundation reporting requirements.

Unless otherwise stated in this manual, the Load and Resistance Factor Design approach (LRFD) shall be used for all foundation design projects, as prescribed in the most current version of the *AASHTO*. The ODOT foundation design policies and standards described in this chapter supersede those in the AASHTO LRFD specifications and FHWA design manuals. FHWA design manuals are encouraged for use in foundation design procedures and preferable in cases where foundation design procedures are not adequately provided in AASHTO. Structural design of bridge foundations, and other structure foundations, is addressed in the *ODOT Bridge Design Manual (BDM)*.

### 17.1.1 Definitions

**Auger Cast Piles** – also known as continuous flight auger (CFA) or drilled displacement pile “are a type of drilled foundation in the pile is drilled to the final depth using a continuous flight auger. As the auger is withdrawn from the hole concrete or grout is placed.

**Cast-In-Place Piles** – a predrilled excavation reinforced with a pile section that is concreted in-place. Sometimes referred to as a prebored pile.

**Cyclic Direct Simple Shear (CDSS) Test** – a shear strength test for evaluating the ability of soil to resist shear stresses induced in a soil mass during earthquake loading.

**Driven Piles** – a slender deep foundation, wholly or partly embedded in the ground, that is installed by driving, or otherwise and that derived its capacity from the surrounding soil and/or from the soil or rock strata below its tip. (AASHTO).

**Drilled Shafts** – a deep foundation unit, wholly or partly embedded in the ground, constructed by placing fresh concrete in a drilled hole with or without steel reinforcement. Drilled shafts derive their capacity from the surrounding soil and/or from the soil or rock strata below its tip. Drilled shafts are also commonly referred to as caissons, drilled caissons, bored piles, or drilled piers (AASHTO).

**Footings** – is an enlargement of the base of a column or wall for the purpose of transmitting the load to the subsoil” (Peck, Hanson, Thornburn, 1974).

**Foundation** – is part of a structure which has the primary function of transmitting loads from the structure to the natural ground. (Perloff and Baron, 1976).

**Micropiles** – a small-diameter drilled and grouted non-displacement pile (normally less than 12-in diameter) that is typically reinforced (AASHTO).

**Spread Footing** – also known as a shallow foundation it derives its support by transferring load directly to the soil or rock at a shallow depth (AASHTO).

## **17.1.2 Foundation Design Standards**

The following items are highlights of items that need additional time and attention during development and are listed below. In-depth design procedures are outlined in each individual sub-section. These highlights are here to hopefully bring clarity and draw attention to anomalies in the design of these items.

### **17.1.2.1 Drilled Shafts Greater than 6’ in Diameter**

Based on the high risk exposure to the Agency of high load carrying foundations the geotechnical investigation, design, integrity and load testing require augmented review by the State Geotechnical Engineer. Drilled shaft design greater than 6’ in diameter is required to be submitted at each phase gate, to State Geotechnical Engineer for review and concurrence. This provides time during project development to ensure appropriate subsurface investigation, design, and incorporate appropriate level of quality control during construction.

Documentation expected for review at each phase gate includes: plans, loads at limit states, estimated resistance plots, calculation book documenting methods, calculations, assumptions, and resistance factors at each limit state, construction quality control measures, and how loads will be verified. Statewide reviews with comments will be documented in the quality folder of the project and plan to respond within two weeks of receipt.

### **17.1.2.2 Augercast Piles**

Augercast piles can be very cost effective in certain situations. However, they present significant challenges with respect to verifying integrity and capacity. Therefore, it is ODOT current standard not to use augercast piles for bridge foundations.

### **17.1.2.3 Cast-In-Place Piles**

Cast-in-place piles may appear to be cost effective and easy to construct. However, they present significant challenges with respect to design, and use of consistent design methodology between the Geotechnical Engineer and the Bridge Engineer. During construction, verification



of integrity and capacity is not possible thus producing a foundation of unknown quality and unknown integrity with unknown capacity. Therefore, it is ODOT current standard not to use cast-in-place piles for bridge foundations.

### 17.1.2.4 CDSS Testing

Studies of Willamette Silt in Western Oregon were initiated in the mid-1990's and continue in an effort to determine the cyclic response of these unique soils which underlie the majority of Oregon's population. To better understand these soils specific sampling, and testing criteria is required to bolster the existing dataset of Willamette Silt data. If an ODOT STIP project can justify the cost of testing (~\$20k) with savings in project costs. Until recently, CDSS testing availability for ODOT projects was limited to resources outside the Country. Currently, there are several consulting firms and two Universities in Oregon that are able to perform this testing.

A paired mud rotary and CPT are required for site investigation. Undisturbed sampling, storage, and transport to the laboratory require careful handling as these transitional soils are subject to easy disturbance.

Testing protocol requires the following tests to be performed for each sample: index tests, soil classification with particle size distribution, constant rate-of-strain consolidation test where  $\sigma'_{vo} = \sigma'_{vc}$ , a minimum of four constant-volume, monotonic direct simple shear tests over a range of OCRs from 1 to 8, and a minimum of four constant-volume, stress-controlled, Cyclic Direct Simple Shear (CDSS) tests. All test results in the raw data form, in excel format, are stored in ProjectWise with the associated project. Geotechnical Reporting Documents will include the laboratory test results, procedures, interpretation and application for each project.

If you have questions regarding the testing protocol requirements, data storage, interpretation, reporting requirements or application do not hesitate to contact the Senior Geotechnical Engineer at (503-428-1344). All paper and electronic files from these laboratory tests are retained in projectwise. Approach Fill Design And Use Of Passive Pressure

### 17.1.2.5 Drilled Shaft Base Tip Grouting

Shaft base grouting is a relatively new shaft construction technique in the U.S. and reliable consistent methods of performance, and construction are not vetted with standardized designs, guidelines, and practices. Therefore, it is ODOT's standard not to use base-tip grouting on ODOT projects.

### 17.1.2.6 Downdrag Loads

If a downdrag condition exists, follow the neutral plane design procedure outlined in GEC-10 (Brown and Castelli, 2010). The load factors for downdrag loads provided in Table 3.4.1-2 of the AASHTO shall be used for the strength limit state. However, this table does not address the situation in which the soil contributing to downdrag in the strength limit state consists of sandy soil, the situation in which a significant portion of the soil profile consists of sandy layers, nor the situation in which the CPT is used to estimate downdrag loads and the pile bearing

resistance. Therefore, the portion of Table 3.4.1-2 in AASHTO that addresses downdrag loads has been augmented to address these situations as shown in Table 17-1).

**Table 17-1 Type of Load, Foundation Type, and Method Used to Calculate Downdrag**

Type of Load, Foundation Type, and Method Used to Calculate Downdrag		Load Factor	
		Maximum	Minimum
DD: Downdrag	Piles, $\alpha$ Tomlinson Method	1.4	0.25
	Piles, $\lambda$ Method	1.05	0.30
	Piles, Nordlund Method, or Nordlund and $\lambda$ Method	1.1	0.35
	Piles, CPT Method	1.1	0.40
	Drilled Shafts, O'Neill and Reese Method (WSDOT).	1.25	0.35

### 17.1.2.7 Timber Piles

Do not use timber piles.

### 17.1.2.8 Pre-stressed Concrete Piles

Do not use pre-stressed concrete piles.

## 17.1.3 Scour Design

Foundation design for the scour condition associated with the base flood (typ. 100-yr. event) is the same as the "no-scour" condition. Factored foundation resistances must be adequate to resist the factored loads associated with the strength and service limit states (AASHTO, Article 3.7.5). For the check flood condition the foundations must provide nominal bearing resistances (resistance factor equal to 1.0) sufficient to support the structure loads associated with the Extreme Limit State II (AASHTO, Article 10.5.5.3.2).

## 17.1.4 Traffic Structures

Various versions of the "AASHTO Standard Specifications for Structural Supports for Highway Signs, Luminaires, and Traffic Signals" are in effect and refer to "AASHTO Standard Specifications for Highway Bridges". The design approach used for the foundation design must be consistent with the design approach used for the structure. At this time monotube VMS, sign bridges, and signal poles use three different standards. The table below provides the current standard in effect, associated standard drawings, standard foundation drawings, and special provisions.

Table 17-2 Traffic Structures Standards

Structure Type	Standard	Design Method	Standard Drawings	Standard Foundation Drawings	Special Provision
Monotube VMS	2017, "AASHTO LRFD Specifications for Structural Supports for Highway Signs, Luminaires, and Traffic Signals."	LRFD	TM621 – TM628	TM627 and TM628	00921
Sign Bridges - Truss	1996, "AASHTO LRFD Specifications for Structural Supports for Highway Signs, Luminaires, and Traffic Signals."	ASD	TM606 – TM620	TM611/TM619	00920
Sign Bridges - Monotube	2017, "AASHTO LRFD Specifications for Structural Supports for Highway Signs, Luminaires, and Traffic Signals."	LRFD	TM627, TM628, TM693-TM697	TM627 and TM628	00921
Signal Poles SM1-SM5L	2003, "AASHTO LRFD Specifications for Structural Supports for Highway Signs, Luminaires, and Traffic Signals."	ASD	TM650 – TM653	TM653	00963
Signal Poles SM6L-SM7L	2017, "AASHTO LRFD Specifications for Structural Supports for Highway Signs, Luminaires, and Traffic Signals."	LRFD	TM655 – TM658	TM628	00921
Luminaires	1994, "AASHTO LRFD Specifications for Structural Supports for Highway Signs, Luminaires, and Traffic Signals."	ASD	TM630	TM630	00962
Camera Poles	2009, "AASHTO LRFD Specifications	LRFD	DET4640	N/A	SPS 00965

Structure Type	Standard	Design Method	Standard Drawings	Standard Foundation Drawings	Special Provision
	for Structural Supports for Highway Signs, Luminaires, and Traffic Signals.”				
High Mast Luminaires	2017, “AASHTO LRFD Standard Specifications for Bridge Design”	LRFD	N/A	N/A	00512 or 00921

### 17.1.4.1 Mast Arm Signal Poles

The Rutledge Method described in the AASHTO specifications is **not** an approved method for the design of signal pole drilled shaft foundations.

Mast arm signal pole foundations 60' and greater are designed to the most recent edition of *AASHTO LRFD Bridge Design Specifications*. [Section 17.9](#) of this chapter describes acceptable analysis methods to meet foundation design requirements.

### 17.1.5 End Bents

Historically a one-foot neat-line with drain material has been used. This detail allows for easy calculation of the excavation and drain material quantities. The detail does not provide limits for the backfill at the end bents and wing walls and while the specifications require granular structure backfill there is not consistent direction for the extent of the backfill. Thus, there are no assurances that the designed lateral earth pressures are achieved in construction.

For end bents, the lateral load of the bridge end fill must be considered in designing the end bent by both the Geotechnical Engineer and the Bridge Engineer. To more consistently model the behavior of the bridge and to ensure the design loads are constructed Standard Detail 3160 has been developed for use by the Geotechnical Engineer to provide relevant recommendations to the Bridge Engineer. The Geotechnical Engineer is responsible for providing the Bridge Engineer load diagrams and associated geotechnical notes.

Calculate and report active, at-rest, and passive lateral earth pressures in accordance with lateral earth pressure theory as provided in AASHTO 3.11.5.

Abutment type plays a large role in the Geotechnical Engineer's recommendations. Both active and passive lateral earth pressures requires movement/mobilization minimum amount is specified AASHTO Table C.3.11.1-1. Generally, abutments that will meet this requirement are integral, semi-integral, stub, and single-row pile caps. These abutment types are allowed and designed to move longitudinally. Therefore, active earth pressure is appropriate for design.

Stiff abutment walls, such as those required for spread footings, drilled shafts greater than 3-ft in diameter, and piles with multiple rows of piles will not move based on the required structural stiffness. In this case recommendations using at-rest lateral earth pressures are appropriate for design.

Bridge designers are allowed to use up to 70% of the passive earth pressure (Earthquake Restraining Systems and Earthquake Resisting Elements) as a method to dissipate energy during a seismic event if the horizontal seismic ground shaking can engage the passive pressure. It is the Geotechnical Engineer's responsibility to determine and provide the passive lateral earth pressure and provide the values, minimum mobilization criteria, and earth pressure diagram to the bridge engineer.

## 17.2 Foundation Selection Criteria

The foundation type selected for a given structure should result in the design of a buildable, economical foundation, taking into account any constructability issues and project constraints. The Geotechnical Memo and Geotechnical Report documents the suitability of each foundation type to meet the performance criteria as well as project constraints. The selection of the most suitable foundation for the structure is based on the following considerations:

- The ability of the foundation type to meet performance requirements (e.g., deformation, bearing resistance, uplift resistance, lateral resistance/deformation) for all limit states including scour and seismic conditions.
- The constructability of the foundation type (taking into account issues like traffic staging requirements, construction access, shoring required, cofferdams).
- The cost of the foundation and cost of seismic mitigation for the foundation.
- Meeting the requirements of environmental permits (e.g. in-water work periods, confinement requirements, noise or vibration effects from pile driving or other operations, hazardous materials).
- Constraints that may impact the foundation installation (e.g., overhead clearance, access, surface obstructions, and utilities).
- The construction and post-construction impacts of foundation construction on adjacent structures, or utilities,
- The impact of the foundation installation (in terms of time and space required) on traffic and right-of-way.

This is the most important step in the foundation design process. These considerations should be discussed with the structural designer and documented in the Geotechnical Memo and Report. Bridge bent locations may need to be adjusted based on the foundation conditions, construction access or other factors described above to arrive at the most economical and appropriate design.

### 17.2.1 Spread Footings

Spread footings are typically very cost effective, given the right set of conditions. Spread footings work best in hard or dense soils or rock where there is adequate bearing resistance and

provide tolerable settlement under load. Spread footings can get rather large depending on the structure loads and settlement requirements. Structures with tall columns or with high lateral loads which result in large eccentricities and spread footing uplift loads may not be suitable candidates for spread footing designs. Spread footings are not allowed where soil liquefaction can occur at or below the spread footing level. Other factors that affect the cost feasibility of spread footings include:

- The need for a cofferdam and seals when placed below the water table,
- The need for significant over-excavation and replacement of unsuitable soils,
- The need to place spread footings deep due to scour, liquefaction or other conditions,
- The need for significant shoring to protect adjacent existing facilities, and
- Inadequate overall stability when placed on slopes that have marginally adequate stability.

Settlement (service limit state criteria) often controls the feasibility of spread footings. The amount of spread footing settlement must be compatible with the overall bridge design. The superstructure type and span lengths usually dictate the amount of settlement the structure can tolerate and spread footings may still be feasible and cost effective if the structure can be designed to tolerate the estimated settlement (e.g., flat slab bridges, bridges with jackable abutments, etc.). Spread footings may not be feasible where expansive or collapsible soils are present near the bearing elevation. Refer to the FHWA Geotechnical Engineering Circular No. 6, *Shallow Foundations* (Kimmerling, 2002), and the FHWA publication, *Selection of Spread Footings on Soils to Support Highway Bridge Structures* (Samatini, 2010) for additional guidance on the selection and use of spread footings.

## 17.2.2 Deep Foundations

Deep foundations are the next choice when spread footings cannot be founded on competent soils or rock at a reasonable cost. Deep foundations are also required at locations where spread footings are unfeasible due to extensive scour depths, liquefaction or lateral spread problems. Deep foundations may be installed to depths below these susceptible soils to provide adequate foundation resistance and protection against these problems. Deep foundations should also be used where an unacceptable amount of spread footing settlement may occur. Deep foundations should be used where right-of-way, space limitations, or other constraints as discussed above would not allow the use of spread footings.

The two types of deep foundations most typically considered are: pile foundations, and drilled shaft foundations. The most economical deep foundation alternative should be selected unless there are other controlling factors. Shaft foundations are most advantageous where very dense intermediate strata must be penetrated to obtain the desired bearing, uplift, or lateral resistance, or where materials such as boulders or logs must be penetrated. Shafts are often cost effective where a single shaft per column can be used in lieu of a pile group with a pile cap, especially when a cofferdam, seal and/or shoring is required to construct the pile foundation and pile cap. Shafts are also sometimes used in lieu of piles where pile driving vibrations could cause damage to existing adjacent facilities or in situations where pile driving is restricted due to environmental regulations.

Shafts may not be desirable where contaminated soils are present, since the contaminated soil removed would require special handling and disposal. Constructability is also an important consideration in the selection of drilled shafts. For instance, artesian water pressure in subsurface soil layers could also preclude the use of drilled shafts due to the difficulty in maintaining stability of the shaft excavation.

When designing pile foundations keep in mind the potential cost impacts associated with the use of large pile hammers. Local pile driving contractors own hammers with rated energies typically ranging up to about 80,000 ft.-lbs. When larger hammers are required to drive piles to higher pile bearing resistance they have to rent the hammers and the mobilization cost associated with furnishing pile driving equipment may increase sharply. Larger hammers may also impact the design and cost work bridges due to higher hammer and crane loads.

For situations where existing substructures must be retrofitted to improve foundation resistance, where there is limited headroom available for pile driving or shaft construction, or where large amounts of boulders or obstructions must be penetrated, micropiles may be the best foundation alternative, and should be considered.

## 17.3 Seismic Design

[Chapter 7](#) describes ODOT seismic foundation design practices regarding design criteria, performance requirements, ground motion characterization, liquefaction analysis, ground deformation and mitigation. The most current edition of the "AASHTO Guide Specifications for LRFD Seismic Bridge Design", including the latest interims, should be used for seismic foundation design. Once the seismic analysis is performed the results are applied to foundation design in the Extreme Event I limit state analysis as described in Section 10 of the AASHTO. Also refer to, and be familiar with,

*Section 1.10.4; "Foundation Modeling", of the ODOT Bridge Design Manual.* This section describes the various methods bridge designers use to model the response of bridge foundations to seismic loading and also the geotechnical information required to perform the analysis.

If the foundation soils are determined to be susceptible to liquefaction, then spread footings should not be recommended for foundation support of the structure unless proven ground improvement techniques are employed to stabilize the foundation soils and eliminate the liquefaction potential. Otherwise, a deep foundation should be recommended.

Deep foundations (piles and drilled shafts) supporting structures that are constructed on potentially liquefiable soils are normally structurally checked for two separate loading conditions; i.e. with and without liquefaction. Nominal resistances, factored resistances (as appropriate), downdrag loads (if applicable) and soil (p-y) interaction parameters should be provided for both non-liquefied and liquefied foundation conditions. Communication with the structural designer is necessary to insure that the proper foundation design information is provided.

## 17.4 Spread Footing Design

Refer to AASHTO LRFD Bridge Design Specification, Article 10.6 for spread footing design requirements and supporting FHWA documents by Kimmerling (2002) and Gifford, et al. (1987).

Once footings are selected as the preferred design alternative, the general spread footing foundation design process can be summarized as follows. Close communication and interaction is required between the structural and geotechnical designers throughout the footing design phase.

- Determine footing elevation based on location of suitable bearing stratum and footing dimensions (taking into account any scour requirements, if applicable)
- Determine foundation material design parameters and groundwater conditions
- Calculate the nominal bearing resistance for various footing dimensions (consult with structural designer for suitable dimensions)
- Select resistance factors depending on design method(s) used; apply them to calculated nominal resistances to determine factored resistances
- Determine nominal bearing resistance at the service limit state
- Check overall stability (determine max. bearing load that maintains adequate slope stability)

For footings located in waterways, the bottom of the footing should be below the estimated depth of scour for the check flood (typically the 500 year flood event or the overtopping flood). The top of the footing should be below the depth of scour estimated for the design flood (either the overtopping or 100-year event). As a minimum, the bottom of all spread footings should also be at least 6 feet below the lowest streambed elevation unless they are keyed full depth into bedrock that is judged not to erode over the life of the structure. Spread footings are not permitted on soils that are predicted to liquefy under the design seismic event.

### 17.4.1 Nearby Structures

Refer to AASHTO, Article 10.6.1.8. Issues to be investigated include, but are not limit to, settlement of the existing structure due to the stress increase caused by the new footing, decreased overall stability due to the additional load created by the new footing, and the effect on the existing structure of excavation, shoring, and/or dewatering to construct the new foundation.

### 17.4.2 Service Limit State Design of Footings

Footing foundations shall be designed at the service limit state to meet the tolerable movements for the structure in accordance with AASHTO, Article 10.5.2. Consult with the bridge designer to obtain the maximum total and differential foundation settlements allowed for the proposed structure. The nominal unit bearing resistance at the service limit state shall be equal to or less than the maximum bearing stress that results in settlement that meets the tolerable movement criteria for the structure.



## 17.5 Driven Pile Foundation Design

Refer to AASHTO, Article 10.7 for pile design requirements. The FHWA publication “Design and Construction of Driven Pile Foundations” (Hannigan et al., 2016) may also be referenced for driven pile design guidance. Pile design should meet or exceed the requirements specified for each limit state.

The nominal bearing resistance of all driven piles shall be accepted based on either the FHWA Gates Equation, wave equation analysis, dynamic measurements with signal matching (PDA/CAPWAP) or full-scale load testing. Acceptance of driven piles shall not be accepted based solely on static analysis.

For piles requiring relatively low nominal resistances (<600 kips) and without concerns about high driving stresses, the FHWA Gates Equation is typically used for determining pile driving acceptance criteria. In cases where piles are driven to higher resistances or where high pile driving stresses are a concern, such as short, end bearing piles, the wave equation (GRLWEAP) is typically used for both drivability analysis and in determining the final driving acceptance criteria.

Pile acceptance based on the pile driving analyzer (PDA) is typically reserved for projects where it is economically advantageous to use, or for cases where high pile driving stresses are predicted and require monitoring. The PDA (with signal matching) method can be most cost effective on projects that have a large number of long, high capacity, friction piles.

Full-scale static pile load tests are less common in practice due to their inherent expense. However, they may be economically justified in cases where higher bearing resistances can be verified through load testing and applied in design to reduce the cost of the pile foundation. If static load testing is considered for a project it should be conducted early on in the design stage so the results may be utilized in the design of the structure. Also, the pile load test should be taken to complete failure if at all possible. Refer to AASHTO, Section 10 for descriptions on how to use the results of the static load tests results to determine driving criteria. Static load test results should be used in combination with either PDA/CAPWAP testing or wave equation analysis to develop final driving criteria for the production piles.

Once the pile (bent) locations and foundation materials and properties are defined, the pile foundation design process for normal bridge projects typically consists of the following:

- Determine scour depths (if applicable)
- Determine liquefaction potential and depths; estimate seismic induced settlement (if applicable)
- Evaluate long-term embankment settlement and downdrag potential
- Select most appropriate pile type
- Select pile dimension (size) based on discussions with structural designer regarding preliminary pile loading requirements (axial and lateral)
- Establish structural nominal resistance of the selected pile(s)

- Conduct static analysis to calculate nominal single pile resistance as a function of depth for the strength and extreme limit states (or a pile length for a specified resistance)
- Select resistance factors based on the field method to be used for pile acceptance (e.g. dynamic formula (FHWA Gates Equation), wave equation, PDA/CAPWAP, etc.)
- Calculate single pile factored resistance as a function of depth
- Estimate downdrag loads; consolidation and/or seismic-induced (if applicable)
- Calculate pile/pile group settlement or pile lengths required to preclude excessive settlement
- Determine nominal (and factored) uplift resistance as a function of depth
- Determine p-y curve parameters for lateral load analysis
- Modify parameters for liquefied soils (if applicable)
- Provide P-multipliers as appropriate for pile groups. P-multipliers are not required for pile groups installed in rock sockets where calculated lateral displacements are minimal (i.e., <0.50").
- Determine required pile tip elevation(s) based on structural and geotechnical design requirements including the effects of scour, downdrag, or liquefaction
- Obtain and verify final pile tip elevations and required resistances (to resist factored and unfactored loads) from the structural designer; finalize required pile tip elevations and assess the following:
  - Determine the need to perform a pile drivability analysis to obtain required tip elevation
  - Evaluate pile group settlement (if applicable). If settlement exceeds allowable criteria, adjust pile lengths or the size of the pile layout and/or lengths
- Determine the need for pile tip reinforcement

### 17.5.1 Required Pile Tip Elevation

Required pile tip elevations should typically be provided for all pile foundation design projects. The required pile tip elevation is provided to ensure the constructed foundation meets the design requirements of the project, which may include any or all of the following conditions and criteria:

- Pile tip reaches the designated bearing layer
- Scour
- Downdrag
- Uplift
- Lateral loads

A general note is included on the bridge plans designating the "Pile Tip Elevation for Minimum Penetration" for each bent.

The required tip elevation may require driving into, or through, very dense soil layers resulting in potentially high driving stresses. Under these conditions a wave equation drivability analysis is necessary to make sure the piles can be driven to the required embedment depth (tip elevation). Higher grade steel (ASTM A252, Grade 3 or A572, Grade 50) are sometimes specified

if needed to meet drivability criteria. If during the structural design process, adjustments in the required tip elevations are necessary, or if changes in the pile size or section are necessary, the geotechnical designer should be informed so that pile drivability can be re-evaluated.

## 17.5.2 Pile Drivability Analysis and Wave Equation Usage

High pile stresses often occur during pile driving operations and, depending on subsurface and loading conditions, a Wave Equation analysis should always be considered to evaluate driving stresses and the possibility of pile damage. A pile drivability analysis is typically used in most pile foundation designs to determine the nominal geotechnical resistance that a pile can be driven to without damage. Foundation piles should typically be driven to the highest geotechnical axial resistance feasible based on wave equation analysis so the maximum structural resistance of the pile is utilized, resulting in the most cost-effective pile design.

All piles driven to nominal resistances greater than 600 kips should be driven based on wave equation criteria. Piles driven to nominal resistance less than or equal to 600 kips may also require a wave equation analysis depending on the subsurface conditions (such as very short end bearing piles) and the pile loads. Engineering judgment is required in this determination. It is also advantageous to use the wave equation method to verify pile resistance because of the higher resistance factor (0.50) that can be used versus the FHWA Gates Equation factor of 0.40. Pile driving stresses should be limited to those described in AASHTO, Article 10.7.8.

## 17.5.3 Pile Setup and Restrike

Using a waiting period and restrike after initial pile driving may be advantageous in certain soil conditions to optimize pile foundation design. After initially driving the piles to a specified tip elevation, the piles are allowed to “set up” for a specified waiting period, which allows pore water pressures to dissipate and soil strength to increase. The piles are then re-struck to confirm the required nominal resistance.

The length of the waiting period depends primarily on the strength and drainage characteristics of the subsurface soils (how quickly the soil can drain) and the required nominal resistance. The minimum waiting period specified in the Standard Specifications is 24 hours. If needed, this waiting period may be extended in the contract special provisions to provide additional time for the soils to gain strength and the piles to gain resistance. However, consideration should be given to increased contractor standby costs that may be incurred by extended waiting periods. The pile design should compare the cost and risk of extending the standard waiting period to gain sufficient strength versus designing and driving the piles deeper to achieve the required bearing.

For projects with piles that require restrike, at least 2 piles per bent or 1 in 10 piles in a group (whichever is more) should typically be re-struck for pile acceptance. Additional restrike verification testing should be conducted on any piles that indicate lower resistance at the end of initial driving or if subsurface conditions vary substantially within a pile group. Restrike should

be performed using a warm pile hammer, which has been warmed up with at least 20 blows on another pile.

Restrike resistance (blows per inch) should be determined by measuring the total pile set in the first 5 blows of driving and in successive 5 blow increments thereafter up to a total of at least 20 blows or until refusal driving conditions are reached (>20 blows per inch). The driving resistance reported (in blows per inch) is then determined by taking the inverse of the set (inches/blow) per each 5 blow increment. The hammer stroke during the restrike should also be carefully measured and recorded since this is used in combination with the driving resistance (bpi) to determine the nominal pile resistance when using either the FHWA Gates formula or from wave equation criteria. For more sensitive soils (clays and some silts), it may be advantageous to use a pile driving analyzer for initial driving and restrike.

### 17.5.4 Driven Pile Types, and Sizes

The pile types generally used on most permanent structures are steel pipe piles (driven either open or closed-end) and steel H-piles. Either H-pile or open-end steel pipe pile can be used for end bearing conditions. For friction piles, steel pipe piles are often preferred because they can be driven closed-end (as full displacement piles) and because of their uniform cross section properties, which provides the same structural bending resistance in any direction of loading. This is especially helpful under seismic loading conditions where the actual direction of lateral loading is not precisely known. Uniform section properties of steel pipe piles also aid in pile driving. Closed-end steel pipe piles are typically not filled with concrete after driving.

Potential corrosion of steel piles must be taken into account during design according to AASHTO design procedures and as described in ODOT BDM Section 1.26.5.

Pipe piles are available in a variety of diameters and wall thickness; however there are some sizes that are much more common than others and therefore usually less expensive. The most common pipe pile sizes used on ODOT projects are:

- PP 16 x 0.5
- PP 18 x 0.5
- PP 20 x 0.5
- PP 24 x 0.5

The most common steel H-pile sizes used on ODOT projects are:

- HP10x42
- HP10x57
- HP 12x53
- HP 12x74
- HP 14x73
- HP 14x89
- HP 14x117

Do not use timber piles.

Do not use prestressed concrete piles.

The ASTM steel specifications and grades in the ODOT Standard Specifications are as follows:

- Steel Pipe Piles: ASTM A 252, Grade 2 or 3, or API 5L X42 or X52
- Steel H-piles: ASTM A 36

The higher grade steel such as ASTM A252 Grade 3 (for steel pipe piles) and A572 Grade 50 (for steel H-piles) are often specified for various reasons, including higher nominal resistances, high lateral bending stresses or less potential for pile damage during installation. These higher grades are also often available at a nominal cost over the cost of the standard steel grades.

Reinforced pile tips may be warranted in some cases where piles may encounter, or are required to penetrate through, very dense cobbles and/or boulders. Pile tips are useful in protecting the tip of the pile from damage. However, installing a reinforced pile tip does not eliminate all potential for pile damage. High driving stresses may occur at these locations and still result in pile damage located just above the reinforced pile tip. A drivability analysis should be performed in these cases where high tip resistance is anticipated. All reinforced tips are manufactured from high strength (A27) steel.

Tip reinforcement for H-piles are typically called pile points. These come in a variety of shapes and designs. H-pile tips are listed on the ODOT QPL. For pipe piles tip reinforcement are typically termed "shoes", although close-end "points", like conical points, are also available. Pipe pile shoes may be either inside or outside-fit. Besides protecting the pile tip, inside-fit shoes are sometimes specified to help in delaying the formation of a pile "plug" inside the pipe pile so the pile may penetrate further into, or even through, a relatively thin dense soil layer. If outside-fit shoes are specified, the outside lip of the shoe may affect (reduce) the pile skin friction and this effect should be taken into account in the pile design.

### **17.5.5 Extreme Event Limit State Design**

For the applicable factored loads for each extreme event limit state, the pile foundations shall be designed to have adequate factored axial and lateral resistance.

### **17.5.6 Scour Effects on Pile Design**

The effects of scour, where scour can occur, shall be evaluated in determining the required pile penetration depth. The pile foundation shall be designed so that the pile penetration after the design scour events satisfies the required nominal axial and lateral resistance. The pile foundation shall also be designed to resist debris loads occurring during the flood event in addition to the loads applied from the structure. At pile locations where scour is predicted, the nominal axial resistance of the material lost due to scour should be determined using a static analysis. The piles will need to be driven to the required nominal axial resistance plus this nominal skin friction resistance that will be lost due to scour.

**Equation 17-1**

$$\sum \eta \gamma_i Q_i \leq \phi R_n$$

The summation of the factored loads ( $\sum \gamma_i Q_i$ ) must be less than or equal to the factored resistance ( $\phi R_n$ ). Therefore, the nominal resistance needed,  $R_n$ , must be greater than or equal to the sum of the factored loads divided by the resistance factor  $\phi$ :

**Equation 17-2**

$$R_n \geq (\sum \gamma_i Q_i) / \phi_{\text{dyn}}$$

For scour conditions, the total pile resistance needs to account for the resistance in the scour zone that will not be available to contribute to the resistance required under the extreme event (scour) limit state. The total driving resistance,  $R_{\text{ndr}}$ , needed to obtain  $R_n$ , is therefore:

**Equation 17-3**

$$R_{\text{ndr}} = R_n + R_{\text{scour}}$$

Note that  $R_{\text{scour}}$  remains unfactored in this analysis to determine  $R_{\text{ndr}}$ .

Pile design for scour is illustrated further in [Figure 16.1](#), where,

$R_{\text{scour}}$  = skin friction which must be overcome during driving through scour zone (KIPS)

$Q_p = (\sum \gamma_i Q_i)$  = factored load per pile (KIPS)

$D_{\text{est}}$  = estimated pile length needed to obtain desired nominal resistance per pile (FT)

$\phi_{\text{dyn}}$  = resistance factor

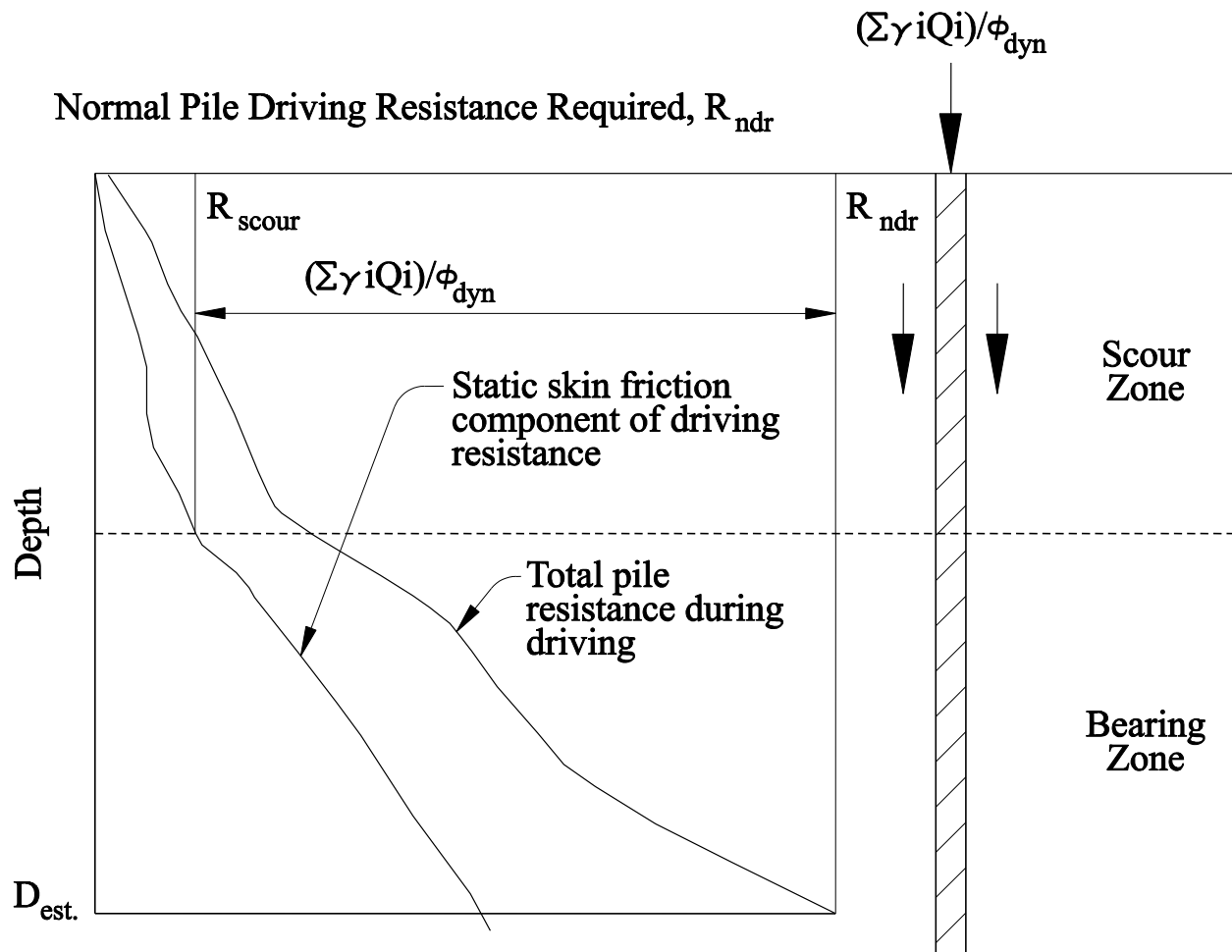

Figure 17-1 Design of pile foundations for scour

## 17.5.7 Seismic Design for Pile Foundations

For seismic design, all soil within and above liquefiable zones, shall not be considered to contribute axial compressive resistance. Downdrag resulting from liquefaction induced settlement shall be determined as specified in AASHTO and included in the loads applied to the foundation. Static downdrag loads should not be combined with seismic downdrag loads due to liquefaction.

The available factored geotechnical resistance should be greater than the factored loads applied to the pile, including the downdrag, at the extreme event limit state. The pile foundation shall be designed to structurally resist the downdrag plus structure loads. Pile design for liquefaction downdrag is illustrated in [Figure 17-2](#), where,

$R_{sdd}$  = skin friction which must be overcome during driving through downdrag zone

$Q_p$  =  $(\sum \gamma_i Q_i)$  = factored load per pile, excluding downdrag load

DD = downdrag load per pile

$D_{est.}$  = estimated pile length needed to obtain desired nominal resistance per pile

$\phi_{seis}$  = resistance factor for seismic conditions

$\gamma_p$  = load factor for downdrag

The nominal bearing resistance of the pile needed to resist the factored loads, including downdrag, is therefore,

Equation 17-4

$$R_n = (\sum \gamma_i Q_i) / \phi_{seis} + \gamma_p DD / \phi_{seis}$$

The total driving resistance,  $R_{ndr}$ , needed to obtain  $R_n$ , must account for the skin friction that has to be overcome during pile driving that does not contribute to the design resistance of the pile. Therefore:

Equation 17-5

$$R_{ndr} = R_n + R_{sdd}$$

Note that  $R_{sdd}$  remains unfactored in this analysis to determine  $R_{ndr}$ .

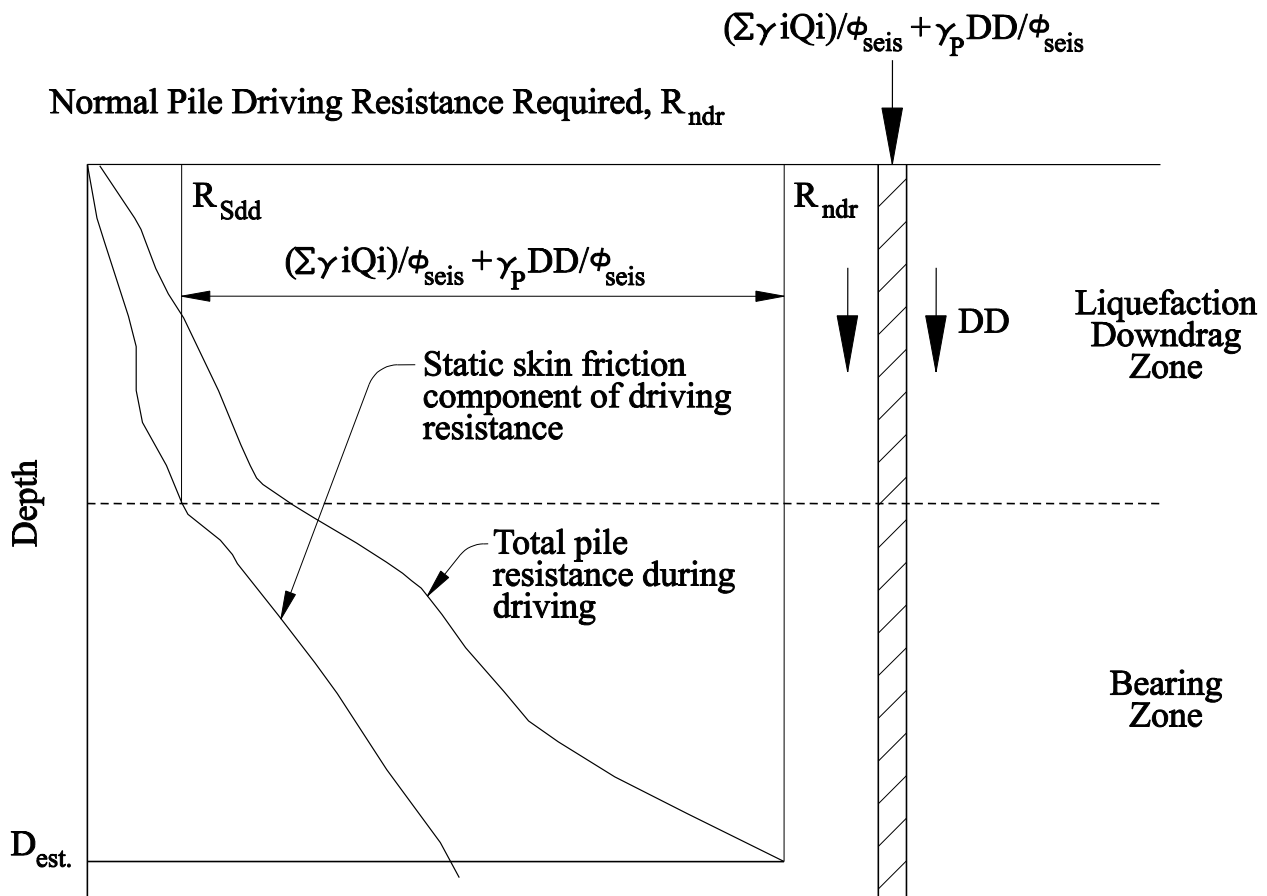

Figure 17-2 Design of pile foundations for liquefaction downdrag (WSDOT, 2006)



The static analysis procedures in the AASHTO should be used to estimate the skin friction within, above and below, the downdrag zone and to estimate pile lengths required to achieve the required bearing resistance. For this calculation, it should be assumed that the soil subject to downdrag still contributes overburden stress to the soil below the downdrag zone.

The pile foundation shall also be designed to resist the horizontal force resulting from lateral spreading, if applicable, or the liquefiable soil shall be improved to prevent liquefaction and lateral spreading. For lateral soil resistance of the pile foundation, the P-y curve soil parameters should be reduced to account for liquefaction. To determine the amount of reduction, the duration of strong shaking and the ability of the soil to fully develop a liquefied condition during the period of strong shaking should be considered.

The force resulting from flow failure/lateral spreading should be calculated as described in [Chapter 7](#). In general, the lateral spreading force should not be combined with the seismic forces. See [Chapter 7](#), "Seismic Design" for additional guidance regarding this issue.

## 17.6 Drilled Shaft Foundation Design

Refer to AASHTO, Article 10.8 for drilled shaft design requirements. Also reference the FHWA design manual "Drilled Shafts: Construction Procedures and LRFD Design Methods" (Brown, et al., 2010) for additional design guidance. Drilled shaft design should meet or exceed the requirements specified for each limit state provided by the bridge engineer.

Common shaft sizes range from 3 feet to 8 feet in diameter in 6 inch increments. Larger shaft diameters are also possible. Based on recent experience with the design and construction of drilled shafts any drilled shaft that may be design greater than 6' in diameter is required to be submitted no later than DDAP to State Foundation Engineer for review and concurrence. This provides time during project development to investigate, design, and incorporate appropriate level of quality control during construction.

Once the shaft locations and foundation materials and properties are known, the drilled shaft design process for normal bridge projects typically consists of the following:

- Determine scour depths (if applicable),
- Determine liquefaction potential and depths; estimate seismic induced settlement (if applicable),
- Evaluate long-term embankment settlement and downdrag potential,
- Select most appropriate shaft diameter(s) in consultation with structure designer,
- Determine (in consult with the structure designer) whether or not permanent casing will be used,
- Calculate nominal single shaft resistance as a function of depth,
- Select and apply resistance factors to nominal resistance,
- Estimate downdrag loads (if applicable),
- Estimate shaft or shaft group settlement and adjust shaft diameter or lengths if necessary to limit settlement to service state limits,

- Determine p-y curve parameters for lateral load analysis; modify parameters for liquefied soils (if applicable),

The diameter of shafts will usually be controlled by the superstructure design loads and the configuration of the structure but consideration should also be given to the foundation materials to be excavated. If boulders or large cobbles are anticipated, attempt to size the shafts large enough so the boulders or cobbles can be more easily removed if possible. Shaft diameters may also need to be increased to withstand seismic loading conditions. The geotechnical engineer and the bridge designer should confer and decide early on in the design process the most appropriate shaft diameter(s) to use for the bridge, given the loading conditions, subsurface conditions at the site and other factors. Also decide early on with the bridge designer if permanent casing is desired since this will affect both structural and geotechnical designs. Specify each shaft as either a “friction” or “end bearing” shaft since this dictates the final cleanout requirements in the specifications.

When the drilled shaft design calls for a specified length of shaft embedment into a bearing layer (rock socket) and the top of the bearing layer is not well defined, consideration should be given to adding an additional length of shaft reinforcement to the length required to reach the estimated tip elevation. This extra length is to account for the uncertainty and variability in the final shaft length. This practice is much preferred instead of having to splice on additional reinforcement in the field during which time the shaft excavation remains open. Any extra reinforcement length that is not needed can be easily cut off prior to steel placement once the final shaft tip elevation is known. CSL tubes would also need to be either cut off and recapped or otherwise adjusted. This additional reinforcement length should be determined by the geotechnical engineer based on an evaluation of the site geology, location of borehole information and the potential variability of the bearing layer surface at the plan location off the shaft. The additional recommended length should be provided in the Geotechnical Report and included in the project Special Provisions. Refer to the *Standard Special Provisions for Section 00512* for further guidance and details of this application. If a minimum rock embedment (socket) depth is required, specify the reason for the rock embedment.

Settlement may control the design of drilled shafts in cases where side resistance (friction) is minimal, loads are high and the shafts are primarily end bearing on compressible soil. The shaft settlement necessary to mobilize end bearing resistance may exceed that allowed by the bridge designer. Confer with the bridge designer to determine shaft service loads and allowable amounts of shaft settlement. Refer to the AASHTO methods to calculate the settlement of individual shafts or shaft groups. Compare this settlement to the maximum allowable settlement and modify the shaft design if necessary to reduce the estimated settlement to acceptable levels.

### **17.6.1 Drilled Shaft Base Grouting**

Drilled shaft base grouting (or post-grouting) is a process that generally involves pumping cement grout under pressure beneath the base of the shaft to increase the tip resistance. This technique is mostly effectively used for sandy soils with very little fines content. The grout is pumped through pipes into a grout-distribution system attached to the base of the drilled shaft

reinforcement. After the shaft is constructed and the concrete has gained adequate strength, grout is pumped through the grout system until grout is returned to the surface. The return valves are then closed and pressure is applied to the system to force grout out of tubes at the base of the shaft into the soil or to inflate a rubber membrane. Grout is pumped under pressure until a specified pressure criteria is achieved.

Shaft base grouting is a relatively new shaft construction technique in the U.S. and currently not addressed in AASHTO. As such, the use of shaft post grouting on ODOT projects must be approved with a design deviation prior to use.

## **17.6.2 Nearby Structures**

Where shaft foundations are placed adjacent to existing structures, the influence of the existing structure(s) on the behavior of the foundation, and the effect of the foundation on the existing structures, including vibration effects due to casing installation, should be investigated. In addition, the impact of caving soils during shaft excavation on the stability of foundations supporting adjacent structures should be evaluated. At locations where existing structure foundations are adjacent to the proposed shaft foundation, or where a shaft excavation cave-in could adversely affect an existing foundation, the design should require that casing be advanced as the shaft excavation proceeds.

## **17.6.3 Scour**

The effect of scour shall be considered in the determination of the shaft penetration. The shaft foundation shall be designed so that the shaft penetration and resistance remaining after the design scour events satisfies the required nominal axial and lateral resistance. For this calculation, it shall be assumed that the soil lost due to scour does not contribute to the overburden stress in the soil below the scour zone. The shaft foundation shall be designed to resist debris loads occurring during the flood event in addition to the loads applied from the structure.

Resistance factors for use with scour at the strength limit state are the same as those used without scour. The axial resistance of the material lost due to scour shall not be included in the shaft resistance.

## **17.6.4 Extreme Event Limit State Design of Drilled Shafts**

For downdrag due to liquefaction, the nominal shaft resistance available to support structure loads plus downdrag shall be estimated by considering only the positive skin and tip resistance below the lowest layer contributing to the downdrag. For this calculation, it shall be assumed that the soil contributing to downdrag does contribute to the overburden stress in the soil below the downdrag zone. The available factored geotechnical resistance should be greater than the factored loads applied to the shaft, including the downdrag loads, at the strength limit state. The shaft foundation shall be designed to structurally resist the downdrag plus structure loads.

## 17.7 Micropiles

Micropiles shall be designed in accordance with Article 10.9 of the *AASHTO*. Additional information on micropile design may be found in the FHWA Reference Manual; *Micropile Design and Construction*, Publication No. FHWA NHI-05-039 (Sabatini, et. al., 2005). While micropiles are great for resisting high axial loads lateral resistance is small and should be a consideration during design. Because of the low lateral resistance micropiles should not be used for new bridge construction with seismic or other lateral loads.

## 17.8 Traffic Structures

As Previously Stated, various versions of the “AASHTO Standard Specifications for Structural Supports for Highway Signs, Luminaires, and Traffic Signals” are in effect and refer to “AASHTO Standard Specifications for Highway Bridges”. The design approach used for the foundation design must be consistent with the design approach used for the structure. At this time monotube VMS, sign bridges, and signal poles use three different standards. The table below provides the current standard in effect, associated standard drawings, standard foundation drawing, and special provision.

**Table 17-3 Traffic Structures Standards**

Structure Type	Standard	Design Method	Standard Drawings	Standard Foundation Drawing	Special Provision
Monotube VMS	2017, “AASHTO LRFD Specifications for Structural Supports for Highway Signs, Luminaires, and Traffic Signals.”	LRFD	TM621 – TM628	TM627 and TM628	00921
Sign Bridges - Truss	1996, “AASHTO LRFD Specifications for Structural Supports for Highway Signs, Luminaires, and Traffic Signals.”	ASD	TM606 – TM620	TM611/TM619	00920
Sign Bridges - Monotube	2017, “AASHTO LRFD Specifications for Structural Supports for Highway Signs, Luminaires, and Traffic Signals.”	LRFD	TM627, TM628, TM693-TM697	TM627 and TM628	00921
Signal Poles SM1-SM5L	2003, “AASHTO LRFD Specifications for Structural Supports for Highway Signs,	ASD	TM650 – TM653	TM653	00963

Structure Type	Standard	Design Method	Standard Drawings	Standard Foundation Drawing	Special Provision
	<i>Luminaires, and Traffic Signals."</i>				
Signal Poles SM6L- SM7L	2017, "AASHTO LRFD Specifications for Structural Supports for Highway Signs, Luminaires, and Traffic Signals."	LRFD	TM655 – TM658	TM628	00921
Luminaires	2015, "AASHTO LRFD Specifications for Structural Supports for Highway Signs, Luminaires, and Traffic Signals."	LRFD	TM630	TM630	00962
High Mast Luminaires	2017, "AASHTO LRFD Standard Specifications for Bridge Design"	LRFD	N/A	N/A	00512 or 00921

## 16.9.1 Mast Arm Signal Pole Foundations

The standard drawings for Mast Arm Signal Poles are TM 650 through TM 658. These structures consist of a single vertical metal pole member of various heights and a horizontal signal (or mast) arm of various lengths. Lights, signals, and/or cameras will be suspended or supported from the mast arm. Currently there are two foundation design methodologies in place. Those less than 60' in length and those mast arm lengths 60' and greater. Regardless of size, the Rutledge Method described in the AASHTO specifications is **not** an approved method for the design of signal pole drilled shaft foundations.

### 17.8.1.1 Mast arm signal poles less than 60' in length

Standard drawings TM650-TM653 are used for the design of the foundations for these structures and are the most common signal pole foundations. The standard foundation lengths provided in Table 17-4 and Table 17-5 are for signal poles supported in cohesionless soil. These depths may be used when the conditions listed for each table can be met.

**Table 17-4 Minimum Lateral Embedment Depths for Standard Foundation of SM1 – SM5L Signal Poles in Cohesionless Soil when Groundwater is at Least 9 ft Below the Tip of the Foundation where  $\gamma = 100$  pcf and  $\phi = 26$  degrees and  $k = 25$  pci**

SM1 ft.	SM2 ft.	SM3 ft.	SM4 ft.	SM5 ft.	SM1L ft.	SM2L ft.	SM3L ft.	SM4L ft.	SM5L ft.
12	14	15	16	17	14	15	16	17	18

**Table 17-5 Minimum Lateral Embedment Depth for Standard Foundation of SM1 – SM5L Signal Poles in Cohesionless Soil and with groundwater at the ground surface where  $\gamma = 38$  pcf,  $\phi = 26$  degrees, and  $k = 20$  pci**

SM1 ft.	SM2 ft.	SM3 ft.	SM4 ft.	SM5 ft.	SM1L ft.	SM2L ft.	SM3L ft.	SM4L ft.	SM5L ft.
17	18	22	21	21	18	21	21	22	25

If any of the above assumptions cannot be met then complete a project specific design using L-Pile, as specified in AASHTO LRFD, to determine the length to fixity and the maximum lateral deflection of 0.50 inch is allowed at the top of the shaft (bottom of the cap). Factor of Safety to be used is 2.5 for side friction or a  $\phi = 0.40$ .

Resistance to torsion is not included in the design for signal pole foundations governed by standard drawings TM650-TM653. Mast arm signal poles are not designed for seismic loads, nor mitigated for liquefaction effects.

Report the foundation conditions at the signal pole site characterized in terms of soil type, soil unit weight, and soil friction angle or undrained shear strength and recommended foundation depth.

Where solid bedrock is confirmed to be within the depth of the shaft foundation, then the rock should be characterized in terms of its unconfined compressive strength ( $q_u$ ) and overall rock mass quality. In general, if the bedrock can be classified with a hardness of at least R1 (100 psi) and is unfractured or with tight, moderately close to very wide-spaced joints then a minimum shaft embedment depth of 5 feet can be used, as shown in Figure 17-.3, for mast arm pole types SM1-SM5L as specified on TM653.

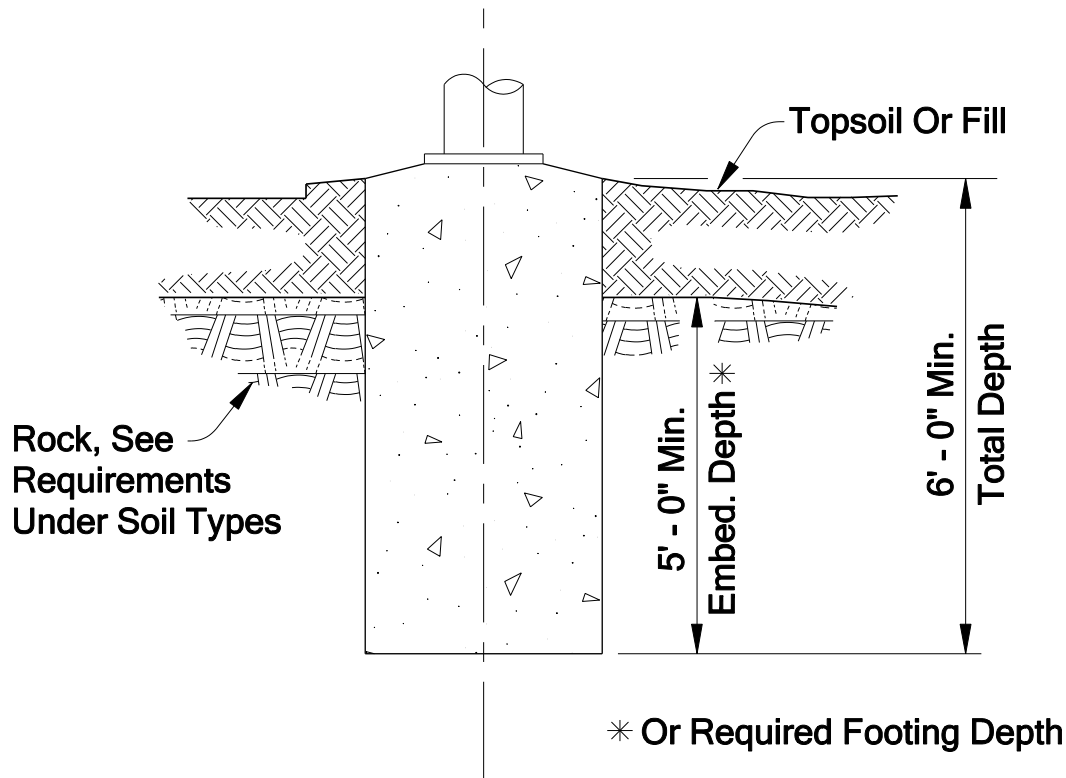

Figure 17-3 Rock Installation Requirements

If the rock is weaker than R1, moderately weathered or contains open fractures, then the properties of the rock mass should be more thoroughly investigated and a design should be performed based on the procedures previously specified in this chapter. For allowable stress design of drilled shafts in rock use a minimum factor of safety of 2.5 (for both side shear and end bearing) in determining allowable axial capacity. Use the soil-structure interaction (P-y) methods described in *AASHTO "LRFD Bridge Design Specifications,"* for lateral load analysis of drilled shafts in rock.

### 17.8.1.2 Mast arm signal poles 60' and greater than in length

Standard drawings TM655-TM658 are used for the design of the foundations for these structures and are not common signal pole foundations. Broms' Method and Rutledge are *not* an approved methods for the design of signal pole drilled shaft foundations with mast arms 60' and greater. Use LPile, as specified in AASHTO LRFD, to determine the length to fixity and the maximum lateral deflection of 0.50 inch at the top of the shaft (ground line).

Signal pole foundations governed by standard drawings TM655-TM658 are designed to resist torsion. Recent research studies have concluded and verified that existing methods produce acceptable results, for cohesionless and cohesive, soils (Hou, Kuang-Yuan, et al., 2019, Li et al.,

2017, Stuedlein, 2016). Methods vary from state-to-state ranging from only using shaft friction to performing finite element analysis for each design. In an effort to standardize, and use a common method the following narrative outlines the ODOT's procedures for calculating torsion. Whether cohesionless or cohesive soils AASHTO methods to calculate nominal shaft side resistance ( $R_s$ ) are used excluding the top five feet of the drilled shaft. Torsion resistance is comprised of friction along the shaft where the total resistance to torsion is:

$$R_{Tor} = R_s = r \sum_{L=5\ ft}^{L=tip\ of\ shaft} A_s q_s \quad (16-6)$$

Where  $R_{Tor}$  is the torsional resistance due to skin friction along the shaft and  $r$  is the radius of the drilled shaft.

Mast arm signal poles are not designed for seismic loads, nor mitigated for liquefaction effects. Report the foundation conditions at the signal pole site characterized in terms of soil type, soil unit weight, and soil friction angle or un-drained shear strength and recommended foundation depth.

## 17.8.2 Cantilever Sign Foundations

Cantilever signs consist of large metal posts supporting a cantilevered metal arm, which carries various types and sizes of signs and luminaires. Standard Drawings TM621 – TM628 cover the entire standard for this type of traffic structure. There are currently nine standard spread footing designs and three drilled shaft designs. Foundation design is based on the reactions at the base plate. There are two standard foundation drawings that can be used in VMS Monotube Cantilever Sign Design the spread footing shown TM627 or the drilled shaft TM 628.

The spread footing foundation is a rectangular spread footing, as shown on Drawing TM627. The dimensions of the spread footings range from 9' by 16' to 13.5' by 28'. All footings are 2'- 3" thick with a minimum 3'-0" of cover over the top of the footing. Footing dimensions are based on the Structure Design Numbers (1 – 9) and whether the footing is constructed on non-buoyant or buoyant soil conditions. Drawing TM627 contains soil properties, nominal bearing resistance, factored bearing resistance and resistance factors for each soil condition.

The difference between non-buoyant and buoyant soils is buoyant soils assume the groundwater table can rise up above the top of the footing and fully saturate the minimum 3 foot soil cover depth overlying the footing. If so, this reduces the effective unit weight of the overlying soils and the uplift resistance of the footing. The footing dimensions then have to be increased to compensate for this effect.

For spread footing recommendations, the Engineer of Record must report buoyant or non-buoyant condition, how the engineering soil properties are verified, minimum size spread footing which will meet the loading criteria with associated resistance factors.

Drilled shaft standard drawing is shown on TM628. Drilled shaft diameters range from 4.5' to 5' in diameter. As with the spread footing these are based on the Cantilever Structure Design Numbers 1-9. Broms' and Rutledge is **not** an approved methods for the geotechnical design of



monotube sign and cantilever VMS drilled shaft foundations. Use L-Pile, as specified in AASHTO LRFD, to determine the length to fixity and the maximum lateral deflection of 0.5 inch at the top of the shaft (ground line). Resistance to torsion is calculated for cantilever sign and VMS foundations governed by standard drawings TM628. Torsion resistance will be determined using ignoring the top 5 ft of the friction, following AASHTO friction resistance methods for cohesive and cohesionless soils and total torsion computed using equation 16-6. Cantilever sign/VMS drilled shaft foundations are not designed for seismic loads, nor mitigated for liquefaction effects.

Report the foundation conditions at the site characterized in terms of soil type, soil unit weight, and soil friction angle or un-drained shear strength, recommended foundation depth, controlling load (moment, torsion, lateral, axial) and whether this is a side-friction or end-bearing drilled shaft.

### 17.8.3 Sign And VMS Bridge Foundations

Currently there are two sets of standard sign/VMS bridges drawings. Standard drawings TM606-TM620 are for the truss style bridge. The second is the Monotube sign/vms bridge with standard drawings TM627, TM628 and TM693-TM697. Regardless of the style, the sign/vms bridge spans the roadway and lengths range from 50 feet to 167 feet.

Spread footings for sign/VMS bridges range in size from 12' by 24' to 20.5' by 41', depending on soil type (buoyant or non-buoyant) and truss span length. Minimum embedment over the top of the footing is 3'. All footings are 2.5' thick. Additional differential settlement criteria apply to these structures as noted on the drawings. Differential and uniform settlement should not exceed 2 inches. Footings are to be constructed on undisturbed soil or compacted granular structure backfill.

The difference between non-buoyant and buoyant soils is buoyant soils assume the groundwater table can rise up above the top of the footing and fully saturate the minimum 3 foot soil cover depth overlying the footing. If so, this reduces the effective unit weight of the overlying soils and the uplift resistance of the footing. The footing dimensions then have to be increased to compensate for this effect.

For spread footing recommendations, the Engineer of Record must report buoyant or non-buoyant condition, loading criteria, document how the engineering soil properties are verified, and recommended spread footing size.

### 17.8.4 Luminaire Supports

Standard luminaire poles consist of metal poles typically 30' to 70' high with a luminaire mast arm attached at the top. Standard foundations for luminaire supports are shaft foundations. Shafts may be either drilled shafts or constructed with concrete forms, backfilled, and compacted. These footings are either 30" or 36" in diameter or width and range from 6.5 feet to 9.0 feet in depth. The standard foundation design shown on Drawing TM631 is based on a soil parameter  $c = 600$  psf for cohesive soil and  $\phi = 25^\circ$  and  $\gamma = 100$  pcf and fully saturated.

If bedrock is expected to be encountered at shallow depths then a special design should be considered. If the bedrock is relatively hard, difficult to excavate or drill through, and would greatly impact the time required to construct the foundation excavation then develop a special foundation design, taking into account the higher foundation material strengths.

Report how the engineering soil properties for luminaires were verified and if bedrock is expected to be encountered.

### 17.8.5 High Mast Luminaire Support

High Mast Luminaire Supports are multi-arm illumination generally over 55 ft in height. Standard drawings do not exist for high mast illumination. If high mast illumination is required on a project, the foundations for these structures shall be drilled shafts. The foundation design and report should be developed based on site-specific soils investigation and a full soil-structure interaction analysis as described in this chapter for bridges. The traffic structures designer should be consulted for design loads and other design requirements.

### 17.8.6 Sound Walls

ODOT currently has three standard designs for sound walls which are designed in accordance with AASHTO Guide Specifications for Structural Design of Sound Barriers, 1989. The three standard sound wall designs are:

- Standard Reinforced Concrete Masonry Sound Wall; Drawing No. BR730
  - Foundation Type: Continuous Spread Footing
- Standard Precast Concrete Panel Sound Wall; Drawing No. BR740
  - Foundation Type: 3-ft- diameter drilled shafts
- Standard Masonry Sound Wall on Pile Footing; Drawings No. BR750 & BR751
  - Foundation Type: 2- to 3-ft-diameter drilled shafts

Standard foundation designs for these structures typically consist of spread footings (continuous or individual) or drilled shafts (with or without pilasters). These standard drawings are typically used at sites where the soil conditions are relatively uniform with depth. Lateral loads such as wind and seismic usually govern the foundation designs for these structures. The foundation designs provided on the Standard Drawings have been developed over many years, using a variety of foundation design methods.

Therefore, the foundation design method used for each of the standard drawings is discussed separately in the following sections.

#### Seismic Design

Sound walls are also designed for seismic loading conditions as described in the “AASHTO Guide Specifications for Structural Design of Sound Barriers.” No liquefaction analysis or mitigation of ground instability is required for sound walls.

### **Backfill Retention**

All Standard Drawings for sound wall structures have been designed to retain a minimal amount of soil that must be no more than 2 ft. in height with a level back slope. The retained soil above the sound wall foundation is assumed to have a friction angle of  $34^\circ$  and a wall interface friction of  $0.67\phi$ , resulting in a  $K_a$  of 0.26 for the retained soil, and a unit weight of 125 pcf. All standard and non-standard sound wall foundation designs shall include the effects of any differential fill height between the front and back of the wall.

## **17.8.6.1 BR730 Spread Footings**

Continuous spread footings are required for the Standard Reinforced Concrete Masonry Sound wall (Drawing No. BR730). The footing dimensions shown on this drawing are all based on the “Average” soil conditions even though a description of “Good” soil is provided. Sound wall footings shall be located relative to the final grade to have a minimum soil cover over the top of the footing of 1 ft.

### **Sloping Ground Conditions**

The standard foundation designs used for the Standard Plan sound walls are based on level ground conditions. Level ground conditions are defined as follows:

- **Good Soils:** 10H:1V max.
- **Average Soils:** 14H:1V max.

Sound walls are often constructed on sloping ground or near the edge of a steep break in slope. When the ground slope exceeds the above limits, the foundation design must be modified to account for slope effects. For the continuous spread footing design (BR730), a special design is necessary since there is no standardized method of modifying the standard footing widths or depths shown on the standard drawing.

Perform settlement calculations to confirm the required noise barrier height is maintained for the design life of the wall. The geotechnical designer will be responsible for estimating foundation settlement using the appropriate settlement theories and methods as outlined earlier in this chapter. The estimated total and differential settlement should be provided in the Geotechnical Report. In these cases, the total allowable settlement and differential settlement of the sound wall should follow retaining wall standards in AASHTO.

In addition to foundation design, an overall stability analysis of the sound wall should be performed when the wall is located on or at the crest of a cut or fill slope. The design slope model must include a surcharge load equal to the footing bearing stress. The minimum slope

stability factor of safety of the structure and slope shall be 1.5 or greater for static conditions and 1.1 for seismic conditions.

### 17.8.6.2 BR740, BR750 and BR751 Drilled Shafts

The footings for Drawings BR 740 and BR 750 (drilled shafts) are designed by Load Factor design. The footing (shaft) embedment lengths for these walls were design by the Rutledge Equation using  $S_1 = RL/3$ , where "S1" is the Allowable Ultimate Lateral Soil Capacity. "R" equals the Ultimate Lateral Soil capacity obtained by the log-spiral method increased by a 1.5 isolation factor and includes a 0.90 soil strength reduction factor.

All of the standard drawings for sound walls are based on the same set of foundation soil descriptions and designations. These are described as follows:

- **Good soil:** Compact, well graded sand or sand and gravel. Design  $\phi = 35^\circ$ , density 120 pcf, well drained and not located where water will stand.
- **Average soil:** Compact fine sand, well drained sandy loam, loose coarse sand and gravel, hard or medium clay. Design  $\phi = 25$ , density = 100 pcf. Soil should drain sufficiently so that water will not stand on the surface.
- **Poor soil:** (Soil investigation required) Soft clay, loams, poorly compacted sands. Contains large amounts of silt or organic material. Usually found in low lying areas that are subject to standing water.

For special designs, such as for "poor" soil conditions, buoyant conditions, or hard rock the geotechnical designer needs to provide the soil properties necessary to perform the foundation design. Foundation designs for these conditions should be performed using the Broms' method as described in "AASHTO Standard Specifications for Structural Supports for Highway Signs, Luminaires, and Traffic Signals".

For the standard drilled shaft foundations (BR740 and BR751), methods are shown on the drawings for adjusting the length of the shafts to account for slope effects. The maximum slope angle that shafts may be constructed on, using the standard drawings, are:

- **Good Soils:** 1½H:1V max.
- **Average Soils:** 2H:1V max.

For drilled shafts, the minimum horizontal setback distance is 3.0 ft. from the panel face to the slope break.

## 17.8.7 Buildings

Foundations shall be designed in accordance with the provisions outlined in the most recent version of the Oregon Structural Specialty Code (OSSC).

## 17.9 Construction Considerations

There are construction considerations for all foundation types. Each foundation type has construction considerations which must be in the plans, and special provisions. Construction considerations include but are not limited to access, construction platform and groundwater. Each of these elements will affect construction of spread footings, driven piles and drilled shafts differently. The discussion that follows provides insight for spread footing, driven pile and drilled shaft construction their access, platform, and groundwater consideration.

Regardless of foundation type the contractor needs to be able to gain access to the foundation location with equipment. Spread footings require large areas to be excavated frequently in rock and/or on steep slopes. Excavation equipment needs a safe approach and the ability to work below the slopes they are excavating, with overhead room and enough reach to perform the work. This may require work platforms, and/or shoring. Additionally, pile driving will require a crane for moving piles, and overhead room to drive piles. Like driven piles, drilled shafts need a crane to move rebar cages, casing as well as space for a concrete truck and most likely a concrete pump truck also. Access needs of the contractor need to be accounted for during project delivery.

Limited right-of-way or constrained access may lead to the need of a "construction platform". Construction platforms to provide access range from rock subgrade improvement to the use of temporary work access structures. Regardless of the type, construction platforms need to be considered and provided in the plans, specifications and cost estimates.

Other construction consideration, if not accounted for, that can become expensive in construction is groundwater control. Dewatering of excavations provide for safety and allow for a construction of spread footing. While deep foundations (driven piles and drilled shafts) do not typically need the excavation of a spread footing they do need to connect/integrate with abutments which can be quite tall and have been known to intercept the groundwater table. Groundwater issues need to be identified early in the project, included in project plans, specs and estimates to avoid claims and contract change orders.

Structures that require short round or square foundations could be easily formed in an open excavation. Following the removal of the concrete forms, backfill should be placed and compacted around the footing to provide containment and lateral support. Footings constructed using forms and backfill should be backfilled using Granular Structure backfill material compacted to the requirements specified in Section 00510 of the *ODOT Standard Specifications*. The geotechnical designer should make sure the contract specifications clearly state the backfill and compaction requirements for the backfill material placed around the formed foundation and that the degree of compaction is verified in the field.

Shaft foundations may require the use of temporary casing, drilling slurries or both. **Most shaft foundations are designed with the concrete in direct contact with the** soil. Special foundation designs may require the use of permanent casing if recommended by the geotechnical designer, in which case, the concrete will not be in direct contact with the soils.

An example of this is where the foundation soils may be too soft and weak to allow for the removal of temporary casing. In this situation, the structural designer must be informed of this condition. The use of permanent casing alters the stiffness and strength of the shaft as well as the soil-shaft friction and torsional shaft capacity.

The presence of a high groundwater table could affect the construction of shaft foundations. Shaft foundations are especially vulnerable to caving if groundwater is encountered and there are loose clean sands or gravels present.

## 17.10 References

- AASHTO, 2010, [AASHTO Guide Specifications for Structural Design of Sound Barriers](#).
- AASHTO, 2002, "AASHTO Standard Specifications for Structural Supports for Highway Signs, Luminaires, and Traffic Signals."
- AASHTO, 2003, "AASHTO Standard Specifications for Structural Supports for Highway Signs, Luminaires, and Traffic Signals."
- AASHTO, 2017, "AASHTO LRFD Specifications for Structural Supports for Highway Signs, Luminaires, and Traffic Signals."
- AASHTO, 2002, "Standard Specifications for Highway Bridges," American Association of State Highway and Transportation Officials, Seventeenth Edition, Washington, D.C., USA, p. 686.
- AASHTO, "LRFD Bridge Design Specifications", American Association of State Highway and Transportation Officials, most current edition, Washington, D.C., USA.
- AASHTO, 2010, "Standard of Practice for Assessment of Corrosion of Steel Piling for Non-Marine Applications", AASHTO Report R 27-01 (2010), American Association of State Highway and Transportation Officials, Washington, D.C.
- AASHTO, 2011. "AASHTO Guide Specifications for LRFD Seismic Bridge Design", 2nd Edition and Interim Revisions, American Association of State Highway and Transportation Officials, Washington, D.C.
- AASHTO, 2017, "[LRFD Bridge Design Specifications](#)", American Association of State Highway and Transportation Officials, Eighth Edition, Washington, D.C. (Note: most current edition shall be used).
- Adama Engineering, Inc., 2003, "Foundation Stress and Settlement Analysis Program (FoSSA)", Newark, N.J., <http://www.geoprograms.com/>
- Arneson, L.A., Zevenbergen, L. W., Lagasse, P.F., Clopper, P.E., 2012. "[Evaluating Scour at Bridges](#)", FHWA-HIF-12-003 HEC-18, 5<sup>th</sup> Edition, Federal Highway Administration, Washington, D.C.
- Beavers, J.A. and Durr, C.L., 1998, "[Corrosion of Steel Piling in Non-Marine Applications](#)", NCHRP Project 10-46, Report 408, National Cooperative Highway Research Program, Transportation Research Board, Washington, D.C
- Bowles, J., 1988. [Foundation Analysis and Design](#). 4<sup>th</sup> Edition, McGraw-Hill Book Company.

- Briaud, J., and Tucker, L., 1997. "Design and Construction Guidelines for Downdrag on Uncoated and Bitumen-Coated Piles", NCHRP Report 393, Transportation Research Board, National Research Council, Washington, D.C.
- Brown, D.A., Turner, J.P., Castelli, R. J., 2010. "Geotechnical Engineering Circular No. 10, Drilled Shafts: Construction Procedures and LRFD Design Methods", Report No.FHWA-NHI-10-016, Federal Highway Administration, Washington, D.C.
- Elias, V., Christopher, B.R., and Berg, R.R., 2001, "[Mechanically Stabilized Earth Walls and Reinforced Soil Slopes, Design and Construction Guidelines](#)", Federal Highway Administration, FHWA-NHI-00-043.
- Gifford, D. G., J. R. Kraemer, J. R. Wheeler, and A. F. McKown. 1987. "Spread Footings for Highway Bridges." FHWA/RD-86/185. Federal Highway Administration, U.S. Department of Transportation, Washington, DC, p. 229.
- Hannigan, P.J., Rausche, F., Likins, G.E., Robinson, B.R. and Becker, M.L., 2016. "Design and Construction of Driven Pile Foundations, Vol 1 & Vol 2", FHWA-NHI-16-009 and FHWA-NHI-16-010, Federal Highway Administration, Washington, D.C.
- Kavazanjian, E., Jr., Wang, J-N., Martin, G.R., Shamsabadi, A., Lam, I.P., Dickenson, S.E., and Hung, C.J., 2011. "Geotechnical Engineering Circular No. 3, LRFD Seismic Analysis and Design of Transportation Geotechnical Features and Structural Foundations", Report No. FHWA-NHI-11-032, Federal Highway Administration, Washington, D.C.
- Kimmerling, R. E. 2002. "<https://www.fhwa.dot.gov/engineering/geotech/pubs/010943.pdf>", Report No. FHWA-SA-02-054, Federal Highway Administration, Washington, D.C.
- Moulton, L. K., H. V. S. GangaRao, and G. T. Halverson. 1985. "[Tolerable Movement Criteria for Highway Bridges](#)", FHWA/RD-85/107. Federal Highway Administration, U.S. Department of Transportation, Washington, DC, p. 118.
- Oregon Department of Transportation, [Bridge Design Manual](#), Bridge Engineering Section.
- Oregon Department of Transportation, [Hydraulics Manual](#), Geo-Environmental Section.
- Oregon Department of Transportation, [Soil and Rock Classification Manual](#), Geotechnical Engineering and Engineering Geology Section, 1987.
- Oregon Department of Transportation, "[Standard Specifications for Highway Construction](#)", 2018 Edition and related Standard Special Provisions.
- Reese, L. C. 1984. "Handbook on Design of Piles and Drilled Shafts Under Lateral Load". FHWA-IP-84/11, Federal Highway Administration, U.S. Department of Transportation, Washington, DC.
- Reese, L. C., 1986. "Behavior of Piles and Pile Groups Under Lateral Load", Report No. FHWA/RD-85/106, U. S. Department of Transportation, Federal Highway Administration, Office of Engineering and Highway Operations Research and Development, Washington D. C., 311
- Sabatini, P.J., Bachus, R.C., Mayne, P.W., Schneider, J.A., and Zettler, T.E., 2002, *Geotechnical Engineering Circular No. 5, [Geotechnical Engineering Circular No. 5, Evaluation of Soil and Rock Properties](#)*, U.S. Department of Transportation, Federal Highway Administration, Washington, D.C.
- Sabatini, P.J., Tanyu, B., Armour, T., Groneck, P., Keeley, J., 2005. "Micropile Design and Construction" (Reference Manual for NHI Course 132078), Federal Highway Administration Report No. FHWA NHI-05-039, Washington, D.C.

- Samtani, N.C., Nowatzki, E.A., Mertz, D.R., 2010. “*Selection of Spread Footings on Soil to Support Highway Bridge Structures*”, Federal Highway Administration Report No. FHWA-RC/TD-10-001, Washington, D.C.
- Samtani, N. C. and Nowatzki, E., 2006. “*Soils and Foundations Reference Manual, Volumes I and II*”, FHWA-NHI-06-088 and FHWA-NHI-06-089, Federal Highway Administration, Washington, D.C.
- Washington State Department of Transportation, 2013, <https://www.wsdot.wa.gov/Publications/Manuals/M46-03.htm>.
- Kimmerling, R. E. 2002. “ <https://www.fhwa.dot.gov/engineering/geotech/pubs/010943.pdf> ”, Report
- Washington State Department of Transportation, 2013, <https://www.wsdot.wa.gov/Publications/Manuals/M46-03.htm>.
- Ivey, D. L. and L. Hawkins, “*Signboard Footings to Resist Wind Loads*,” *Civil Engineering*, December 1966.
- Oregon Department of Transportation, *ODOT Traffic Structures Design Manual, Roadway Traffic Section*, 2021.
- Patterson, D., 1962, “*How to Design Pole-Type Buildings*,” American Wood Preservers Institute, Chicago, Third Edition.

Peck, R. B., W. E. Hanson, and T. H. Thornburn, 1974. “*Foundation Engineering*,” Second Edition, John Wiley and Sons, Inc., New York, NY, p. 514



# **Chapter 18 - Culverts and Trenchless Technology Design**



## **Chapter Contents**

<b>Chapter 18 - Culverts and Trenchless Technology Design .....</b>	<b>18-1</b>
18.1 General.....	18-3
18.2 Culverts .....	18-3
18.2.1 Geotechnical Requirements for Culverts .....	18-3
18.2.2 Wing Walls .....	18-4
18.3 Trenchless Utility Installation .....	18-4
18.3.1 Pipe Jacking.....	18-5
18.3.2 Horizontal Auger Boring .....	18-5
18.3.3 Pipe Ramming .....	18-6
18.3.4 Microtunneling.....	18-6
18.3.5 Horizontal Directional Drilling.....	18-6
18.3.6 Pipe Bursting.....	18-7
18.3.7 Utility Tunneling.....	18-9
18.3.8 Geotechnical Explorations for Trenchless Methods.....	18-9

**List Of Tables**

---

Table 18-1 IPBA Pipe Bursting Classification System..... 18-8  
Table 18-2 NCHRP, Synthesis of Highway Practice 242, Trenchless Installation of Conduits  
Beneath Roadways ..... 18-10

## 18.1 General

Culverts, stormwater piping, and other utility pipelines are installed within the highway right of way by ODOT and by other agencies and entities. Culvert design requires multidisciplinary coordination in the design process including culvert and roadway alignment design, survey and geotechnical data acquisition, hydrologic and hydraulic analysis, structure and foundation design, scour evaluation and countermeasures, environmental compliance, staging, shoring requirements and constructability. This section covers the geotechnical aspects of culvert design and construction using open excavation as well as a summary of trenchless utility installation techniques.

## 18.2 Culverts

The ODOT BDM classifies culverts with a single span or out-to-out sum of closely spaced spans of 20 feet or greater as bridges; culverts with a diameter or span greater than 6 feet are classified as large culverts. Refer to the ODOT BDM for additional requirements for large culverts and bridges. Foundation design for culverts, including large and bridge size culverts falls within the scope of AASHTO LRFD Bridge Design Manual Section 12 Buried Structures and Tunnel Liners.

ODOT BR800 series standard drawings contain design details for single and double cell box culverts applicable to the soil properties stated in the drawings. The geotechnical engineer is responsible for verifying design soil property assumptions stated on the standard drawing are applicable to the project specific site, or require project specific design is needed.

Standard Specifications Section 00595 includes construction specifications for cast-in-place reinforced concrete box culverts, precast reinforced concrete box culverts, precast segmental reinforced concrete box culverts, and precast reinforced concrete three-sided structures. This specification requires stamped design calculations and stamped working drawings for precast culvert types under the construction contract.

### 18.2.1 Geotechnical Requirements for Culverts

Exploration requirements for culvert projects are addressed in [Section 4.5.2.5](#).

As a minimum, the geotechnical recommendations for culvert projects should address the following:

- Soil conditions, including pH, resistivity, gradation, and general classification anticipated below, adjacent to, and above the proposed culvert for a distance of 3 pipe diameters around the culvert and below the outfall.
- Foundation and retained soil properties for design.
- Depth and nature of bedrock or boulders, if encountered.
- An estimate of soil strength and stiffness.

- The potential for groundwater within the depth of installation, including any potential impacts on bedding. Text to address the likelihood of construction dewatering being needed and, if applicable, dewatering recommendations.
- Anticipated total and differential pipe settlement resulting from embankment fill and/or backfill.
- Recommendations to mitigate settlements where excessive settlement is predicted.
- Suitability of excavated soil for re-use as backfill.
- Recommended excavation and temporary shoring if determined necessary.

Structural design of culverts shall be based on AASHTO LRFD methods with soil loads and design procedures as specified in Sections 3 and 12 of the AASHTO LRFD Bridge Design Specifications.

### **18.2.2 Wing Walls**

The design of wing walls is a frequently overlooked aspect of culvert installation and repair projects. In general, any wing wall not directly connected to, and structurally supported by, the culvert pipe is considered a retaining wall and should be investigated and designed in accordance with [Chapter 16](#) of the GDM.

## **18.3 Trenchless Utility Installation**

Trenchless installation methods allow for the installation of utility conduits without breaking the ground surface above the pipe. Such methods are frequently more technically difficult and, on first examination, may appear to be more expensive than open cut, trenched, methods. However, they represent the most viable and cost effective approach for crossings under many existing roads, railroads, and rivers. Other reasons for trenchless methods to be considered include work adjacent to settlement sensitive structures or avoidance of hazardous materials.

The cost of trenchless can seem higher with respect to conventional open cut methods unless all costs of open cut work are considered. One such cost would be the potential for future maintenance associated with cutting and patching the pavement. Other costs include pavement and trench spoil transportation and disposal, backfill, traffic control, labor, detours, relocation of utilities, social \ economic costs, and environmental costs.

The principal techniques utilized in transportation projects include the following:

- Pipe Jacking
- Horizontal Auger Boring
- Pipe Ramming
- Microtunneling
- Horizontal Directional Drilling
- Pipe Bursting
- Utility Tunneling

Each method listed above is described in more detail below.

### **18.3.1 Pipe Jacking**

Aside from open cut installation, pipe jacking is the most common technique used to replace failed, failing, or undersized culverts. In general, pipe jacking consists of using hydraulic jacks to push pipes through the ground. The forward element of the pipe typically consists of a slightly oversized tunnel shield that minimizes pipe damage and side friction. For culvert replacement, the technique involves jacking a new pipe into place around the existing culvert and then subsequently removing the original culvert and residual soil.

The pipe jacking procedure uses the thrust power of the hydraulic jacks to force the pipe forward through the ground as the pipe jacking face is excavated. The spoils are transported through the inside of the pipe to the drive shaft, where it is removed. After each pipe segment has been installed, the rams of the jacks are retracted so that another pipe segment can be placed in position for the jacking cycle to begin again. Excavation is accomplished by hand mining or mechanical excavation within a shield or by a micro-tunnel boring machine (MTBM).

The selection of excavation method is based on a careful assessment of subsurface conditions in the installation zone for the presence of bedrock, boulders, cobbles, and fill obstructions such as stumps or logs as well as instability. Many methods are difficult to infeasible in areas where bedrock, cemented soils, or large particles (boulders and cobbles) are present. If there is any possibility of excavation face collapse, soil stabilization techniques must be considered. Common soil stabilization techniques are dewatering and grouting. Important optional equipment available for the pipe jacking method includes a pipe lubrication system and intermediate jacking stations. The pipe lubrication system consists of mixing and pumping equipment necessary for applying bentonite or polymer slurry to the external surface of the pipe. An adequate lubrication system can decrease jacking forces by 20 to 30 percent.

**Backstop Design.** The backstop is a rigid plate placed between the jack and the back wall of the jacking pit that is used to distribute the jacking load into the ground. The load required to push the pipe through the ground depends on the method and lubricants used and equipment capacity. The backstop is typically constructed normal (square) to the proposed pipe casing alignment. The sizing of the backstop can be based upon a passive soil pressure of 400 pounds per square foot (psf). The backstop or jacking wall should be Contractor-designed and should support the maximum obtainable jacking pressure with a safety factor of at least 2.0.

### **18.3.2 Horizontal Auger Boring**

Auger boring is similar to pipe jacking except that a rotary cutting head is used to form the bore hole as the pipe is jacked, significantly reducing the necessary jacking forces. Spoils are removed from the pipe by a rotating auger. In general, auger boring allows for little to no steering. The stress and impact associated with an auger working within the casing generally limits the material choice to steel. Frequently a steel exterior casing is lined with a smaller carrier pipe of different materials.

Auger boring should generally not be used when the presence of cobbles and boulders larger than one third of the casing diameter is possible. This method can also be difficult in loose

granular soils below the groundwater table. Bores in rock are feasible but are generally limited to weaker rock.

### **18.3.3 Pipe Ramming**

Pipe ramming uses a pneumatic hammer to drive a steel casing. The casing itself generally constitutes the drilling tool. Cuttings are removed using an auger or with compressed air or water. In some situations, small-diameter pipes can be driven with a closed end, negating the need for cuttings removal. Pipe ramming is most successful in stable, cohesive soils. With unstable soil conditions, the potential for voids and settlements are large. The method is generally not feasible within gravels and cobbles unless the casing diameter is large relative to the largest anticipated soil particle size.

### **18.3.4 Microtunneling**

Microtunneling is a trenchless construction method for installing conduits in a wide range of soil conditions, while maintaining close tolerances to line and grade from the drive shaft to the reception shaft. The microtunneling process is a cyclic pipe jacking process. For the soil types present (generally silts and clays with shallow groundwater), microtunneling methods can include slurry tunneling or earth pressure balance (EPB).

In the slurry type method, slurry is pumped to the face of the MTBM. Excavated materials mixed with slurry are transported to the driving shaft and discharged at the soil separation unit above the ground. EPB is a mechanized tunneling method in which spoil is admitted into the tunnel boring machine (TBM) via a screw conveyor (cochlea) arrangement which allows the pressure at the face of the TBM to remain balanced without the use of slurry.

Microtunneling can be applied to a wide range of soil types. The most favorable ground condition for slurry microtunneling is wet sand.

### **18.3.5 Horizontal Directional Drilling**

HDD is a trenchless method of installing underground pipes using a specialized drill rig. Typically, a pilot hole is drilled and then subsequently enlarged using a tool known as a back-reamer. Finally, the pipe or casing is pulled into the enlarged shaft. The drilling is typically accomplished using a drilling slurry of water and bentonite or polymer. HDD can be applied to a wide range of soil types.

The primary geotechnical issue that complicates HDD installation is the leaking of drilling fluids to the ground surface (referred to as hydro fracture or frac out). Significant differences in density and stiffness between two formations will result in a tendency for the drill string to wander.

If encountered, cobbles and boulders present issues with respect to steering, borehole advancement, and borehole stability. Perhaps more challenging in such soils is the inability to maintain drilling fluids within the borehole. The loss (and necessary replacement) of drilling

fluids directly results in expense and delay. Additionally, failure to maintain pressures can result in borehole collapse.

A known difficulty in drilling in formations containing cobbles is to avoid freeing up cobbles that then drop into the bore path. Cobble formations are easily disturbed. Aggressive pressure on the drill string can result in damaging the soil structure that is present. This typically results in freeing up cobbles and gravels that might otherwise stay in place. In addition to moderating drill string forces, borehole support through increased gel strength of the drilling fluid is crucial. Enhanced gel strength would involve a higher concentration of bentonite and likely a polymer additive designed for gel strength enhancement.

Another significant issue with gravels and cobbles is that of removing the cuttings from the bore path. Removing whole cobbles and smaller pieces created through mechanically breaking-up the cobbles with the bit or reamer can be difficult.

All projects that involve HDD should include the development of a geotechnical report based on project-specific subsurface explorations and laboratory testing. The geotechnical report should include a description of the geotechnical feasibility of completing the proposed project using HDD techniques. The report should summarize the explorations and laboratory data as well as present an overall conceptual model of the materials anticipated to be encountered during drilling. Specific items to be addressed include:

- A cross section of the soils anticipated to be present across the proposed bore;
- Anticipated groundwater conditions, including the potential for confined or artesian conditions;
- The presence of coarse granular soils; and
- Bedrock strengths.

Geotechnical data presented for HDD projects includes the nature and distribution of material anticipated to be encountered during installation. For each formation, the Professional of Record (POR) should provide the Friction Angle, Cohesion Intercept, Unit Weight, and Shear Modulus.

### **18.3.6 Pipe Bursting**

Pipe bursting consists of breaking up the existing pipe, pushing aside the fractured pipe pieces, and pulling or jacking a new pipe in place. Subject to site conditions, the method can be used to maintain the existing pipe size or to install a new pipe size up to 100 percent larger than the original pipe diameter.

The soil conditions most conducive to pipe bursting are those that allow for the deflection of the burst pipe segments through compaction or consolidation of the soils. Stiff soils can result in significant surface heave or impacts to adjacent utilities. Cohesive soils can be preferable in that they will maintain the open hole formed by the pipe-bursting while the new pipe is being pulled into place; this limits the friction on the new pipe and reduces tensile stresses. As such, the most favorable soils would be soft clays, preferably above the groundwater table.

Pipe bursting below the groundwater table can be quite difficult. The pipe-bursting process can increase pore water pressures, reducing effective stresses; this can result in a “quick” condition where soil strengths are seriously reduced and the soil behaves as a fluid. The result is that pipe buoyancy forces are increased and soils in the pipe zone can flow into the pipe and into the receiving pit. It may be necessary to dewater for pipe-bursting processes.

The International Pipe Bursting Association (IPBA) classifies pipe bursting installations into three categories based on the depth of the existing pipe, existing and new pipe diameters, and burst length (IPBA, 2004). The IPBA Pipe Bursting Classification System is presented in the table below.

**Table 18-1 IPBA Pipe Bursting Classification System**

IPBA Classification of Difficulty	Depth of Pipe (feet)	Existing Pipe ID (inches)	New Pipe Diameter Compared to Existing Pipe	Burst Length (feet)
A - Minimal	<12	2-12	Size on Size	0-350
B - Moderate	>12 to <18	12-18	Single Upsize	350-500
C - Comprehensive	>18	20-36	Double/Triple Upsize	200-1,000

Pipe-Bursting Equipment. The contractor's choice of pipe replacement method and equipment should be compatible with the project requirements and subsurface conditions. It is particularly crucial that the Contractor select equipment that it capable of completing the proposed burst lengths given the subsurface conditions, depth, and upsize. Although specialty techniques exist to burst nearly any type of pipe, conventional pipe bursting is generally only applicable to existing vitrified clay, asbestos cement, unreinforced concrete, and PVC pipes. More complex methods exist for bursting some reinforced concrete pipes. Corrugated metal pipe is typically difficult to burst.

Lubricant. A primary component of the installation load applied to pipelines installed using pipe bursting methods is the friction generated between the new pipe and the burst pipe/soil matrix as the new pipe is pulled into place. In many cases, friction (and, therefore, the installation load) on the installed pipe can be reduced through the use of pipe lubricants.

According to the IPBA (2004), the use of lubricants should be considered when:

- The new pipe diameter is equal to or greater than 2 times the existing pipe diameter;
- The burst length exceeds 300 feet;
- The new pipe diameter exceeds 12 inches;
- The host pipe is below groundwater;
- The ground conditions are unstable (i.e., flowing ground); and
- Recommended by the bursting equipment manufacturer.



Resistance Forces. Passive pressures against native or embankment soils are likely to be used to develop forces necessary to accomplish the pipe bursting. Allowable resistance forces with estimated deflections would typically be included in the geotechnical recommendations prepared for the project.

### **18.3.7 Utility Tunneling**

Utility tunneling is a method of soil excavation similar to pipe jacking. The difference is in the lining used. In Pipe Jacking, the pipe is the lining. In utility tunneling, the tunnel liner is installed as the tunnel excavation progresses. Liner systems include steel or concrete liner plates and steel ribs with wood lagging. The liners are used to provide temporary ground support.

The process involves removing soil from the front cutting face and installing a liner to form a continuous support structure. The tunnel is normally constructed between two access shafts. The procedure consists of four major steps:

- Soil excavation.
- Soil removal.
- Segmental liner installation.
- Line and grade control

The work normally includes workers within the pipe excavating and removing spoils as well as setting the liner sections. Since workers are inside the pipes, the normal minimum inside diameter of the tunnel is 42 in.

### **18.3.8 Geotechnical Explorations for Trenchless Methods**

For trenchless installations within State rights of way, a minimum of two borings per 150 feet of trenchless pipe should be completed. The borings should be completed to a minimum of 5 feet or twice the pipe diameter below the invert elevation, whichever is deeper. In general, sampling should be continuous, and certainly within two pipe diameters above and below the proposed pipe centerline. Groundwater depth should be monitored through the use of piezometers or wells where necessary.

One issue somewhat unique to HDD installation is the potential for exploratory boreholes to serve as pathways for drilling fluids to escape. For most other geotechnical explorations, the boreholes are located as close as possible to the proposed construction. However, geotechnical borings for HDD installation should be located a minimum of 25 feet from the proposed alignment.

#### **Selection of Trenchless Method**

The selection of a particular trenchless technology for use in a project will be guided by a number of non-geotechnical issues including budget, site access, and pipe diameter. Geotechnical conditions will also limit the number of options available and may rule out trenchless methods entirely.

Characterization of subsurface conditions within the proposed pipeline alignment has a significant impact on the overall project success. The most critical conditions to address are gradation (fine grained cohesive, fine grained non-cohesive, coarse grained, etc.), the presence of cobbles or boulders, the presence of rock, the soil density or stiffness, and the depth to groundwater. Guidance prepared by NCHRP indicates the potential for success for a variety of trenchless methods versus the anticipated soil conditions. The table below is derived from that guidance.

**Table 18-2 NCHRP, Synthesis of Highway Practice 242, Trenchless Installation of Conduits Beneath Roadways**

N Blowcount (Standard Penetration Test)	Cohesive Soils (Clay)			Cohesionless Soils (Sand/Silt)			High Ground Water	Boulders	Full Face Rock
	N<5 (Soft)	5<N<155 (Firm)	N>15 (Stiff)	N<10 (Loose)	10<N<30 (Medium)	N>30 (Dense)			
Auger Boring (AB)	○	●	●	○	●	●	X	≤ 33% φ <sup>1</sup>	≤ 12 ksi
Microtunneling (MT)	●	●	●	●	●	●	●	≤ 33% φ <sup>1</sup>	≤ 30 ksi
Maxi/Midi-HDD	○	●	●	○	●	●	○	○	≤ 15 ksi
Mini-HDD	○	●	●	○	●	●	○	X	X
Impact Molding/Soil Displacement	○	●	●	X	●	○	X	X	X
Pipe Ramming	●	●	●	●	○	○	○	≤ 90% φ	X
Pipe Jacking (PJ) with TBM	○	●	●	○	●	●	○		≤ 30 ksi
Pipe Jacking with Hand Mining (HM)	X	●	●	○	●	●	X	≤ 95% φ	○
Utility Tunneling (UT) with TBM <sup>2</sup>	○	●	●	○	●	●	○		≤ 30 ksi
Utility Tunneling with Hand Mining (HM)	○	●	●	○	●	●	○	≤ 95% φ	●

●: Recommended ○: Possible X: Unsuitable (based on the assumption that work is performed by experienced operators using proper equipment)

1 Size of largest boulder versus minimum casing diameter (φ).

2 Ground conditions may require either a closed face, earth pressure balance, or slurry shield.

# **Chapter 19 - Construction Recommendations and Reporting**



## **Chapter Contents**

<b>Chapter 19 - Construction Recommendations and Reporting</b> .....	<b>19-1</b>
19.1 General.....	19-3
19.2 Roadway Construction Support .....	19-3
19.3 Bridge Construction Support .....	19-3
19.3.1 Spread Footing Construction.....	19-4
19.3.2 Driven Pile Construction.....	19-4
19.3.3 Drilled Shaft Construction .....	19-5
19.4 References .....	19-9
Appendix 19-A: Pile Inspector Graph.....	19-9
Appendix 19-B: Hammer Approval Letter.....	19-10

## **List Of Figures**

Figure 19-1 Pile Inspector Graph .....	19-9
--	------



## 19.1 General

Construction recommendations are included in the project Special Provisions or shown on the **contract** plans. Construction recommendations can also be included in the final geotechnical report as appropriate and may include discussions or recommendations on the following items:

- Shoring **or temporary retaining wall** requirements
- Control of groundwater in excavations
- Temporary excavation slopes
- Difficult pile driving conditions
- Boulders or other obstructions expected in the area of foundation construction or excavations
- Existing foundations in the area of proposed foundations or excavations
- Monitoring of adjacent structures or facilities (preconstruction surveys)
- Underwater acoustic monitoring of pile driving or “bubble curtains”
- Monitoring of fill settlement and excess pore pressure
- Existing utilities, drainage pipes or other feature that may influence foundation construction

## 19.2 Roadway Construction Support

It is prudent for the Geotechnical Engineer and/or project Engineering Geologist to be familiar with, the [Oregon Standard Specifications for Construction](#) (particularly, **Section 00330-Earthwork**) and provide construction assistance:

- Review material properties of proposed embankment,
- Review any embankment settlement monitoring data,
- Assist with assessment of unanticipated subgrade stabilization needs,
- Assist with solutions to drainage problems or other groundwater issues,
- Provide solutions and options for dealing with unstable cut slopes if they arise,
- Review of proposed blasting plans.

## 19.3 Bridge Construction Support

Provide review of contractor submittals and provide construction support as needed for the following general items related to bridge foundation construction:

- Review the stability of temporary excavation cut slopes and shoring submittals,
- Review of foundation designs for false work,
- Review of foundations for temporary work bridges or detour bridges,
- Review cofferdam designs,
- Review and assist in approval of change orders regarding foundation related items such as changes to material specifications or foundation materials,
- Drilled shaft and pile hammer submittals.

### **19.3.1 Spread Footing Construction**

Oregon Standard Specifications for Construction (Section 00510- Structure Excavation and Backfill) is used for the construction of spread footings and the Geotechnical Engineer . should be familiar with this Section). Provide inspection services to the field as requested to verify that the foundation materials exposed at the footing foundation elevation are the same materials as assumed in design and suitable for foundation support. If the materials are not as assumed and are not suitable for footing construction, provide recommendations to the construction office regarding how to proceed with foundation construction. Consult with the structure designer and other project personnel, as necessary, if significant changes to footing elevations are required.

### **19.3.2 Driven Pile Construction**

The Geotechnical Engineer should be familiar with the Oregon Standard Specifications for Construction (Section 00520- Driven Piles) and the Boilerplate Special Provisions for Section 00520 which supplement the Standard Specifications. The final pile record books is sent to the HQ Bridge Engineering Section office at the completion of the project. These records are scanned into a database for future reference.

Construction support for pile foundation projects typically consists of the following review process and documentation:

- Review and approval of the Pile & Driving Equipment Data Form.
  - The contractor is required to submit a completed Pile & Driving Equipment Data Form. If the form is not complete or unclear, request a resubmittal from the PM office. This review consists of verifying that the contractor’s hammer meets the requirements of the standard specifications, which typically means the proposed hammer will provide sufficient field energy to drive the piles to the required minimum tip elevation and develop the required nominal resistance with a driving resistance within the allowable range of 3 to 15 blows per in.
  - If the piles are driven to bearing based on the FHWA dynamic formula, simply check to see that, for the required nominal resistance, the estimated hammer field energy will result in a resistance between 3 and 15 blows per in. The maximum rated hammer energy is not used in this evaluation since hammers rarely reach this level of performance.
  - If the piles are accepted based on wave equation (WEAP) analysis, check the contractor’s WEAP analysis to see that the correct input values were used, the analysis was performed properly, and the predicted pile stresses are below the maximum stresses allowed. Also, check to see that the predicted resistance is between 3 and 15 blows per in.
  - If swinging leads are proposed, a clear method of bracing, anchoring or fixing the bottom of the leads to maintain proper hammer-pile alignment throughout the pile installation.

- Provide final pile driving criteria to the field.
  - If the hammer does not meet the requirements of the specifications, provide a letter to the PM office rejecting the hammer and documenting the reasons for the rejection. Once the hammer is accepted, a letter stating so is sent to the project manager along with the final driving criteria.

The final pile driving criteria usually consists of an inspectors graph showing the required resistance in blows per inch as a function of hammer stroke (for open-end diesel hammers) or field energy. An example is attached in Appendix 18-A: Pile Inspector Graph. A table showing the required resistance as a function of hammer stroke (for a fixed nominal resistance) may also be provided.

At this time in the pile hammer review and approval process, any important pile installation problems or issues that might arise is communicated to the project manager and the pile inspector in the pile hammer approval letter. The following issues are discussed:

- Pile freeze (setup) period, if required, and proper procedures to follow,
- Any anticipated difficult driving conditions and damage potential,
- Potential for piles running long and possible solutions,
- Preboring requirements,
- Vibration monitoring,
- Dynamic pile testing requirements and procedures.

An example of a pile hammer approval letter is shown in Appendix 18-B: Hammer Approval Letter.

For open-end diesel hammers, the hammer stroke must be determined during pile driving for use in determining bearing resistance. A saximeter is a small hand-held device that measures and records hammer stroke and other pile driving information during driving. These devices are available for loan to the field from the HQ Bridge Engineering Section for use in measuring and monitoring the field hammer stroke and other data. Saximeters are primarily recommended for monitoring stroke for open-end diesel hammers and are helpful in assessing overall hammer performance.

### 19.3.3 Drilled Shaft Construction

The Geotechnical Engineer should be familiar with the Oregon Standard Specifications for Construction (Section 00512-Drilled Shafts) and the Boilerplate Special Provisions for Section 00512 which supplement the Standard Specifications. The project Special Provisions may contain several specifications pertaining to drilled shaft construction that are unique to a given project.

Proper inspection is a crucial element in the drilled shaft construction process. All drilled shaft inspectors are certified in drilled shaft inspection procedures.

Construction support for drilled shaft projects typically consists of the following items:

- Review and approval of the drilled shaft installation plan and other submittals (see *Section 0512.40 of the Standard Specifications*). This review and approval is coordinated closely with the structural designer. Shaft construction methods can affect both the structural and geotechnical capacity of drilled shafts and so both disciplines are involved in this review.
- Attend drilled shaft preconstruction meetings with the drilled shaft subcontractor, prime contractor, and construction staff.
- Review and approve crosshole sonic log test results. Coordinate the review and approval of CSL test results closely with the structural designer. See [Section 19.3.3.1](#) for details regarding the CSL testing and evaluation procedures.
- Review proposed drilled shaft repair plans (as needed).
- Provide construction support and advice to the construction office during shaft construction regarding any difficulties in shaft construction or to answer any questions the inspector may have. Help insure the proper inspection is taking place and the proper inspection forms are being completed.

Work with the inspector to make sure the shaft is being constructed in the foundation materials that were assumed in design. If changes to the estimated shaft tip elevations are necessary, work with the structural designer and project staff to determine acceptable revised shaft tip elevations.

### **19.3.3.1 Crosshole Sonic Log (CSL) Testing & Evaluation Procedures**

CSL testing, in combination with a quality field inspection, are the primary methods used by ODOT for the quality control and acceptance of drilled shafts. CSL testing is not always a conclusive test and the results often require interpretation and further in-depth review. The CSL test results by themselves can sometimes be misleading. Therefore, all inspection records and forms are provided to the CSL reviewer to use in combination with the CSL test results in determining shaft acceptance. It is highly recommended that the Geotechnical Engineer and bridge designer both understand, and be familiar with, CSL testing procedures and have training in the use and interpretation of CSL test results.

The following procedures are used when conducting CSL testing for quality control of drilled shafts on ODOT projects.

### **19.3.3.2 CSL Field Testing**

- Contractor provides the CSL subcontractor to do the testing. This is included in the contract with bid items for the number of CSL tests per bridge. The qualifications of the CSL contractor are submitted for approval as part of the Drilled Shaft Installation Plan.
- CSL testing is performed according to ASTM D6760-02.
- CSL testing is performed on the first shaft constructed and others as described in *Section 00512* of the special provisions or as directed by the Engineer.



- Additional shafts are tested if construction methods change or shaft construction results in questionable quality shafts. This is especially true for uncased shafts, excavated below the water table.

### **19.3.3.3 CSL Test Results**

- CSL test results are forwarded to both the geotechnical engineer and the bridge designer for review, (regardless of what the CSL report from the contractor says).
- Both engineers concur that the shaft is acceptable or needs further investigation.
- Structural and/or geotechnical analysis may be necessary at this point to assess the load carrying capacity of the shaft based on interpretation of the CSL test results and inspection reports.

### **19.3.3.4 Further Testing/Inspection**

If an anomaly or obvious defect is detected in the CSL testing, it may warrant further investigation to verify that it does indeed exist and to further quantify the extent and material properties of the material in the affected zone. If additional investigation appears necessary, review all the shaft inspection forms and confer immediately with the drilled shaft Inspector regarding all aspects of shaft construction to determine what could have happened at the depth of the anomaly.

If further investigation is deemed necessary, the following procedures are considered to further quantify the affected zone:

- First, thoroughly review the inspection records of the drilled shaft in question and review the closest drill log to see if there is a correlation between the detected anomaly and something that occurred during the shaft construction process and/or related to the soils or groundwater conditions.
- Consider performing additional CSL testing after some period of time to see if the anomaly is the result of delayed concrete set or curing. Check concrete mix design to see if admixtures and retarders were used which could delay concrete set.
- If practical, excavate around the perimeter of the shaft to expose near-surface defects.
- Consider using CSL tomography (3D Imaging) at this time to try and better define the extent of the anomaly.
- If required, perform core drilling at the locations and depths of suspected defects.
- Insert downhole cameras (in drilled core holes) for visual examination of defects.

### **19.3.3.5 Core Drilling**

If core drilling is necessary, the procedures outlined below is followed:

- Plan the number, location, and depth of all core holes based on the CSL test results and inspection reports. Target the area(s) where the CSL results indicate possible defects. Do not allow the contractor to select core hole numbers, locations and depths.

- Use either double or triple tube-coring equipment that will result in maximum recovery and minimal damage to the recovered concrete core.
- Carefully log all core holes using methods similar to those used for typical geotechnical bore holes, closely measuring depths, rate of advancement, any sudden drops in drill steel (indicating voids), percent recovery, concrete quality, breaks, fractures, inclusions and anything that does not indicate solid, good quality concrete.
- Core at least 3" away from any rebar, if possible, and do not core through any steel reinforcement without the clear, expressed approval of the structural designer.
- Take photos of the core recovery.
- Keep notes of any driller remarks regarding the nature and quality of the shaft concrete.
- Keep the contractor (or Drilled Shaft subcontractor) informed throughout this investigation. The core holes may be able to be used by the contractor for repairing any shaft defects.
- Cored holes could also be filled with water and used for additional CSL testing.
- If possible:
  - Do core breaks (qu) on suspected core samples retrieved from defect area.
  - Use down-hole cameras to help quantify the extent of defect area.

#### 19.3.3.6 Shaft Defects and Repairs

Based on the results of the additional investigation work and an assessment of the shaft integrity, the bridge and Geotechnical Engineers determine if a defect is present that requires repair. This determination is based on an assessment of the effect the defect has on the shaft's ability to perform as designed (both for geotechnical and structural purposes).

**Note:**

If a shaft defect is determined to be present, it is the contractor's responsibility to submit a repair plan and repair the defect at no cost to ODOT.

All shaft repair proposals are submitted to the Geotechnical Engineer and bridge designers for review and approval. Shaft repair is not be allowed without written approval of the Engineer-of-Record. Grout repair of minor shaft voids may be allowed with approval of the Engineer-of-Record, if the CSL tubes are left open to verify shaft integrity after grouting. If shaft defects are severe enough to warrant complete shaft replacement or redesign, the contractor shall submit a plan for the redesign or replacement according to *Section 00512.41*.

If no shaft defects are found, ODOT may be responsible for paying the investigation costs and additional approved compensation to the contractor for delaying drilled shaft construction due to the additional investigation work. If any defects are found, regardless of whether they are repaired or not, the full cost of the shaft investigation (coring and/or other work) is paid by the Contractor with no time extension.

### 19.3.3.7 Remaining Shafts

The cause of any defects is determined, if at all possible, so the contractor can use modified shaft construction procedures and avoid repeating the same defects in the remaining drilled shafts on the project. A modified drilled shaft installation plan, showing these modifications to the installation procedures, is submitted for approval.

## 19.4 References

This section blank intentionally.

## Appendix 19-A: Pile Inspector Graph

### Geary Canal Bridge No. 18142; Bent 4

Qult = 295 kips

PP18x0.375, Delmag D25-32

L = 103', Qs = 95%

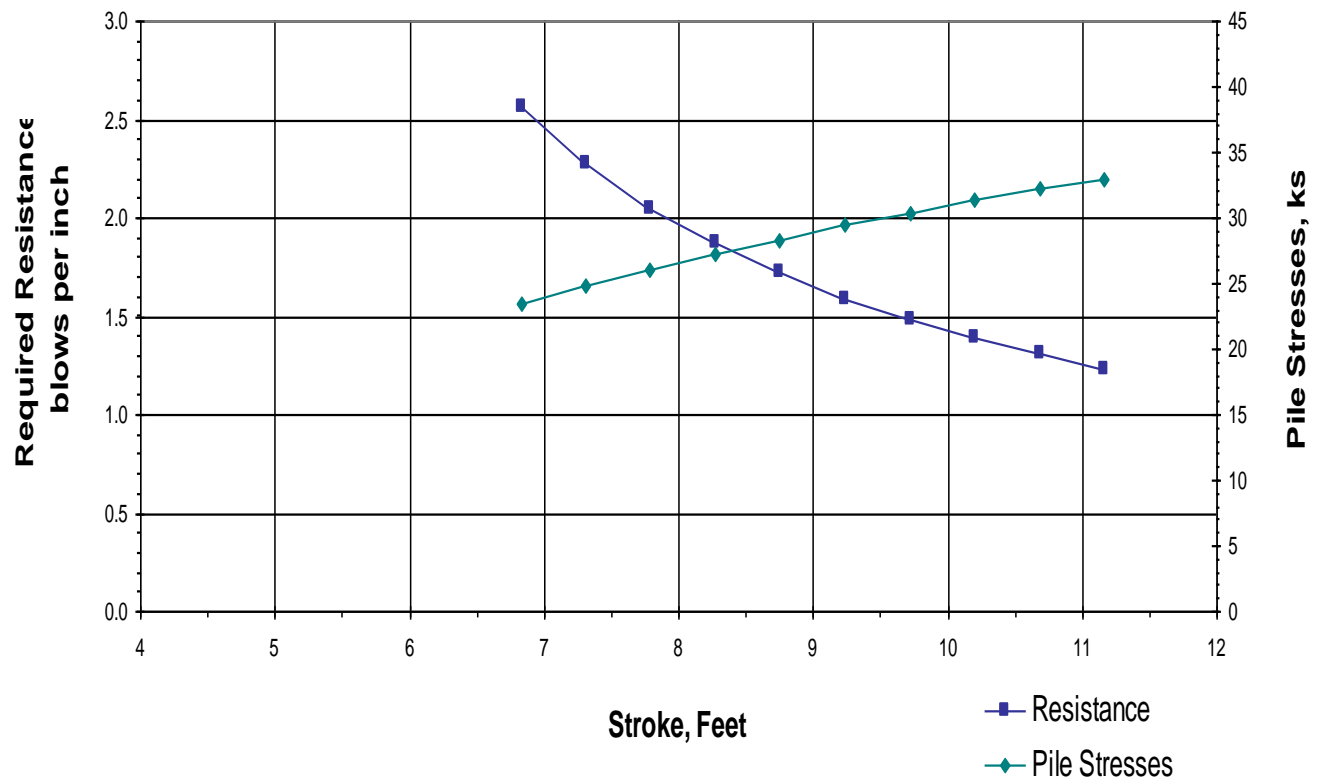

Figure 19-1 Pile Inspector Graph

## Appendix 19-B: Hammer Approval Letter

TECHNICAL SERVICES BRANCH  
INTEROFFICE MEMO

Bridge Engineering Section  
Office Phone: (503) 986-4200  
Fax Phone: (503) 986-3407

August 24, 2010

File Code:

**TO:** Joe Manager  
Project Manager

**FROM:** Bob Geotech, P.E.  
Geotechnical Engineer

**SUBJECT:** Pile Hammer Submittal  
Jackson School Road Interchange Section  
Bridge 19592  
Contract 13023  
Washington County

The Pile and Driving Equipment Data Sheet submitted by the contractor has been reviewed and the hammer is approved for use in driving the permanent piles for the new bridge. The contractor has submitted an ICE 60-S diesel hammer. The serial number of the hammer was not provided. Please obtain this hammer serial number from the contractor and forward it to our office. The pile driving criteria provided in the table below applies to Bents 1 and 3. A graph is also attached relating the hammer stroke to the blow count (resistance) required for bearing and the predicted maximum pile compressive stresses related to hammer blow count. All pile driving criteria was based on a wave equation analysis.

Nominal Resistance, **Rn. = 515 kips**

Stroke (ft)	Blows/Inch
10.5	2.5
10.0	4.0
9.5	5.0
9.0	6.0
8.5	7.0
8.0	8.0
7.5	10.0

The hammer needs to be running with a stroke of at least 7.5 feet. Pile resistance will probably not be obtained on the initial drive of the estimated pile lengths and pile freeze will likely be required at both bents. The minimum freeze period per ODOT specifications is 24 hours before restrike. At least 1 in 10 piles should be freeze tested for acceptance. This means at least 2 piles at each bent should be freeze tested.

The predicted pile driving stresses slightly exceed the allowable for ASTM A 252 Grade 2 steel but we understand from the information the contractor has provided that the steel piling will meet (or exceed) Grade 3 steel (45 ksi). This substitution of higher grade steel is acceptable. Pile driving stresses should not be a concern using the higher grade steel.

A saximeter is available from our office for measuring the field hammer stroke. Please contact me at (503) 555-1234 if you'd like to check it out or if you have any questions.

**Attachments:**

- Pile Inspector Graph: ICE 60-S
- Pile and Driving Equipment Data Sheet

cc: C13023 File

Jackson School Rd. Intchg. Section  
Bridge No. 19592; Bents 1 & 3  
Rn = 515 kips  
PP16x0.50", L = 85 ft., ICE Model I-60s Hammer

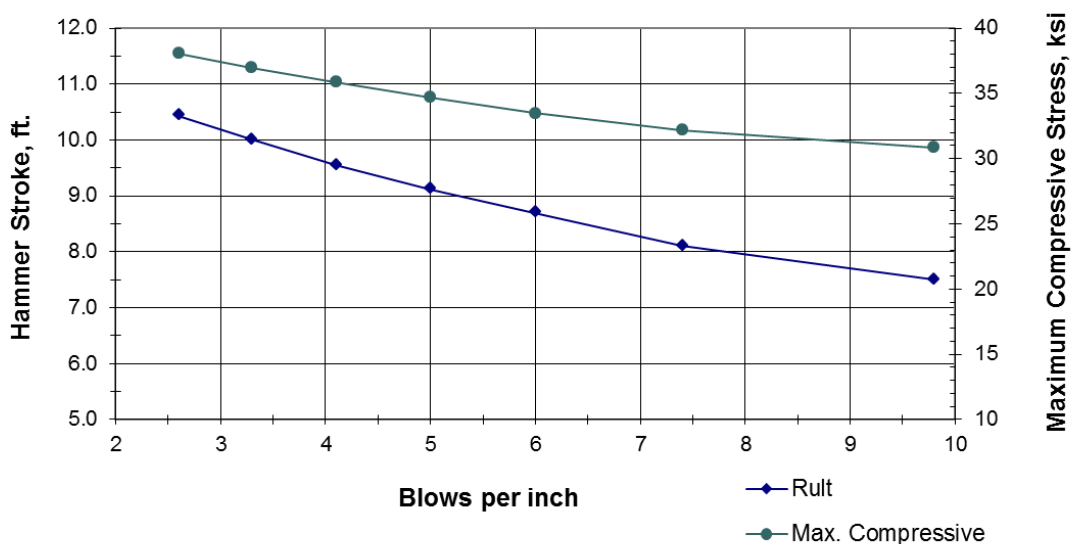

# Chapter 20 - Geotechnical Reporting and Documentation



## Chapter Contents

<b>Chapter 20 - Geotechnical Reporting and Documentation .....</b>	<b>20-1</b>
20.1 General.....	20-3
20.2 General Reporting Requirements .....	20-3
20.3 Quality Control.....	20-4
20.4 Geotechnical Reporting Document Requirements.....	20-4
20.4.1 Geology Documentation .....	20-4
20.4.2 Geotechnical Memo .....	20-9
20.4.3 Geotechnical Reports .....	20-11
20.5 Geotechnical Data Sheets .....	20-19
20.5.1 Location of Geotechnical Data Sheets in Project Plans .....	20-20
20.5.2 Sheet Layout and Content.....	20-20
20.5.3 Layout .....	20-20
20.5.4 Plan.....	20-21
20.5.5 Profile.....	20-21
20.5.6 Sections and Cross-Sections.....	20-22
20.5.7 Unit Descriptions.....	20-23
20.6 Additional Reporting Requirements for Structure Foundations .....	20-23
20.6.1 Spread Footings.....	20-24
20.6.2 Pile Foundations.....	20-26

20.6.3 Drilled Shafts .....	20-32
20.6.4 Geotechnical Report Checklist for Bridge Foundations.....	20-35
20.6.5 Geotechnical Report Distribution .....	20-35
20.6.6 Retaining Walls.....	20-36
20.7 Geotechnical Design File Information.....	20-39
20.7.1 Documentation for Preliminary Geotechnical Design .....	20-40
20.7.2 Documentation for Final Geotechnical Design .....	20-40
20.7.3 Geotechnical File Contents.....	20-42
20.8 References .....	20-43
Appendix 20-A Geotechnical Report Review Checklist.....	20-44

### List Of Tables

---

Table 20-1 Example Presentation of Soil Design Parameters for Spread Footing Design .....	20-24
Table 20-2 Example Table for Summarizing Resistance Factors used for Spread Footing Design .....	20-25
Table 20-3 Example Table for Spread Footing Bearing Resistance Recommendations .....	20-25
Table 20-4 Example Table of Resistance Factors for Pile Design.....	20-27
Table 20-5 Pile Resistances & Estimated Lengths (Br. 12345) .....	20-28
Table 20-6 Soil Parameters for Lateral Load Analysis (non-liquefied soil condition).....	20-29
Table 20-7 Example of Wave Equation Input Table.....	20-31
Table 20-8 Example presentation of soil design parameters for design of non-gravity cantilever walls and anchored walls.....	20-38

### List Of Figures

---

Figure 20-1 Example of Spread Footing Bearing Resistance Recommendations. (from FHWA-RC/TD-10-001 (2010) .....	20-26
Figure 20-2 Example Plots of Pile Bearing and Uplift Resistance. ....	20-27
Figure 20-3 Typical shaft bearing resistance plots (all limit states). ....	20-34
Figure 20-4 Example of bearing resistance recommendations for gravity walls .....	20-37
Figure 20-5 Example of lateral earth pressures for gravity wall design.....	20-37
Figure 20-6 Example presentation of lateral earth pressures for non-gravity cantilever and anchored wall design.....	20-39

## 20.1 General

ODOT geotechnical engineers, engineering geologists and consultants working on ODOT projects produce geotechnical reports, engineering geology reports and other various design memorandums, documents and products in support of project definition, project design, and final PS&E development. Also produced are project specific Special Provisions, plan details, boring logs, Geotechnical Data Sheets and the final project geotechnical documentation. Information developed to support these geotechnical documents are retained in the **Geotechnical project folder** in Project Wise. The information includes project site data, regional and site specific geologic data, exploration logs, field and laboratory test results, instrumentation and monitoring data, interpretive drawings, design calculations, and construction support documents. This chapter provides standards for the development, content, and review of these documents and records, with the exception of borings logs, which are covered in [Chapter 5](#) and Materials Source Reports, which are covered in [Chapter 4](#).

## 20.2 General Reporting Requirements

In general, all geotechnical design recommendations **are** documented with either a stamped hard copy to the project file or a stamped electronic copy. Verbal recommendations that influence contract plans or specifications or result in design changes **are** followed up with a formal document. Some geotechnical recommendations may involve very minor design or construction issues and therefore minimal review or documentation is required. The level of review and documentation depends on the type and complexity of the design or construction issue and the experience and qualifications of the engineer performing the work.

A geotechnical document (either a design memorandum or standard report) is required for most highway projects involving any significant geotechnical design elements such as earthwork, landslides or rock slopes, or structure foundations. When geotechnical design is required for a project, this work should be documented in the form of either technical memoranda or reports that summarize the work performed and the resulting design recommendations and products. For reports that cover **minor** individual project elements, a geotechnical design memorandum may suffice **as the final geotechnical document**. Geotechnical Memos are also prepared for larger, more complex projects, including all new bridges and bridge replacements in order to provide preliminary recommendation for the Bridge and Roadway designers in preparation of the TS&L Report and to be included in the DAP submittal. **A final geotechnical document is issued for all geotechnical project design elements.**

E-mail may be used for **communicating preliminary geotechnical information or recommendations during the design process**. E-mails may **also** be used to transmit review of construction submittals. **In either case**, a print-out of the e-mail **are** included in the project file. For time critical geotechnical designs sent by e-mail that are not preliminary, the e-mail **is immediately** followed up with a stamped **document**. A copy of the e-mail **is maintained** in the project file.



## 20.3 Quality Control

Quality control of geotechnical design work is an ongoing process occurring regularly throughout the entire design process. The ODOT quality control process is described in detail in [Chapter 2](#).

## 20.4 Geotechnical Reporting Document Requirements

The geotechnical information and types of recommendations that are provided in the Geology Summary, Geotechnical Memo, and Geotechnical Report are provided in the sections that follow.

### 20.4.1 Geology Documentation

The Geology Summary would typically consist of the first sections of the Geotechnical Design Report. For projects where the design team deems it prudent, the Geology Report may be produced as a fully executed memo or report. The report is considered “final” by the POR and Reviewer and ready to present to the report users for their review and comment at 50 percent of DAP.

The Geology Summary is prepared by, or under the direct supervision of, the Engineering Geologist POR assigned to the project. The Engineering Geologist POR should maintain close communication with the Geotechnical Engineer POR to ensure that the required information is obtained and provided.

Regardless of the format of the Geology Summary, the intent is to suitably document the geologic conditions of a project site. The timely creation of this document avoids the loss of valuable geologic information, which provides a future real return on current investments by the agency in engineering geologic investigations. Further, since the geotechnical analysis and design rely upon the information transmitted in the Geology Summary, it must be completed in sufficient time to allow for the preparation of the Geotechnical Memo.

The following reporting guidelines are provided for use in developing the Geology Summary. Note that the majority of this information will also be included, section by section, in the front section of the Geotechnical Report. The list below is intended to be a general list and is by no means intended to be inclusive but all items that apply to the project are included in the summary.

#### **Description**

A general description of the project scope, project elements, and project background.

### **Surface Conditions**

Description of Project site surface conditions and current land use.

### **Regional and Site Geology**

This section describes the site stress history and depositional/erosional history, bedrock and soil geologic units, etc. from available geologic literature and/or from previous geologic reconnaissance reports.

### **Regional and Site Seismicity**

This section identifies the active seismic sources meeting the criteria in (AASHTO Seismic Design Guide) affecting the site including nearby active faults. This section is generally only included in reports addressing structural elements (e.g., bridges, walls, etc.) and major earthwork projects. Refer to [Chapter 7](#) for additional seismic design criteria that may be required.

### **Summary of Office Studies**

A summary of the office studies collected on the site, including final construction records for previous construction activity at the site, as-built bridge drawings or other structure layouts, pile records, boring or test pit logs or other subsurface information, geologic maps or previous or current geologic reconnaissance results.

### **Summary of Field Exploration**

A summary of the field exploration conducted, if applicable. Provide a description of the methods and standards used, as well as a summary of the number and types of explorations and field testing that were conducted. Include a plan map (or data sheet) in the appendix showing the locations of all explorations. Also include a description of any field instrumentation installed and its purpose, data and results. Provide final exploration logs in the report appendices along with any other field test data such as cone penetrometer, pressure meter, vane shear tests, or shear wave velocity profiles.

### **Summary of Laboratory Testing**

A summary of the laboratory testing conducted. Provide a description of the methods and standards used as well as a summary of the number and types of tests that were conducted. Provide the detailed laboratory test results in the report appendices.

### **Soil and Rock Materials and Subsurface Conditions**

This section includes descriptions of the soil/rock units encountered, but also how the units are related at the site, and their geologic origin. The soil and rock units are discussed in terms of the relevance and influence the materials and conditions may have on the proposed construction. Groundwater conditions should be described in this section of the report, including the identification and discussion of any confined aquifers, artesian pressures, perched water tables, potential seasonal variations, if known, any influences on the

groundwater levels observed, and direction and gradient of groundwater, if known. The groundwater elevation is a very important item and should be provided in the report. The measured depth of groundwater levels, and dates measured, should be noted on the exploration logs and discussed in the report. It is important to distinguish between the groundwater level and the level of any drilling fluid. In addition, groundwater levels encountered during exploration may differ from design groundwater levels. Any artesian or unusual groundwater conditions are to be noted as this often has important effects on foundation design and construction. If rock slopes are present, discuss rock structure, including the results of any field structure mapping (use photographs as needed), joint condition, rock strength, potential for seepage, etc.

**Bedrock**

- Rock identification and description according to the ODOT Soil and Rock Classification system ([Chapter 5](#)).
- Geologic age of the formation.
- Distribution, origin, structure, geometry, and geomorphology of each bedrock unit.
- Structural features/Structural Geology
- Weathering profile of each rock unit in the project area. Distribution and extent of weathered and/or altered zones. Differences in properties between fresh and weathered/altered rock.
- Relevant physical properties such as stratigraphic (bedding, inclusions, foliation, etc.) features and overall rock mass strength as well as other characteristics such as cementation, discontinuities, and overall variability throughout the rock mass.
- Rock Mass Rating (RMR) and Geologic Strength Index (GSI).
- Special characteristics or concerns such as excessive slaking after exposure or high variability in rock strength over short distances, etc.
- Any features that may affect project construction or design.

**Surficial or unconsolidated deposits**

- Soil identification and description according to the ODOT Soil and Rock Classification system ([Chapter 5](#)).
- Distribution, geometry, variability, and surficial expression and exposure of units.
- Relative age (if known), origin, depositional history, and mobility of units.
- Physical characteristics such as permeability, structure, and geologic composition of materials.
- Special features such as peats, expansive clays, indications of substantial volume changes, instability, or sensitivity.

**Subsurface Profiles**

Descriptions of soil and rock conditions are illustrated with subsurface profiles (i.e., parallel to roadway centerline) and cross-sections (i.e., perpendicular to roadway centerline) of the key project features.

A subsurface profile or cross-section is defined as a graphical illustration that assists the reader of the geotechnical report to visualize the spatial distribution of the soil and rock units encountered in the borings for a given project feature (e.g., structure, cut, fill, landslide, etc.).

Cross sections and profiles along certain features, such as landslides, may be needed to fully convey the site conditions and subsurface model. These profiles and cross sections help to define a geologic model of the subsurface materials and conditions. As such, the profile or cross-section will contain the existing and proposed ground line, the proposed structure profile or cross-section if one is present, the boring logs (including SPT values, soil/rock units, etc.), and the location of any water table(s). Interpretive information is provided in these illustrations, as appropriate, to adequately and clearly describe and depict the subsurface geologic model. The potential for variability in any of the stratification shown is discussed in the report.

#### **Geotechnical Data Sheets**

An unstamped figure of the final Geotechnical Data Sheets is provided in the Geology Summary and/or the Geotechnical Report.

#### **Surface hydrology and subsurface hydrogeologic conditions**

All surface water features such seeps and springs, wetlands, and bodies of water are clearly located on maps. Groundwater surfaces, water-bearing zones, and aquifers (if existent) are clearly depicted on all subsurface drawings. Soil and rock units that affect groundwater is described and characterized. Variability in precipitation, temperature, water impoundment, etc. and its potential effect on the project site is described in detail. Provide the following additional information::

- Distribution, occurrence, and variation of hydrologic and hydrogeologic features
- Piezometric surface depth, seasonal variation, direction and gradient, and discharge and recharge areas.
- Relationships between surface, and groundwater and geologic and topographic features.
- Evidence for previous water occurrence at the site.
- The possible effects on groundwater that the project will have.
- Permeability of surficial materials that affect infiltration at the site.

**Summary of Geologic Hazards**

Provide a summary of geological hazards identified and their impact on the project design (e.g., landslides, rock fall, debris flows, liquefaction, soft ground or otherwise unstable soils, seismic hazards, etc.), if any. Describe the location and extent of the geologic hazard.

**Engineering Geologic Recommendations**

- Prediction of materials and geologic structures/features that will be encountered in proposed excavations and their impacts on performance and constructability.
- Areas to be avoided with respect to stability or constructability issues with locations clearly depicted on the drawings.
- Excavation considerations such as variable rock projections, groundwater seepage, obstructions, etc.
- Embankment construction considerations such as subdrainage, adhesion, and stability.
- Recommendations for erosion control, environmental mitigation, and stability.
- Suitability of on-site materials for use as engineered fill.
- Potential mitigation strategies for identified geologic hazards.
- Identification of potential material sources and disposal sites.

**Additional Recommendations**

- Additional explorations required to adequately characterize difficult site conditions encountered during design-phase investigations.
- Groundwater testing for construction dewatering or infiltration basin design.
- Rockfall protection measures.
- Subsurface drainage including trench drains, vertical drain wells, pumping, and horizontal drainage.

**Appendices**

Typical appendices include all final exploration logs of borings (showing Unit Description), test pits and any other subsurface explorations (including older exploration logs), Geotechnical Data Sheets (if available), layouts showing boring locations relative to the project features and stationing, subsurface profiles and typical cross-sections that illustrate subsurface stratigraphy at key locations (if available), laboratory test results, and instrumentation measurement results.

The detail contained in each of these sections will depend on the size and complexity of the project or project elements and the subsurface conditions. In some cases, design memoranda that do not contain all of the elements described above may be developed prior to developing a final geotechnical report for the project.

## 20.4.2 Geotechnical Memo

Geotechnical Memos are prepared for larger, more complex projects, including all new bridges and bridge replacements. Regardless of the level of detail, the primary purpose of Geotechnical Memos is to support the Bridge and Roadway designers in preparation of the Bridge TS&L Report and to be included in the DAP submittal. Since the preliminary documentation is typically presented in memo form, this manual uses the term Geotechnical Memo, in spite of the fact that this document could be a fully executed geotechnical report.

A Geotechnical Memo is typically finalized some 75 percent of the way through the DAP timeline. At this stage, the geologic reconnaissance of the project site has been conducted and the subsurface exploration program is substantially complete. Draft gINT drill logs and preliminary geotechnical analysis has been performed to characterize key elements of the design, assess potential hazards, evaluate potential design alternatives and estimate preliminary costs.

The Geotechnical Memo is prepared by the Geotechnical Engineer POR assigned to the project. The POR should maintain close communication with the Bridge, Hydraulic and Roadway designers, as well as the Geotechnical Engineer Reviewer and Engineering Geologist POR, to ensure that the required information is provided.

### Purpose

Provide a brief statement as to the purpose and intent of the Geotechnical Memorandum. This section should note that the recommendations included in this memorandum are preliminary and based on our office studies and initial phase of subsurface exploration. Recommendations may change and this should be considered an important part of the iterative design process.

### Introduction

Given the early and somewhat preliminary nature of the Geotechnical Memorandum, this section is crucial and should not be overlooked. The Introduction needs to clearly describe the project as currently understood by the Geotechnical Engineer POR. Presenting current project details addresses the reticence Geotechnical Engineers may have with respect to providing usable recommendations for a project that will inevitably change. By fully describing the project scope, expected elements including structures, preliminary foundation loads, and other parameters provided by others and assumed by the Geotechnical Engineer, the limitations associated with the recommendations can be well understood by the users of the report.

### Seismic Design Criteria

The presentation of complete and accurate seismic design criteria is important with respect to allowing the project designers to proceed with the preliminary design of structural elements, including bridges. The initial portion of this section should include an evaluation of active faults within 6 miles of the project site and an opinion as to the potential for fault rupture at the site (based on the proximity of known faults).

With respect to seismic design of structures, the important topics to be covered by this section include site class and site amplification factors developed in accordance with AASHTO guidelines. Further, the memo should include recommended design response spectra for Life Safety and Operational performance levels developed using the ODOT Design Response Spectrum Program and Cascadia Subduction Zone ARS.

### **Geologic Hazards**

Describe the geologic hazards that may impact the proposed project including landslides, debris flow, rock fall, potential sink holes or lava tubes, liquefaction, soft ground or otherwise unstable soils, seismic hazards, and severe erosion conditions. Describe the location and extent of the geologic hazard as well as potential mitigation strategies.

### **Liquefaction**

For projects where liquefaction will have an impact on the design of the project, the Geotechnical Memorandum should confirm information already provided to the design team. A preliminary evaluation of liquefaction should be completed as soon as possible in the project and if significant, communicated to the design team.

The liquefaction section should include a discussion of liquefaction potential and likely impacts on the project, including estimates of settlement, lateral spread, and downdrag on piles. Recommendations for liquefaction mitigation, if appropriate, should also be discussed.

### **Earthwork Recommendations**

The memo should contain a discussion of significant earthwork related issues identified. These may include recommendations for the inclination of embankment and cut slopes, a discussion of the suitability of onsite material for use as compacted embankments, and the feasibility of wet weather construction.

### **Structure Recommendations**

The recommendations for bridge structures should include a discussion of the foundation loads (Service, Strength, Extreme, etc.), types considered and a rationale for the selected foundation system. In order to inform the bridge type size and location effort, the memo should include selected foundation type(s) as well as a description of anticipated foundation size(s), number, and location(s). All load combinations, lateral and axial loads, including liquefaction-induced loads, are included. The memo includes recommendations for the preliminary design of abutment walls and wingwalls including coefficients of lateral earth pressure ( $K_a$ ,  $K_o$ ,  $K_p$ ).

For deep foundations, L-Pile Parameters are provided for each interpreted soil layer, the thickness, model soil type,  $\gamma'$ , cohesion intercept, friction angle, P-Y modulus, and E50. This information is typically provided in tabular format where parameters begin at the top of the deep foundation.

For retaining walls, the memo discusses the retaining wall types considered and rationale for selected type as well as the retaining wall size, location, and the earth pressure diagrams and recommended coefficients of lateral earth pressure ( $K_a$ ,  $K_o$ ,  $K_p$ ).

#### **Liquefaction Mitigation**

If liquefaction is identified, a description of potential mitigation strategies that could be used to achieve the project design objectives.

### **20.4.3 Geotechnical Reports**

In general, final geotechnical reports are developed based on an office review of existing geotechnical data for the site, a detailed geologic review and geologic model of subsurface conditions of the site, and a complete subsurface investigation program, meeting AASHTO and FHWA standards. Design analysis are then conducted based on the results of the field investigation work, combined with any institution or laboratory test data, and the resulting design recommendations are included in the geotechnical report along with construction recommendations and project special provisions as appropriate.

Geotechnical reports for bridge foundation design projects are used to communicate and document the site and subsurface conditions along with the foundation and construction recommendations to the structural designer, specifications writer, construction personnel, and other appropriate parties. The importance of preparing a thorough and complete geotechnical report cannot be overemphasized. The information contained in the report is referred to during the design phase, the pre-bid phase, during construction, and occasionally in post-construction to assist in the resolution of contractor claims.

The following reporting guidelines are provided for use in developing the final Geotechnical Report. Include all items below that apply to the project.

#### **Description**

A general description of the project scope, project elements, and project background.

#### **Surface Conditions**

Description of Project site surface conditions and current land use.

#### **Regional and Site Geology**

This section describes the site stress history and depositional/erosional history, bedrock and soil geologic units, etc. from available geologic literature or from previous geologic reconnaissance reports.

#### **Regional and Site Seismicity**

This section identifies the major seismic sources affecting the site including nearby active faults. This section is generally only included in reports addressing structural elements (e.g., bridges, walls, etc.) and major earthwork projects. Refer to [Chapter 7](#) for additional seismic design criteria that may be required.



**Summary of Office Studies**

A summary of the office studies collected on the site, including final construction records for previous construction activity at the site, as-built bridge drawings or other structure layouts, pile records, boring or test pit logs or other subsurface information, geologic maps or previous or current geologic reconnaissance results.

**Summary of Field Exploration**

A summary of the field exploration conducted, if applicable. Provide a description of the methods and standards used, as well as a summary of the number and types of explorations and field testing that were conducted. Include a plan map (or data sheet) in the appendix showing the locations of all explorations. Also include a description of any field instrumentation installed and its purpose, data and results. Provide exploration logs in the report appendices along with any other field test data such as cone penetrometer, pressure meter, vane shear tests, or shear wave velocity profiles.

**Summary of Laboratory Testing**

A summary of the laboratory testing conducted, if applicable. Provide a description of the methods and standards used as well as a summary of the number and types of tests that were conducted. Provide the detailed laboratory test results in the report appendices.

**Soil and Rock Materials and Subsurface Conditions**

This section includes a description of the soil/rock units encountered, and also how the units are related at the site, and their geologic origin. The soil and rock units are discussed in terms of the relevance and influence the materials and conditions may have on the proposed construction. Groundwater conditions are described in this section of the report, including the identification and discussion of any confined aquifers, artesian pressures, perched water tables, potential seasonal variations, if known, any influences on the groundwater levels observed, and direction and gradient of groundwater, if known. The groundwater elevation is a very important item and is provided in the report. The measured depth of groundwater levels, and dates measured, are to be recorded on the exploration logs and discussed in the report. It is important to distinguish between the groundwater level and the level of any drilling fluid. In addition, groundwater levels encountered during exploration may differ from design groundwater levels. Any artesian or unusual groundwater conditions are noted as this often has important effects on foundation design and construction. If rock slopes are present, discuss rock structure, including the results of any field structure mapping (use photographs as needed), joint condition, rock strength, potential for seepage, etc.

**Subsurface Profiles**

Descriptions of soil and rock conditions are illustrated with subsurface profiles (i.e., parallel to roadway centerline) and cross-sections (i.e., perpendicular to roadway centerline) of the key project features.

A subsurface profile or cross-section is defined as a graphical illustration that assists the reader of the geotechnical report to visualize the spatial distribution of the soil and rock

units encountered in the borings for a given project feature (e.g., structure, cut, fill, landslide, etc.).

Cross sections and profiles along certain features, such as landslides, may be needed to fully convey the site conditions and subsurface model. These profiles and cross sections help to define a geologic model of the subsurface materials and conditions. As such, the profile or cross-section will contain the existing and proposed ground line, the structure profile or cross-section if one is present, the boring logs (including SPT values, soil/rock units, etc.), and the location of any water table(s). Interpretive information is provided in these illustrations, as appropriate, to adequately and clearly describe and depict the subsurface geologic model. The potential for variability in any of the stratification shown is discussed in the report.

### **Geotechnical Data Sheets**

An unstamped figure of the final Geotechnical Data Sheets is provided in the Geotechnical Data Report and/or the Geotechnical Report.

### **Summary of Geologic Hazards**

Provide a summary of geological hazards identified and their impact on the project design (e.g., landslides, rock fall, debris flows, potential sink holes or lava tubes, liquefaction, soft ground or otherwise unstable soils, seismic hazards, and severe erosion conditions etc.), if any. Describe the location and extent of the geologic hazard.

### **Analysis of Unstable Slopes**

For analysis of unstable slopes (including existing settlement areas), cuts, and fills, provide the following:

- Analysis approach,
- Assessment of failure mechanisms,
- Determination of design parameters (including residual shear strength as applicable),
- Factors of safety used, and
- Any agreements within ODOT or with other customers regarding the definition of acceptable level of risk.

Included in this section, would be a description of any back-analyses conducted, the results of those analyses, comparison of those results to any laboratory test data obtained, and the conclusions made regarding the parameters that are used for final design.

### **Recommendations for Stabilization of Unstable Slopes**

Provide geotechnical recommendations for stabilization of unstable slopes (e.g., landslides, rock fall areas, debris flows, etc.). This section provides the following information and recommendations as appropriate:

- A discussion of the mitigation options available,

- Detailed recommendations regarding the most feasible options for mitigating the unstable slope,
- A discussion of the advantages, disadvantages, and risks associated with each feasible option,
- Cost estimates for each option are included, as appropriate.

### **Earthwork Recommendations**

Provide a summary of geotechnical recommendations for earthwork (embankment design, cut slope design, drainage design, and use of on-site materials as fill). This section provides the following recommendations as applicable to the project:

- Embankment design recommendations, such as the maximum embankment slope angles, allowed for stability and any measures that need to be taken to provide a stable embankment (e.g., geosynthetic reinforcement, wick drains, staged embankment construction, surcharge, lightweight materials, use of rip rap etc.),
- Estimated embankment settlement and settlement rate, along with any recommendations for mitigating excess post construction settlement. Include any recommendations for foundation improvement (sub-excavation) such as the need for removal of any unsuitable materials beneath the proposed fills and the extent of these areas,
- Cut slope design recommendations, including the maximum cut slopes allowed to maintain the required stability. Recommendations for control of seepage or piping, erosion control measures and any other mitigation measures required to provide a stable slope is included,
- On-site, “select,” soil units are identified as to their feasibility for use as embankment material, discussing the type of material for which the select soils are feasible, the need for aeration, the effect of weather conditions on their usability, and identification of select materials that are not be used in embankment construction. The potential of non-durable rock materials are identified and discussed, as appropriate.

### **Rock Slope and Rock Excavation Recommendations**

Provide geotechnical recommendations for rock slopes and rock excavation. Such recommendations include, but are not limited to the following:

- Recommended rock slope design and fallout area,
- Rock scaling,
- Rock bolting/dowelling, and other stabilization requirements (if appropriate), including recommendations to prevent erosion/undermining of intact blocks of rock,
- Internal and external slope drainage requirements,
- Feasible methods of rock removal such as controlled blasting or ripping,

- Detailed plans and cross sections as needed to clearly depict the areas requiring rock slope stabilization and the methods and designs recommended.

### **Bridge and Other Structure Recommendations**

Provide geotechnical recommendations for bridges, tunnels, hydraulic structures, and other structures. See [Section 20.7](#) for additional information required for bridge foundation designs. This section provides the following minimum information:

- Discussion of foundation options considered,
- Recommended foundation options, and the reason(s) for the selection of the recommended option(s),
- Foundation design recommendations:
  - For strength limit state – nominal and factored bearing resistance, lateral and uplift resistances,
  - For service limit state – settlement limited bearing, and any special design requirements,
  - For extreme event limit state – nominal bearing, uplift, and lateral resistance, and soil spring values,
  - Design recommendations for scour, when applicable.

### **Seismic Design Parameters and Recommendations**

Provide the following for seismic design parameters and recommendations:

- Site location latitude and longitude decimal format to at least four digits,
- Three point design spectra using the General Procedure in AASHTO for the 2014 USGS seismic hazard maps for the 1000-year events,
- Eighteen point design spectra based on the CSZ Earthquake event (for bridges on and west of US97)
- Site Class and Soil Coefficients ( $F_{pga}$ ,  $F_a$ ,  $F_v$ ),
- Design Response Spectrum (from AASHTO General Procedure and/or Ground Response Analysis).

### **Summary of Liquefaction Analysis**

Provide a summary of liquefaction analysis. If liquefaction is predicted, provide:

- Estimates of embankment deformations including predicted settlement and lateral displacements,
- An assessment of potential bridge damage and approach fill performance for both the 500 and 1000 year events,
- Estimates of seismic-induced downdrag loads (if applicable),
- Soil properties for both the liquefied and non-liquefied soil conditions, for use in the lateral load analysis of deep foundations,

- Reduced foundation resistances,
- Liquefaction mitigation design recommendations (if necessary),
- Results of ground response analysis and site-specific response spectra (if applicable),
- Earth pressures on abutments and walls in buried structures.

**Retaining Wall and Reinforced Slope Recommendations**

Provide geotechnical recommendations for retaining walls and reinforced slopes. This section provides a discussion of:

- Wall/reinforced slope options and the reason(s) for the selection of the recommended option(s),
- Foundation type and design requirements:
  - For strength limit state - bearing resistance, lateral and uplift resistance if deep foundations selected,
  - For service limit state - settlement limited bearing, and any special design requirements,
  - Seismic design parameters and recommendations (e.g., design acceleration coefficient, extreme event limit state bearing, uplift and lateral resistance if deep foundations selected) for all walls except for ODOT Standard Retaining Walls,
  - Design considerations for scour when applicable,
  - Lateral earth pressure parameters (provide full earth pressure diagram for non-gravity cantilever walls and anchored walls).

**Non-Proprietary Walls and Reinforced Slopes**

For non-proprietary walls/reinforced slopes requiring internal stability design (e.g., geosynthetic walls, soil nail walls, and all reinforced slopes), provide the following:

- Minimum width for external and overall stability,
- Embedment depth,
- Bearing resistance,
- Settlement estimates,
- Soil/rock adhesion values,
- Soil reinforcement spacing, strength, and length requirements in addition to dimensions to meet external stability requirements,
- Or anchored walls, provide achievable anchor capacity, no load zone dimensions, and design earth pressure distribution.

**Proprietary Walls**

For proprietary walls, provide the following:

- Minimum width for external and overall stability,

- Embedment depth,
- Bearing resistance,
- Settlement estimates,
- Design parameters for determining earth pressures.

### **Traffic Structure, Soundwall and Building Recommendations**

Provide geotechnical recommendations for traffic structures, soundwalls and buildings. This section provides the following minimum information:

Provide the following foundation information:

- Discussion of foundation options considered,
- Recommended foundation options, and the reason(s) for the selection of the recommended option(s),
- Foundation design recommendations.

For mast arm and strain pole foundation lateral resistance, provide soils information required lateral, axial, and in some instances torsional resistance. This includes soil type (cohesive or cohesionless), unit weight, soil friction angle or un-drained shear strength and groundwater level. Provide the highest groundwater level anticipated at any time during the life of the structure. If site conditions do not allow the use of the Broms method, provide soils information required for the LPILE or strain-wedge analysis methods as appropriate.

For structures that have standard foundation design drawings, provide the site-specific soil designation (i.e. "Good," "Average" or Type "A" or "B," etc.) for use with the standard drawing. Also provide recommendations on whether or not the foundation soils and site conditions meet all requirements shown on the standard drawing, such as slope limits and settlement criteria. If soil or site conditions are variable along the length or under the foundation, clearly delineate these areas on a plan map and provide recommendations for each delineated area.

If the foundation materials or site conditions do not meet the requirements for using the standard drawings, such as conditions of hard rock or very soft, "Poor" soils, provide soil unit descriptions, soil properties, groundwater information and other design recommendations as required for design of the foundation to support the proposed structure. This includes the following information as a minimum:

- Description of the soil units using the ODOT Soil & Rock Classification System,
- Ground elevation and elevations of soil/rock unit boundaries,
- Depth to the water table,
- Soil design parameters, including effective unit weight(s), cohesion,  $\phi$ ,  $K_a$ ,  $K_p$ , and/or P-y curve or strain-wedge data as appropriate,
- The allowable bearing capacity for spread footings and estimated wall or footing settlement (and differential settlement) as appropriate,

- Overall stability factor of safety,
- Any foundation constructability issues resulting from the soil/rock or groundwater conditions.

#### **Recommendations for Infiltration/Detention Facilities**

Provide geotechnical recommendations regarding infiltration rate, impact of infiltration on adjacent facilities, effect of infiltration on slope stability, if the facility is located on or near a slope, stability of slopes within the pond, and foundation bearing resistance and lateral earth pressures (vaults only). See the “*ODOT Hydraulics Manual*” for additional details on what is required for these types of facilities.

#### **Recommendations for Non-Standard Foundation Designs**

Provide construction recommendations and any special provisions that may be required for non-standard foundation designs. This may include things such as non-standard sub-excavation, backfill and compaction requirements, blasting specifications or the use of temporary casing for drilled shafts.

For buildings provide the following as appropriate:

- Nominal resistance or bearing capacities and associated resistance factors or factors of safety as appropriate,
- Settlement calculations and the amount of total allowable and differential settlement described for the structure.

Provide recommendations regarding temporary slopes, stabilization of unstable ground, ground improvement and retaining wall recommendations including:

- Any foundation constructability issues resulting from the soil/rock or groundwater conditions,
- Earthwork recommendations, including recommendations for fill or cut slopes, material requirements, compaction, ground stabilization or improvements and provisions for drainage as applicable.

#### **Long-Term Construction Monitoring Needs**

In this section, provide recommendations on the types of instrumentation needed to evaluate long-term performance or to control construction, the required schedule for reading instruments, length of monitoring period, how the data is used to control construction or to evaluate long-term performance, and the zone of influence for each instrument. Include recommendations for the proper installation and protection of all instrumentation during construction.

In relation to construction considerations, address issues of construction staging, shoring needs and potential installation difficulties, temporary slopes, potential foundation installation problems, earthwork constructability issues, dewatering, etc.

#### **Construction Issues and Recommendations**

In this section provide information on adverse subsurface conditions, site constraints, and other issues that could have a significant impact on the contractor's selection of means and methods of construction and on the overall project costs. Adverse subsurface conditions may include the presence of cobbles and boulders, existing foundations or other buried structures, high groundwater or artesian conditions, soil voids, very soft unstable (caving) soils, expansive soils, contaminated soils and other conditions that need to be recognized and understood by the contractor and Agency personnel.

Site constraints such as low overhead clearance, areas of difficult access or restricted construction, buried utilities, nearby structures that may be sensitive to construction vibrations and other site restrictions that could adversely affect construction is provided.

References made to environmental permits, noise regulations, and other documents relating to the construction of the geotechnical elements of the project are accurate, factual and pertain specifically to geotechnical construction are documented.

### Appendices

Typical appendices include all exploration logs of borings (showing Unit Description), test pits and any other subsurface explorations (including existing exploration logs), Geotechnical Data Sheets, design charts for foundation bearing and uplift, P-y curve input data, design detail figures, layouts showing boring locations relative to the project features and stationing, subsurface profiles and typical cross-sections that illustrate subsurface stratigraphy at key locations, laboratory test results, instrumentation measurement results, and input and output of all analyses performed.

The detail contained in each of these sections will depend on the size and complexity of the project or project elements and the subsurface conditions. In some cases, design memoranda that do not contain all of the elements described above may be developed prior to developing a final geotechnical report for the project.

## **20.5 Geotechnical Data Sheets**

This is not an inclusive list of specific features that require Geotechnical Data Sheets. A judgment-based decision on when to include Geotechnical Datasheets is expected to have better outcomes than prescriptively listing when to include them in the Project Plans. **A Geotechnical Data Sheet is produced for projects where a subsurface investigation has been conducted.**

If subsurface information is needed for project design, it is included for project construction. Geotechnical Data Sheets are expected for projects with geotechnical elements unless there is a clear case for not providing them.



## **20.5.1 Location of Geotechnical Data Sheets in Project Plans**

The recent development of CADD standards and ODOT plan sheet title blocks facilitates the inclusion of Geotechnical Data Sheets with the structure(s) or feature(s) within the contract plan set. This was not previously possible due to the differing standards between sections within the Agency. Geotechnical Data Sheets are to be located with the structure or feature that it was developed for in the plan set. Placing the Geotechnical Data Sheets sequentially with the structure or feature provides contractors and others involved with construction the information developed during the design and eases retrieval for future reference.

Geotechnical Data Sheets are to be placed after the plan sheet and before the profile sheet for the related structure or feature. When a structure or feature has the plan and profile depicted on one single sheet then the Geotechnical Data Sheet immediately follow that sheet. Data Sheets developed for Cuts, Fills, and Embankments, will be associated with the appropriate Plan View sheet and follow the Profile Sheet for that section. When more than one Geotechnical Data Sheet is produced for a project, a Geotechnical Data Sheet Index depicting the locations is to be provided. Duplication and overlap of information on Geotechnical Data Sheets is avoided.

See the Bridge CAD Manual for direction on plan sheet numbering and title block information for Geotechnical Data Sheets. For structures requiring a structure number for the Bridge Data System (BDS), a Drafter with appropriate BDS access will provide drawing numbers for Geotechnical Data Sheets.

## **20.5.2 Sheet Layout and Content**

The content of a Geotechnical Data Sheet is based on the Final Logs produced by the Project Engineering Geologist. Location and placement of explorations, legend development, and unit descriptions, among other attributes, are the responsibility of the Project Engineering Geologist.

## **20.5.3 Layout**

Geotechnical Data Sheets can be arranged in multiple ways to depict subsurface conditions. The minimal content to display on a Geotechnical Data Sheet is a plan and profile showing the subsurface conditions that underlie the subject structure/feature with the profile along the roadway centerline. This is the principle layout that is to be provided for every structure/feature but it does not restrict additional plans on separate sheets that aid in depicting the underlying geologic conditions. In some instances, a Section or Cross-section may be used in lieu of a Profile.

Additional profiles offset from centerline or along structure alignments such as wall centerlines or the sides of bridges may also be produced. Cross-sections may be used in place of, or to supplement the profile for wide features or where complex geology exists. Sections may also be

drawn at skewed angles to the centerline where needed to best display subsurface conditions or to show a specific element such as the principal axis of a landslide.

Geotechnical Data Sheets in the contract plans must be stamped by **appropriate** Professional of Record (POR) in accordance with the Agency's Stamping Policy.

## **20.5.4 Plan**

The plan view shows existing structure(s) (if applicable) or feature(s) in addition to the proposed structure(s) or feature(s). For bridges, existing and proposed bent and abutment locations **are** located and labeled. The footprint or general layout of other structures and features **are** shown. These features **are** drawn on the Geotechnical Data Sheet at a scale suitable for easy viewing of applicable features.

Provide the alignment to be used for construction of the structure/feature. Stationing sufficient to orient the drawing and to provide reference to the structure/feature elements being constructed. Stationing follows the CPM requirements for stationing from left to right on the sheet. Provide the project alignment on all sheets whether or not structure-specific alignments are used for construction. The location of explorations such as borings, test pits, cone penetrometer tests, seismic lines or other subsurface explorations must be shown. Each location is identified with correct symbology assigned by the CPM. Provide the survey location directly adjacent to the exploration number. This survey information includes the exploration number, the name of the alignment, station, and offset with Right or Left offset indicated. For projects without alignments, the coordinates of the exploration would be shown instead. These coordinates are the same as the project coordinate system. If cone penetrometer, pressure meter, vane shear, packer or other in-situ testing is performed, a note stating that the results of these tests are available in the Geotechnical Report.

Provide water body boundaries and flow direction, if applicable, that lie within the plan view of the structure or feature. Label the water body with the name of that body of water or use unnamed if there is not a name. Intermittent waterways are labeled or depicted as such with the applicable symbology.

Provide existing contour lines as gray-shaded. Contours must be displayed with numeric labels indicating their elevation at an appropriate interval without unit labels. Provide the contour interval on the plan sheet. Features or lines that do not serve a clear purpose with respect to conveying information about the site conditions to be omitted.

## **20.5.5 Profile**

The profile view shows the engineering geology interpretation of the subsurface conditions at the structure or feature location. This interpretation is depicted by geologic graphic columns or "stick logs" that represent each exploration at the station and elevation at which they occur along the alignment. Geologic graphic columns consist of separate sections that represent the

subsurface materials by patterned symbology. An Engineering Geologic Unit Description is used to describe the materials represented by the patterns in a legend format. The legend-style Engineering Geologic Unit Descriptions are separate and distinct from the standard legend showing the standard graphic symbols.

Each Engineering Geologic graphic column is labeled at the top with the exploration number offset (optional), elevation, and the date the boring was completed.

Additional information with depth is shown alongside the Engineering Geologic graphic column. Samples and in-situ test results are shown with their designated symbols at the depth they were taken or performed along the right side of the graphic column. SPT (Standard Penetration Test) intervals are to be labeled by their N-Value. Sample intervals are denoted by the vertical length of the symbol. Continuous sampling methods such as rock coring are shown by dimensions labeled with the sample name. Groundwater is shown on the left side of the graphic column. The standard groundwater symbols are placed at the depth of the highest and lowest groundwater levels measured. These symbols are labeled with the dates that the readings were taken. Provide a statement if no groundwater was encountered.

Provide Rock Core Tables to show specific rock core data for each boring. Provide a table for each Engineering Geologic graphic column with rock coring with the core run, percent recovery, hardness, Rock Quality Designation (RQD), and date obtained. Place these tables below the profile where the corresponding Engineering Geologic graphic column occurs. Sheet space limitations may require a different distribution of the rock core tables.

Profiles are shown along the alignment(s) used for construction as described in the preceding LAYOUT section. Provide each Engineering Geologic graphic column aligned with the corresponding exploration symbol on the plan view immediately above the profile. Profiles are displayed on station and elevation grids. Label stations on the bottom of the grid. Include labeled elevations on the left side of the grid. Grid lines may be subdued to avoid conflict with Engineering Geologic graphic columns showing geologic interpretations or the various Engineering Geologic graphic column labels. Profiles are labeled as "PROFILE AT 'LINE NAME'".

Avoid depicting numerous explorations on a single profile, which obscure data or lead to a cluttered appearance. Several options can be used to alleviate this situation:

- Expand the horizontal scale of the drawing
- Use supplemental sections, profiles, or cross-sections. Provide supplemental sections, profiles, and cross-sections in the Geotechnical Data Sheet format.

## **20.5.6 Sections and Cross-Sections**

Sheets displaying sections or cross-sections are typically used to improve understanding for large structures/features or complex subsurface conditions. However, they are required for all landslides and for cuts, and embankments that are large enough to necessitate subsurface exploration. Cross-sections should be considered for wide or skewed structures, structures

founded on spread footings, and where variable-lengths of deep foundations result from high local relief or geologic structure.

Plan views may be shown on section and cross-section sheets where needed. Illustrate the section line on the Plan View of the primary geotechnical data sheet and label with the section arrow and designation when section sheets are utilized.

Illustrate the existing ground line along the section and the Engineering Geologic graphic columns as described above under Profile. Sections drawn on a grid with the elevations labeled on the left and right side of the grid table and the horizontal offset from centerline labeled on the bottom of the grid or on the bottom and top of the grid. Grid lines may be subdued to avoid conflict with Engineering Geologic graphic columns showing interpretations or the various Engineering Geologic graphic column labels.

Cross-sections developed perpendicular to the centerline alignment may be labeled as "SECTION 'Station' ". Sections developed at angles other than perpendicular are labeled as "SECTION 'alphabetic letter – alphabetic letter' ".

## **20.5.7 Unit Descriptions**

Provide unit descriptions and their corresponding symbols in a legend-style format on each Geotechnical Data Sheet. The Unit Descriptions contain descriptions for the engineering geologic units on that specific sheet. The unit descriptions on a Geotechnical Data Sheet are a compilation of the physical and engineering properties from the final logs. These unit descriptions are compiled from the descriptions on the logs of explorations represented on the individual sheet. Engineering geologic unit descriptions and properties are often singularly consolidated in the Engineering Geology or Geotechnical Engineering reports. Do not use broad-ranging descriptions on a Geotechnical Data Sheet unless every exploration for the project is represented on that data sheet. The Project Geologist must compile the description for the legend based on the explorations shown on that sheet. Project-specific information may be conveyed on a Data Sheet from other referenced project data sources. An example of this would be a specific note on a boulder-bearing Engineering Geologic unit that did not encounter boulders in the sheet's specific borings, but were found elsewhere in the same unit or presented in the published literature.

## **20.6 Additional Reporting Requirements for Structure Foundations**

The geotechnical designer provides the following additional information to the structural designer for use in the design of structure foundations:

## 20.6.1 Spread Footings

If spread footings are recommended, provide the following information in the geotechnical report:

- Elevations of the proposed footings, a clear description of the foundation materials the footings are to be constructed on and minimum cover requirements,
- Specify whether or not the footings are to be keyed into rock. Check with the bridge designer to see if a “fixity” condition is required in rock. On sloping rock surfaces, work with the structural designer to determine the best “bottom-of-footing” elevations,
- Nominal bearing resistance available for the strength and extreme event limit states,
- Settlement limited nominal bearing resistance for the specified settlement (typically 1 inch) for various effective footing widths likely to be used for the service limit state,
- Resistance factors for each limit state, and
- Minimum footing setback on slopes and embedment depths.

The allowable footing/wall settlement is a function of the structure type and performance criteria and the structural designer should be consulted to establish allowable structure settlement criteria.

To evaluate sliding stability and eccentricity, the geotechnical designer provides resistance factors for both the strength and extreme event limit states for calculating the shear and passive resistance in sliding. Also the soil parameters  $\phi$ ,  $K_p$ ,  $\gamma$ ,  $K_a$ , and  $K_{ae}$  are provided for calculating the passive and active resistances in front of and behind the footing.

To evaluate soil response and development of forces in foundations for the extreme event limit state, the geotechnical designer provides the foundation soil/rock shear modulus values and Poisson’s ratio ( $G$  and  $\mu$ ).

The geotechnical designer evaluates overall stability and provides the maximum (un-factored) footing load which can be applied to the design slope and still maintain an acceptable safety factor (1.5 for the strength and 1.1 for the extreme event limit states, which is the inverse of the resistance factor). A uniform bearing stress, as calculated by the Meyerhof method, is used for this analysis. Example presentations of the LRFD footing design recommendations to be provided by the geotechnical designer are shown in Table 20-1, 20-2, 20-3 and Figure 20-1.

**Table 20-1 Example Presentation of Soil Design Parameters for Spread Footing Design**

Parameter	Abutment Piers	Interior Piers
Soil Unit Weight, $\gamma$ (soil above footing base level)	x	x
Soil Friction Angle, $\Phi$ (soil above footing base level)	x	x
Active Earth Pressure Coefficient, $K_a$	x	x

Parameter	Abutment Piers	Interior Piers
Passive Earth Pressure Coefficient, $K_p$	x	x
Seismic Earth Pressure Coefficient, $K_{ae}$	x	
Soil Unit Weight, $\gamma$ (soil above footing base level)	x	x

**Table 20-2 Example Table for Summarizing Resistance Factors used for Spread Footing Design**

Resistance Factor, $\phi$			
Limit State	Bearing	Shear Resistance to Sliding	Passive Pressure Resistance to Sliding
Strength	x	x	x
Service	x	x	x
Extreme Event	x	x	x

**Table 20-3 Example Table for Spread Footing Bearing Resistance Recommendations**

Bent	Footing Size	Footing Elev.	$R_n$	$\phi$	$\phi R_n$

Figure 20-1 Example of Spread Footing Bearing Resistance Recommendations. (from FHWA-RC/TD-10-001 (2010))

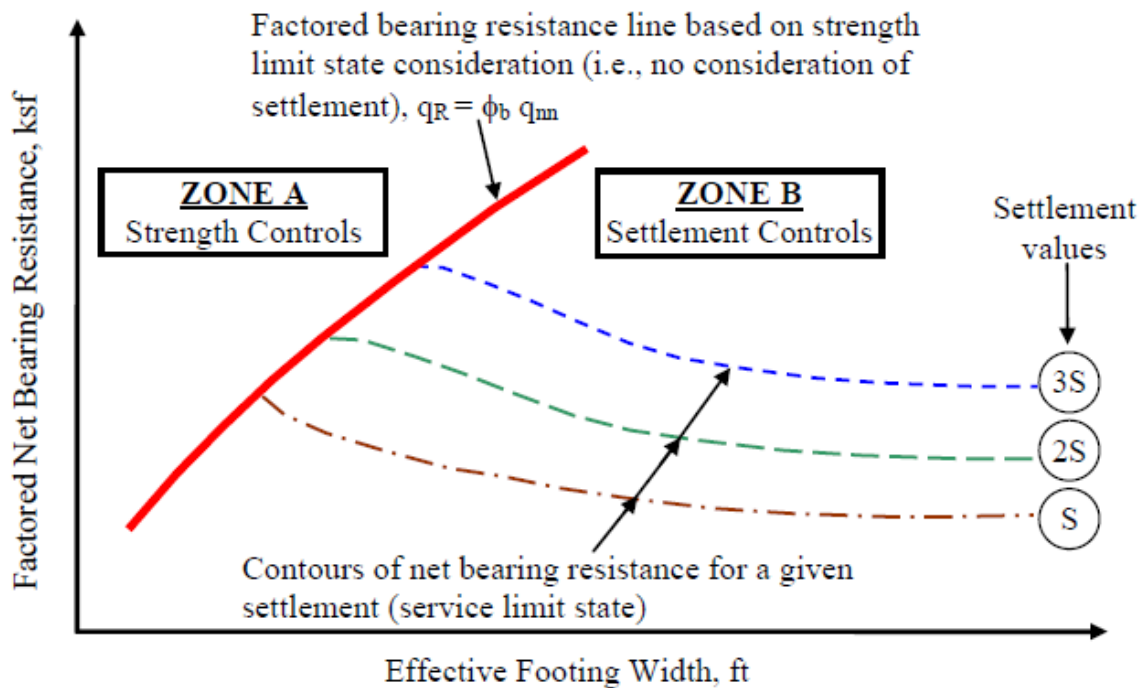

## 20.6.2 Pile Foundations

### 20.6.2.1 Bearing Resistance

Pile bearing resistance recommendations may be provided using either of the following two approaches.

1. A plot of the nominal bearing resistance ( $R_n$ ) is provided as a function of depth for various pile types and sizes (for strength and extreme event limit states). This design data is used to determine feasible nominal pile resistances and the corresponding estimated pile depths required. See Figure 20-2 for an example of this pile data presentation.
2. If the required nominal bearing resistance ( $R_n$ ) is known, the estimated depth at which it could be obtained may be provided in tabular format for one or more selected pile types and sizes.

Resistance factors for bearing resistance for all limit states is provided (see Table 20-4 for an example).

Figure 20-2 Example Plots of Pile Bearing and Uplift Resistance.

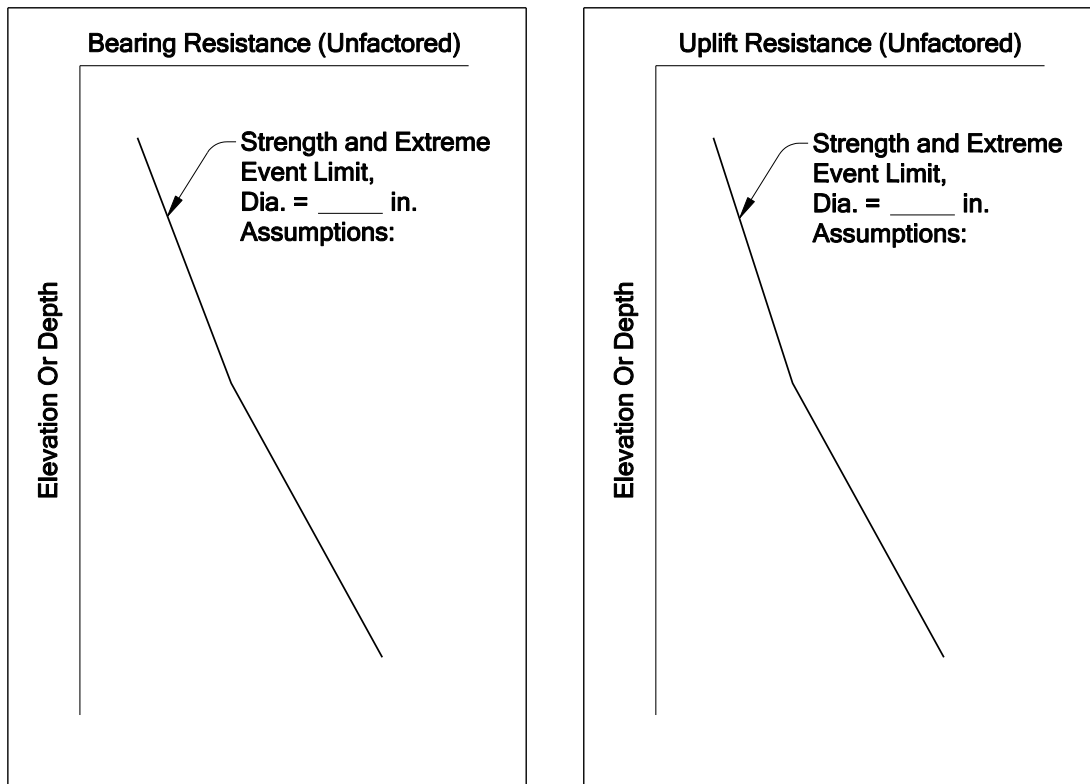

Table 20-4 Example Table of Resistance Factors for Pile Design.

Resistance Factor, $\phi$		
Limit State	Bearing Resistance	Uplift
Strength	x	x
Service	x	x
Extreme Event	x	x

Once  $R_n$  is known (or the total driving resistance,  $R_{ndr}$ , if applicable) and the cutoff elevation of the pile is obtained from the bridge designer, then the “Engineers Estimated Length” can be determined for steel piles. The Engineer’s Estimated Lengths are required in the project special provisions for each bridge bent. Table 20-5 below is an example of how this information is presented. The table is modified as necessary to account for reduced capacities due to scour, liquefaction, downdrag or other conditions.



Table 20-5 Pile Resistances & Estimated Lengths (Br. 12345)

Pile Type: PP16x0.50"

Bent	R <sub>n</sub> (kips)	φR <sub>n</sub> (kips)	C.O. Elev. (ft.)	Est. Tip Elev. (ft.)	Engr's Est. Length, (ft.)	Req'd. Tip Elev. (ft.)
1	450	180	210	130	80	150
	350	140	210	145	65	150
2	450	180	170	120	50	135
	350	140	170	130	40	135
3	450	180	200	125	75	140
	350	140	200	135	65	140

Legend & Table Notes:

R<sub>n</sub> = Nominal pile bearing resistance

φR<sub>n</sub> = Factored pile bearing resistance, (φ based on field method used to determine the required nominal pile bearing resistance)

C.O. = Pile cutoff elevation

### 20.6.2.2 Downdrag

If downdrag loads are anticipated, the following is provided:

- Estimated downdrag load, DD,
- Depth of the downdrag zone, or thickness of the downdrag layer,
- Downdrag load factor,
- Cause of the downdrag (settlement due to vertical stress increase, liquefaction, etc.),
- Also the total driving resistance, R<sub>ndr</sub>, (the required nominal pile driving resistance), taking into account the downdrag loads, is provided.

### 20.6.2.3 Scour

If scour is predicted, the depth of scour and the skin friction lost due to scour, R<sub>scour</sub>, is provided. The total driving resistance, R<sub>ndr</sub>, (the required nominal resistance), taking the loss of friction due to scour into account, is provided.

### 20.6.2.4 Uplift Resistance

For evaluating uplift, the geotechnical designer provides the following:

- Nominal (un-factored) and factored uplift resistance,  $R_n$ , either plotted as a function of depth or as a single value for a given minimum tip elevation, depending on the project needs.,
- Skin friction lost, due to scour or liquefaction that is to be applied to the uplift resistance curves, (provided either separately, in tabular form, or include on plots of uplift resistance with depth),
- Resistance factors for either single piles or pile groups (as appropriate).

### 20.6.2.5 Lateral Resistance

The geotechnical designer provides the soil parameters necessary to develop p-y curves and perform the lateral load analysis. The p-y curve soil input data provided for each soil or rock unit as defined by the top and bottom elevations of each unit. Resistance factors for lateral load analysis do not need to be provided, as the lateral load resistance factors will typically be 1.0.

The parameters required are typically those required for the LPILE, GROUP or DFSAP proprietary computer programs and the p-y soil/rock parameters provided is in a format for easy insertion into either of these computer programs. Coordinate with the structural design as necessary to determine which program input values are required. It is important that the geotechnical designer maintain good communication with the structural designer to determine the kind of soil parameters necessary for the lateral load analysis of the structure. If liquefaction of foundation soils is predicted, soil parameters are provided for both the liquefied and non-liquefied soil conditions. Table 20-6 is an example format for presenting the required data for a non-liquefied soil condition.

**Table 20-6 Soil Parameters for Lateral Load Analysis (non-liquefied soil condition).**

**Bridge 12345; Bents 1 & 3**

ELEVATION (ft.) From To		P-y Curve Model*	K (lbs./in <sup>3</sup> )	SOIL PARAMETERS $\gamma$ ,(pci) c,(psi) $e_{50}$ $\phi$				SOIL DESCRIPTION
63.5	55.0	Soft Clay	500	0.06	3.5	.007	--	Sandy Clayey Silt to Silty Clay (fill)
55.0	30.0	Stiff clay without free water	1000	0.07	13	.005	--	Silt w/ trace sand & clay to Clayey Silt, low plasticity
30.0	10.0	Stiff clay without free water	2000	0.072	20	.004	--	Clay to Silty Clay, med.-high plasticity, very stiff

\* For the LPILE program provide the appropriate soil type from the default types listed in LPILE or provide custom P-y curves if necessary.

If lateral loads imposed by special soil loading conditions such as landslide forces are present, the lateral soil force or stress distribution and the load factors to be applied to that force or stress, are provided.

### **20.6.2.6 Required Pile Tip Elevation for Minimum Penetration**

Provide a required pile tip elevation for piles at each bent. The required tip elevation represents the highest acceptable tip elevation that will still provide the required resistances and performance under all loading conditions. The required tip elevation (sometimes referred to as “Minimum Tip Elevation”) is typically based on one or more of the following conditions:

- Pile tip reaching the required bearing layer or depth,
- Providing required uplift resistance,
- Providing required embedment for lateral support,
- Satisfying settlement and/or downdrag criteria,
- Providing sufficient embedment below scour depths or liquefiable layers.

The required pile tip elevations provided in the Geotechnical Report may need to be adjusted depending on the results of the lateral load or uplift load evaluation performed by the structural designer. If adjustments in the required tip elevations are necessary, or if changes in the pile diameter are necessary, the geotechnical designer is informed so that pile drivability and resistance recommendations can be re-evaluated. The required tip elevation may require driving into, or through, very dense soil layers resulting in potentially high driving stresses. Under these conditions a wave equation drivability analysis is necessary to make sure the piles can be driven to the required embedment depth (tip elevation) without damage.

### **20.6.2.7 Pile Tip Reinforcement**

Specify steel pile tip reinforcement if piles are to be driven through very dense granular soils containing cobbles and boulders or for penetration into weak rock. Pile points (H-piles) or shoes (pipe piles) are typically specified. In pipe pile driving conditions where difficult driving through dense sand and gravel is anticipated before reaching the required tip elevation, inside-fit pipe pile shoes are sometimes used to help retard the formation of a soil plug at the pile tip. **Section 02520 of the Boilerplate** Special Provisions must be included in the project specifications for specifying the proper steel grade for pile tip reinforcement and other requirements. Also note that outside-fit pile tip reinforcement (points or shoes) can reduce the friction resistance and this effect is taken into account in design before specifying outside fit tips or shoes.

### 20.6.2.8 Pile Splices

The contractor is responsible for providing the Engineer's Estimated pile length. ODOT pays for splices when piles are driven over the Engineer's Estimated Length. Provide the number of anticipated pile splices that might be needed due to variability of the subsurface conditions. This number of splices is included as a bid item in the contract documents.

### 20.6.2.9 Pile Driving Criteria and Acceptance

The method of construction control and pile acceptance must be specified in the report for each project. All piles are accepted based on field measured pile driving resistances, established by the FHWA Gates equation, wave equation analysis, PDA/signal matching methods or load test criteria.

The pile driving analyzer (PDA) with signal matching (CAPWAP) is also sometimes used on projects where it is economically justified. Full scale static load tests are rarely performed but are recommended for large projects where there is potential for substantial savings in foundation costs.

Typical ODOT practices regarding the use of dynamic driven pile acceptance methods are described as follows:

**FHWA Gates Equation:** For routine pile design projects with nominal pile bearing resistances less than or equal to 600 kips, the default dynamic formula used to establish pile driving criteria is the FHWA Gates Equation. When using this equation a resistance factor of 0.40 is applied to the nominal bearing resistance to determine the factored resistance.

**Wave Equation Analysis Program (WEAP):** Wave Equation driving criteria is generally used for the following situations:

- Nominal pile resistances greater than of 600 kips,
- Where driving stresses are a concern (e.g., short end-bearing piles or required penetration through very dense strata),
- Very long friction piles in granular soils.

A resistance factor of 0.50 is applied to the nominal bearing resistance to determine the factored resistance. When the wave equation method is specified, the contractor is required to perform a wave equation analysis of the proposed hammer and driving system and submit the analysis as part of the hammer approval process. The soils input criteria necessary for the contractor to perform the WEAP analysis needs to be supplied in a table in Section 00520 of the contract special provisions. An example of a completed table that would be provided in the geotechnical report (and special provisions) is shown below.

**Table 20-7 Example of Wave Equation Input Table.**

**Bridge No. 12345; Bents 1 & 2**

Pile Type	Pile Length (ft.)	Quake (in.)		Damping (in./sec.)		Friction Distribution (ITYS)	IPRCS (Note 2)	R <sub>n</sub> (kips)
		Skin	Toe	Skin	Toe			
PP16 x 0.50	85.0	0.10	0.15	0.20	0.20	Note 1	95	620

**Note 1:** Use a rectangular distribution of skin resistance over the portion of the pile underground.

**Note 2:** IPRCS is the percent skin friction (percent of R<sub>n</sub> that is skin friction in the WEAP analysis).

Refer to the **Section 00520 of the Standard and Special Provisions** for additional specification requirements. Provide WEAP input data for the highest (worst-case) driving stress condition, which may not always be for the pile at the estimated tip elevation.

**Pile Driving Analyzer (PDA) with Signal Matching:** Large pile driving projects may warrant the use of dynamic pile testing using a pile driving analyzer for additional construction quality control and to save on pile lengths. Generally the most beneficial use of PDA testing is on projects with large numbers of very long, friction piles driven to high resistance. However, there may be other reasons for PDA testing such as high pile driving stress conditions, testing new pile hammers, questionable hammer performance or to better determine the pile skin friction available for uplift resistance. A resistance factor of 0.65 can be applied to the nominal bearing resistance determined by PDA and signal matching analysis if an adequate number of production piles are tested. *AASHTO Article 10.5.5.2.3* should be referenced for the procedures to use for PDA/Signal Matching pile acceptance. A signal matching (CAPWAP) analysis of the dynamic test data is always performed to determine the axial nominal resistance and to calibrate the PDA resistance prediction methods. The piles are tested after a waiting period if pile setup or relaxation is anticipated.

### 20.6.3 Drilled Shafts

To evaluate bearing resistance, the geotechnical designer provides, as a function of depth and for various shaft diameters, the nominal bearing resistance for end bearing, R<sub>p</sub>, and side friction, R<sub>s</sub>, used to calculate R<sub>n</sub>, for strength and extreme event limit state calculations (see example figures below). For the service limit state, the bearing resistance at a specified settlement, typically 0.5 or 1.0 inch (mobilized end bearing and mobilized side friction) are provided as a function of depth and shaft diameter. See Figure 19.3 for an example of lateral earth pressures for gravity wall design for an example of the shaft bearing resistance information that is provided. Resistance factors for bearing resistance for all limit states are reported.

#### Downdrag

If downdrag loads are anticipated, the following are provided:

- The depth of the downdrag zone, or thickness of the downdrag layer,
- The downdrag load, DD, as a function of shaft diameter,
- The downdrag load factor,
- The loss of skin friction due to downdrag,

- The cause of the downdrag (settlement due to vertical stress increase, liquefaction, etc.).

### **20.6.3.1 Scour**

If scour is predicted, the depth of scour and the skin friction lost due to scour,  $R_{scour}$ , is provided by the Hydraulic Engineer and documented in the report.

### **20.6.3.2 Uplift Resistance**

For evaluating uplift, the geotechnical designer provides, as a function of depth, the nominal and factored uplift resistance. The skin friction lost due to scour or liquefaction that is to be applied to the uplift resistance curves are documented (either separately, in tabular form, or included on the plots of uplift resistance with depth). Resistance factors for either single shafts or shaft groups are reported.

### **20.6.3.3 Lateral Resistance**

Provide soil input values for the LPile, GROUP or DFSAP program as described in Section 19.7.2.5. Coordinate with the structural design as necessary to determine which program input values are required. Resistance factors for lateral load analysis generally do not need to be provided, as the lateral load resistance factors will typically be 1.0.

Figure 20-3 Typical shaft bearing resistance plots (all limit states).

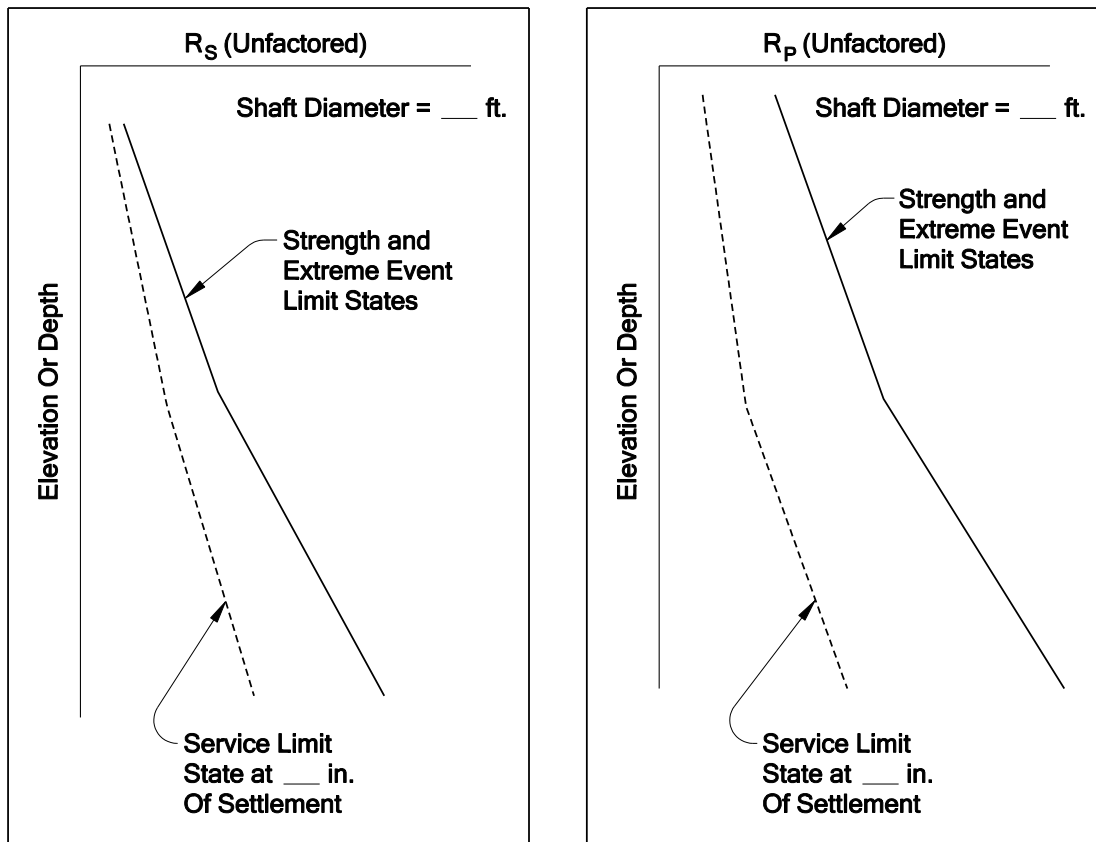

### 20.6.3.4 Crosshole Sonic Log Testing

Access tubes for crosshole sonic log (CSL) testing are typically provided in all drilled shafts unless otherwise recommended by the geotechnical designer. Typically, one tube is provided per foot of shaft diameter with a minimum of 3 tubes provided per shaft. All CSL tubes are 1-1/2" inside diameter Schedule 40 steel pipe conforming to ASTM A53, Grade A or B, Type E, F, or S.

The amount of CSL testing needs to be determined for each project is recommended in the Geotechnical report and shown on the plans. Specify the minimum number of CSL tests to be conducted and the location of these tests. The actual number of tests can be increased, if necessary, during construction depending on the contractor's work performance. The amount of testing that is performed depends on the subsurface conditions, the redundancy of the foundation system and the contractor's work performance. The first shaft constructed is always tested to confirm the contractor's construction procedures and workmanship. Subsequent tests are based on the following guidelines and engineering judgment:

- Test every single-shaft bent,
- Minimum of 1 CSL test per bent (or shaft group) or 1/10 shafts.
- Redundancy in the substructure/foundation,

- Soil conditions (potential construction difficulties like caving soils, ground swelling, and boulders),
- Groundwater conditions (wet holes, artesian conditions).

See [Chapter 18](#) for additional guidelines for CSL testing procedures during construction

### **20.6.3.5 Shaft Reinforcement Lengths in Rock Socket Applications**

For rock socket shaft designs where the top of rock is uncertain (as described in [Chapter 17](#)), provide the following in the Geotechnical Report and in the project special provisions:

- The additional length(s) of shaft reinforcement needed to account for the uncertainty in the top of the bearing layer for rock socket applications,
- The requirement that the contractor's drilled shaft equipment must be capable of drilling the full extra shaft length. This requirement must be included in the project Special Provisions.

### **20.6.4 Geotechnical Report Checklist for Bridge Foundations**

The Geotechnical Report Review Checklist in Appendix 19-A Geotechnical Report Review Checklist is used to check the content and completeness of geotechnical reports prepared for bridge foundation projects. The checklist is completed by the Professional-of-Record for the project. The checklist questions are completed by referring to the contents of the geotechnical report. For each question, a yes, no, or not applicable (N/A) is provided. A response of "I don't know" to any applicable section on the checklist is not to be shown with a check in the "Not Applicable" (N/A) column. All checklist questions answered with "NO" are fully documented on subsequent pages of the checklist.

A copy of the completed checklist, and all comments and explanations, are included with the geotechnical report when submitted for review to ODOT.

### **20.6.5 Geotechnical Report Distribution**

Geotechnical reports are posted on eBIDS and distributed to the following personnel:

- Structure Designer
- Roadway Designer
- Specification Writer
- Project Leader
- Project Manager (more copies if requested for contractors)
- Hydraulic Engineer (if appropriate)



- Project Geologist

## 20.6.6 Retaining Walls

To evaluate bearing resistance for gravity walls, the geotechnical designer provides  $q_n$ , the nominal bearing resistance available, and  $q_{serv}$ , the settlement limited bearing resistance for the specified settlement for various effective footing widths (i.e., reinforcement length plus facing width for MSE walls) likely to be used (see Figure 20-4). Resistance factors for each limit state are also provided. The amount of settlement on which  $q_{serv}$  is based shall be stated. The calculations assume that  $q_n$  and  $q_{serv}$  will resist uniform loads applied over effective footing dimension  $B'$  (i.e., effective footing width  $(B - 2e)$ ) as determined using the Meyerhof method for soil). For footings on rock, the calculations assume that  $q_n$  and  $q_{serv}$  will resist peak loads and that the stress distribution is triangular or trapezoidal rather than uniform. The geotechnical designer also provides wall base embedment depth requirements or footing elevations to obtain the recommended bearing resistance.

To evaluate sliding stability, bearing, and eccentricity of gravity walls, the geotechnical designer provides:

- Resistance factors for both the strength and extreme event limit states for calculating the shear and passive resistance in sliding,
- Soil parameters  $\phi$ ,  $K_p$ ,  $\gamma$  and depth of soil in front of footing to ignore when calculating passive resistance,
- Soil parameters  $\phi$ ,  $K_a$ , and  $\gamma$  used to calculate active force behind the wall,
- Coefficient of sliding,  $\tan\phi$ ,
- Seismic design parameters:
  - Peak ground acceleration coefficient (PGA)
  - Short period spectral acceleration coefficient ( $S_s$ )
  - Long period spectral acceleration coefficient ( $S_l$ )
  - Site class
  - Peak ground acceleration coefficient modified by the zero period site factor ( $A_s$ )
  - Horizontal seismic acceleration coefficient ( $k_h$ )
  - Seismic active pressure coefficient ( $K_{AE}$ ) – where Mononobe-Okabe method is suitable
  - Dynamic active horizontal thrust, including static earth pressure ( $P_{AE}$ ) – where Mononobe-Okabe method is not suitable
- Separate earth pressure diagrams for strength and extreme event (seismic) limit state calculations that include all applicable earth pressures, with the exception of traffic barrier impact loads (traffic barrier impact loads are developed by the structural designer).

The geotechnical designer evaluates the overall stability. If overall stability controls the required wall width, the designer provides the minimum footing or reinforcement length required to

maintain an acceptable safety factor (1.5 for the strength and 1.1 for the extreme event limit states, which is the inverse of the resistance factor, i.e., 0.65 and 0.9, respectively).

Figure 20-4 Example of bearing resistance recommendations for gravity walls

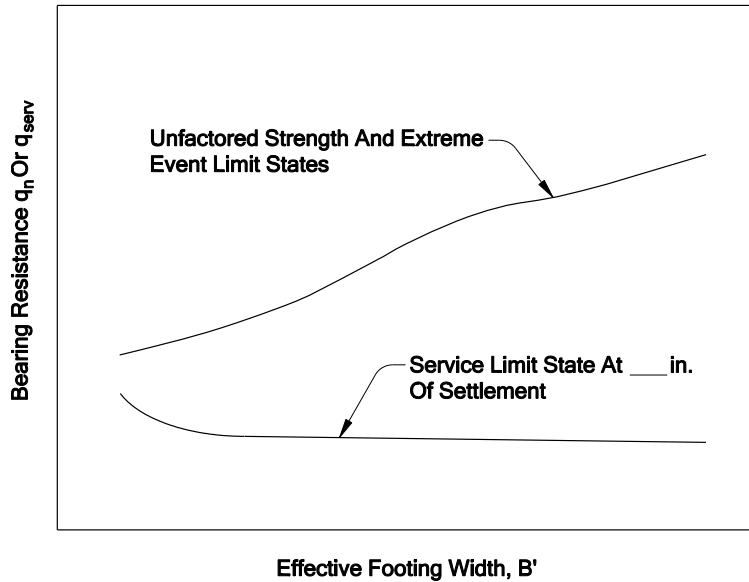
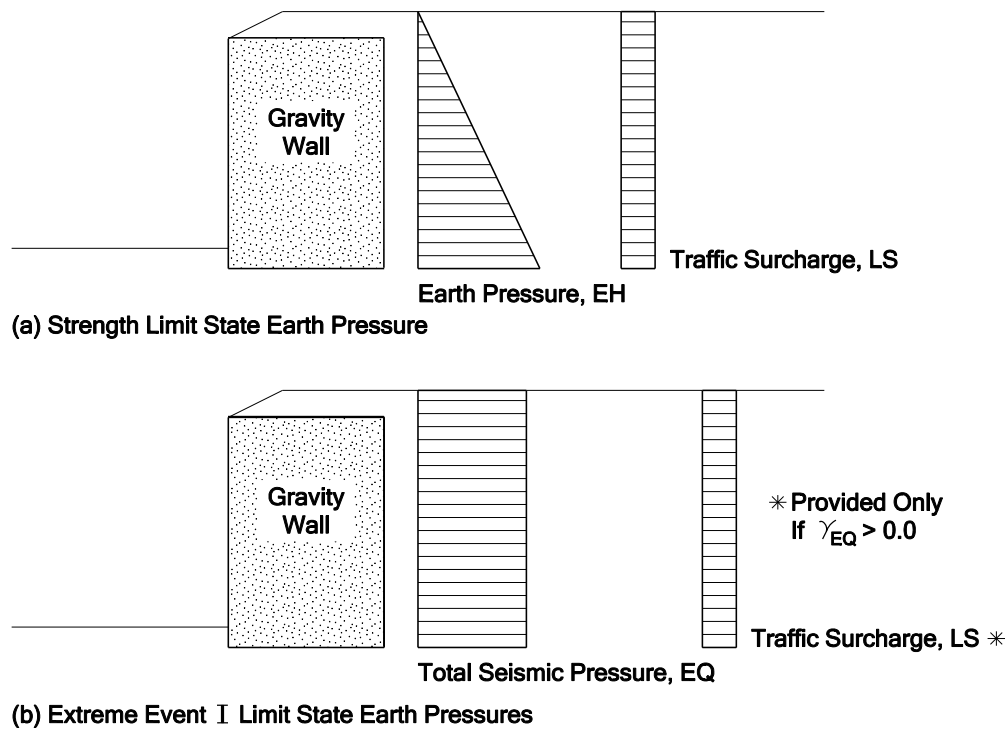

Figure 20-5 Example of lateral earth pressures for gravity wall design



For non-proprietary MSE walls, the spacing, strength, and length of soil reinforcement is provided, as well as the applicable resistance factors. MSE reinforcement properties are specified in the special provisions for *Section 02320*. Spacing and length requirements may also be best illustrated using typical cross sections.

For non-gravity cantilever walls and anchored walls, the following are provided:

- Bearing resistance of the soldier piles or drilled shafts as a function of depth (see Figure 20-3),
- Lateral earth pressure distribution (active and passive),
- Minimum embedment depth required for overall stability,
- No load zone dimensions,
- Anchor resistance for anchored walls, and the associated resistance factors.

Table 20-8 and Figure 20-6 provides an example presentation of soil design parameters and earth pressure diagrams for non-gravity cantilever and anchored walls to be provided by the geotechnical designer.

**Table 20-8 Example presentation of soil design parameters for design of non-gravity cantilever walls and anchored walls.**

<b>Parameter</b>	<b>Value</b>
Soil Unit Weight, $\gamma$ (all applicable strata)	x
Soil Friction Angle, $\Phi$ (all applicable strata)	x
Active Earth Pressure Coefficient, $K_a$	x
Passive Earth Pressure Coefficient, $K_p$	x
Seismic Earth Pressure Coefficient, $K_{ae}$	x
Averaged $\gamma$ used to determine $K_{ae}$	x
Averaged $\Phi$ used to determine $K_{ae}$	x

Figure 20-6 Example presentation of lateral earth pressures for non-gravity cantilever and anchored wall design.

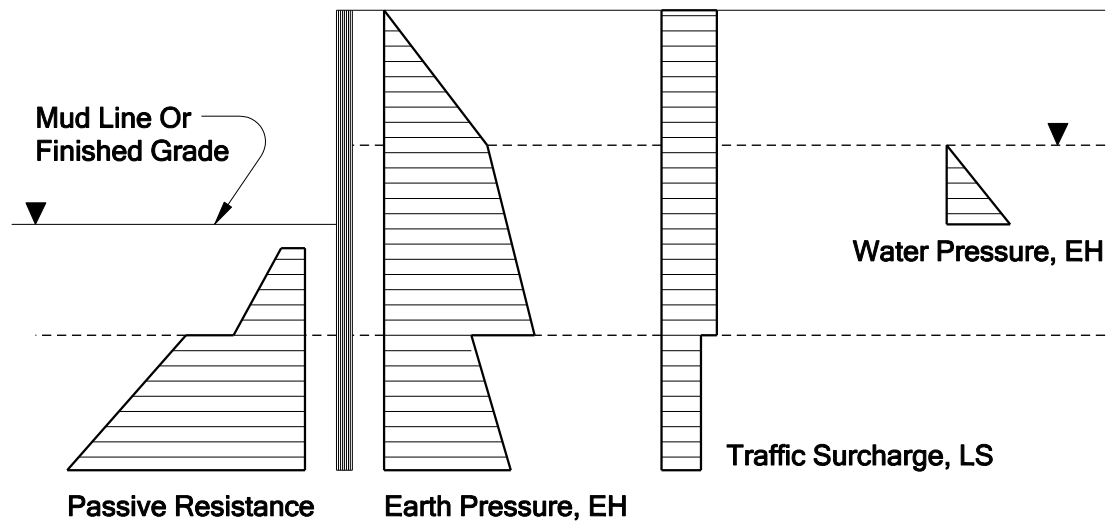

(a) Strength Limit State Earth Pressures

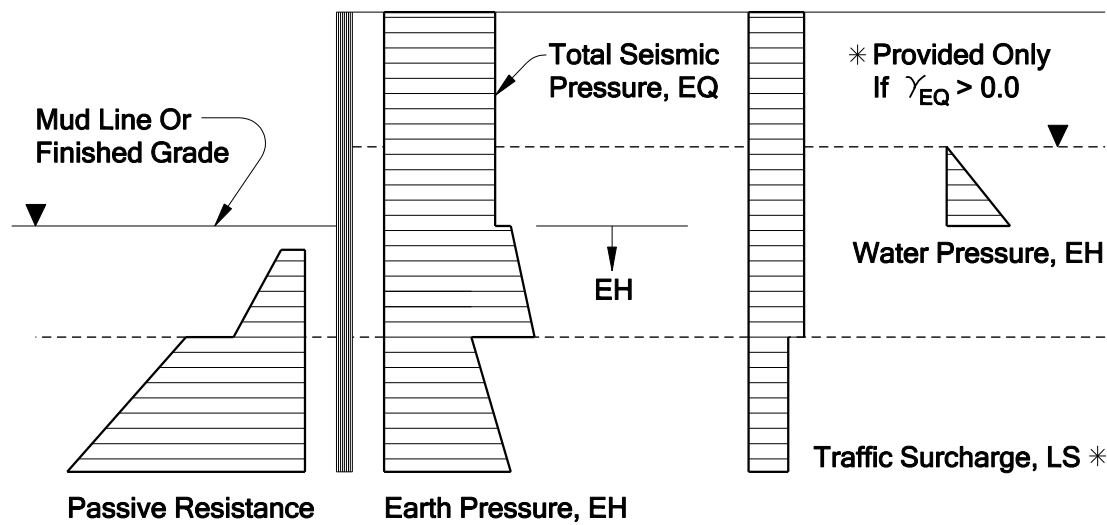

(b) Extreme Event I Limit State Earth Pressures

## 20.7 Geotechnical Design File Information

Documentation that provides details of the basis of recommendations made in the geotechnical report or memorandum is critical not only for review by senior staff, but also for addressing future questions that may come up regarding the basis of the design, to address changes that may occur after the design is completed, to address questions regarding the design during construction, to address problems or claims, and for important information for developing future projects in the same location, such as bridge or fill widening. Since the engineer who

does the original design may not necessarily be the one who deals with any of these future activities, the documentation must be clear and concise, and easy and logical to follow. Anyone who must look at the calculations and related documentation should not have to go to the original designer to understand **the calculations being performed**.

The project documentation must be consistent with FHWA guidelines and as set forth in this chapter. Details regarding what this project documentation should contain are provided in the following sections.

## **20.7.1 Documentation for Preliminary Geotechnical Design**

Document sources of information (including the date) used for the preliminary evaluation. Typical sources include as-built bridge or other structure drawings, as-constructed roadway drawings, existing test hole logs, geologic maps, previous or current geologic reconnaissance results or previous site investigation work and instrumentation data. Also document the following:

- The details of **the geologic reconnaissance** site visit, including any photos.
- Provide a description of the foundation support used for the existing structure, including design bearing capacity, if known, and any foundation capacity records such as pile driving logs, load test results, etc.
- From the contract or maintenance records, summarize any known construction or maintenance problems encountered during construction or throughout the life of the structure. Examples from the construction records include over-excavation depth and extent, and why it was needed, seepage observed in cuts and excavations, dewatering problems, difficult digging, including obstructions encountered during excavation, obstructions encountered during foundation installation (e.g., for piles or shafts), slope instability during construction, changed conditions or change orders involving the geotechnical features of the project, and anything else that would affect the geotechnical aspects of the project.
- For any geotechnical recommendations made, summarize the logic and justification for those recommendations. If the recommendations are based on geotechnical engineering experience and judgment, describe what specific information led to the recommendation(s) made.

## **20.7.2 Documentation for Final Geotechnical Design**

In addition to the information described above in [Section 20.7.1](#), the following information is documented and maintained in the project geotechnical file:

1. List or describe all given information and assumptions used, as well as the source of that information. For all calculations, an idealized design cross-section that shows the design

element (e.g., wall, footing, pile foundation, buttress, rock slope, etc.) located in context to the existing and proposed ground lines, and the foundation soil/rock is provided. This idealized cross-section shows the soil/rock properties used for design, the soil/rock layer descriptions and thicknesses, the water table location, the existing and proposed ground line, and any other pertinent information. For slope stability, the soil/rock properties used for the design is shown on the computer generated output cross-section.

2. Additional information and/or a narrative is provided which describes the basis for the design soil/rock properties used. If the properties are from laboratory tests, state where the test results, and the analysis of those test results, can be found in the final geotechnical design documentation and how those test results apply to the specific site conditions and strata encountered including consideration of site geological history. If using correlations to SPT, cone data or other measurements, state which correlations were used, the range of applicability of the correlation to the available measurements, the potential uncertainty in the estimated property value due to the use of that correlation and any corrections to the data made,
3. The design method(s) used must also be clearly identified for each set of calculations, including any assumptions used to simplify the calculations, if that was done, or to determine input values for variables in the design equation. Write down equation(s) used and the meaning of the terms used in equation(s), or reference where equation(s) used and/or meaning of terms were obtained. Attach a copy of all curves or tables used in making the calculations and their source, or appropriately reference those tables or figures. Write down or summarize all steps needed to solve the equations and to obtain the desired solution.
4. If using computer spreadsheets, provide detailed calculations for one example to demonstrate the basis of the spreadsheet and that the spreadsheet is providing accurate results. Hand calculations are not required for well proven, well documented programs such as XSTABL, SLOPE/W, SHAKE2000 or GRLWEAP. Detailed example calculations that illustrate the basis of the spreadsheet are important for engineering review purposes and for future reference if someone needs to get into the calculations at some time in the future. A computer spreadsheet in itself is not a substitute for that information.
5. Highlight the solutions that form the basis of the engineering recommendations to be found in the project geotechnical report so that they are easy to find. Be sure to write down which locations or piers where the calculations and their results are applicable.
6. Provide a results summary, including a sketch of the final design, if appropriate.

Each set of calculations (for each structure) is sealed and dated by the professional-of-record. If the designer is not registered, the reviewer initials and dates the calculations. Consecutive page numbers should be provided for each set of calculations and each page should be initialed by the reviewer.

A copy of the appropriate portion of the FHWA checklist for geotechnical reports (i.e., appropriate to the project) is included with the calculations and filled out as appropriate. This

checklist will aid the reviewer regarding what was considered in the design and to help demonstrate consistency with the FHWA guidelines.

### **20.7.3 Geotechnical File Contents**

The geotechnical project file(s) contains the information necessary for future users of the file to understand the historical geotechnical data available and all the geotechnical work that was performed as part of this project. This would include the scope of the project, the dimensions and locations of the project features, the geotechnical investigation plan, field and laboratory testing and results, the geotechnical design work performed and design recommendations.

Two types of project files should be maintained: 1) the geotechnical design file(s), and 2) the construction support file(s).

The geotechnical design file specifically contains the following information:

- Historical project geotechnical;
- As-built data and historical geotechnical information related to, the project;
- Geotechnical investigation plan development documents;
- Geologic reconnaissance results;
- Cross-sections, structure layouts, etc., that demonstrate the scope of the project and project feature geometry as understood at the time of the final design, if such data is not contained in the geotechnical report;
- Information that illustrates design constraints, such as right-of-way location, location of critical utilities, wetlands and location and type of adjacent facilities that could be affected by the design;
- Boring log field notes;
- Boring logs;
- Field test results, (CPT, pressure meter, vane shear, shear wave measurements);
- Laboratory test results, including rock core photos and records;
- Field instrumentation measurements;
- Final calculations only, unless preliminary calculations are needed to show design development;
- Final wave equation runs for pile foundation constructability evaluation;
- Key photos (must be identified as to the subject and locations), including CD with photo files;
- Key correspondence (including e-mail) that tracks the development of the project and contains information regarding design changes or geotechnical recommendations. This does not include general correspondence that is focused on project coordination activities.

The geotechnical construction file contains the following information (as applicable):

- Pile hammer approval letter with driving criteria including wave equation analysis;
- Construction submittal reviews (retain temporarily only, until it is clear that there will be no construction claims);

- PDA/CAPWAP results;
- Embankment or other instrumentation monitoring data;
- Change order correspondence and calculations;
- Documentation of any changes to the original geotechnical design or specifications;
- Claims-related correspondence and data;
- Photos (must be identified as to the subject and locations), including electronic storage with photo files;
- CSL reports and any correspondence concerning shaft defects, repair work and the approval of drilled shafts.

### **20.7.3.1 Consultant Geotechnical Reports and Documents Produced For ODOT**

Geotechnical reports and documents produced by geotechnical consultants (including geotechnical work performed for Design-Build projects) shall be subject to the same reporting and documentation requirements as those produced by ODOT staff, as described in this chapter. The detailed analyses and/or calculations produced by the consultant in support of the geotechnical report development shall be provided to ODOT.

## **20.8 References**

Section intentionally blank.



# Appendix 20-A Geotechnical Report Review Checklist

(Structure Foundations Supplement)

YES	NO	N/A	
			<b>1 Title/Cover Page</b>
			1.1 Heading "Geotechnical Report" in larger letters
			1.2 Bridge Name
			1.3 Bridge Number
			1.4 Section Name
			1.5 Highway & Milepoint
			1.6 County
			1.7 Key Number
			1.8 Date
			<b>2 Table of Contents</b>
			<b>3 Detailed Vicinity Map</b>
			<b>4 Body of Report</b>
			4.1 Introduction
			4.1.1. Is project scope and purpose summarized?
			4.1.2 Is a concise description given for the general geologic setting and topography of the area?
			4.2 Office Research
			4.2.1 Summary of all pertinent records and other information that relate to foundation design and construction.
			4.3 Subsurface Explorations and Conditions
			4.3.1 Is a summary of the field explorations, locations, and testing given?
			4.3.2 Is a description of general subsurface soil and rock conditions given?
			4.3.3 Is the groundwater condition given?
			4.4 Laboratory Data
			4.4.1 Are laboratory test results (e.g., natural moisture, Atterberg Limits, consolidation, shear strengths, etc.) discussed and summarized in the report?
			4.5 Summarize Hydraulics Information that affects foundation recommendations
			4.5.1 Bridge options providing required waterway
			4.5.2. 100 and 500-year scour depths and elevations
			4.5.3. Riprap protection; class, depth, and extent
			4.6 Seismic Analysis and Evaluation
			4.6.1 Bedrock acceleration coefficients (500 & 1000-yr) and AASHTO soil profile type
			4.6.2 Liquefaction analysis and bridge access & performance assessment (settlement, stability, lateral deformation)
			4.6.3 Liquefaction Mitigation recommended?
			4.6.3.1. Mitigation design, specifications and cost estimates supplied?
			4.7 Foundation Analyses and Design Recommendations
			4.7.1 Foundation Options and Discussion
			4.7.2 Pile Foundations
			4.7.2.1. Type (steel pipe, H-pile, concrete, displacement/friction or end-bearing)
			4.7.2.2. Material specification (e.g., ASTM & steel grade), size (e.g., O.D. and thickness)
			4.7.2.3. Tip treatment; open or closed-ended, tip protection required
			4.7.2.4. Ultimate nominal resistance, estimated cutoff elevation, estimated tip elevation. "estimated" or "order" length and minimum required tip elevation.
			4.7.2.5. Axial factored resistance and resistance factor
			4.7.2.6. Nominal and factored uplift resistances
			4.7.2.7. Lateral resistance
			4.7.2.6.1. Soil parameters for LPILE or COM624P analysis (e.g., p-y data, liquefied & nonliquefied soil conditions)
			4.7.2.8. Pile group settlement addressed?
			4.7.2.9. Downdrag potential addressed?
			4.7.2.8.1. Provide downdrag loads, load factors and discussion of how downdrag loads are accounted for or mitigated?
			4.7.2.10. Reduced pile resistances (axial, uplift, lateral, etc) as a result of liquefaction, scour or downdrag
			4.7.2.11. Driving Criteria and Driveability Analysis
			4.7.2.10.1. Dynamic equation where driveability or driving stress problems are not expected
			4.7.2.10.2. Wave Equation for nominal resistances greater than 540 kips or expected driving stress problems.
			4.7.2.12. Static or dynamic load testing
			4.7.2.11.1 Are specifications provided describing how the tests are conducted and clearly defining all responsibilities?
			4.7.3. Drilled Shafts
			4.7.3.1. Shaft type (i.e., end-bearing, friction or combination)
			4.7.3.2. Nominal axial resistance provided for various diameters and lengths (depths or tip elevs.)
			4.7.3.3. Rock socket lengths specified (and/or shaft tip elevations)
			4.7.3.4. Estimates of shaft settlement with depth under unfactored (service) load conditions.
			4.7.3.5. Resistance factors and factored resistances.
			4.7.3.6. Shaft group effects addressed?
			4.7.3.7 Lateral capacity addressed?
			4.7.3.7.1. Soil parameters for COM624P or LPILE analysis provided (e.g., p-y data, liquefied & nonliquefied soil conditions)
			4.7.3.8 Static or dynamic load testing required?
			4.7.3.8.1 Are specifications provided describing how the tests are conducted and clearly defining all responsibilities?
			4.7.4. Spread Footings
			4.7.4.1. Description and properties of the anticipated foundation soil or rock
			4.7.4.2. Nominal bearing resistance as function of effective footing width
			4.7.4.3. Nominal bearing resistance for a given settlement (service limit state)
			4.7.4.4 Resistance factors and factored bearing resistance for strength and extreme limit states
			4.7.4.5. Recommended maximum elevation for base of footing
			4.7.4.6. Soil parameters for sliding and eccentricity provided?
			4.7.4.7. Overall stability checked?



**ODOT provides a safe and reliable multimodal transportation system that connects people and helps Oregon's communities and economy thrive.**

[www.oregon.gov/ODOT](http://www.oregon.gov/ODOT)

