

Chapter 11

Contents

11 Temporary Signal Plan 11-1

11.1 General..... 11-1

11.2 When is a Temporary Signal Needed?..... 11-1

11.3 Operational Approval of Temporary Signals 11-3

11.4 Design Approval of Temporary Signals 11-10

11.5 Using Existing or New Signal Equipment as Part of the Temp. Installation..... 11-10

11.6 Temporary Signal Design 11-11

 11.6.1 Poles 11-11

 11.6.2 Controller Cabinet..... 11-13

 11.6.3 Service Cabinet and Meter Base 11-13

 11.6.4 Junction Boxes..... 11-14

 11.6.5 Use of Detection (Vehicle, Bicycle, Pushbuttons, & Preemption Detectors)..... 11-14

 11.6.6 Vehicle Detection..... 11-17

 11.6.7 Wiring 11-17

 11.6.8 Staging 11-20

11.7 Temporary Bridge Signal Design..... 11-31

 11.7.1 Phasing..... 11-31

 11.7.2 Sight Distance 11-32

 11.7.3 Stop Line Location..... 11-34

 11.7.4 Signal Head Alignment..... 11-35

 11.7.5 Vehicle Detection..... 11-36

 11.7.6 Bicycle Detection 11-37

11.8 Portable Temporary Traffic Signal 11-38

11.9 Standard Drawings and Specifications Applicable to Temporary Signals..... 11-38

11 Temporary Signal Plan

11.1 General

Temporary signals are intended to be used for long-term stationary temporary traffic control zones, yet their appearance, design and operation are held to the same standards as permanent signals. Drivers expect the same meaning from temporary traffic signals as they do from permanent traffic signals, so the signal design and operation shall meet all applicable MUTCD and ODOT standards. The design procedure for a temporary signal shall follow the same standards and guidelines that would be used for a permanent signal.

The [ODOT Traffic Control Plans Design Manual](#), should be consulted for additional information on the use of temporary traffic signals.

11.2 When is a Temporary Signal Needed?

There are two typical design categories that most temporary signals will fit into: temporary bridge signals and temporary signals for modification or replacement of an existing signal.

Temporary signals are required in the following circumstances:

- For construction staging that requires one-lane, two-way traffic AND where use of 24/7 flagging would be cost prohibitive. Either a standard temporary bridge signal or a portable temporary traffic signal could be used for this application.
- When the new signal can't be built without impacting the existing signal.
- When re-building an existing signal that requires staged construction (where lane use and/or signal phasing will be modified based on each stage)
- When the temporary re-alignment or modification of the signal heads at an existing signal is needed to accommodate traffic during the construction of a project in the vicinity of the traffic signal.
- When adjustment to the existing pushbutton locations is required to accommodate temporary pedestrian accessibility routing (TPAR)

In some cases, re-building an existing signal can be accomplished without a temporary signal if the existing intersection geometry doesn't change (or changes very little) and placement of the new signal equipment is carefully considered (especially poles, conduit, and junction boxes). If possible, place the new poles behind the existing poles so that construction of the new mast arm does not block the existing signal heads. See Figure 11-1 for examples of signal heads being obstructed during construction. If a new signal pole must be placed in front of an existing signal pole, there is an opportunity to save the expense of a temporary signal by requiring that the new mast arm be installed on the day of the signal turn-on. However, to allow for an efficient and successful signal turn-on, only one signal mast arm per intersection may be allowed to be installed at the day of turn on. See Figure 11-2.

Traffic Signal Design Manual – Temporary Signal Plan

Rebuilding an existing traffic signal without a temporary signal is preferred as it saves the throw-away expense of a temporary signal (cost of design, construction, and potentially right-of-way). However, it often requires the contractor to be more careful (e.g., more labor/longer construction time) when installing the new signal equipment to avoid damaging the existing signal equipment before it can be removed. In these cases, engineering judgement should be used to weigh the pros and cons to decide if a temporary signal will result in a more successful installation and better final product.

Figure 11-1 | Obstructing Signal Heads During Construction

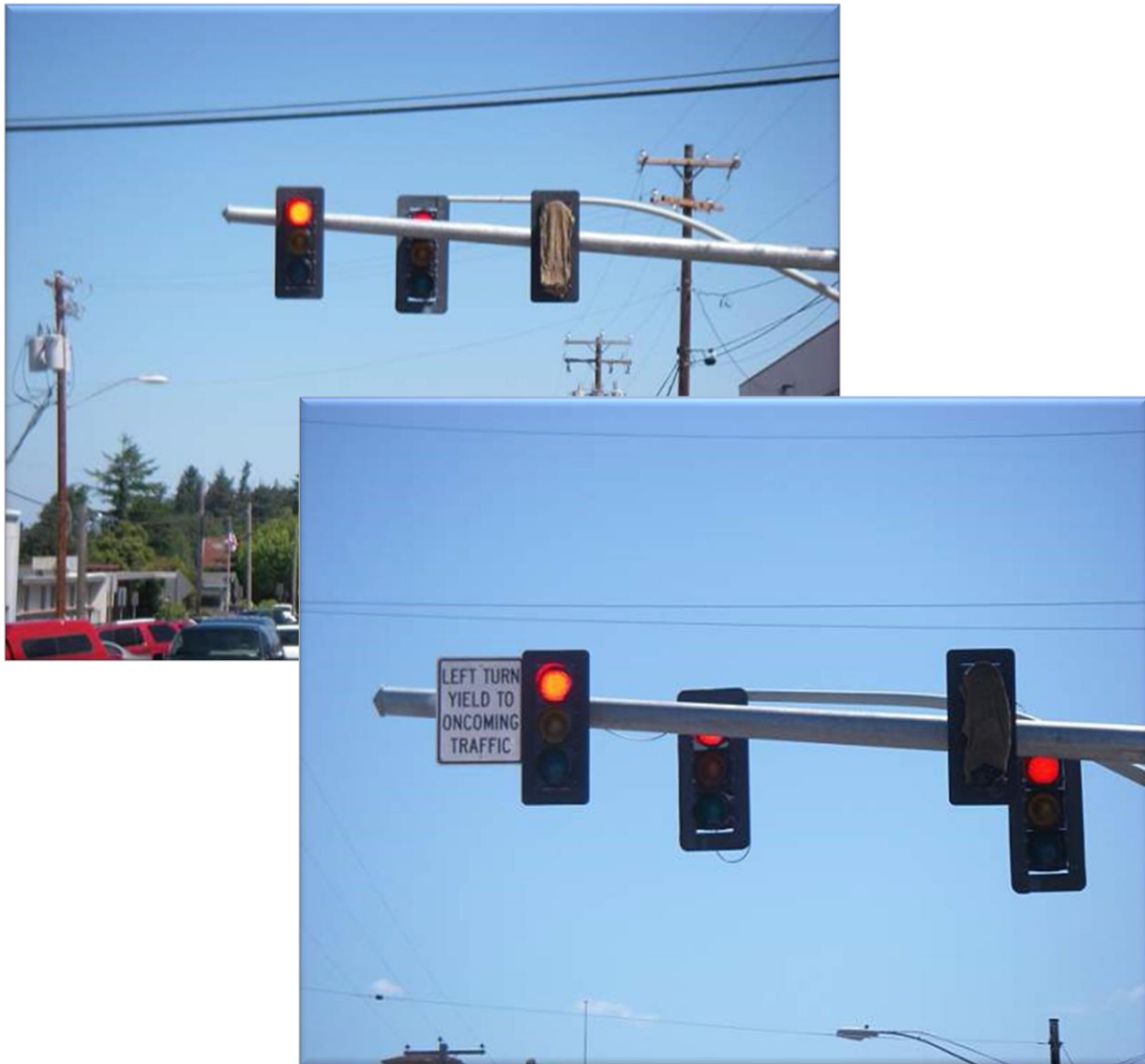
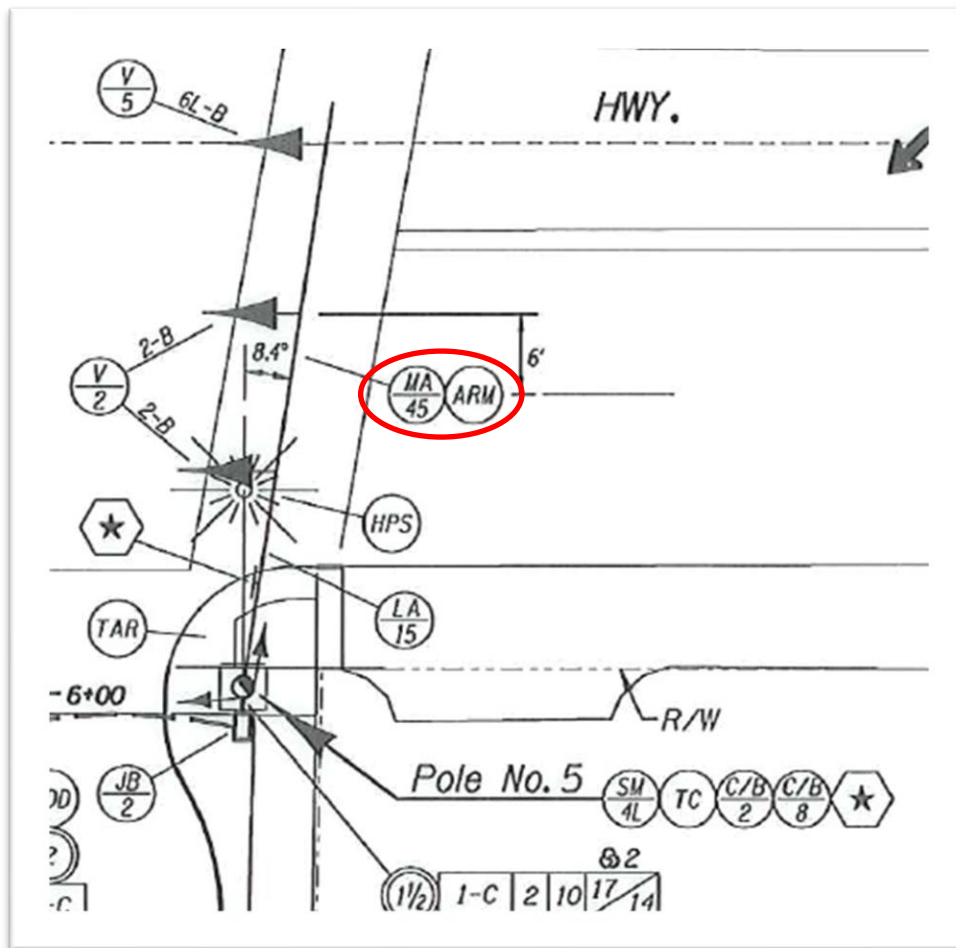

Figure 11-2 | Installing Mast Arm the Day of Signal Turn-On



(ARM) Install traffic signal mast arm on day of signal turn-on.

11.3 Operational Approval of Temporary Signals

The following temporary traffic signal applications require STE operational approval (see chapter 3 for more information on operational approvals):

- Portable temporary traffic signals
- Temporary bridge signals (one-lane, two-way operation)
- Temporary signals located at intersections that are not currently under signalized control (e.g., detours that require re-routing large volumes of traffic to existing unsignalized intersections)
- Temporary closure of crosswalks at signalized intersections

Temporary signals installed at the same location with the same operations that mimic an existing signal or mimic the proposed STE approved new signal do NOT require STE or RTE operational approval.

The following temporary traffic signal application requires RTE operational approval (see chapter 3 for more information on operational approvals):

- Stage construction that is significantly different (geometry, lane use, and/or operation) than the existing traffic signal or the approved new traffic signal.

Determining if the geometry and operation is significantly different from the existing or approved signal operations can be a grey area. The main reasons for requiring an operational approval for a temporary signal needed for stage construction is to determine if the operation is safe, meets driver expectation, and will not be detrimental to maintaining traffic flow.

If the temporary signal operational/geometric changes are minor and incrementally made over the course of construction, additional operational analysis beyond what is required for the permanent signal is typically not needed to ensure the temporary signal staging is appropriate. See Figure 11-3. This case study shows a project going from existing conditions to the permanent signal installation where the temporary traffic signals for each stage do NOT require an operational approval.

However, significantly different operations or geometry (especially if the signal will be operating in a coordinated system) typically require a more in-depth analysis to ensure that temporary signal will operate appropriately. See Figure 11-4. This case study shows a project going from existing conditions to permanent signal installation where three of the temporary traffic control stages result in significant lane use and/or operational changes that do require additional operational approval(s) for the temporary staging. The types of changes shown require an RTE operational approval.

If there is a question as to whether a temporary traffic signal requires an operational approval, contact the state traffic operations engineer. When in doubt, err on the side of caution and submit a request for a STE operational approval.

Traffic Signal Design Manual – Temporary Signal Plan

Figure 11-3 | Case Study 1 – Operational Approval NOT Required for Temporary Signal Staging (Continued on Next Page)

Existing conditions: The existing lane use is a 5-lane section on the mainline, with a right turn only from the top approach and one-way on the bottom approach. Three crosswalks are currently marked. The existing intersection operates as stop control on the side-street and free-flow on the mainline. This intersection has an STE operational approval for a new, permanent traffic signal.



Stage 3: The existing lane use on the top approach has changed from a right turn only to a right-thru-left turn lane, matching the STE approved permanent lane configuration for that approach. The existing marked crosswalks remain the same. The existing intersection operation has changed from stop control to signalized, with the signal phasing very closely matching the STE approved operation.

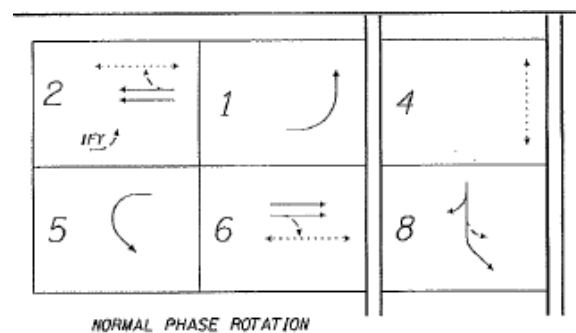
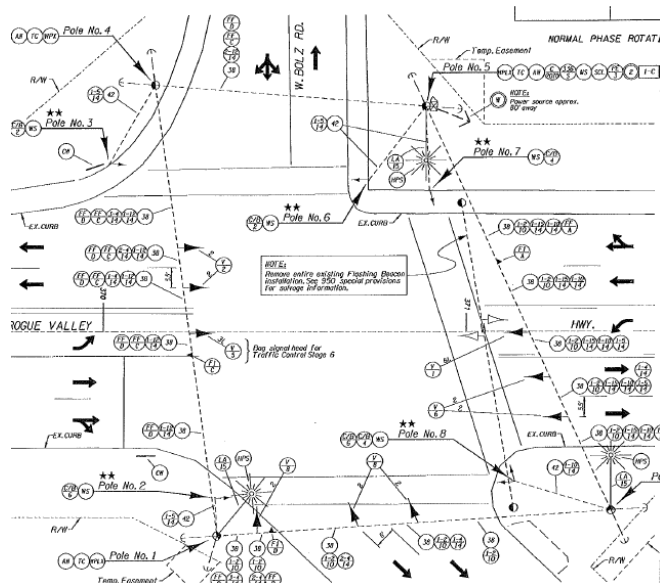
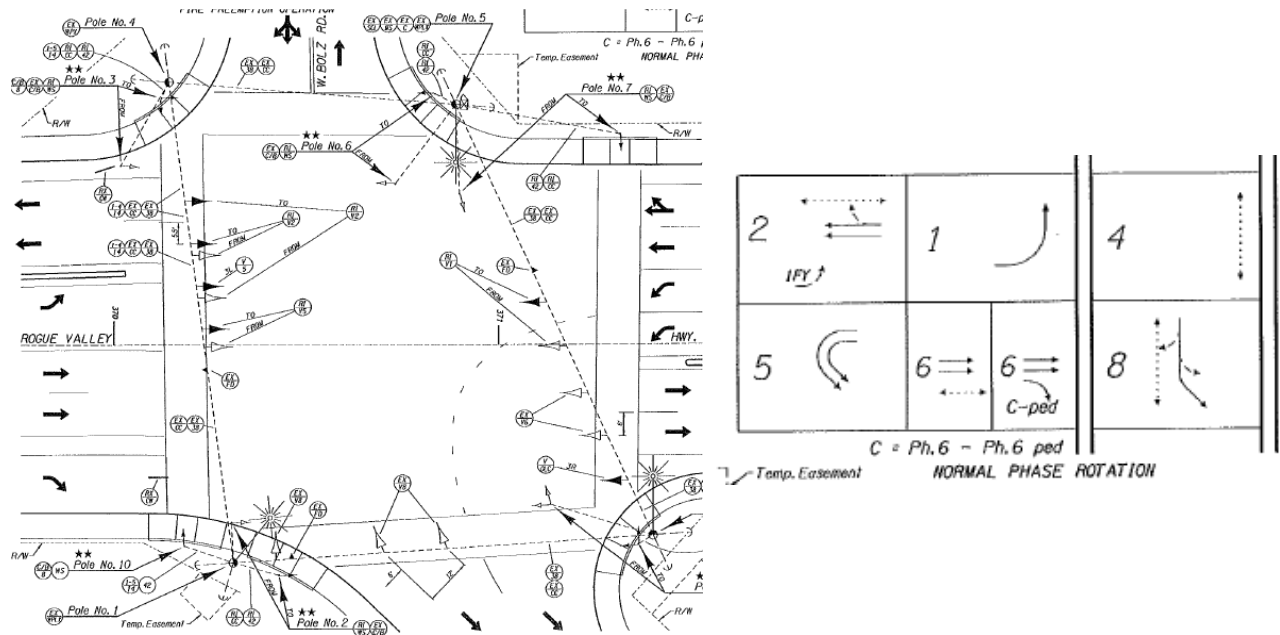

Figure 11-3 continued on next page.

Traffic Signal Design Manual – Temporary Signal Plan

Stage 7: The lane use from stage 3 has changed from a thru-right lane to the addition of right turn only lane on the left approach and from a single left turn lane to a dual left turn lane on the right approach, matching the STE approved permanent lane configuration. All four crosswalks are now open. The operation from stage 3 has changed to allow a not-ped overlap phase for the new right turn only lane, matching the STE approved permanent signal operation.



Permanent Traffic Signal: STE approved permanent signal design and operation.

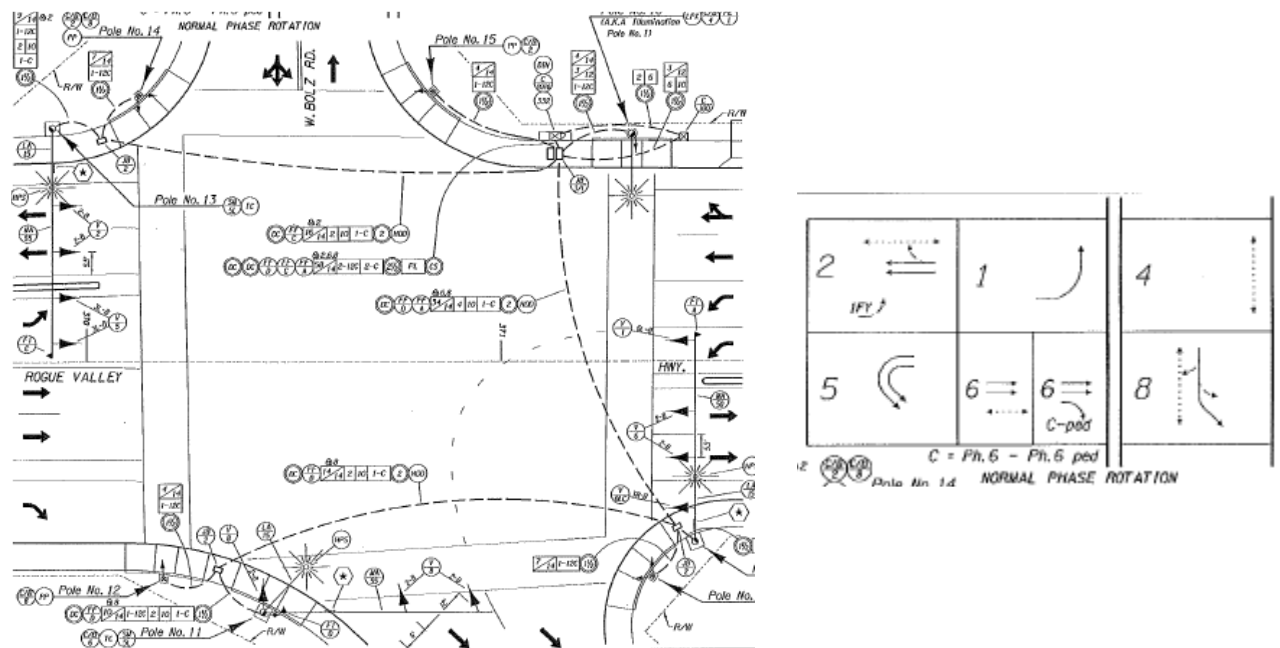

Traffic Signal Design Manual – Temporary Signal Plan

Figure 11-4 | Case Study 2 – Operational Approval Required for Temporary Signal Staging
(Continued on Next Two Pages)

Existing conditions: The existing lane use is a 4-lane section on the mainline. The top approach is a freeway off-ramp and the bottom approach is a freeway on-ramp. Three crosswalks are currently marked. The existing intersection operates with PPLT phasing on the highway. This intersection has an STE operational approval for a new, permanent traffic signal.



Stage 1, Phase 2 (RTE operational approval required): The existing intersection geometry has significantly changed, with the top approach moving towards the right almost creating two separate intersections. Two of the existing crosswalks are now closed. This new geometry will require more red clearance time to clear vehicles. Because the geometry and operation of this intersection is significantly different from the existing and STE approved permanent traffic geometry, this stage requires RTE approval. Note that the temporary crosswalk closures require STE operational approval.

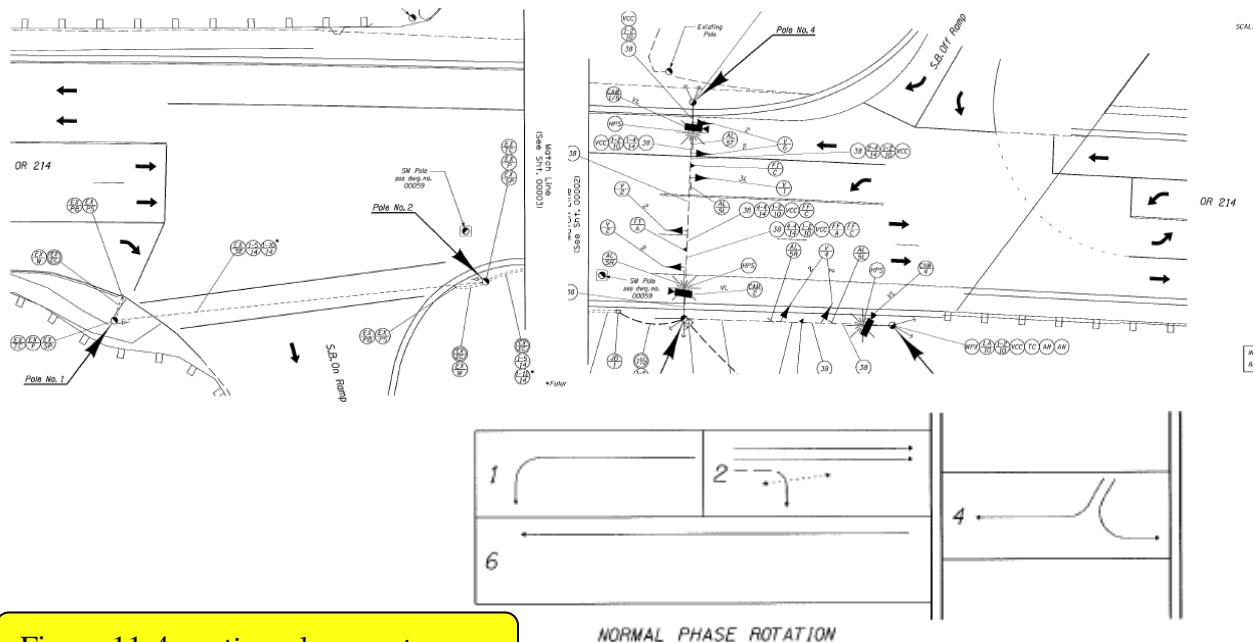
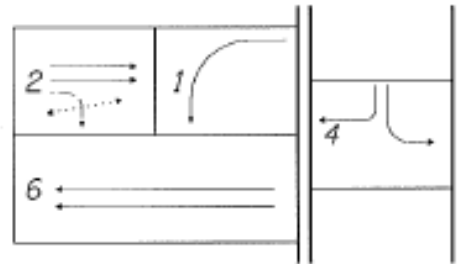
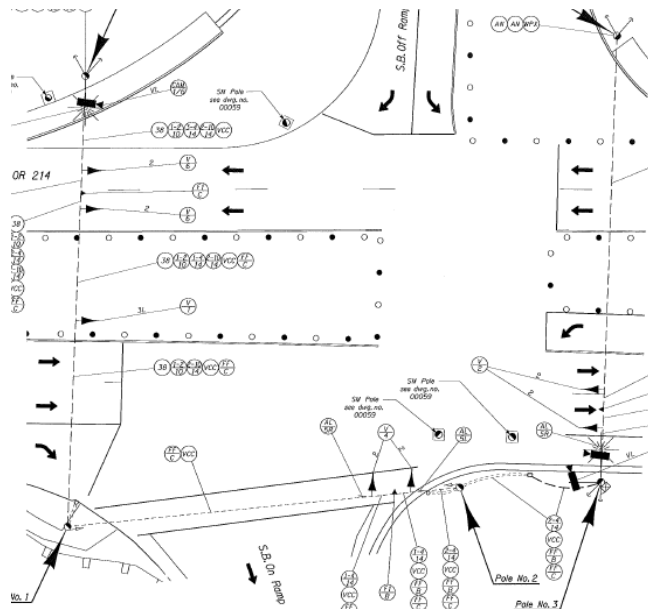

Figure 11-4 continued on next page.

Traffic Signal Design Manual – Temporary Signal Plan

Stage 2, Phase 1 (RTE operational approval NOT required): The lane use from Stage 1, Phase 1 has shifted the top approach alignment back much closer to the original existing location. The crosswalk closures remain the same. Operation changes from the previous stage are minimal. This stage does NOT require RTE approval due to similarities of the existing conditions and previous stage RTE approval.



NORMAL PHASE ROTATION

Stage 2, Phase 2 (RTE operational approval required): The lane use from Stage 2, Phase 1 has changed significantly, with the top approach now containing the on-ramp for the freeway. All four crosswalks are now closed. Operation changes from the previous stage are significantly different and do not match the STE approved permanent traffic geometry/operations. This stage requires RTE approval. Note that the temporary crosswalk closure here requires STE operational approval.

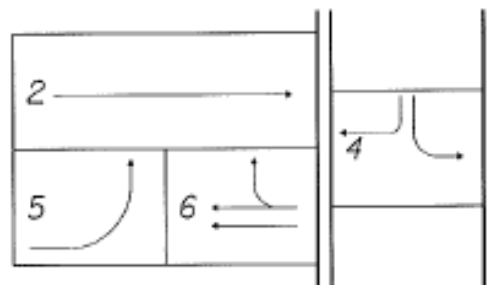
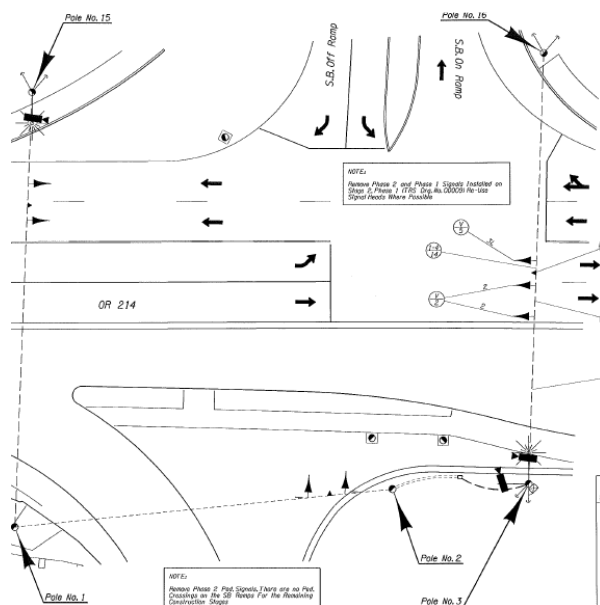

NORMAL PHASE ROTATION

Figure 11-4 continued on next page.

Traffic Signal Design Manual – Temporary Signal Plan

Stage 3, phase 1 (RTE operational approval required): The lane use from Stage 2, Phase 2 has now changed to closely match the STE approved permanent geometry. However, the unusual lane use for the top approach (where the right turn movement is divided – one is free flow and one is controlled by the signal in a left-right lane) warrants documentation. **All four crosswalks remain closed.** Operation changes from previous stage are significantly different and now closely match the STE approved permanent operations (minus the top approach right turn overlap and pedestrian phases). This stage requires RTE approval.

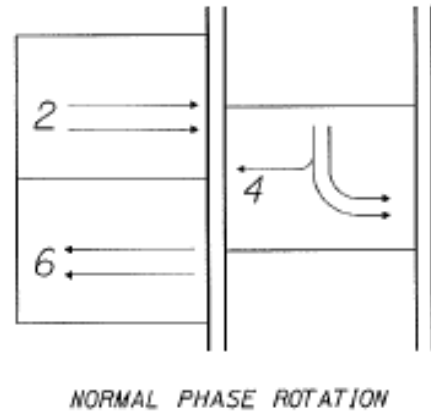
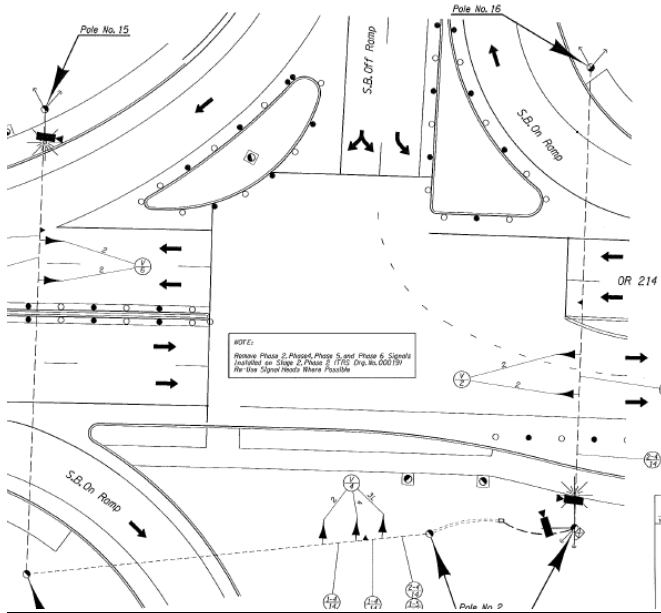

Permanent Traffic Signal: STE approved permanent signal design and operation.

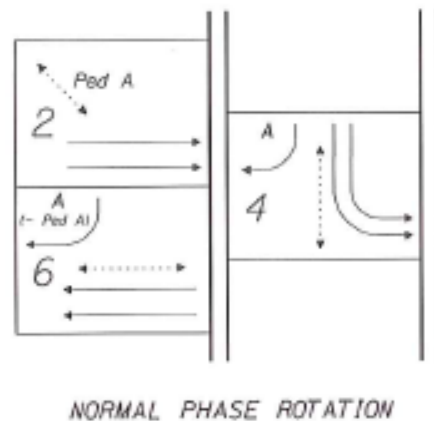
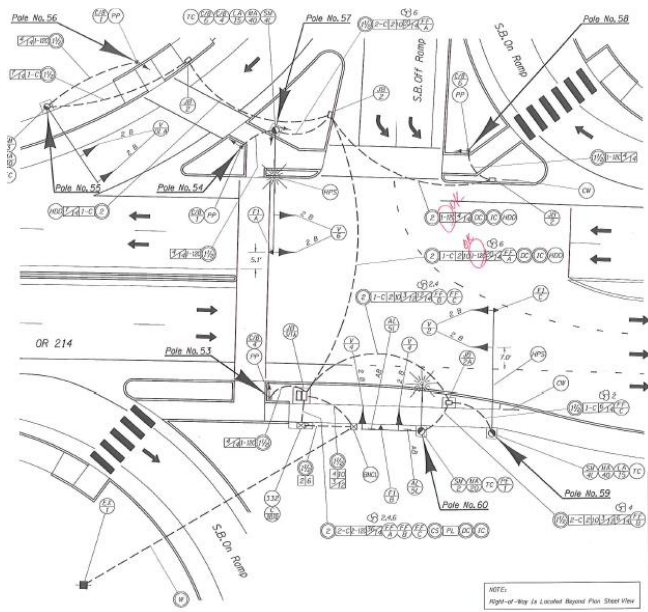

11.4 Design Approval of Temporary Signals

All temporary traffic signals, **except** portable temporary traffic signals, require design approval (see chapter 2 for more information on design approval).

11.5 Using Existing or New Signal Equipment as Part of the Temp. Installation

The practice of using existing or new signal equipment as part of a temporary signal is not allowed, for the following reasons:

- It complicates the contract administration of project (payment issues)
- The responsible party for maintenance of the equipment becomes confusing (per specifications: maintenance of temporary installations is the responsibility of the contractor and maintenance of the permanent signal after turn-on is the responsibility of the agency)
- Equipment most likely will have to be modified or wired in a non-standard way to incorporate the permanent or existing equipment into the temporary installation.
- There is a high risk of damage to the new equipment.

See Figure 11-5 showing an example of the undesirable non-standard wiring when using new equipment for a temporary installation.

Figure 11-5 | Use of New Equipment for a Temporary Installation – This Practice Not Allowed



Do NOT mix existing or new signal equipment with temporary signal installations (including conduit, junction boxes, and wiring).

11.6 Temporary Signal Design

Temporary signal design should follow the same design guidelines that are contained in the permanent signal design chapters of this manual. This section discusses design information specific to temporary signals including deviations from permanent design (e.g., use of different materials/equipment).

11.6.1 Poles

Wood poles with span wire are used for all temporary installations as per standard specification section 00227. Wood poles are considered non-standard (designated as “X” poles, due to the drafting bubble note nomenclature used to define a non-standard pole). It is the contractor’s responsibility to submit the wood pole certifications and calculations for review and approval before construction begins. The EOR or the traffic structures engineer will approve the submittal.

A span wire pole entrance chart is required to detail all temporary signal poles. See chapter 9 for more information on the pole entrance chart. The only column in the pole entrance chart that doesn’t apply to wood poles is the “Foundation Information” column which should either be deleted or left blank. All other columns should be filled out as applicable to the temporary signal design.

Temporary signals will require modeling of the signal pole, span wires and signal heads that are proposed to pass over the roadway cross section to determine the messenger cable attachment height (MAH) value. See Chapter 9 for how to calculate the MAH. The bottom of the signal heads must not be below 18 feet or above 19 feet during any phase or stage of construction.

The lateral placement of temporary signal poles next to new or existing appurtenances (e.g., existing/new signal poles, cabinets, etc.) should follow the requirements in standard drawing TM653 that are established for embankments. See Figure 11-6. If a temporary pole is placed closer to an object than as shown in the minimum embankment requirements, contact the traffic structures engineer for further analysis.

Figure 11-6 | TM653 Minimum Embankment Requirements

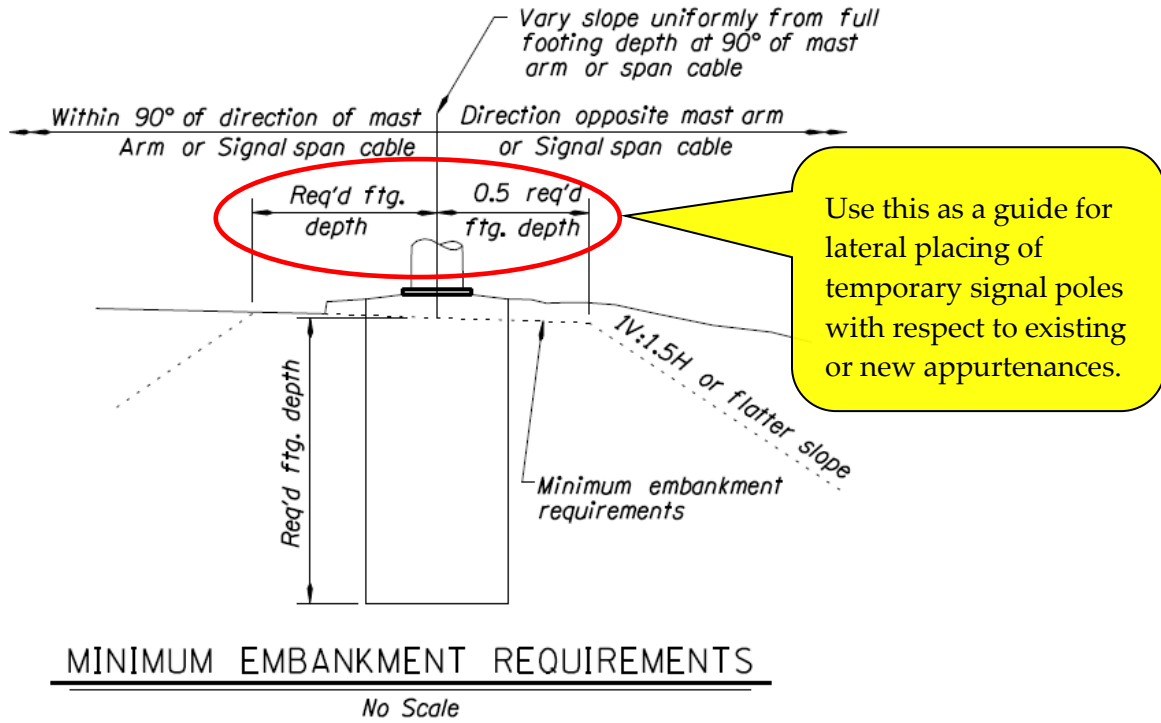

Large poles (those used for span wires) should be set to accommodate all stages of construction. Small posts (for pedestrian indications and pushbuttons) can and should be moved as needed during each stage/phase. Messenger cable going from the large wood strain pole to the small wood posts only needs to be 1/4" (tether cable size) rather than the standard size 3/8" messenger cable due to carrying a significantly reduced load. See Figure 11-7.

Figure 11-7 | Moving Poles During Staging

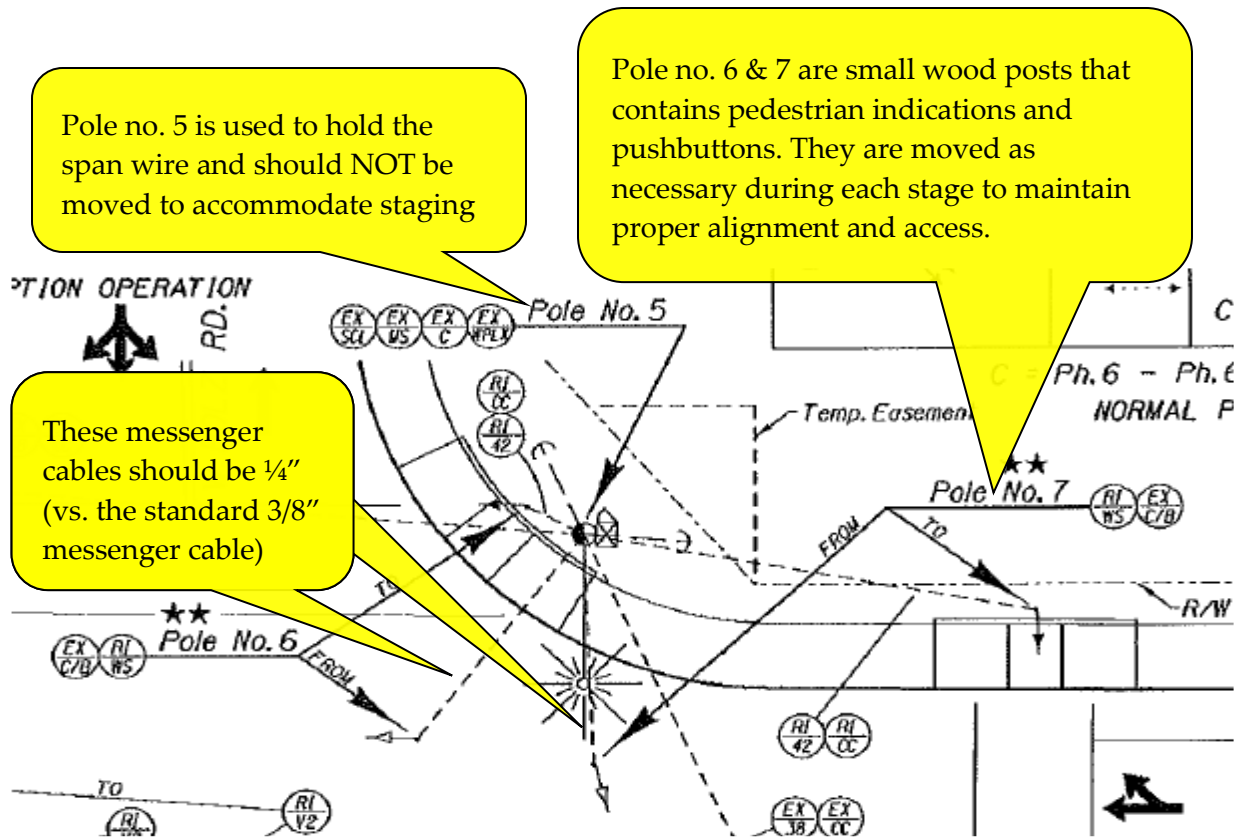

11.6.2 Controller Cabinet

The 332S controller cabinet mounted on a temporary, precast foundation as per TM454 is the standard for all temporary installations.

11.6.3 Service Cabinet and Meter Base

The service and meter base are pole mounted in the same quadrant that controller cabinet is located in. The service cabinet and meter base for temporary installations is shown in the standard drawings.

The connection from the power source to the service cabinet/meter base is typically aerial.

11.6.4 Junction Boxes

Junction boxes used for temporary applications do not require a concrete apron if located in non-paved areas.

11.6.5 Use of Detection (Vehicle, Bicycle, Pushbuttons, & Preemption Detectors)

Equipment such as vehicle detection, pedestrian pushbuttons, and fire preemption detectors should be evaluated according to their need and should not automatically be included in the design. Several factors should be considered when determining whether detection is needed or not:

ALL DETECTION

- Duration of temporary signal – Detection becomes more beneficial and cost effective the longer it is expected to be in service.

VEHICLE DETECTION

- Speed of the mainline – Detection becomes more beneficial if the mainline of the temporary signal is high speed (greater than 35 mph), due to the increased protection of the dilemma zone.
- Traffic volumes – Detection becomes more beneficial if the traffic characteristics of the intersection are highly variable (e.g., heavy directional movements during the AM or PM peak) or if the intersection operates below capacity the majority of the time. When an intersection is operating at or above capacity for all movements, the detection system is less critical because signal will just be “maxing out” all the green time, which is similar to the operation of a fixed time cycle. However, if the intersection is operating at or above capacity for only a few of the movements, using detection for those under capacity movements can improve the flow and queuing of traffic for the movements that are at or above capacity.
- Temporary signal operating in system vs. isolated – Signals operating exclusively in coordinated systems do not use any detection for the coordinated phases (e.g., the mainline thru phases).

BICYCLE DETECTION

- Bicycle lanes & location – Detection is more beneficial on approaches with phases that are not recalled (e.g., side streets).

PEDESTRIAN PUSHBUTTONS

- Accessibility of pedestrian pushbuttons during construction – Pushbutton detection should NOT be used if the construction work will make accessibility (according to section 5.4) a concern. If this is the case, recalling the pedestrian phase, closing the pedestrian crossing or use of non-invasive pedestrian detection (video, etc.) may be considered. Often temporary signal poles used for the span wire installation must be placed far away from the intersection in order to accommodate the construction work. In these cases, a separate temporary wood post that is used just for the pushbuttons and pedestrian indications would be required so that the pushbuttons can be placed close enough to the intended crossing to meet the requirements stated in section 5.4. The typical installation details for this separate, smaller post is shown in the standard drawings. See Figure 11-8 and Figure 11-9 for examples of pushbutton accessibility that require mitigation.
- Feasibility of recalling pedestrian phases – Detection is less beneficial if the green time of vehicle phase that is compatible with the pedestrian phase is typically always longer than the pedestrian crossing clearance time.
- Pedestrian volumes – Detection is less beneficial if there is a heavy pedestrian volume (e.g., pedestrian phase is serviced every cycle).

Figure 11-8 | Pedestrian Pushbutton Access – Example 1



Figure 11-9 | Pedestrian Pushbutton Access – Example 2

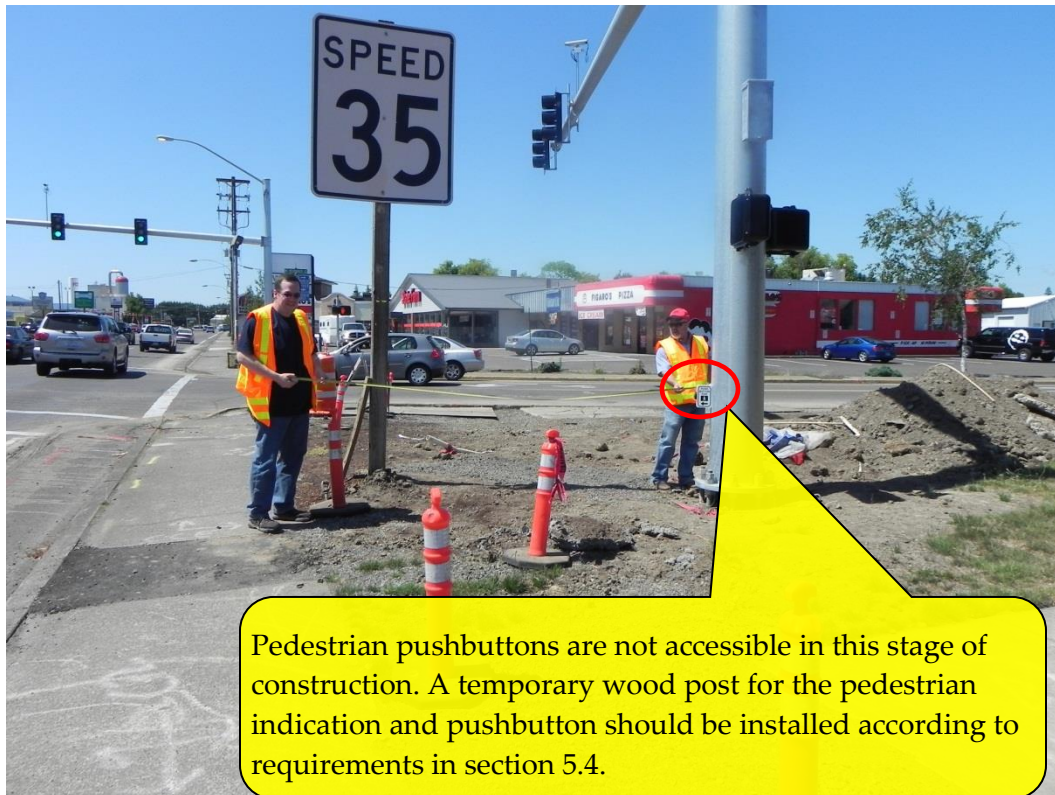

EMERGENCY PREEMPTION DETECTION

- Does the existing or permanent new signal have emergency preemption detection – If the existing signal has preemption detection, the temporary signal should also have preemption detection. If the existing signal does not have emergency preemption but the permanent signal will, the temporary signal should not have preemption detection.
- Needs of the emergency vehicle service providers – The need for temporary emergency vehicle preemption should be discussed with all interested parties. Understanding the main routes that emergency vehicles use can determine if preemption detection is needed primarily for only one or two approaches vs. each approach.
- Use of recalled pedestrian phases - The need for emergency vehicle preemption becomes less beneficial if pedestrian phases must be recalled. This is due to the requirements of the MUTCD which do not allow emergency preemption to shorten a conflicting flashing don't walk pedestrian phase.

11.6.6 Vehicle Detection

When used, the radar (or video) detection equipment should be mounted on a temporary signal pole or on a temporary illumination arm. Span wire mounting is not allowed. Note that the mounting locations are much more limited for a temporary signal and it may not be possible to provide detection for all movements depending on the intersection geometry. Extra detection devices may be considered if they can provide better coverage, but the added expense should be weighed against the expected benefits.

11.6.7 Wiring

Wiring for the temporary signal follows the same basic guidelines contained in chapter 5 for permanent signals. This section notes exceptions to chapter 5 and provides additional information specific to span wire installations. Note there are many ways to wire a traffic signal that work, but to achieve uniformity (which has many benefits for maintenance and construction), we strive to wire traffic signals in a consistent manner. Figure 11-10 illustrates the preferred method for wiring signal phases on a temporary span wire and is described in the following bullet points.

- All wiring for is routed overhead on the messenger cable for ease of installation and removal.
- The control cables for each the phase (drawn in red) goes to each pole terminal cabinet. One control cable is needed for each vehicle phase and each pedestrian phase. For example, the terminal cabinet on pole no. 1 will need 4 control cables from the controller cabinet because the pole no. 1 will provide power to equipment for 4 phases (phase 4 & phase 7 vehicle indications and ped phase 4 & ped phase 2 pedestrian indications and pushbuttons). Pole no. 2 also requires 4 control cables from the controller cabinet but note that those control cables bypass the terminal cabinet on pole no. 1.
- The control cables for the vehicle signal heads (drawn in light blue) come from the terminal cabinet on the pole to each signal head. Each signal head requires one control cable that comes directly from the terminal cabinet. For example, each large pole is powering 3 signal heads, requiring a total of 3 control cables coming from the terminal cabinet going to each piece of equipment. Daisy chaining signal heads is not allowed (e.g., powering one signal head from another signal head). Daisy chaining results in signal heads that have an indirect connection to the terminal cabinet and can make troubleshooting and maintenance more difficult.

The signal heads should be wired from the pole where a mast arm would be attached if a mast arm was used. However, there is an exception: if the construction staging requires the signal heads to shift location, the signal heads may be wired from the pole that they are shifting towards. This allows for an easier shift of the equipment as the wire from the terminal cabinet to the signal head is getting shorter, not longer. For example, if the signal heads located on the span between pole no. 4 and no. 7 will need

Traffic Signal Design Manual – Temporary Signal Plan

to shift towards pole no. 4 in a future stage, the control cables to each signal head (drawing in light blue coming from pole no. 7) may instead come from pole no. 4. In doing this, remember that control cables for these vehicle phases that were coming from pole no. 7 now need to go to pole no. 4 (pole no. 4 will now require a total of 6 control cables from the controller cabinet: phase 3, phase 8, phase 2, phase 5 FYA, ped phase 6 and ped phase 8).

- The control cables for the pedestrian indications and pushbuttons located on the large poles (poles no. 1 & 7) are installed in conduit attached to the large pole according to the standard drawings and therefore are not detailed on the plan sheets. Note that it is not recommended to place pedestrian indications and pushbuttons on the large pole, but instead on the small posts as described in the next bullet point to ensure that accessibility requirements for pushbuttons (see chapter 5) can be met for all stages of construction.
- The control cables for the pedestrian indications and pushbuttons located on the small posts (poles no. 3, 5, and 6) are from the terminal cabinet of the adjacent large pole. The conduit attached to the small post for wiring the pedestrian equipment is shown in the standard drawings.
- A bare spot will always occur on a portion of the span wire (no wiring attached to the messenger cable). In this example it is between pole no. 2 and pole no. 4
- The bubble notes show how the wiring would be detailed on the plan sheet. The number of control cables shown in each bubble note indicate how many control cables are attached to the messenger cable at that particular location. For example, the messenger cable between pole no. 7 and the first piece of signal equipment to the left (vehicle signal head for phase 7) has a total of 8 control cables attached (4 cables needed to power phases at pole no. 1 and 4 cables needed to power phases at pole no. 2). Moving to the left of the phase 7 signal head, the messenger cable now has 9 control cables attached (same 8 cables as previously described, plus one control cable from pole no. 1 to the phase 7 signal head). Every time the number of wires or cables attached the messenger cable changes a new bubble note is used.

Traffic Signal Design Manual – Temporary Signal Plan

Figure 11-10 | Preferred Method for Wiring Signal Phases on a Span Wire

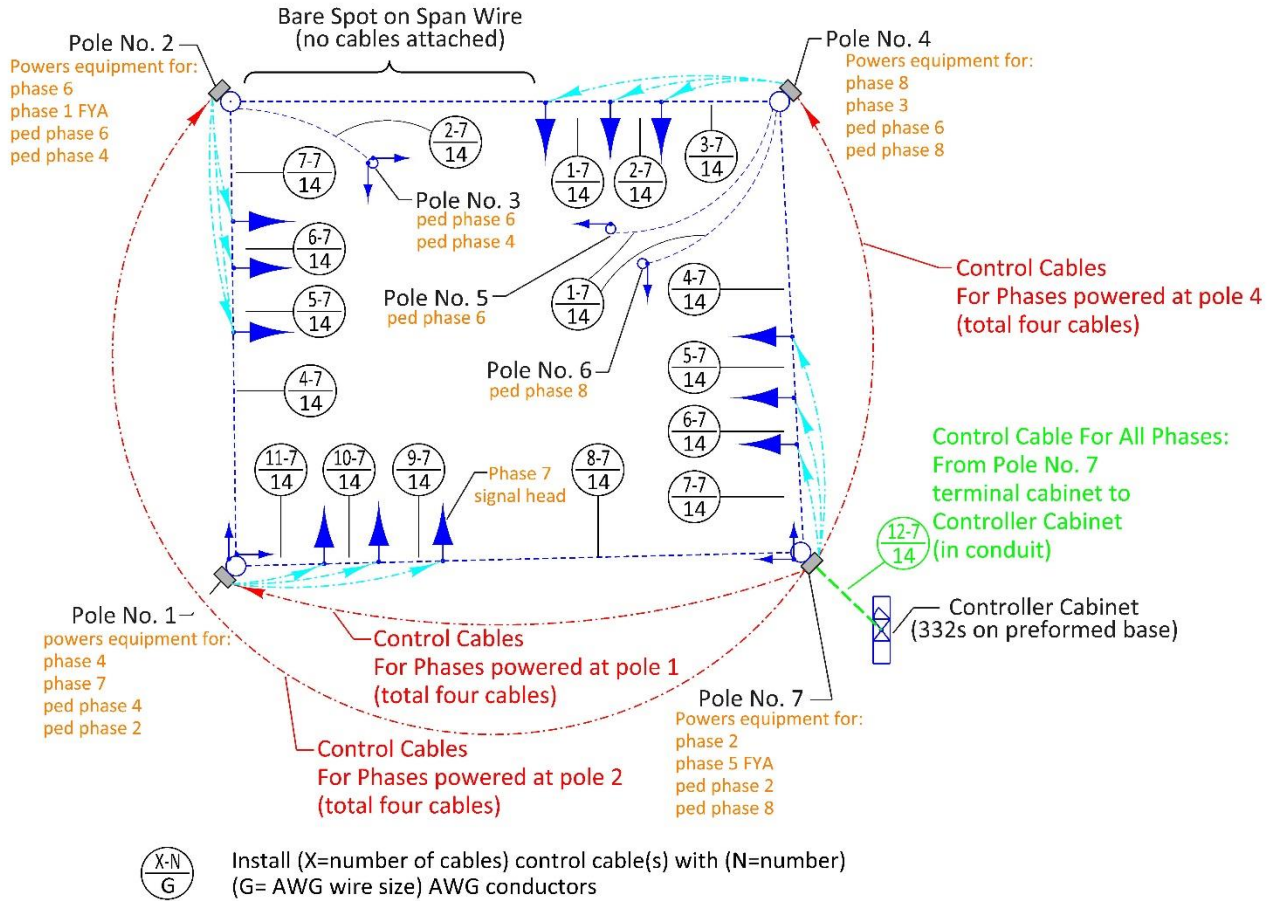

11.6.8 Staging

Signal designers should coordinate their work early in the process with the traffic control designer and the region signal operations engineer. This will assure the correct operation of the temporary signal and design of traffic control devices during all construction phases.

Depending on the complexity of the project, the temporary traffic control plans may detail specific stages and phases for construction (e.g., Stage I, phase 1; Stage I, phase 2; Stage II, phase 1, etc.). If specific stages/phases have been determined, the signal designer is required to produce a temporary signal plan sheet for each stage/phase that will result in a change to the temporary traffic signal. The following details should be shown for each stage:

- Lane use at the intersection
- Vehicle signal indications and pedestrian indications
- Lane use signing and other regulatory signing mounted on the signal structure
- Normal phase rotation diagram
- Detection, if used (pushbuttons, loops, etc.)
- Reference existing and/or proposed signal poles or curb lines (to help establish the location of the temporary features in relation to existing and/or proposed conditions)

Keep in mind that the construction staging that is produced for the contract plans is only showing one way to complete the required construction work. There is a strong possibility that the contractor will propose to modify some parts the staging/phasing shown in the plans. There is also the possibility that the contractor will propose an entirely different staging plan. If this occurs, the contractor will submit stamped working drawings for approval as per specification 00221.06.

Figure 11-11 through Figure 11-20 show each stage and phase of an example project with the traffic control plans (TCP) shown on the left side (produced by the traffic control plans designer) and the corresponding temporary traffic signal plans shown in the right side (produced by the signal designer). This example project was a modernization project to add capacity (lanes) at the intersection.

The temporary signal plans must correspond with and match the traffic control plans.

Traffic Signal Design Manual – Temporary Signal Plan

Figure 11-11 | Staged Construction Example – Stage I, Phase 1

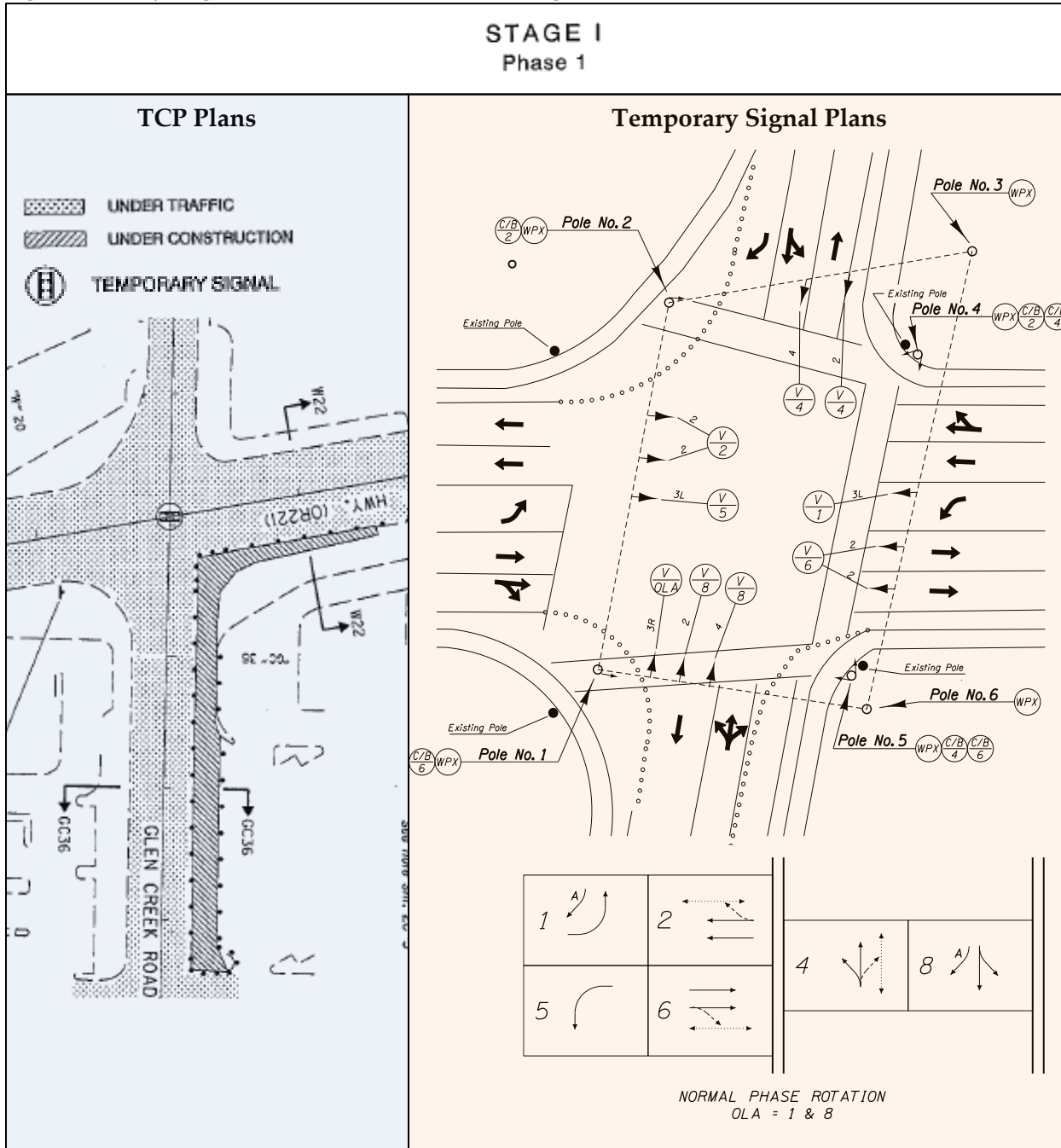

NOTE: Construction work taking place in the lower right quadrant will require a change from the existing lane use (left turn only lane & left-thru-right lane) to a left-thru-right lane on the bottom approach. This lane use change requires a change to the signal indications for phase 4.

Poles 1, 2, 3 & 6 (major poles) will stay in same location for entire temp staging.

Traffic Signal Design Manual – Temporary Signal Plan

Figure 11-12 | Staged Construction Example – Stage I, Phase 2

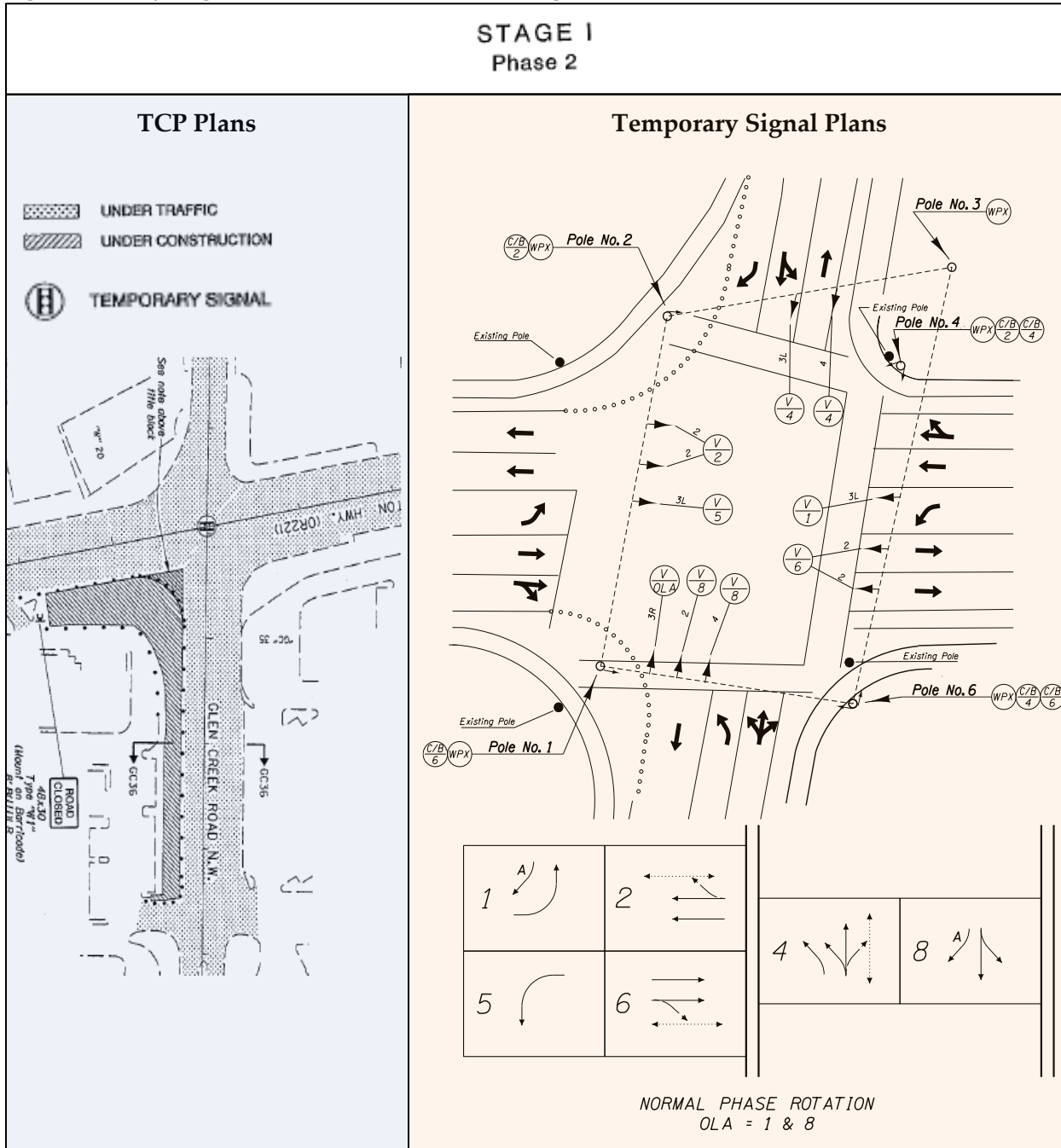

NOTE: Lane use on bottom approach changes from Stage 1, Phase 1 which requires a change to the signal indications for phase 4.

Pole no. 5 no longer needed.

Traffic Signal Design Manual – Temporary Signal Plan

Figure 11-13 | Staged Construction Example – Stage I, Phase 3

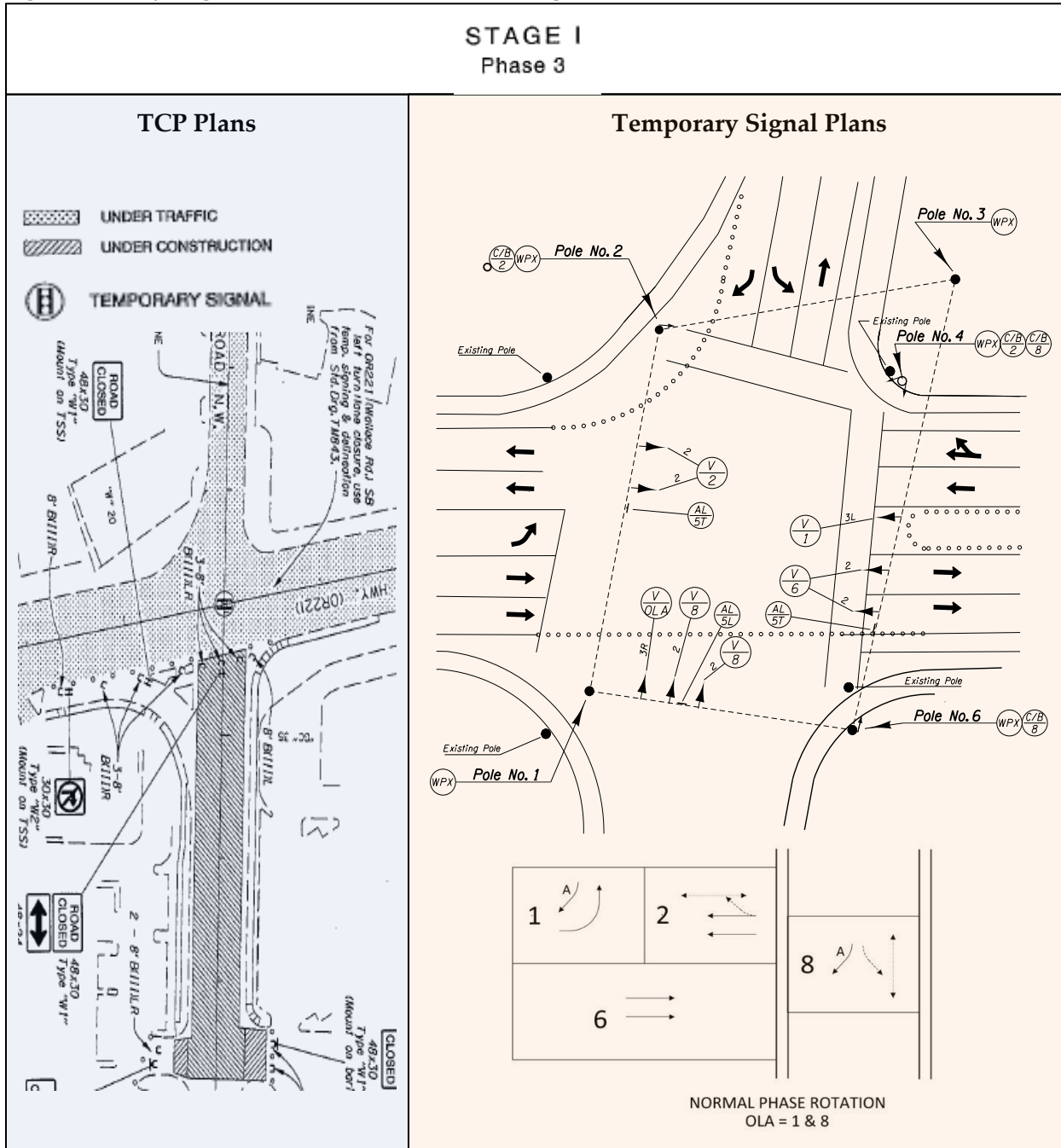

NOTE: The bottom approach is now closed, requiring lane use, regulatory signing, signal indication and signal phasing changes.

Traffic Signal Design Manual – Temporary Signal Plan

Figure 11-14 | Staged Construction Example – Stage I, Phase 4

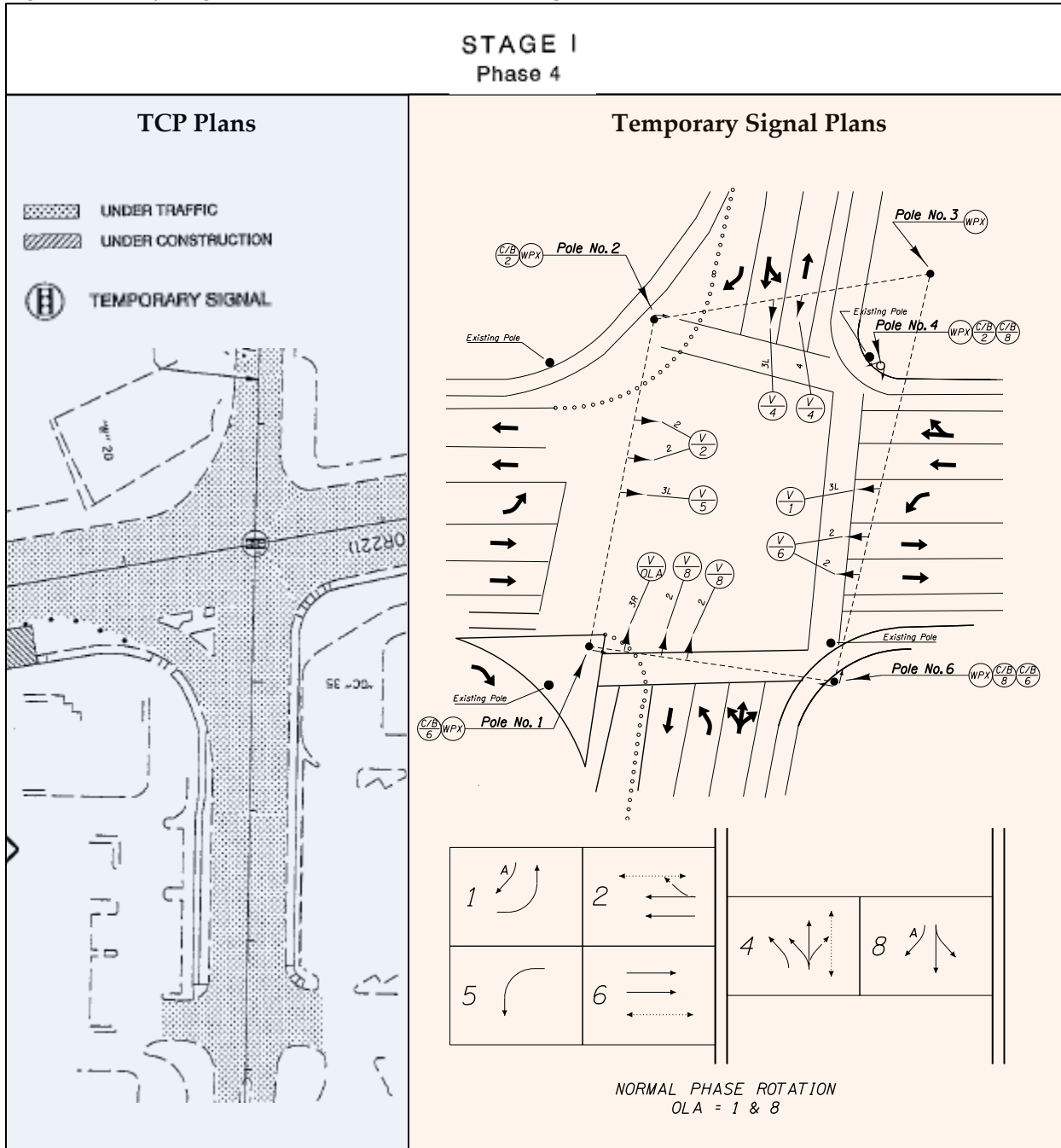

NOTE: The bottom approach final roadway cross-section is complete; however, the final lane configuration for the bottom approach cannot be used yet due to the severe lane off-set for the vehicle going straight thru the intersection from the top approach.

Traffic Signal Design Manual – Temporary Signal Plan

Figure 11-15 | Staged Construction Example – Stage II, Phase 1

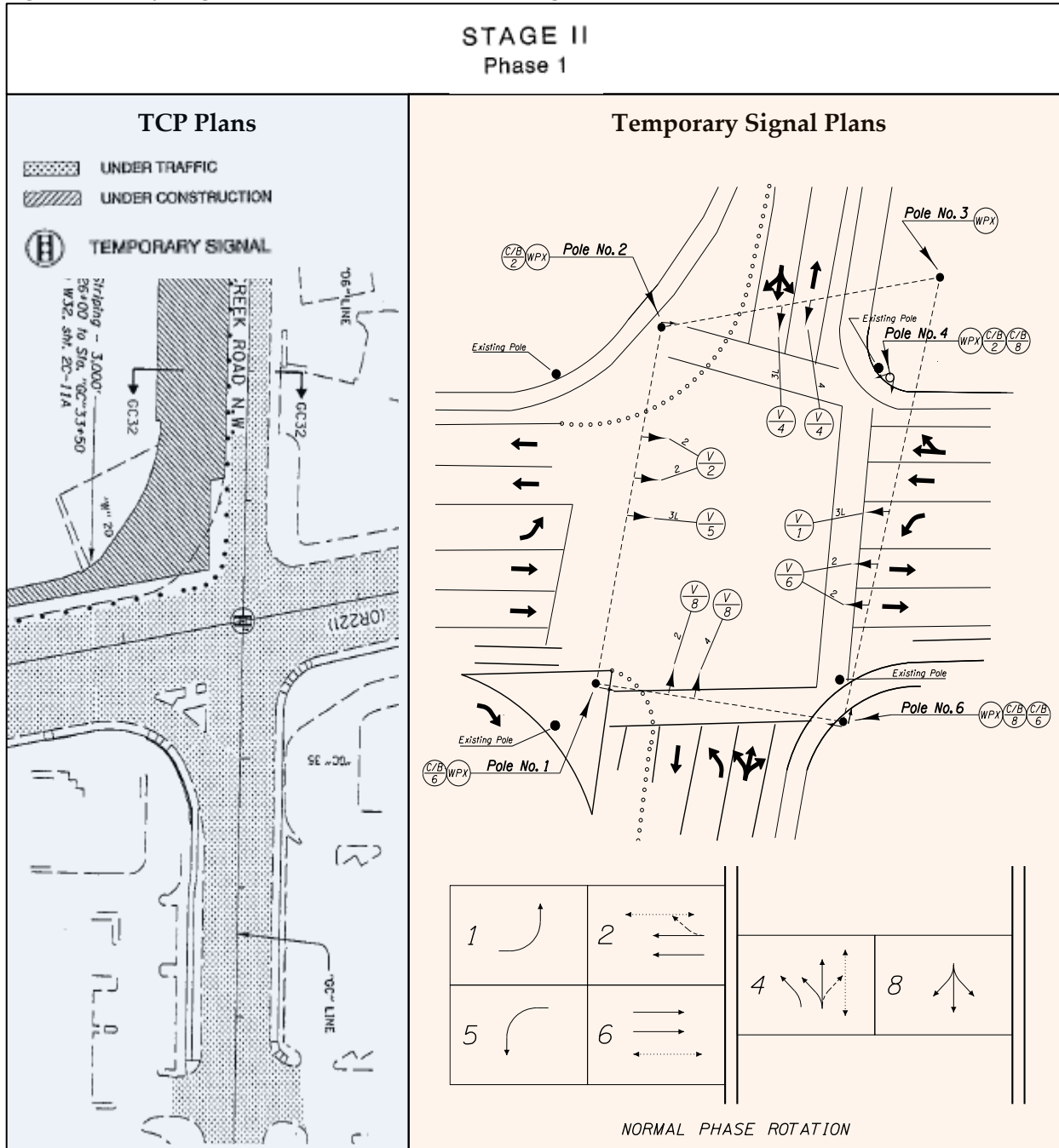

NOTE: The top approach lane use has changed to a single lane, requiring signal head and phasing changes (overlap A has been removed for this stage).

Traffic Signal Design Manual – Temporary Signal Plan

Figure 11-16 | Staged Construction Example – Stage II, Phase 2

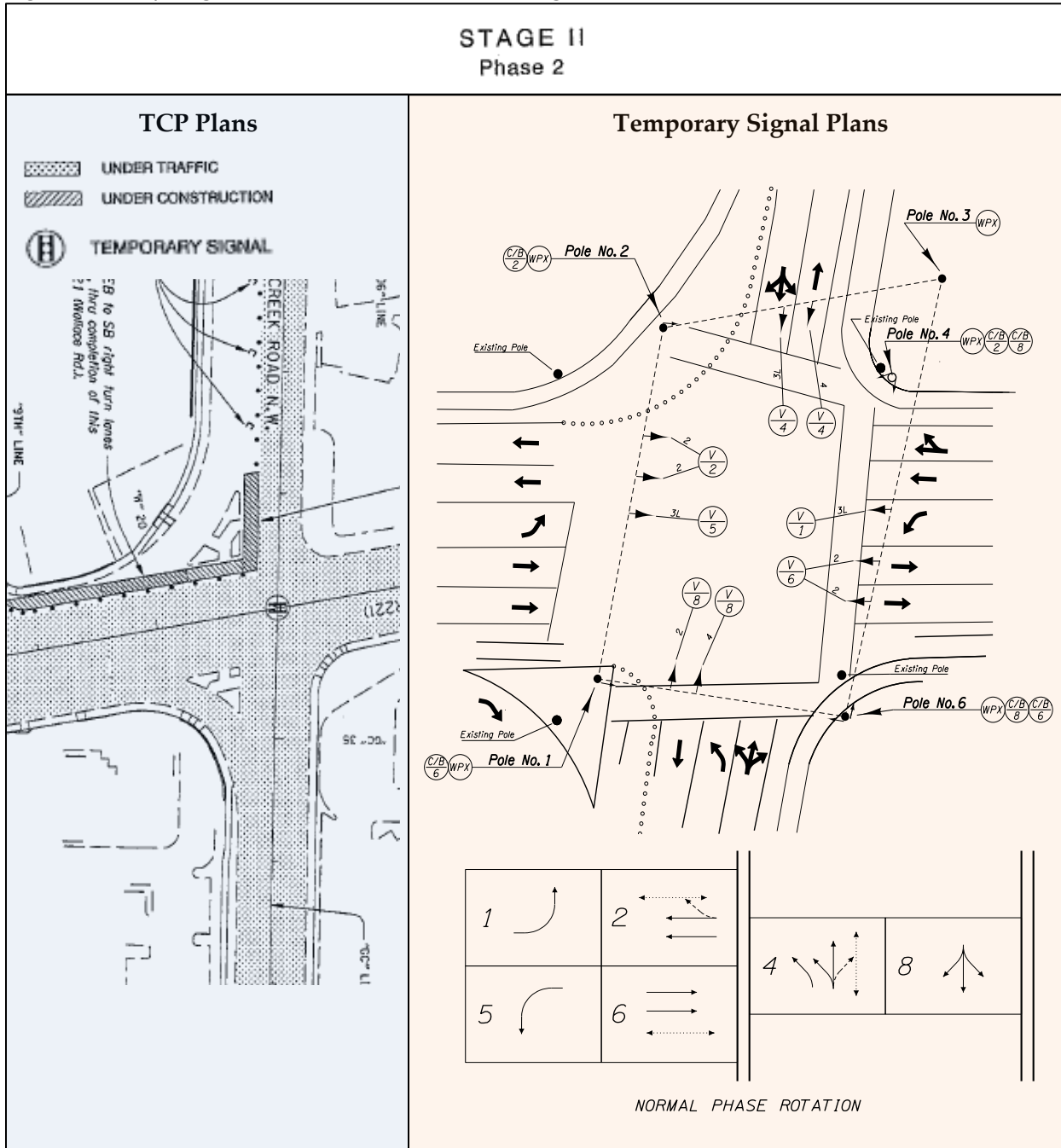

NOTE: No changes from Stage II, phase 1 (a separate temporary signal plan sheet for this stage is not needed. The temp signal plan should just indicate the plan sheet is valid for Stage II, phase 1 thru Stage II, phase).

Traffic Signal Design Manual – Temporary Signal Plan

Figure 11-17 | Staged Construction Example – Stage III, Phase 1

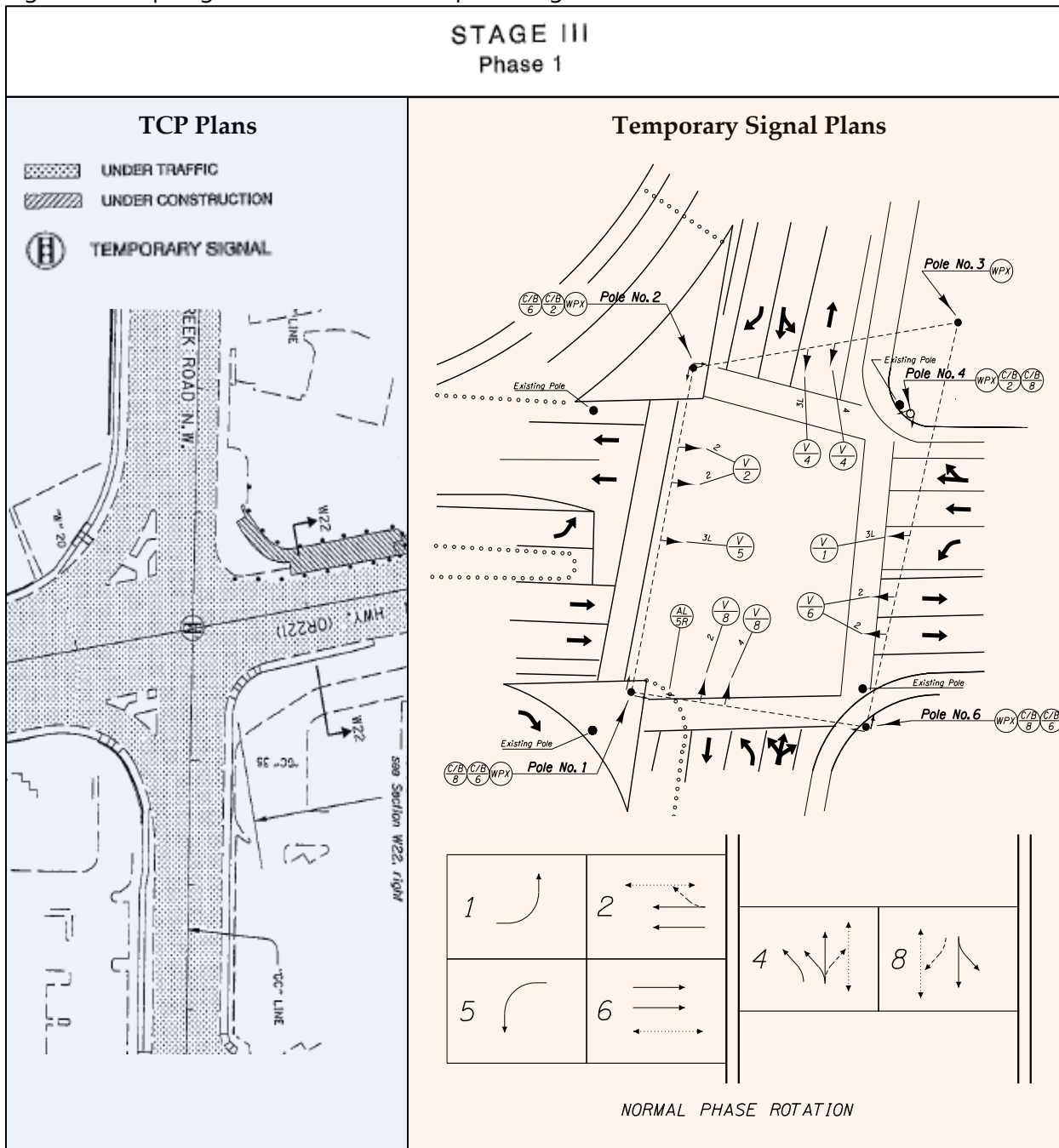

NOTE: The dual right turn lanes for the top approach are built but cannot be used until the permanent signal is turned on (cannot mix and match temporary and permanent signal installations).

All pedestrian crossings are now open.

Left approach dual left turn lane cannot be opened yet (receiving lanes not yet built).

Traffic Signal Design Manual – Temporary Signal Plan

Figure 11-18 | Staged Construction Example – Stage III, Phase 2

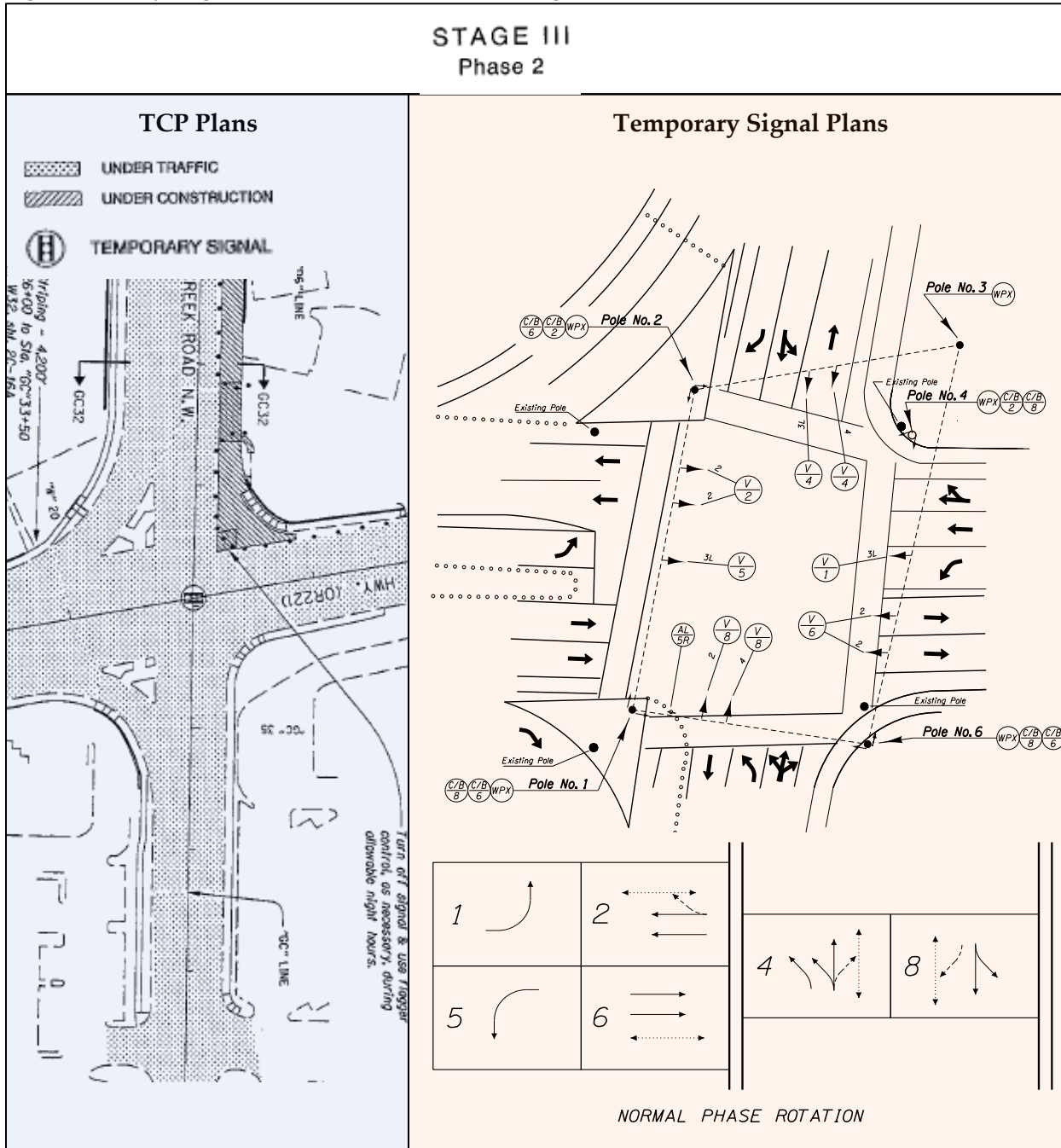

NOTE: No changes from Stage III, phase 1

Note that the TCP plans have a note for the contractor about turning off the signal and flagging for the small amount of work to be done in the upper right quadrant.

Traffic Signal Design Manual – Temporary Signal Plan

Figure 11-19 | Staged Construction Example – Stage IV

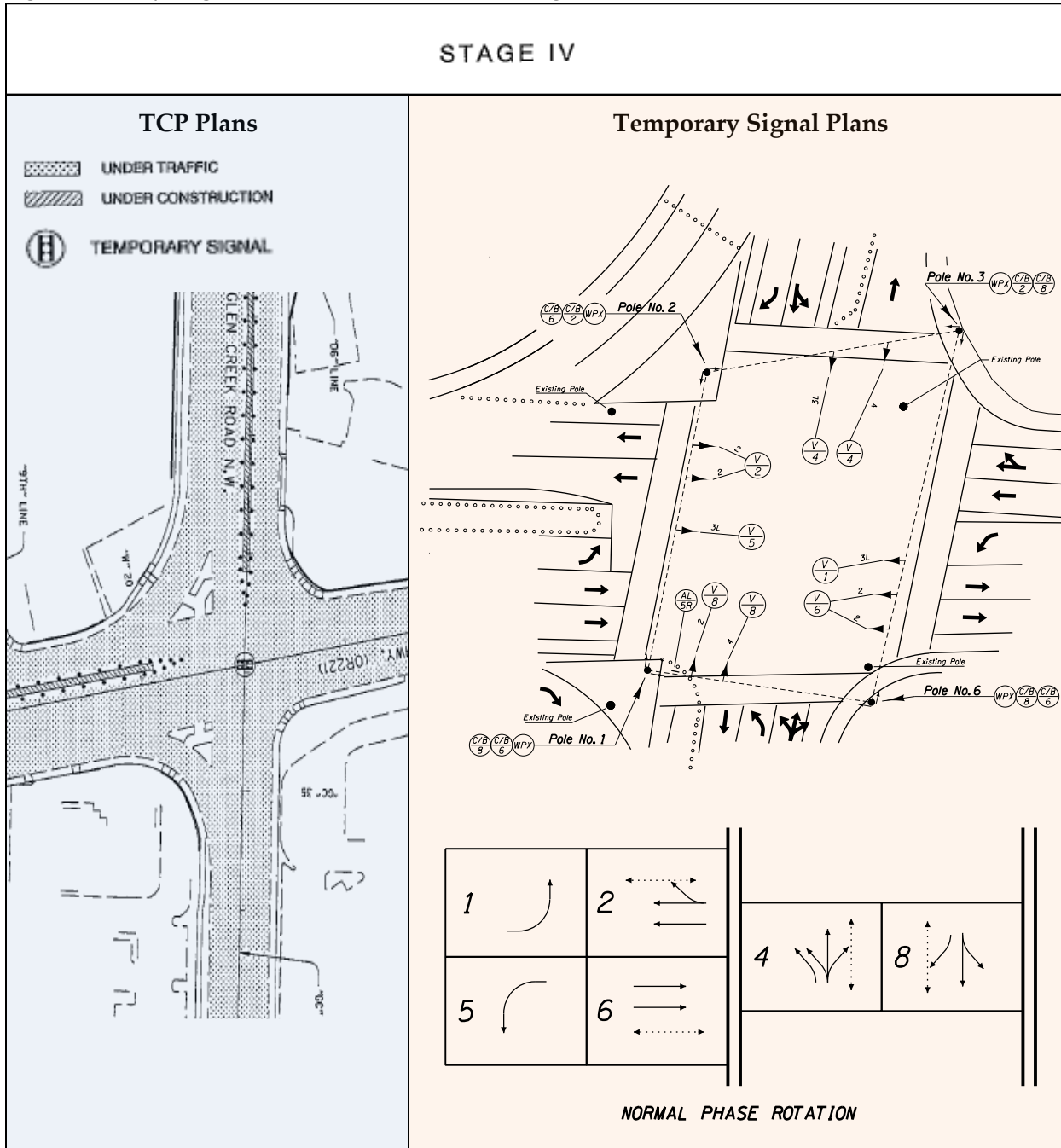

NOTE: The left approach left turn must be shifted to accommodate the median work.
 Pole no. 4 no longer needed.
 The next stage will be turning on the permanent signal installation.

Traffic Signal Design Manual – Temporary Signal Plan

Figure 11-20 | Staged Construction Example – Permanent Signal

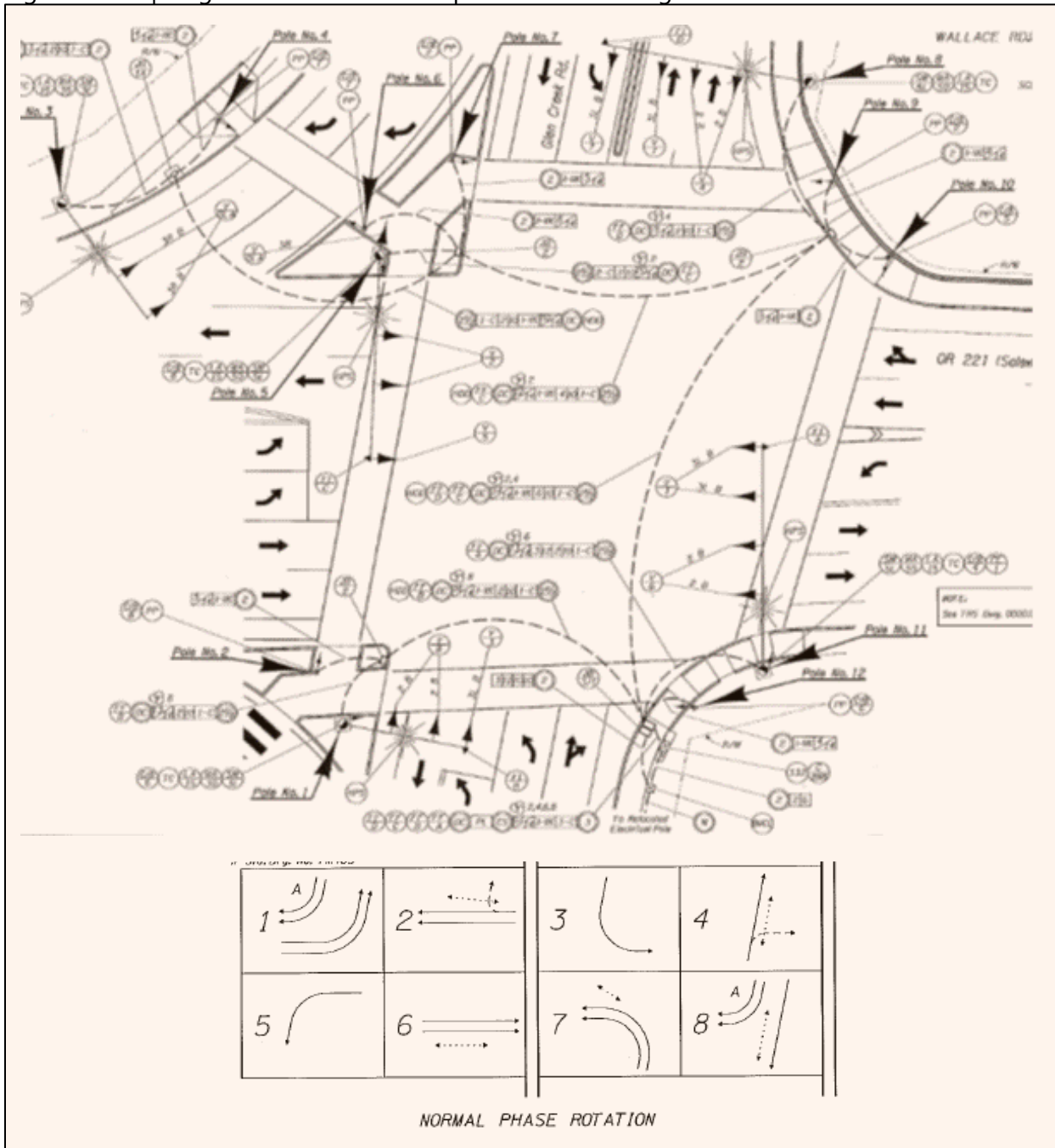

NOTE: Final configuration and phasing.

11.7 Temporary Bridge Signal Design

This type of temporary signal alternates traffic across the bridge one direction at a time in a single lane. Note that this type of operation may occur at other locations besides a bridge, but bridge work comprises the majority, hence the designation of “temporary bridge signal”. The location where vehicles will stop at each end of the bridge plus any accesses located between the two stop locations are important to consider early in the design process. All accesses shall be signalized.

11.7.1 Phasing

One lane, two-way signal operations require exclusive phasing with long all red clearance intervals to clear the “intersection”. This is usually accomplished by the use of dummy phases. However, modern signal software may be able to accommodate the long red clearance intervals without dummy phases. Verify with the region signal timer.

The standard phasing for this type of operation is shown in Figure 11-21, which allows for up to 4 separate accesses on each end of the single lane to be signalized. Accesses located in the middle of the single lane are not allowed and should be closed.

Pedestrian phases are typically not used given the typical location where this type of signal operation is used (e.g., rural bridge location), but verify the TPAR needs and requirements with the traffic control designer.

Figure 11-21 | Standard Temporary Bridge Signal Phasing

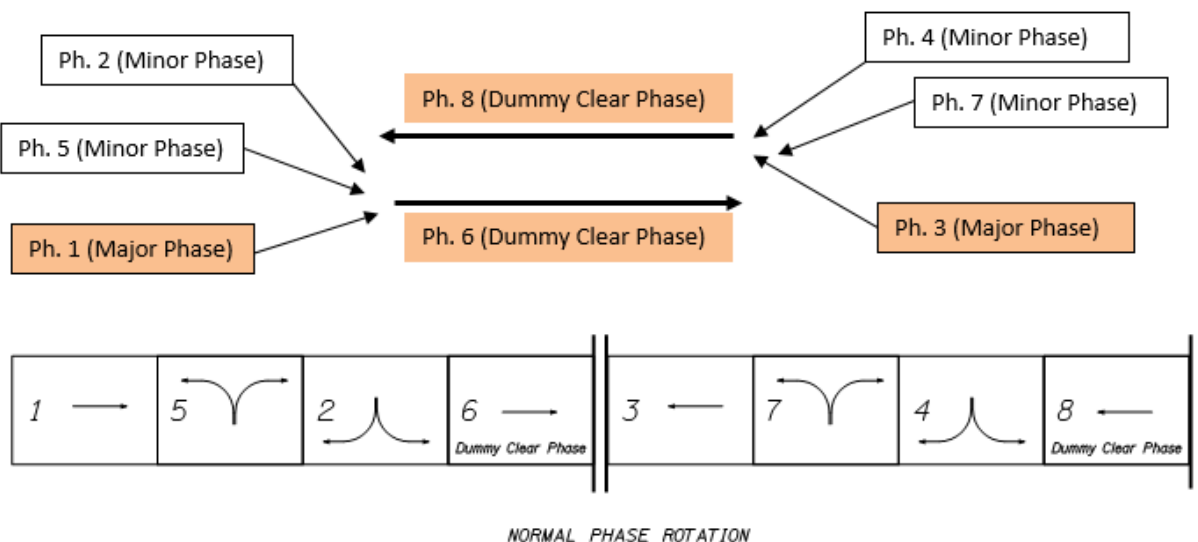

11.7.2 Sight Distance

It is important to maintain a good line of sight from stop line to stop line at each end of the single lane in the event that the signal goes into flashing operation. A vehicle stopped at one stop line should be able to see a vehicle stopped at the opposing stop line. See Figure 11-22. A vehicle stopped at the stop line should also be able to see an opposing vehicle as it approaches at all points on the one lane alignment. See Figure 11-23. If the line of sight is not good and the signal goes into flash, a driver who cannot see opposing traffic will proceed ahead (after stopping) and may encounter an opposing vehicle in the single lane section, resulting in a crash or the need for one vehicle to reverse.

Figure 11-22 | Sight Distance from Stop Line to Stop Line

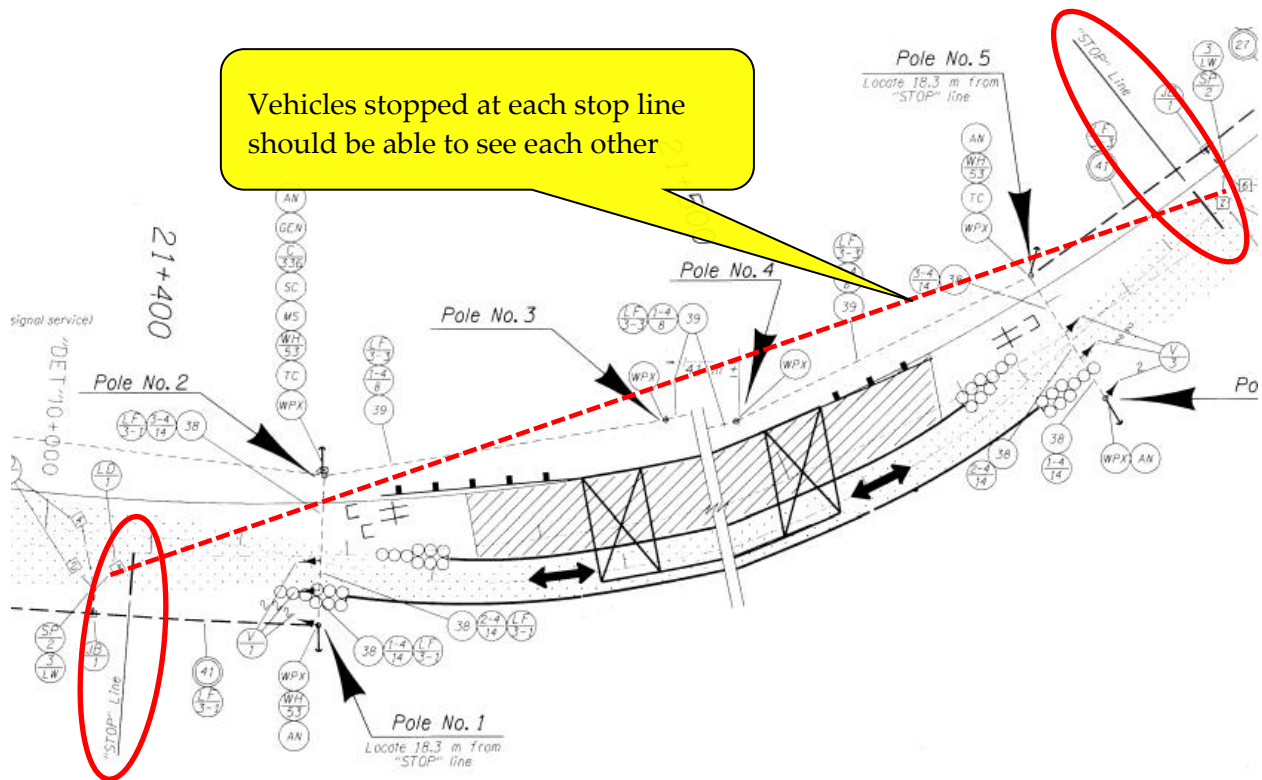

The signal designer must understand the traffic control plan layout and coordinate with the traffic control plans designer, the roadway designer, and the region traffic engineer to identify and address/mitigate any sight distance concerns.

Traffic Signal Design Manual – Temporary Signal Plan

Figure 11-23 | Sight Distance from Stop Line to All Points on the Alignment

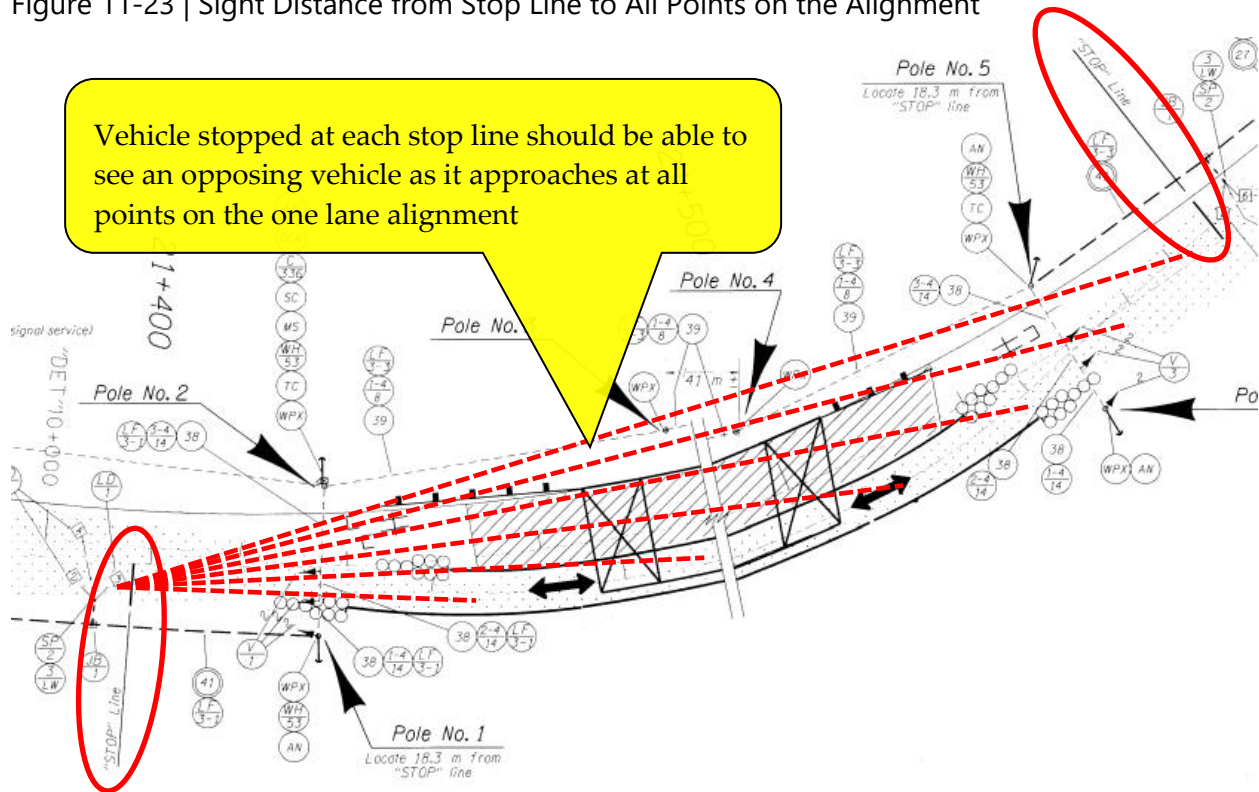

Things that may negatively affect the line of sight include a single lane section that is long, the roadway horizontal/vertical curvature, vegetation, and/or cut slopes. Some of these things might be addressed relatively easily, such as removal of vegetation. See Figure 11-24.

If a good line of sight between the two stop lines cannot be achieved, other means of traffic control are recommended (e.g., 24/7 flagging or pilot cars). However, a robust back-up plan for the signal going into flash may also be an acceptable alternative if supported by the region traffic engineer and it is detailed in the contract documents (e.g., real-time signal monitoring and alerts with flaggers on stand-by that can respond rapidly).

Figure 11-24 | Sight Distance Condition of Signal Turn-on Example

Note:
 Prior to signal operation, remove trees and vegetation south of the straight line identified in the roadway plans, to establish a clear line-of-sight between temporary signal STOP lines.

The sight distance to the signal indications (MUTCD requirement) as well as the sight distance to the end of the expected queue (stopping sight distance) should also be verified. Supplemental vehicle signal heads, alternative detection zones and signal timing strategies, and/or additional temporary traffic control devices (e.g., PCMS) may be appropriate mitigation measures.

11.7.3 Stop Line Location

Standard drawing TM870 shows the typical layout for signing and pavement markings that are used for a temporary bridge signal. The stop line is shown as 60 feet (typical) from the signal heads, which is slightly more than the minimum 45-foot value to provide a more comfortable viewing angle for the driver. The 60-foot value should work well for the majority of applications. However, if it is determined the stop line needs to be placed closer or farther than 60 feet based on site-specific constraints, dimension the distance on the temporary signal plan sheet to properly override the standard drawing.

11.7.4 Signal Head Alignment

The signal heads should be aligned over the receiving lane of the single lane, which depending on the placement of the signal poles and roadway geometry may require a slight shift when the one-lane alignment moves to the other side. Note how the signal head alignment changes between Stage 1 and Stage II in Figure 11-25 and Figure 11-26.

Figure 11-25 | Stage I Signal Head Location

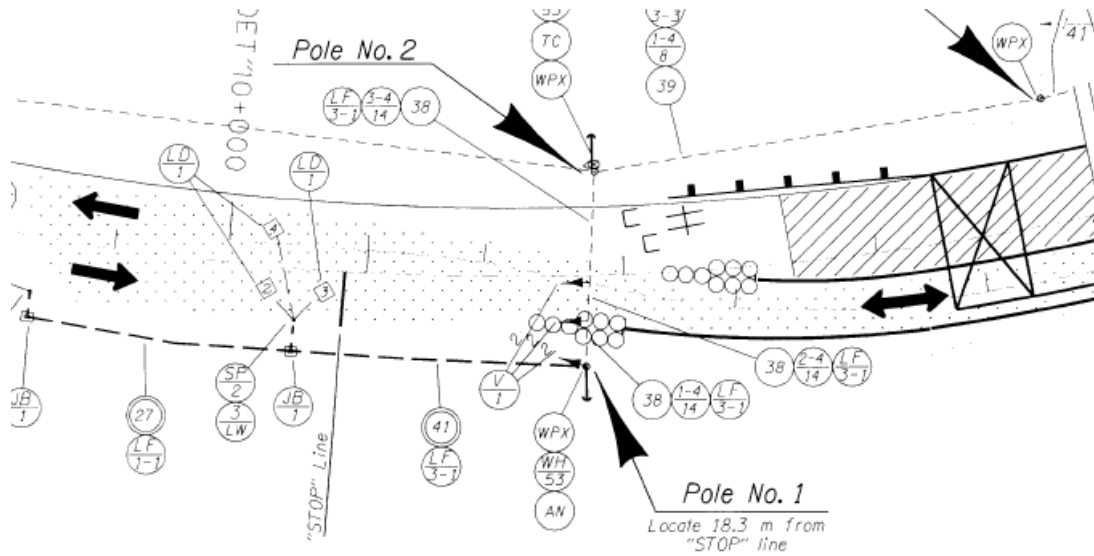
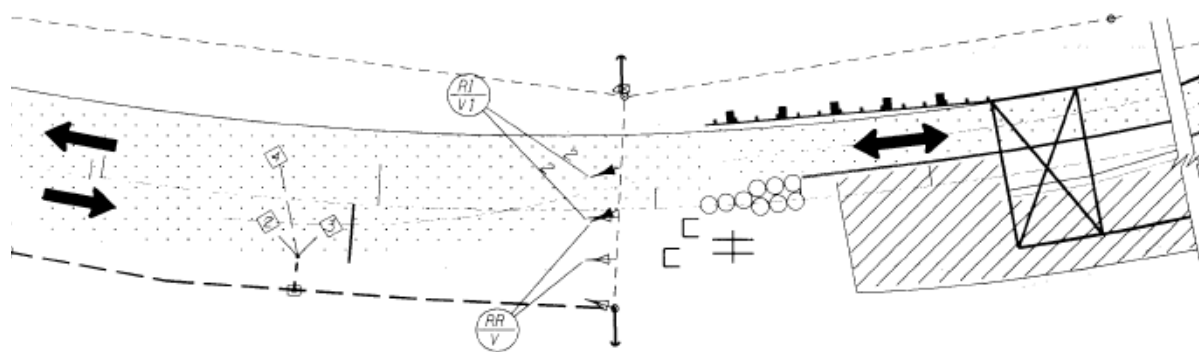

Figure 11-26 | Stage II Signal Head Location



11.7.5 Vehicle Detection

Temporary bridge signals shall have vehicle detection. Detection promotes slower traffic speeds in the workzone and efficient operation:

- It allows the signal to “rest in red” when there is no demand. When a vehicle approaches during the “rest in red” condition, it must slow down prior to getting a green indication.
- It improves the efficiency of an inherently inefficient signal operation (exclusive phasing with long clearance intervals) and manages queues better.

The standard placement for detection zones of the major phases is 110 feet from the stop line with an additional 5 feet beyond the stop line. A detection zone 60 feet from the stop line in the OPPOSING lane should also be included to detect vehicles that are likely to shift out of the approach lane when entering the single lane. This detection is accomplished by a near-range unit. The stop bar is typically located 60 feet from the signal heads, which makes the pole supporting the signal indications too far away to mount the detection unit (the near side device is only capable of 140 feet of detection). Install a separate wood pole to mount the detection unit near the stop line to get the necessary detection zone coverage. Figure 11-27. See chapter 6 for more details on the detection units.

The standard placement for detection of the minor phases follows the standard used for presence detection of permanent signals (total area of detection zone extends approximately 75 feet from the stop line with 2 small zones in front of the stop line). If the minor phase approach is short in distance (e.g., to a driveway), the detection zone distance should be shorted accordingly. See chapter 6 for more details.

Figure 11-27 | Temporary Bridge Signal Standard Detection - Mainline

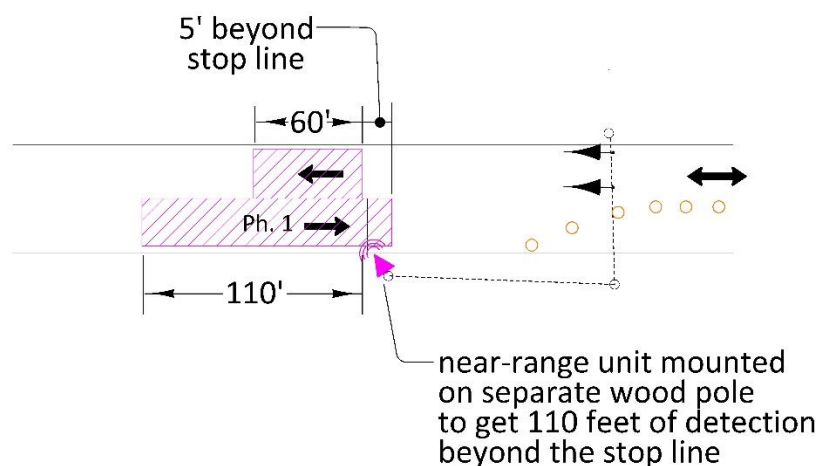

11.7.6 Bicycle Detection

Temporary bridge signals may use detection specifically for bicycles to allow an extension of the green time and clearance phase. The need for bicycle detection should be documented in the operational approval, based on factors such as the temporary bridge signal geometry (length, width, vertical grade, and presence of bicycle lanes), frequency of bicycles, speed differential between bicycles and vehicles, etc.

Pushbuttons have been used in the past and provide the most reliable form of bicycle detection for this type of installation; there is no chance of false call from vehicular traffic and it works for all types of bikes. See Figure 11-28 for an example of pushbutton detection. Radar detection may be used if the detection zones can be placed such that false calls from vehicles will not occur and the region signal timer is confident that the detection zone can adequately accommodate bike traffic. It is important to have proper signing and/or striping in place to let bicycles know how to properly navigate through the signal if detection has been provided.

Portable temporary traffic signals (see section 11.8) cannot accommodate bicycle detection.

Figure 11-28 | Temporary Bridge Signal Bicycle Detection

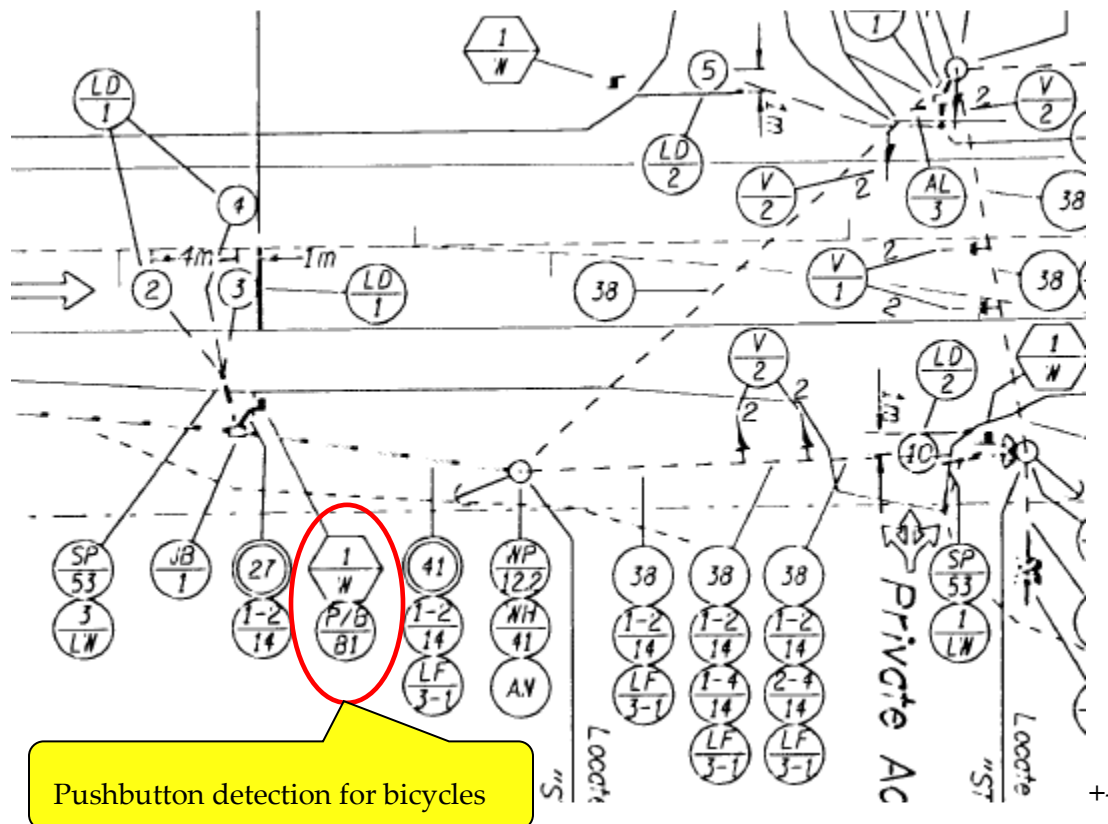

11.8 Portable Temporary Traffic Signal

This is a very specific type of temporary traffic control, typically used in lieu of a temporary bridge signal (one lane, two-way signal operation). This device requires operational approval but does not require design approval. Because this product is an off-the-shelf system that the contractor is responsible for timing, there is no need for a temporary signal plan sheet. All of the details for installation and operation of this device are contained entirely within the operational approval letter, the temporary traffic control plan sheets, and specification 00227 (in multiple subsections). The EOR for the temporary traffic control plans (not the signal designer) is responsible for detailing the use of this device on the project.

Portable temporary traffic signals are being used more often and their features have improved considerably since their introduction (and continue to rapidly improve). Coordinate with the state traffic operations engineer, the state traffic signal engineer, region traffic, and the traffic control plans designer to determine if a portable temporary traffic signal (which is less costly and more flexible for staging needs) is an acceptable alternative to a standard temporary signal.

STE operational approval is REQUIRED for use of a portable temporary traffic signal.

Temporary signal plan sheets are NOT needed. Design approval is NOT required.

11.9 Standard Drawings and Specifications Applicable to Temporary Signals

The following is a list of standard drawings and specifications that relate only to temporary signals and should be well understood by the signal designer when designing a temporary signal:

- Standard drawings
 - TM870 (bridge construction)
 - TM452 (temporary wood strain pole details)
 - TM453 (temporary pedestrian wood post, guy wire/anchor and luminaire arm details)
 - TM454 (temporary controller cabinet, service cabinet, meter base & terminal cabinet)
 - TM456 (temporary spanwire mounting details for vehicle signals, signs, and fire preemption)
- Specifications
 - Entire 00227 section (temporary traffic signals and illumination)

Other standard drawings/details and specifications (that also apply to permanent signals) will be needed, as applicable, for the installation of a temporary signal. See chapter 17 and chapter 18 for more information on standard drawings and specifications.