

OPERATION & MAINTENANCE MANUAL

Water Quality Biofiltration Swale

Manual prepared: April, 2019

DFI No. D001200

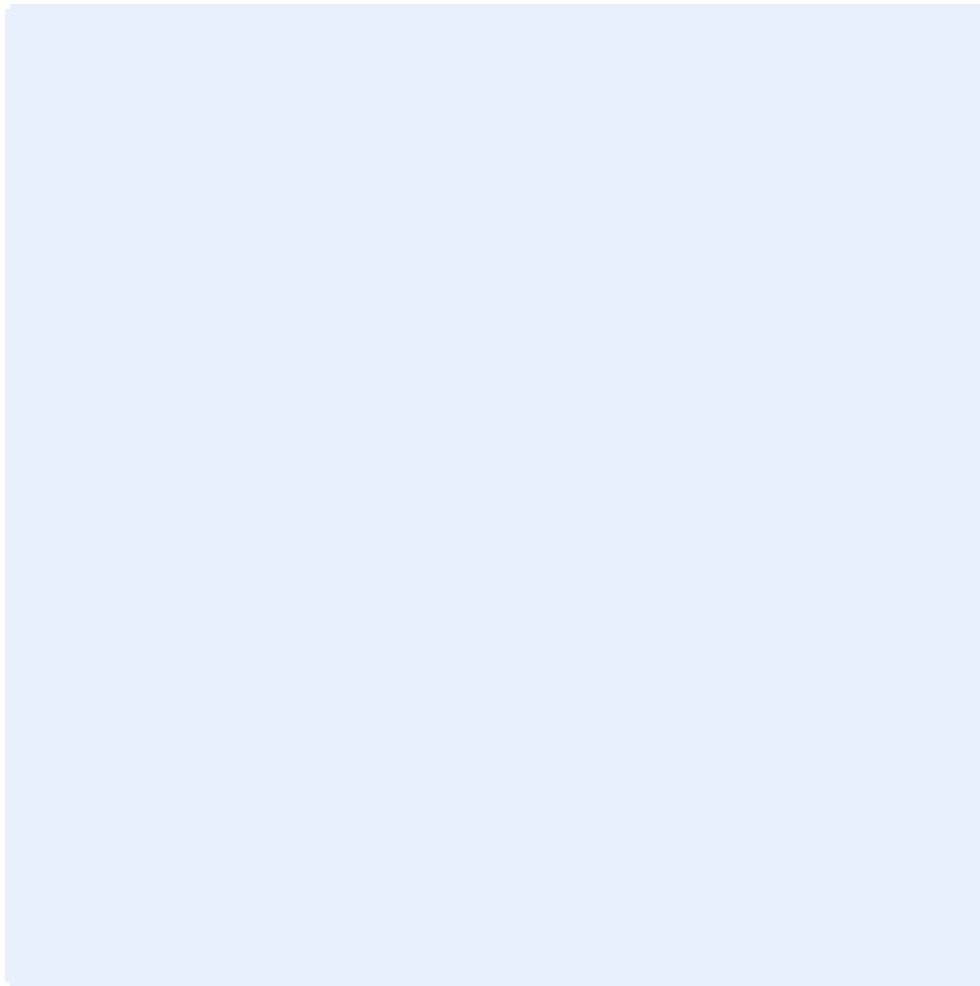

Figure 1: DFI No. D001200, looking [note cardinal direction]

Identification

Drainage Facility ID (DFI): D001200
Facility Type: Water Quality Biofiltration Swale
Construction Drawings: (V-File Numbers) 52v-044
Location: District: 01
Highway No.: 09
Mile Post: 82.97 to 82.97, [left]

1. Manual Purpose

The purpose of this manual is to outline inspection needs and summarize maintenance actions.

2. Facility Location

The location map below details the facility location. The highway, mile posts, side streets, access location, and stormwater flow directions are noted on the map.

Facility location type: Roadway shoulder

Flow direction: [west to east]

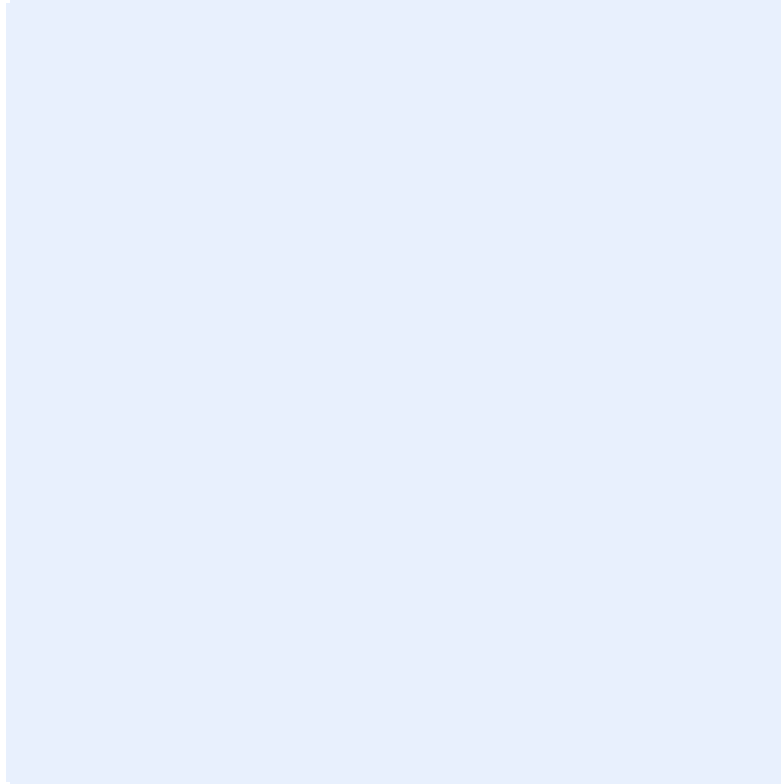

Figure 2: Facility location map

3. Facility Summary

The length and width of a swale is based on the bottom dimensions.

The bottom length and bottom width of the swale is:

Bottom Length (feet)	Bottom Width (feet)
110	0

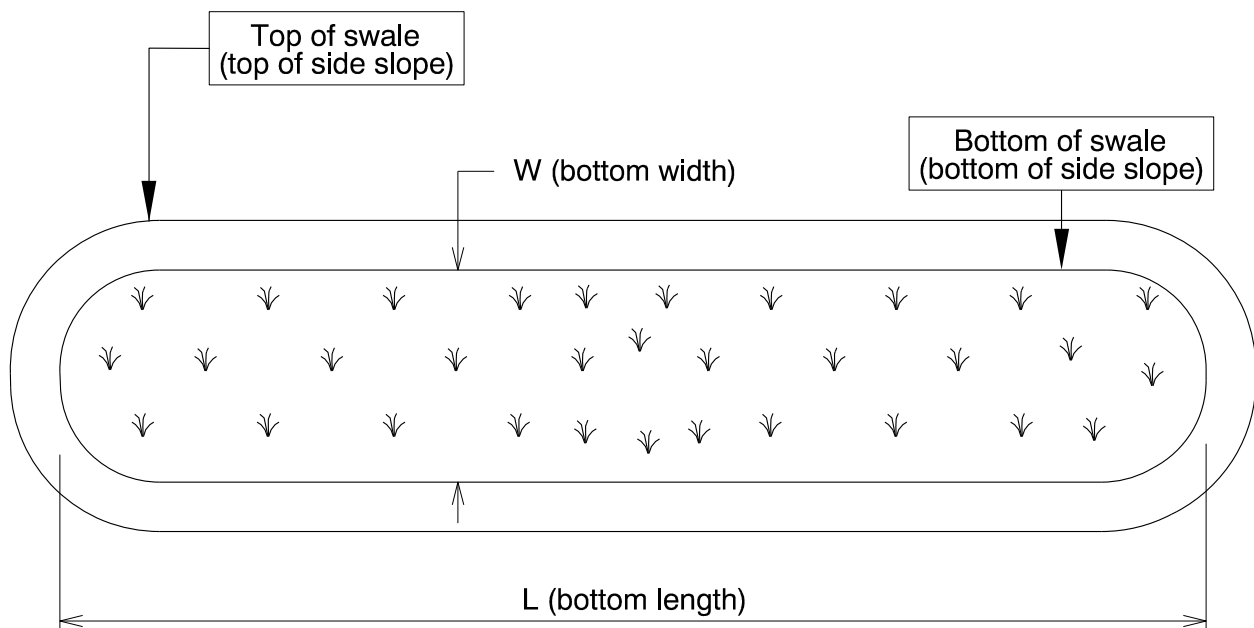

The depth of the swale is the vertical distance measured from the bottom of the swale to the top. The slope of the swale sides is presented by a vertical distance (rise) followed by the horizontal distance (run).

Depth and side slopes:

Depth (feet)	Rise (feet)	Run (feet)
varies	varies	varies

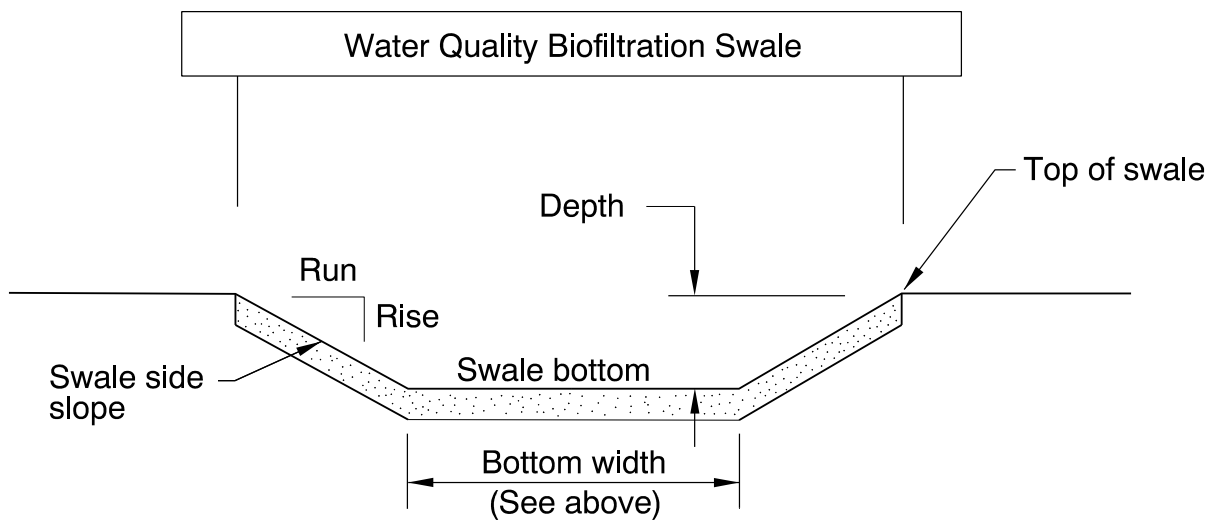

Site Specific Information:

4. Facility Access

Maintenance access to the facility:

<input type="checkbox"/> Roadside pad	<input checked="" type="checkbox"/> Roadside shoulder
<input type="checkbox"/> Access road with Gate	<input type="checkbox"/> Access road without Gate

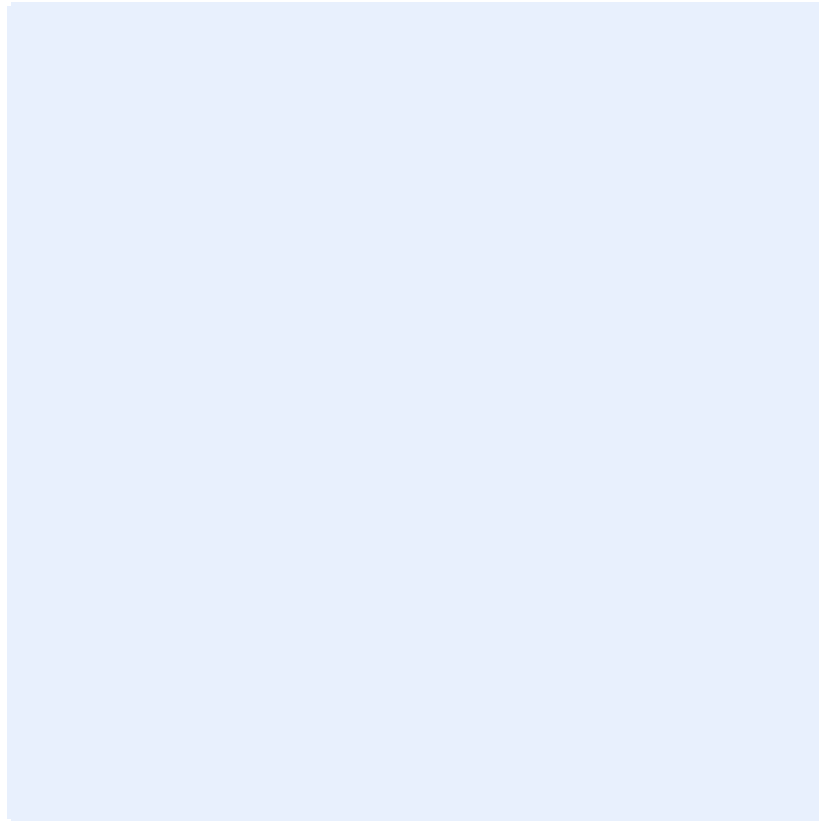

Figure 3: [insert post construction facility access photo and caption text]

5. Operational Components / Maintenance Items

Classification

This facility is classified as an:

<input checked="" type="checkbox"/> On-line Swale	<input type="checkbox"/> Off-line Swale
A swale that does not include a high flow bypass component; flow drains into and through the facility	A swale that treats low/small flows and diverts high flows using a bypass component

Bypass Component

This facility includes a high flow bypass component:

<input checked="" type="checkbox"/> No	<input type="checkbox"/> Yes
There is no bypass component. High flows drain into and through the facility	There is a bypass component. Only low/small flows drain into the swale. High flows are diverted around the swale using a bypass component

Operational Components

A swale has many components that assist with treatment, conveyance, and reducing flow velocity to minimize erosion. The components in use can vary depending if the facility was designed to operate on-line or off-line. The facility components table (**Table 1**) has been provided to highlight the applicable components for this facility. The component is in use when the box contains an “x” (e.g.).

The Standard Operation Manual for Water Quality Biofiltration Swales (implemented March 2017) outlines facility operation, typical footprint configuration, and component definitions and details. A link to the manual is attached to the feature marker in TransGIS.

<https://gis.odot.state.or.us/TransGIS/>

Operational Plan

The applicable standard operational plan for this facility is:

<input checked="" type="checkbox"/> Operational Plan A	<input type="checkbox"/> Operational Plan B	<input type="checkbox"/> Operational Plan C
An on-line swale with roadside ditches	An on-line swale with piped inlets and outlets	An off-line swale with a piped high flow bypass
A standard operational plan illustrates the general facility footprint configuration and explains the purpose of each facility component. Operational plans (A, B, C) are provided in the Standard Operation Manual.		

See Appendix A for the site specific operational plan.

Maintenance Items

Operational components marked in **Table 1** should be inspected and maintained according to Section 7. Each facility component is defined and detailed in the Standard Operation Manual using the associated ID number indicated below.

Table 1: Swale Components		ID #
Manholes/Structures		
Pre-treatment manhole	<input type="checkbox"/>	S1
Weir type flow splitter/flow splitter manhole	<input type="checkbox"/>	S2
Orifice type flow splitter/flow splitter manhole	<input type="checkbox"/>	S3
Standard manhole	<input type="checkbox"/>	S4
Swale Inlet		
Pavement sheet flow	<input checked="" type="checkbox"/>	S5
Inlet Pipe (s)	<input type="checkbox"/>	S6
Open channel inlet	<input checked="" type="checkbox"/>	S7
Riprap pad	<input type="checkbox"/>	S8
Ground Cover		
Grass bottom	<input checked="" type="checkbox"/>	S9
Grass side slopes	<input checked="" type="checkbox"/>	S10
Granular drain rock	<input type="checkbox"/>	S11
Plantings	<input type="checkbox"/>	S12
Underground Components		
Geotextile fabric	<input type="checkbox"/>	S13
Water quality mix	<input checked="" type="checkbox"/>	S14
Perforated pipe	<input type="checkbox"/>	S15
Porous pavers (access grid)	<input type="checkbox"/>	S16
Flow Spreader		
Rock basin (used at inlet)	<input type="checkbox"/>	S17
Anchored board (midpoint of swale or every 50 feet along swale bottom)	<input type="checkbox"/>	S18
Other: class 50 riprap	<input checked="" type="checkbox"/>	S19
Swale Outlet		
Catch basin with grate	<input type="checkbox"/>	S20
Outlet Pipe (s)	<input type="checkbox"/>	S21
Open channel outlet	<input checked="" type="checkbox"/>	S22
Auxiliary Outlet:	<input type="checkbox"/>	S23
Outfall Type		
Waterbody (Creek/Lake/Ocean)	<input checked="" type="checkbox"/> C	S24
	<input type="checkbox"/> L	
	<input type="checkbox"/> O	
Ditch	<input type="checkbox"/>	S25
Storm drain system	<input type="checkbox"/>	S26
Outfall Components		
Riprap pad	<input type="checkbox"/>	S27
Riprap bank protection	<input type="checkbox"/>	S28

6. Maintenance

Maintenance Frequency/Maintain Records

- a. Inspect annually. Preferably prior to the rainy season.
- b. Clean and maintain as necessary. Refer to Activity 125 for conditions when maintenance is needed.
- c. Keep a record of inspections, maintenance, and repairs.

Maintenance Guide/Maintenance Actions

The ODOT Routine Road Maintenance Water Quality and Habitat Guide (the *Blue Book*) outlines the standard maintenance actions for water quality facilities under Activity 125.

There are standard maintenance tables for standard ODOT designs. The maintenance tables describe the maintenance component, the defect or problem, the condition when maintenance is needed, and the recommended maintenance to correct the problem. Use the following tables to maintain ODOT swales:

- Table 1 (General Maintenance): Contains general maintenance and inspection guidelines that are applicable to all ODOT water quality facilities
- Table 3 (Maintenance of Water Quality or Biofiltration Swales): Contains maintenance information for swales

The *Blue Book* can be viewed at the following website:

http://www.oregon.gov/ODOT/Maintenance/Documents/blue_book.pdf

7. Limitations

Access grid installed:

<input checked="" type="checkbox"/> No	<input type="checkbox"/> Yes
There are (Choose applicable weight: no, light, med., heavy) duty porous pavers installed in this swale	

Swales are designed to allow equipment access along the bottom. If an access grid is **NOT** installed, vehicles entering the swale can create depressions (tire ruts), damage vegetation, and damage structural components (e.g. flow spreaders). These conditions may result in poor treatment and drainage performance.

Equipment wheels should be kept on the tops and side slopes. Mower arms may be run along the swale bottom.

8. Waste Material Handling

Material removed from the facility is defined as waste by the Department of Environmental Quality (DEQ). Refer to the roadwaste section of the ODOT Maintenance Yard Environmental Management System (EMS) Policy and Procedures Manual for disposal options:

http://www.oregon.gov/ODOT/Maintenance/Documents/ems_manual.pdf

Contact any of the following for more detailed information about management of waste materials found on site:

ODOT Clean Water Unit	(503) 986-3008
ODOT Statewide Hazmat Coordinator	(503) 667-7442
ODOT Region 1 Hazmat Coordinator	(503) 731-8290
ODOT Region 2 Hazmat Coordinator	(503) 986-2647
ODOT Region 3 Hazmat Coordinator	(541) 957-3594
ODOT Region 4 Hazmat Coordinator	(541) 388-6186
ODOT Region 5 Hazmat Coordinator	(541) 963-1590
ODEQ Northwest Region Office	(503) 229-5263

A Appendix A – Site Specific Operational Plan

Contents:

Operational Plan: DFI D001200

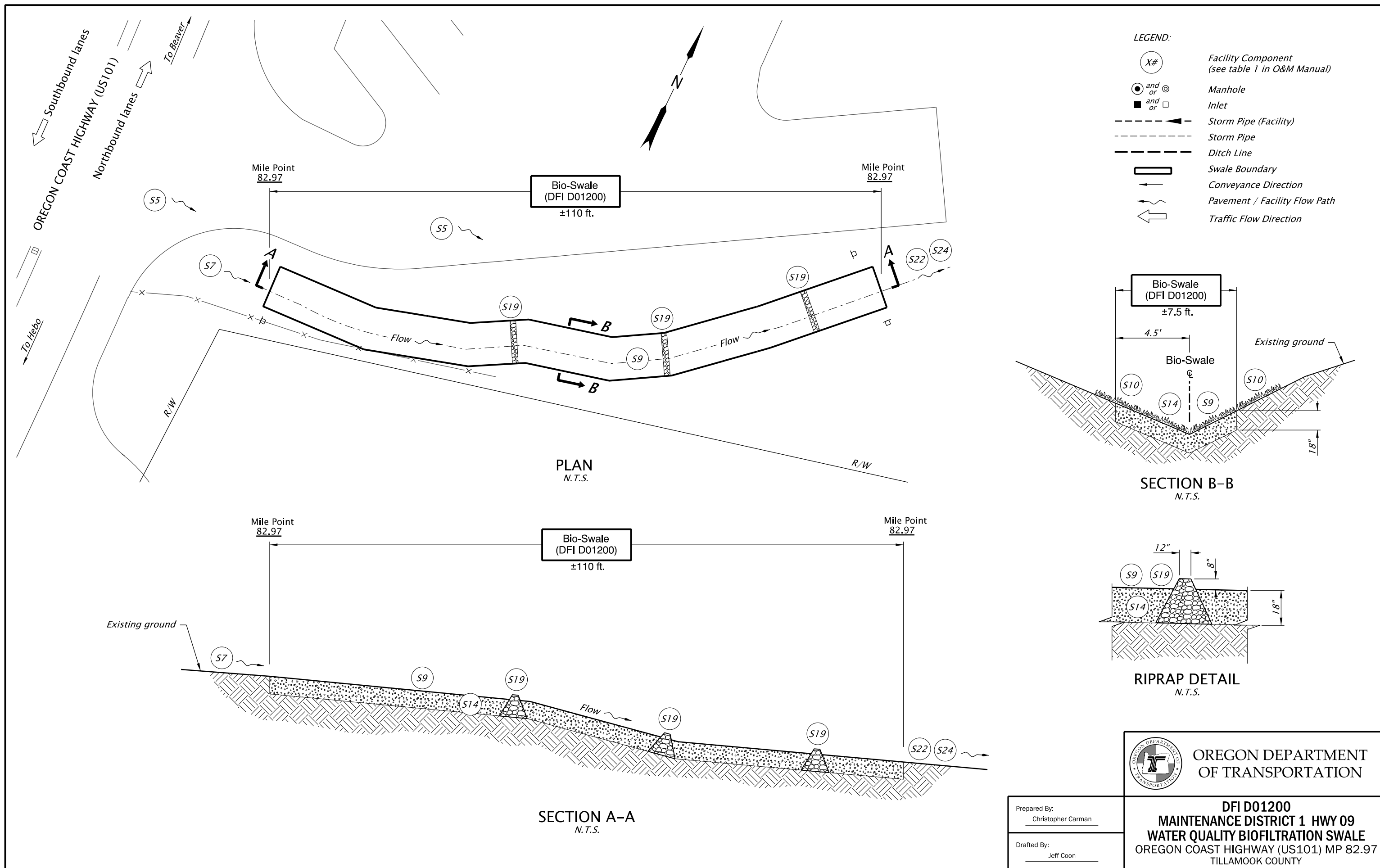

- LEGEND:**
- X# Facility Component (see table 1 in O&M Manual)
 - and ⊙ Manhole
 - and Inlet
 - Storm Pipe (Facility)
 - Storm Pipe
 - Ditch Line
 - Swale Boundary
 - Conveyance Direction
 - Pavement / Facility Flow Path
 - Traffic Flow Direction

	<p>OREGON DEPARTMENT OF TRANSPORTATION</p>
<p>Prepared By: Christopher Carman</p> <p>Drafted By: Jeff Coon</p>	<p>DFI D01200 MAINTENANCE DISTRICT 1 HWY 09 WATER QUALITY BIOFILTRATION SWALE OREGON COAST HIGHWAY (US101) MP 82.97 TILLAMOOK COUNTY</p>

Appendix B – Project Contract Plans

Contents:

Site Specific Subset of Project Contract Plan 52v-044

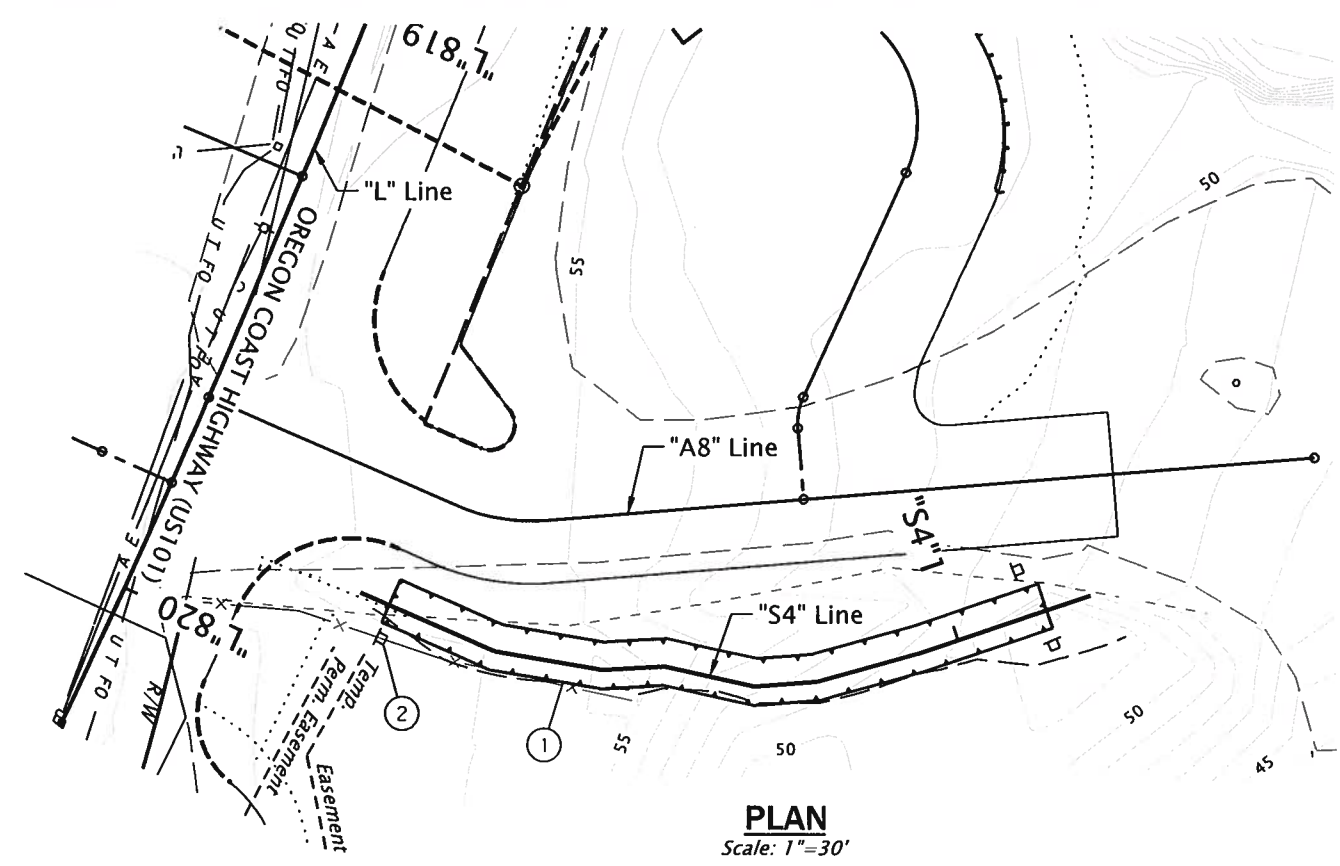

PLAN
Scale: 1"=30'

- ① Sta. "S4" 0+05.0 to Sta. "S4" 1+15.0
Construct Water Quality Biofiltration Swale No. 01200
General excavation - 50 cu. yds.
Water Quality Soil Mixture - 50 cu. yds.
Loose Riprap (Class 50) - 5 cu. yds.
- ② Install Stormwater Facility Marker
See dwg. RD399

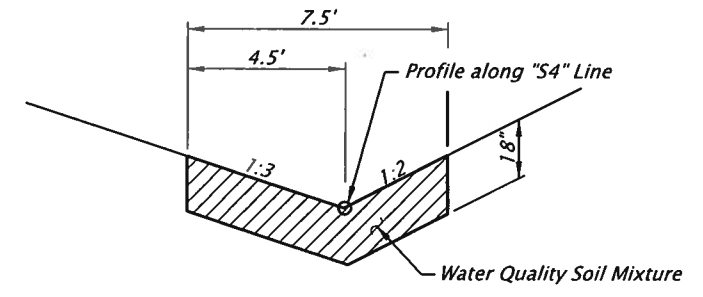

TYPICAL SECTION
Scale: 3/16"=1'-0"

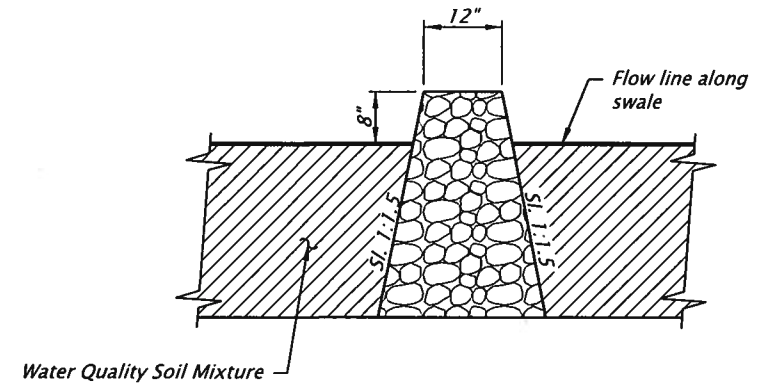

RIPRAP DETAIL
No Scale

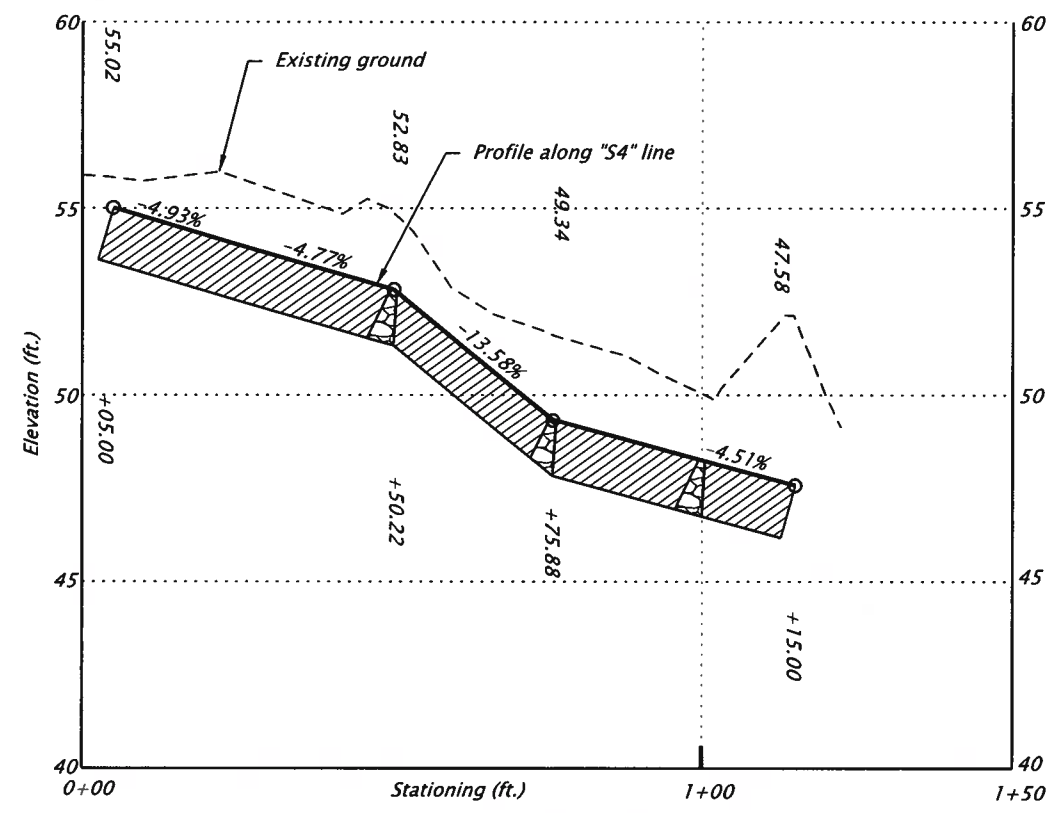

PROFILE "S4" LINE
Horiz. Scale: 1" = 30'
Vert. Scale: 1" = 5'

Note: Slopes shown as vertical to horizontal.

HWY: 09
M.P.: 82.97
UNIT FILE CODE N/A
DFI/TSSU NO. 01200

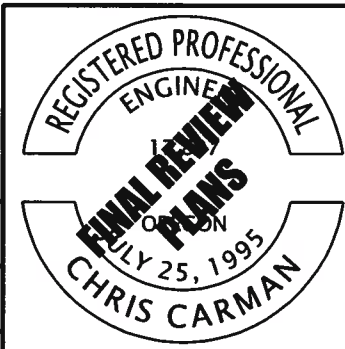

RENEWS: 12-31-2019

FINAL ELECTRONIC DOCUMENT
AVAILABLE UPON REQUEST

OREGON DEPARTMENT OF TRANSPORTATION	
US101: FARMER CREEK BRIDGE SEC. OREGON COAST HIGHWAY TILLAMOOK COUNTY	
Designer: Christopher Carman Drafter: Julie Rentz	Reviewer: Bruce Carmichael Checker: N/A
STORMWATER	
SHEET NO. HA03	