

OPERATION & MAINTENANCE MANUAL

DFI No. : D00764

**Facility Type: Water Quality
Biofiltration Swale**



September, 2017

1. Identification

Drainage Facility ID (DFI): **D00764**
Facility Type: Water Quality Biofiltration Swale
Construction Drawings: 46V-113
Location: District: 08
Highway No.: 001
Mile Post: 24.27; 24.29 (beg./end)
Description: This facility is located in the east side of northbound I-5. Access to the facility can be obtained along the shoulder of I-5 northbound.

2. Facility Contact Information

Contact the Engineer of Record, Region Technical Center, or Geo-Environmental's Senior Hydraulics Engineer for:

- Operational clarification
- Maintenance clarification
- Repair or restoration assistance

Engineering Contacts:

Region Technical Center Hydro Unit Manager

Or

Geo-Environmental Senior Hydraulics Engineer (503) 986-3365.

3. Construction

Engineer of Record: DeLanie Cutsforth – Region 3 Tech Center, White City, (541) 774-6326

Facility construction: 2016
Contractor: Hamilton Construction Co.

4. Storm Drain System and Facility Overview

A water quality swale is a flat-bottomed open channel designed to treat stormwater runoff from highway pavement areas. This type of facility is lined with grass. Treatment by trapping sedimentation occurs when stormwater runoff flows through the grass.

This facility is located along the northbound lane of I-5 (No. 001). Access for this facility is available from the eastern shoulder of northbound I-5. Stormwater enters the facility via roadway runoff and a drainage ditch located along the eastern side of northbound I-5. As the water flows north it is treated as it slows and spreads out within the swale before outfalling into an existing ditch.

A. Maintenance equipment access:

This facility can be accessed from the southbound I-5 (Hwy 001) shoulder.

B. Heavy equipment access into facility:

- Allowed (no limitations)
- Allowed (with limitations)
- Not allowed

C. Special Features:

- Amended Soils
- Porous Pavers
- Liners
- Underdrains

5. Facility Haz Mat Spill Feature(s)

The water quality biofiltration swale can be used to store a volume of liquid by blocking the facility outlet through use of sandbags.

6. Auxiliary Outlet (High Flow Bypass)

Auxiliary Outlets are provided if the primary outlet control structure can not safely pass the projected high flows. Broad-crested spillway weirs and over flow risers are the two most common auxiliary outlets used in stormwater treatment facility design. The auxiliary outlet feature is either a part of the facility or an additional storm drain feature/structure.

The auxiliary outlet feature for this facility is:

Designed into facility

Other

There are no auxiliary outlets built into this facility. In the event that flows exceed design flows the water will overtop the swale.

7. Maintenance Requirements

Routine maintenance table for non-proprietary stormwater treatment and storage/detention facilities have been incorporated into ODOT's Maintenance Guide. These tables summarize the maintenance requirements for ponds, swales, filter strips, bioslopes, and detention tanks and vaults. Special maintenance requirements in addition to the routine requirements are noted below when applicable.

The ODOT Maintenance Guide can be viewed at the following website:

<http://www.oregon.gov/ODOT/HWY/OOM/MGuide.shtml>

Maintenance requirements for proprietary structures, such as underground water quality manholes and/or vaults with filter media are noted in Appendix C when applicable.

The following stormwater facility maintenance table (See ODOT Maintenance Guide) should be used to maintain the facility outlined in this Operation and Maintenance Manual or follow the Maintenance requirements outlined in Appendix C when proprietary structure is selected below:

- Table 1 (general maintenance)
- Table 2 (stormwater ponds)
- Table 3 (water quality biofiltration swales)
- Table 4 (water quality filter strips)
- Table 5 (water quality bioslopes)
- Table 6 (detention tank)
- Table 7 (detention vault)
- Appendix C (proprietary structure)
- Special Maintenance requirements:

Note: Special maintenance Requirements Require Concurrence from ODOT SR Hydraulics Engineer.

8. Waste Material Handling

Material removed from the facility is defined as waste by the Department of Environment Quality (DEQ). Refer to the roadwaste section of the ODOT Maintenance Yard Environmental Management System (EMS) Policy and Procedures Manual for disposal options:

http://www.oregon.gov/ODOT/Maintenance/Documents/ems_manual.pdf

Contact any of the following for more detailed information about management of waste materials found on site:

ODOT Clean Water Unit	(503) 986-3008
ODOT Statewide Hazmat Coordinator	(503) 667-7442
ODOT Region 1 Hazmat Coordinator	(503) 731-8290
ODOT Region 2 Hazmat Coordinator	(503) 986-2647
ODOT Region 3 Hazmat Coordinator	(541) 957-3594
ODOT Region 4 Hazmat Coordinator	(541) 388-6186
ODOT Region 5 Hazmat Coordinator	(541) 963-1590
ODEQ Northwest Region Office	(503) 229-5263

Appendix A

Content:

- **Operational Plan and Profile Drawing(s)**

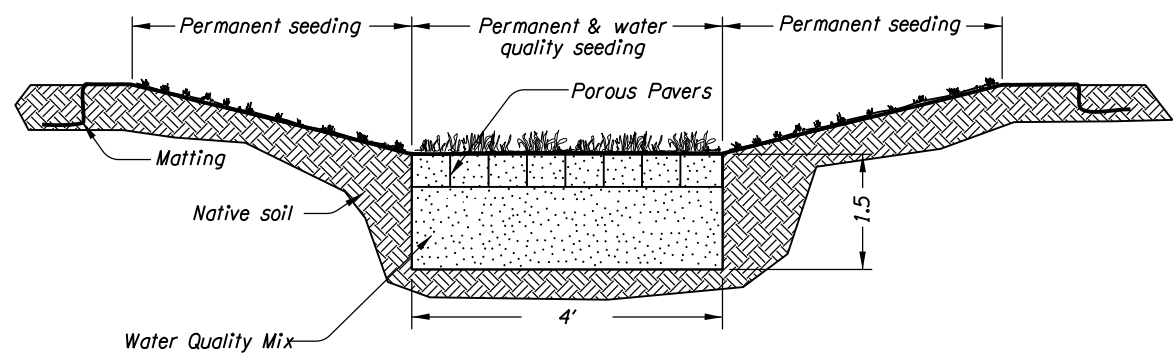
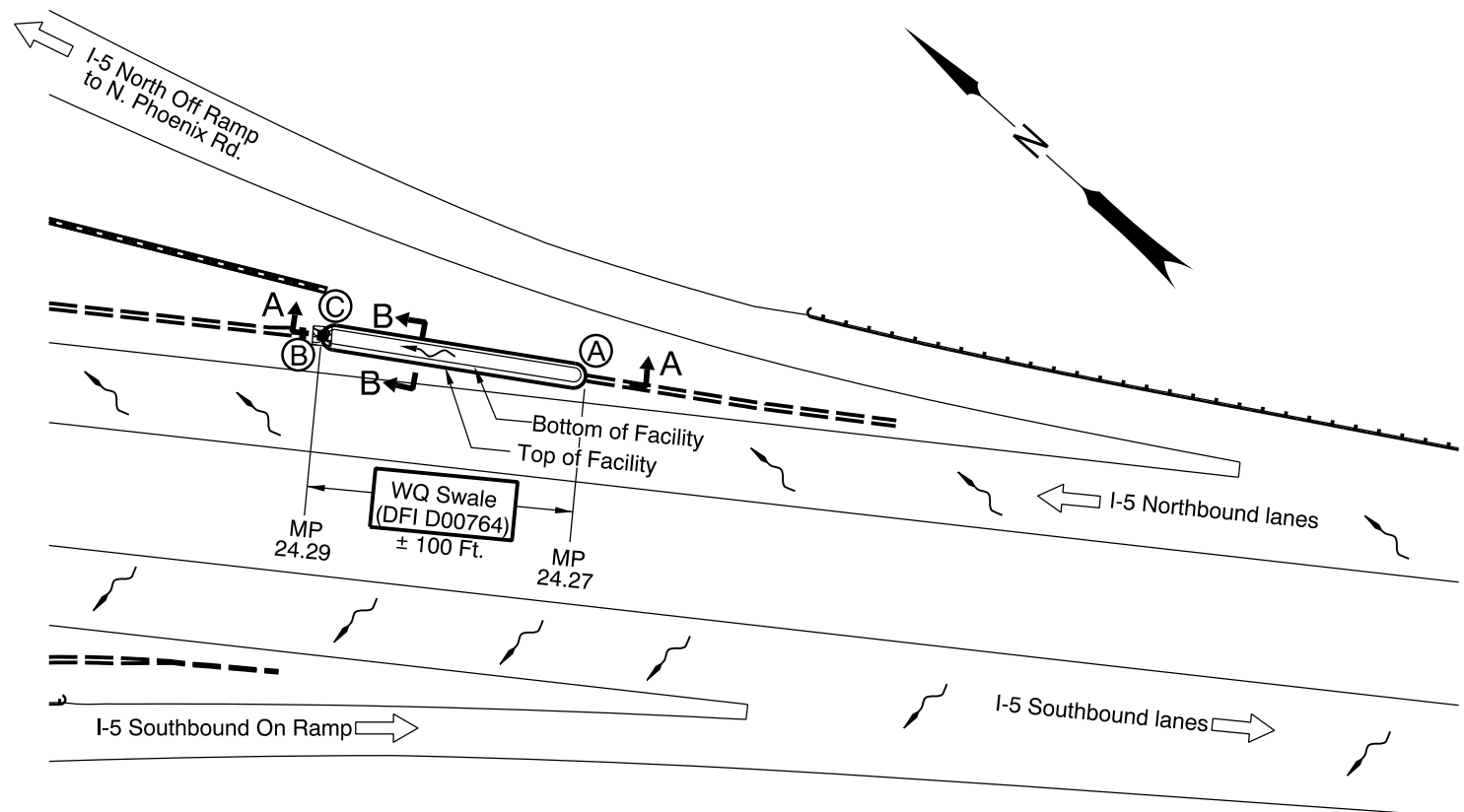

SECTION B-B
N.T.S.

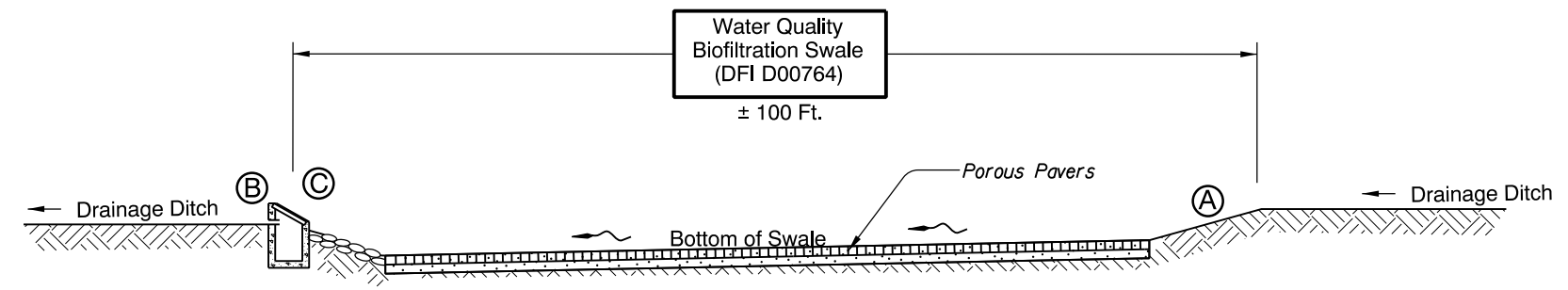

SECTION A-A
N.T.S.

- LEGEND:**
- (A) Swale Inlet w/Flow Spreader
 - (B) Swale Outlet
 - (C) Outlet Structure "G-2MA" Inlet
 - and ○ Manhole
 - and □ Inlet
 - - - Storm Pipe (Facility)
 - - - Storm Pipe
 - Conveyance Direction
 - ↪ Pavement / Facility Flow Path

OREGON DEPARTMENT OF TRANSPORTATION

Prepared By: T. BURRIER
 Drafted By: T. BURRIER

DFI D00764
MAINTENANCE DISTRICT 8 HWY 001
WATER QUALITY BIOFILTRATION SWALE
 HIGHWAY MP 24.27 TO 24.29
 JACKSON COUNTY

Appendix B

Content:

- **ODOT Project Plan Sheets**
 - *Cover/Title Sheet*
 - *Water Quality/Detention Plan Sheets*
 - *Other Details*

INDEX OF SHEETS	
SHEET NO.	DESCRIPTION
1	Title Sheet
1A	Index Of Sheets Cont'd.
1A-2, 1A-3	Standard Dwg. Nos.
1A-4	Layout Sheet

STATE OF OREGON
DEPARTMENT OF TRANSPORTATION

PLANS FOR PROPOSED PROJECT
PAVING, GRADING, DRAINAGE, STRUCTURES,
SIGNING & ROADSIDE DEVELOPMENT

**FFO-I-5: FERN VALLEY
INTERCHANGE, UNIT 2**

**PACIFIC HIGHWAY
JACKSON COUNTY
NOVEMBER 2013**

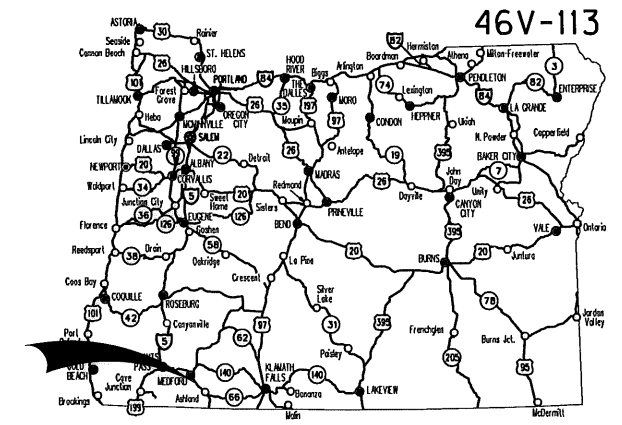

46V-113

Overall Length Of Project - 1.02 Miles

ATTENTION:
Oregon Law Requires You To Follow Rules
Adopted By The Oregon Utility Notification
Center. Those Rules Are Set Forth In
OAR 952-001-0010 Through OAR 952-001-0090.
You May Obtain Copies Of The Rules By Calling
The Center. (Note: The Telephone Number For
The Oregon Utility Center Is (503) 232-1987.)



**BEGINNING OF PROJECT
HPP-STP-S001(410)**

STA. "L" 1002+00 (M.P. 24.98)

**END OF PROJECT
HPP-STP-S001(410)**
STA. "NP" 74+00 (M.P. 1.21)

**END OF PROJECT
HPP-STP-S001(410)**

STA. "RVH" 381+27 (M.P. 11.05)

**BEGINNING OF PROJECT
HPP-STP-S001(410)**

STA. "RVH" 366+25 (M.P. 11.32)

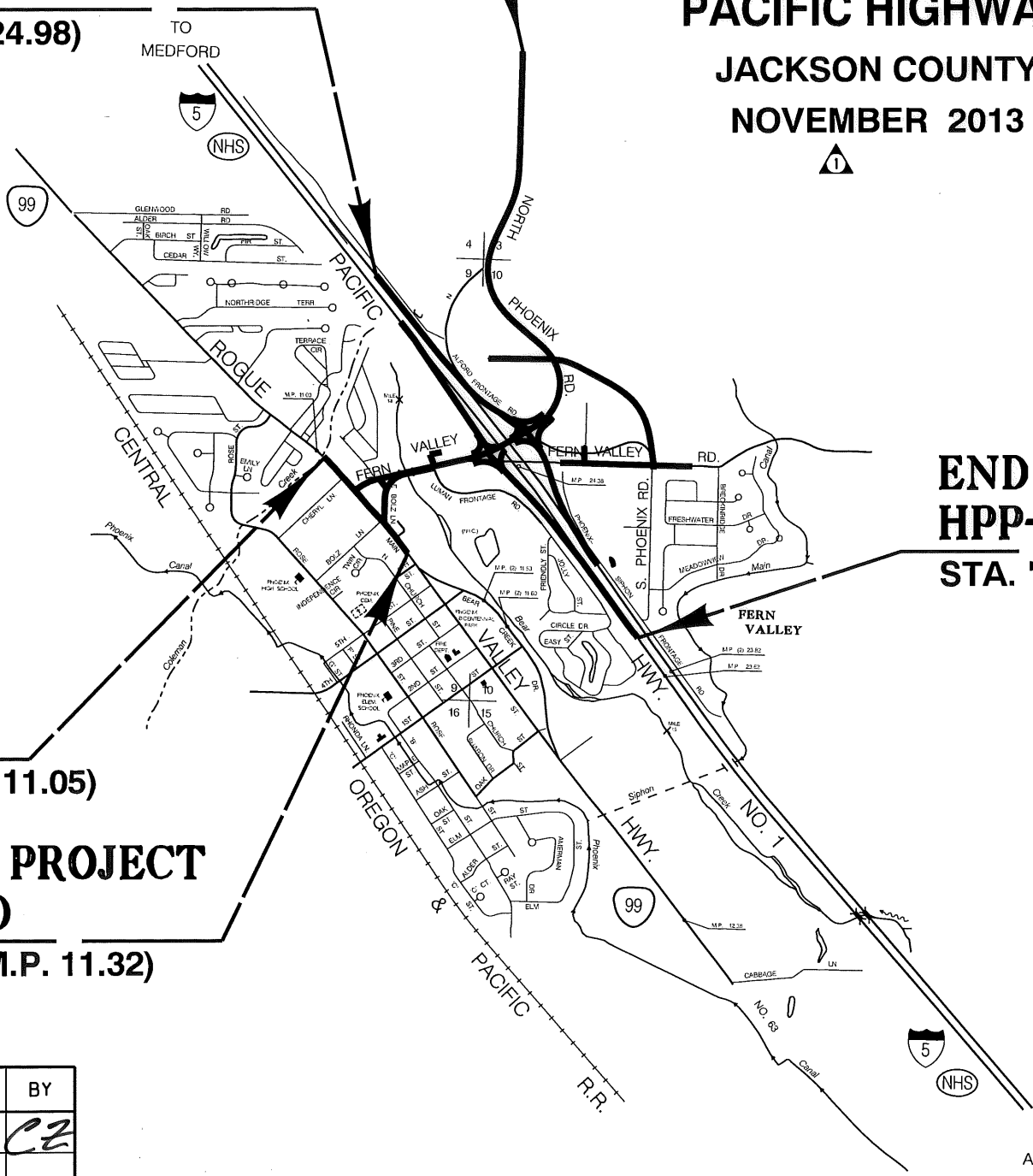

**END OF PROJECT
HPP-STP-S001(410)**

STA. "L" 1054+35 (M.P. 23.96)

No.	DATE	REVISIONS	BY
1	10-31-13	Bid date was October 2013	CZ

Sec. 03, T.38S, R. 1W, W.M.
Sec. 09, T.38S, R. 1W, W.M.
Sec. 10, T.38S, R. 1W, W.M.
Sec. 15, T.38S, R. 1W, W.M.

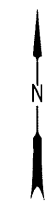

OREGON TRANSPORTATION COMMISSION
Pat Egan CHAIR
David Lohman COMMISSIONER
Mary F. Olson COMMISSIONER
Mark Frohnmoyer COMMISSIONER
Tammy Baney COMMISSIONER
Matthew L. Garrett DIRECTOR OF TRANSPORTATION

These plans were developed using ODOT design standards. Exceptions to these standards, if any, have been submitted and approved by the ODOT Chief Engineer or their delegated authority.

Approving Authority: *M. Thompson*
Signature & date 11-4-2013
MARK THOMPSON, TECH. CENTER MGR.
Print name and title
Chon. O.
Concurrence by ODOT Chief Engineer

FFO-I-5: FERN VALLEY INTERCHANGE, UNIT 2		
PACIFIC HIGHWAY JACKSON COUNTY		
FEDERAL HIGHWAY ADMINISTRATION	PROJECT NUMBER	SHEET NO.
OREGON DIVISION	HPP-STP-S001(410)	1

INDEX OF SHEETS, CONT'D.	
SHEET NO.	DESCRIPTION
② 1A-5	Intersection Layout Sheet Index (For Detail Sheets 2B-43 thru 2B-49)
1B	Prospective Staging Area
1B-2, 1B-3	Right of Way Hold-Outs
1C, 1C-2	Survey Control Sheet
2 thru 2A-41	Typical Sections
② 2B thru 2B-49	Details
2C thru 2C-13E	Traffic Control Plans
2D thru 2D-8	Pipe Data Sheet
2E thru 2E-5	Concrete Joint Layout
① 3 thru 15*	Alignment
3A thru 15A-2*	General Construction
3B thru 15B-2*	Drainage & Utilities
3C thru 15C-2*	Profiles
W1 thru W13	Waterline Plans
D1 thru D10	Waterline Details

*For a detailed list of sheets, see Plan Sheet Index on see sht. 1A-4

SHEET NO.	DESCRIPTION
GEO/HYDRO	
GA	Erosion Control Notes
GA-2 thru GA-7	Erosion Control Details
GA-8 thru GA-63	Erosion Control Plan
GH, GH-2	Bank Protection
GJ thru GJ-10	Stormwater

SHEET NO.	DESCRIPTION
LANDSCAPE	
GN thru GN-15	Planting Plan

SHEET NO.	DESCRIPTION
AESTHETIC	
2F thru 2F-25	Bridge Aesthetic Details

DRAWING NO.	DESCRIPTION
BRIDGE	
92015	General Layout and Index
GRAVITY WALL #22074	
92016	Plan and Elevation
GRAVITY WALL #21728	
92017	Plan and Elevation
GRAVITY WALL #21919	
92018	Plan and Elevation
BEAR CREEK BRIDGE #21382	
92019	Plan and Elevation
92020	General Notes
92021 thru 92023	Foundation Data Sheet
92024	Stage Construction
92025	Footing Plan
92026	Deck Plan
92027	Typical Deck Section
92028	Bulb I Girder Schedules
92029	Deck Elevations: Spans 1&2
92030 thru 92032	Bent 1, Bent 2 and Bent 3
92033	Bent Details
92034	Bearings
92035	Shearlug & Misc.
92036	Wingwalls
92037	Sign Support at Bent 2
92038	Barrier Notes and Misc. Details
92039	Temporary Precast Barriers
92040	Bridge End Pylon
92041	Bridge Monument
92042	Utility Detail
92043	Avista Gas Casing Installation
92044	Retaining Wall Design
92045	MSE Wall Design
92046	MSE Wall Design cont.
MSE WALL 1 #21729	
92047	Plan and Elevation
92048	Foundation Data
92049	MSE Wall Design
92050	Combination Rail Coping Detail
92051	Coping Mount Sign Support
MSE WALL 2 #21730	
92052	Plan and Elevation
92053	Foundation Data
92054	MSE Wall Design
92055	Coping Mount Sign Support

DRAWING NO.	DESCRIPTION
BRIDGE (cont'd)	
I-5 INTERCHANGE BRIDGE #21383	
92056	Plan and Elevation
92057	General Notes
92058 thru 92061	Foundation Data Sheet
92062	Footing Plan
92063	Deck Plan
92064	Typical Deck Section
92065	Deck Elevations: Spans 1 & 2
92066 & 92067	Prestressed Box Girder Details (1&2)
92068	Bent 1
92069	Bent 2
92070	Bent 3
92071	Bent Details
92072	Drilled Shaft Detail
92073	Bearing Pad
92074	Wingwalls
92075	Rail Monument Layout
92076 & 92077	Pedestrian Corridor Monuments
92078 & 92079	Bridge Rail Monuments
92080	Protective Screening Layout
92081	Post Details (Protective Screening)
92082	Retaining Wall Layout
92083 & 92084	MSE Wall Design
MSE WALL 3 #21731	
92085	Plan and Elevation
92086	Foundation Data
92087	MSE Wall Design
92088	Type F Rail Coping Detail

For List Standard Dwg. Nos., see shts. 1A-2 & 1A-3

No.	DATE	REVISIONS	BY
①	10-21-13	Added sheet 15A-2	CZ
②	04-03-15	Added sheets 1A-5, 2B-43 thru 2B-49.	CZ

Standard Drawings located on the web at:
http://www.oregon.gov/ODOT/HWY/ENGSERVICES/standard_drawings_home.shtml

SHEET NO.	DESCRIPTION
PERMANENT PAVEMENT MARKINGS	
ST & ST-2	Striping Details
ST-3 thru ST-16	Striping Plan

SHEET NO.	DESCRIPTION
PERMANENT SIGNING	
S-14146 thru S-14171	Signing Plans
S-14172 thru S-14184	Signing Details
S-14185 thru S-14196	Sign & Post Data Table

SHEET NO.	DESCRIPTION
PERMANENT SIGN SUPPORT STRUCTURES	
SIGN STRUCTURE #21718	
S-14198	Cantilever Sign Support
SIGN STRUCTURE #21719	
S-14199	Cantilever Sign Support
SIGN STRUCTURE #21720	
S-14200	Cantilever Sign Support
SIGN STRUCTURE #21721	
S-14201	Cantilever Sign Support
SIGN STRUCTURE #21722	
S-14202	Cantilever Sign Support
SIGN STRUCTURE #21723	
S-14203	Truss Type Sign Bridge
SIGN STRUCTURE #21724	
S-14204	Truss Type Sign Bridge
SIGN STRUCTURE #21725	
S-14205	Cantilever Sign Support

SHEET NO.	DESCRIPTION
ILLUMINATION	
I-02138 thru I-02151	Illumination Plans

SHEET NO.	DESCRIPTION
TRAFFIC SIGNALS	
16976 thru 17037, 17326	Signal Plans
17053	Din Rail Section and Details
17054	Din Rail Assembly
ITS-1410, ITS-1411	Fiber Optic Cable Splice Diagram
ITS-1412	Handhole and Traffic Cabinet Details
ITS-1413	Camera Cabinet Details
ITS-1414 thru ITS-1416	Traffic Camera Pole (3 sheets)

FFO-1-5: FERN VALLEY INTERCHANGE, UNIT 2		
PACIFIC HIGHWAY JACKSON COUNTY		
FEDERAL HIGHWAY ADMINISTRATION	PROJECT NUMBER	SHEET NO.
OREGON DIVISION	HPP-STP-S001 (410)	1A

Standard Dwg. Nos.

- RD100 - Mailbox Support
- RD101 - Mailbox Installation
- RD150 - Slope Rounding

- RD300 - Trench Backfill, Bedding, Pipe Zone
- RD302 - Street Cut
- RD306 - Concrete Encasement, Cradle, And Cap Details
- RD312 - Subsurface Drain
- RD316 - Sloped Ends For Metal Pipe
- RD317 - Culvert Embankment Protection
- RD318 - Sloped Ends For Concrete Pipe
- RD319 - Miscellaneous Culvert Details
- RD320 - Paved End Slope For Culverts 60" Maximum Pipe Size
- RD322 - Safety End Section For Metal Pipe
- RD324 - Safety End Section For Concrete, PVC, HDPE & Polypropylene Pipe
- RD326 - Coupling Bands
- RD327 - Coupling Bands For Corrugated Metal Pipe Types F, J, & K
- RD335 - Standard Storm Sewer Manhole
- RD336 - Standard Storm Sewer Manhole
- RD342 - Shallow Manholes
- RD344 - Standard Manhole Base Section
- RD346 - Large Precast Manhole
- RD348 - Manhole With Inlet
- RD356 - Manhole Covers And Frames
- RD358 - Manhole Slope Protectors
- RD360 - Manhole Frame Adjustment
- RD364 - Concrete Inlets Type G-1, G-2, G-2M, & G-2MA
- RD366 - Concrete Inlets Type CG-1, CG-2 and Curb Inlet Channel
- RD370 - Ditch Inlet Type D
- RD371 - Concrete Inlet Base Type CG-3
- RD372 - Concrete Inlet Top, Option 1, Type CG-3
- RD373 - Concrete Inlet Top, Option 2, Type CG-3
- RD374 - Area Drainage Basin Or Field Inlet
- RD376 - Miscellaneous Drainage Structures Siphon Box, Inlet Cap & Inlet Adjustment

- RD380, RD382, RD384, RD386 - Pipe Fill Height Tables
- RD388 - Fill Height Tables For PVC Pipe
- RD390 - Fill Height Tables For Corrugated HDPE Pipe
- RD391 - Fill Height Tables For Steel Reinforced HDPE Pipe
- RD393 - Fill Height Tables For Polypropylene Pipe
- RD398 - Culvert ID Marker
- RD399 - Stormwater Treatment and Storage Facility Field Markers

- RD400, RD405, RD410, RD415, RD420, RD425, RD430, RD435, RD440, RD445, RD450, RD470 - Guardrail

- RD500 - Precast Concrete Barrier Pin and Loop Assembly
- RD505 - Concrete Barrier Cast-In-Place
- RD516 - Securing Concrete Barrier to Roadway
- RD530 - Guardrail Transition to Concrete Barrier
- RD545 - Precast Tall (42") Concrete Barrier
- RD550 - Cast-In-Place Tall Concrete Barrier Transition to Bridge Rail Type "F"
- RD570 - Guardrail Transition to Tall Concrete Barrier

- RD610 - Asphalt Pavement Details

- RD700, RD701 - Curbs
- RD705 - Islands
- RD706 - Traffic Separators And Transitions
- RD710 - Accessible Route Islands
- RD715 - Approaches And Non-Sidewalk Driveways
- RD720 - Sidewalks
- RD735 - Curb Line Sidewalk Driveways or Alleys
- RD740 - Separated Sidewalk Driveways - Local Jurisdictions
- RD755 - Sidewalk Ramp Details
- RD770 - Pedestrian Handrail
- RD771 - Pedestrian Handrail Details

- RD810 - Barbed and Woven Wire Fences
- RD815 - Chain Link Fence
- RD820 - Fence Gates

- RD1000 - Construction Entrances
- RD1005 - Check Dams
- RD1010 - Inlet Protection (Type 1, 2 and 3)
- RD1015 - Inlet Protection (Type 4) Biofilter Bags
- RD1020 - Inlet Protection (Type 5) Masonary/Aggregate
- RD1025 - Sediment Barrier (Type 1)
- RD1040 - Sediment Fence
- RD1055 - Matting
- RD1060 - Tire Wash Facility (Type 1)

- BR139 - Expansion Joint with Preformed Compression Seals
- BR165 - Bridge End Panel

- BR200 - Concrete Bridge Rail Type F
- BR203 - Transition Concrete Bridge Rail to Guardrail
- BR216 - Sidewalk Mounted Combination Bridge Rail
- BR223 - Combination Rail
- BR240 - Protective Fencing
- BR241 - Protective Fencing Details - 1
- BR290 - 3'-6" Type "F" Rail

- BR300 - Bulb-I Girders
- BR350 - Temporary Diaphragm Beam for Prestressed Concrete Girders

- BR425 - 33" Precast Prestressed Box
- BR445 - Precast Prestressed Boxes and Slabs Details

- BR720 - Standard Gravity Retaining Wall Details
- BR760 - Moment Slab on MSE Wall

- BR970 - Luminaire Base on Structures with Mounting Details

Cont'd., see next sht.

FFO-I-5: FERN VALLEY INTERCHANGE, UNIT 2 PACIFIC HIGHWAY JACKSON COUNTY		
FEDERAL HIGHWAY ADMINISTRATION	PROJECT NUMBER	SHEET NO.
OREGON DIVISION	HPP-STP-S001 (410)	1A-2

Standard Drawings located on the web at:
http://www.oregon.gov/ODOT/HWY/ENGSERVICES/standard_drawings_home.shtml

Standard Dwg. Nos. cont'd.

- TM200 - Sign Installation Details
- TM201 - Miscellaneous Sign Placement Details
- TM204 - Flag Board Mounting Detail
- TM206 - Sign Bracing Details
- TM211, TM212 - Signing Details
- TM220 - Multi-Post Installations with Auxiliary Signs
- TM221 - Signing Details Milepost Markers
- TM222 - Installation Details Milepost Marker Posts
- TM223 - Conventional Roads Directional Sign Layout Street Name Signs
- TM224 - Signing Details Directional Sign Layout
- TM225 - Exit Number & Gore Signing Details
- TM230, TM231, TM232, TM233 - Mounting Details For Removable Legend

- TM450 - Mast Arm Pole Details
- TM452 - Strain Pole Details
- TM453 - Stabilizer Details
- TM455 - Temporary Signal Details
- TM457 - Vehicle, Ped. Signal & Push Button Mounting Details
- TM458 - Pedestrian Ramp Placement Details
- TM460 - Vehicle Signal Details
- TM462 - Adjustable Signal Head Mounting Details
- TM463 - Spanwire Mounting Details
- TM465 - Overhead Sign, Fire Preemption & Photoelectronic Details
- TM467 - Ped. Signal And Ped. Push Button Details
- TM470 - Color Code Charts
- TM472 - Traffic Signal Junction Boxes
- TM475, TM478 - Loop Details
- TM480 - Loop Entrance Details
- TM482 - Controller Cabinet And Foundation Details
- TM485 - Service Cabinets And Service Cabinet Wiring Details
- TM488 - Terminal Cabinet Detail

- TM500, TM501, TM502, TM503 - Pavement Marking Standard Details
- TM517 - Recessed Pavement Markers
- TM521 - Durable Pavement Markings Method "B" Extruded & Method "F" Spray
- TM524 - Durable Pavement Markings Method "E" Non-Profile Wet Weather
- TM530 - Intersection Pavement Markings
- TM531 - Turn Arrow Marking Details
- TM539 - Median And Left Turn Channelization Details
- TM547 - Freeway Entrance Ramp Pavement Markings
- TM551 - Freeway Exit Ramp Pavement Markings
- TM560, TM561 - Alignment Layout
- TM570 - Traffic Delineators
- TM571 - Traffic Delineators Steel Post Details
- TM575 - Traffic Delineator Installation For Freeways
- TM576 - Traffic Delineator Installation For Non-Freeways
- TM577 - Traffic Delineator Installation For Special Applications

- TM600, TM601 - Multi-Post Breakaway Sign Supports
- TM602 - Triangular Base Breakaway Multi-Direction Slip Base
- TM614, TM615, TM616, TM617, TM618, TM619, TM620 - Truss Type Sign Bridge
- TM622, TM623, TM624, TM625, TM626, TM627 - Monotube Cantilever Sign Support
- TM629, TM630 - Slip Base & Fixed Base Luminaire Supports
- TM650, TM651, TM652, TM653 - Traffic Signal Supports
- TM670 - Wood Post Sign Supports
- TM671 - 3 Second Gust Wind Speed Isotach
- TM675 - Extruded Aluminum Panels
- TM676 - Sign Attachments
- TM677 - Sign Mounts
- TM678 - Secondary Sign Mounting Details
- TM679 - Signal Mast Arm Street Name Sign Mounts
- TM680 - Signal Pole Mounts
- TM681 - Perforated Steel Square Tube (PSST) Sign Support Installation
- TM687 - Perforated Steel Square Tube (PSST) Anchor Foundation
- TM688 - Perforated Steel Square Tube (PSST) Slip Base Foundation

- TM800 - Tables, Abrupt Edge And PCMS Details
- TM810 - Temporary Reflective Pavement Markers
- TM820 - Temporary Barricades
- TM821 - Temporary Sign Supports
- TM830 - Temporary Concrete Barrier And Rumble Strips
- TM831 - Temporary Impact Attenuators
- TM840 - Closure Details
- TM841 - Intersection Work Zone Details
- TM842 - Signalized Intersection Details
- TM843 - Multi-Lane Signalized Intersection Details
- TM844 - Temporary Pedestrian Access Routing
- TM850 - 2-Lane, 2 Way Roadways
- TM851, TM852 - Non-Freeway Multi-Lane Sections
- TM860, TM861, TM862 - Freeway Sections
- TM870 - Bridge Construction
- TM871 - Blasting Zones

FFO-1-5: FERN VALLEY INTERCHANGE, UNIT 2 PACIFIC HIGHWAY JACKSON COUNTY		
FEDERAL HIGHWAY ADMINISTRATION	PROJECT NUMBER	SHEET NO.
OREGON DIVISION	HPP-STP-S001 (410)	1A-3

Standard Drawings located on the web at:
http://www.oregon.gov/ODOT/HWY/ENGSERVICES/standard_drawings_home.shtml

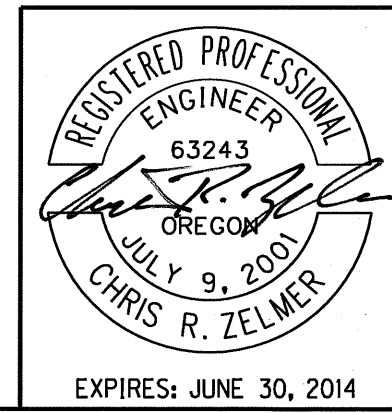
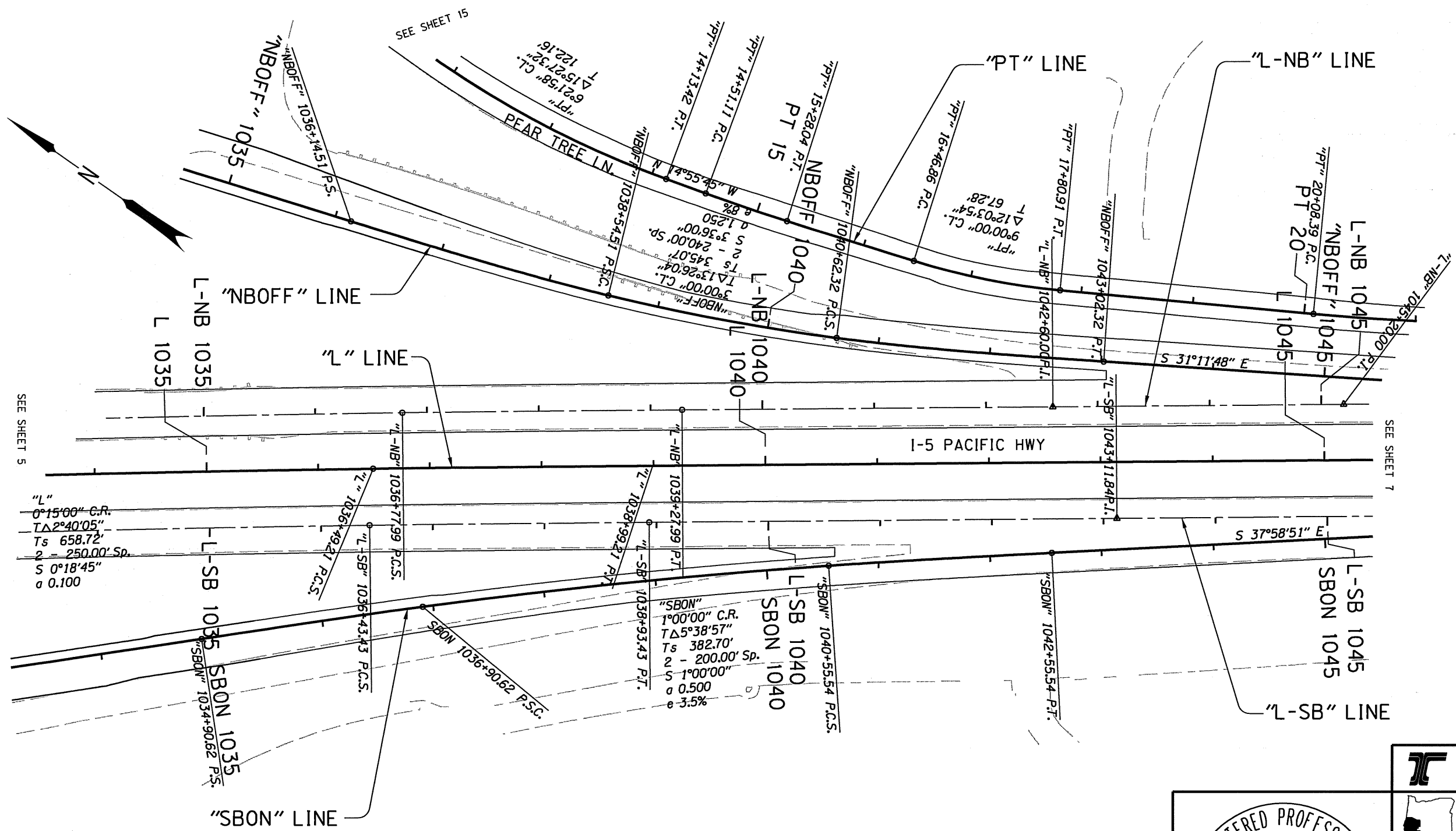

OREGON DEPARTMENT OF TRANSPORTATION	
REGION 3 - TECHNICAL CENTER	
FFO-1-5: FERN VALLEY INTERCHANGE, UNIT 2 PACIFIC HIGHWAY JACKSON COUNTY	
Designed By - Roy Blower Reviewed By - Rich Coffel Drafted By - David Knox	
ALIGNMENT	SHEET NO. 6

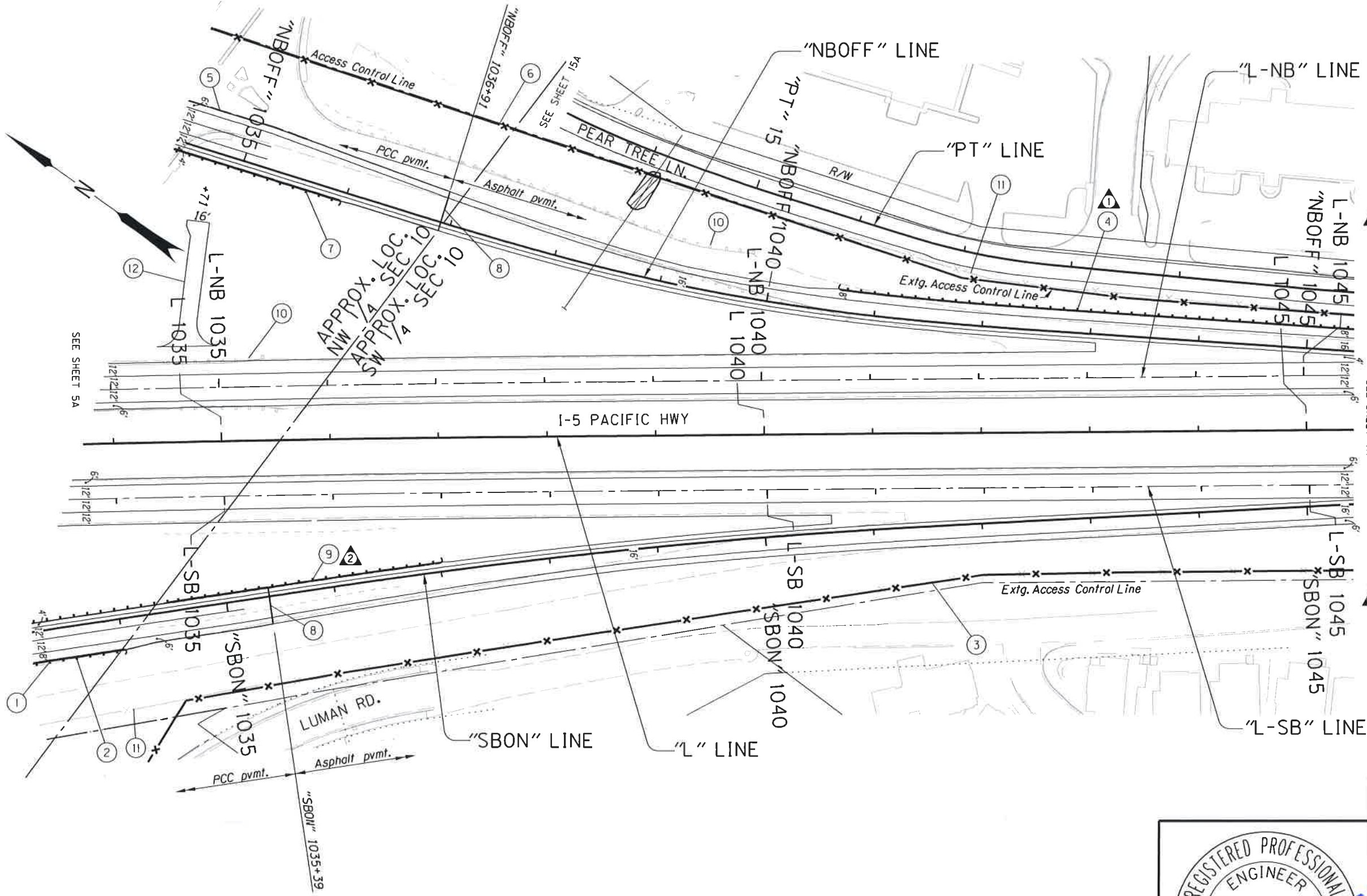

- ① See sht. 10A-2, note 14
Const. guardrail (Type 2A)
Inst. end piece (Type B)
Const. anchor - 2 (Type 1 mod.)
- ② See sht. 5A-2, note 17
Const. P.C. conc. drainage curb
- ③ See sht. 10A-2, note 9
Const. Type 2 fence
- ④ Sta. "NBOFF" 1040+66.67, Lt. to
Sta. "L-NB" 1050+58.89, Lt.
Const. guardrail - 837.5' (Type 2A)
Inst. end piece (Type B)
Const. anchor - 2 (Type 1 mod.)
- ⑤ See sht. 5A-2, note 35
Const. low profile mountable curb
- ⑥ See sht. 5A-2, note 36
Const. Type 2 fence
- ⑦ See sht. 5A-2, note 34
Sta. "NP" 30+32.63, Rt. to
Sta. "NBOFF" 1035+94.42, Rt.
Const. guardrail (Type 2A)
Const. guardrail terminal, non-flared - 37.5'
Flare rate=0, W=1', E=0'
Test level 3
- ⑧ Const. PCC to HMAC transition panel
(For details, see sht. 2B-19)
- ⑨ See sht. 5A-2, note 18
Sta. "SRF" 601+50.00, Lt. to
Sta. "SBON" 1036+99.90, Lt.
Const. guardrail (Type 2A)
Inst. end piece (Type B)
Const. anchor (Type 1 mod.)

- ⑩ Remove extg. guardrail - 850'
- ⑪ Remove extg. fence - 1875'
- ⑫ Const. approach
(For details, see sht. GJ-3)

No Work Area shown thus:

No.	DATE	REVISIONS	BY
①	02-27-17	Revised Note 4 (Revised guardrail note)	CZ
②	02-27-17	Revised Note 9, deleted guardrail terminal	CZ



EXPIRES: JUNE 30, 2014

OREGON DEPARTMENT OF TRANSPORTATION

REGION 3 - TECHNICAL CENTER

FFO-I-5: FERN VALLEY INTERCHANGE, UNIT 2
PACIFIC HIGHWAY
JACKSON COUNTY

Designed by - Roy Blower
Reviewed by - Rich Coffel
Drafted By - Judy Hardin

GENERAL CONSTRUCTION

SHEET NO. **6A**

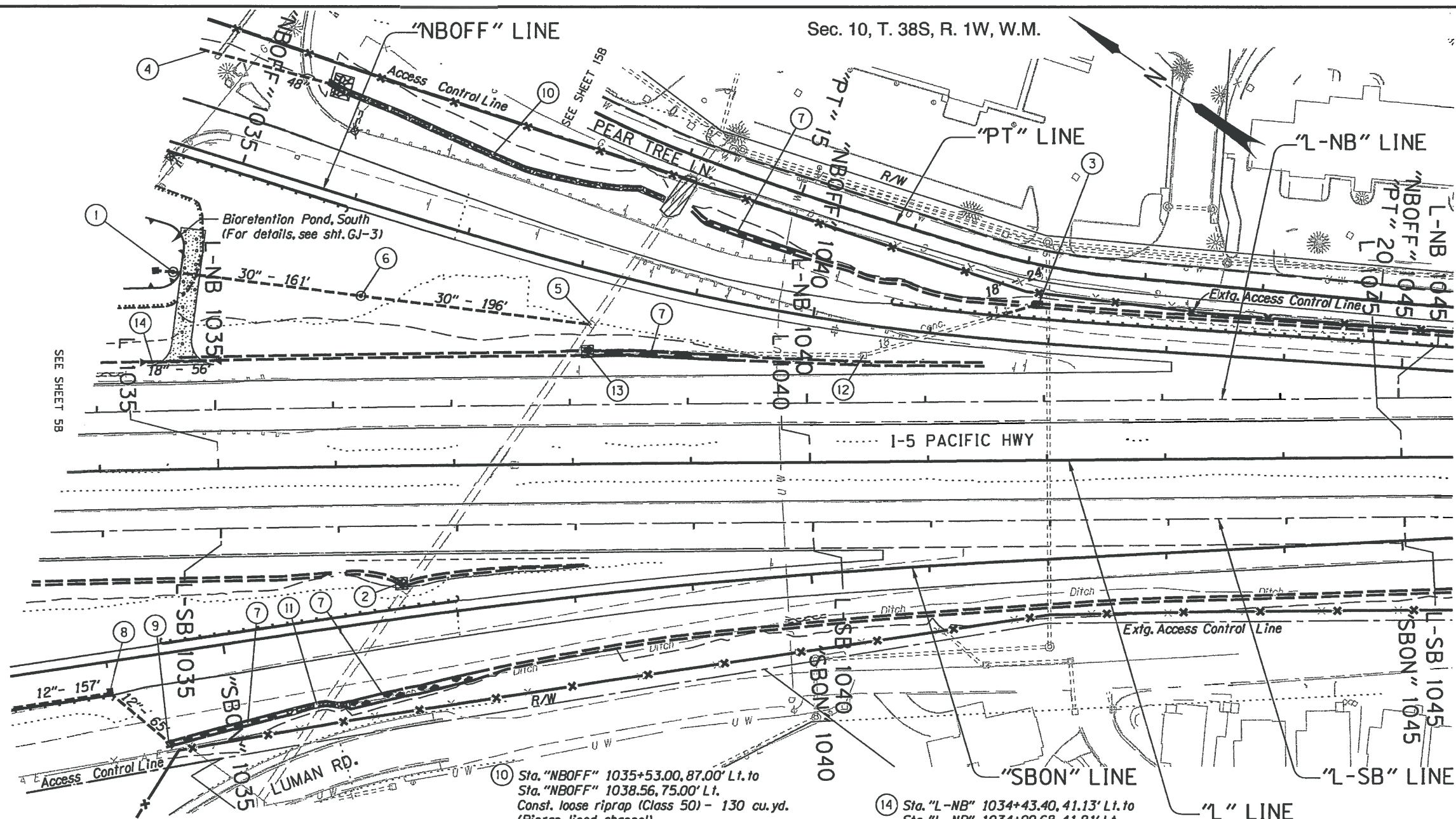

- ① Sta. "L-NB" 1034+66.24, 117.15' Lt.
Const. manhole 60" dia.
F.L.=1476.41
(For details, see sht. GJ-3)
- ② Sta. "L-SB" 1036+56.45, 54.30' Rt.
Const. loose riprap (Class 50) - 9 cu.yd.
Riprap geotextile - 11 sq.yd.
- ③ Sta. "NBOFF" 1041+85.63, 31.7' Lt.
Connect to extg. culv. pipe
Const. conc. collar
Const. type "G-2MA" inlet
Inst. 18" storm sew. pipe - 24'
5' depth
S=1.00%
Const. loose riprap (Class 50) - 6 cu.yd.
(Loose riprap pad)
Riprap geotextile - 12 sq.yd.
Gr.=1476.78
F.L.=1474.04 Lt.
F.L.=1473.82 Rt.
(For details, see sht. 2B)
(See dwg. no. RD306)
- ④ See sht. 5B-3, note 29
- ⑤ Sta. "L-NB" 1038+18.29, 67.63' Lt.
Connect to extg. structure
Adjust inlet
Inst. 30" storm sew. pipe - 196'
10' depth
S=0.49%
F.L.=1474.00
(See dwg. no. RD376)
- ⑥ Sta. "L-NB" 1036+24.65, 94.24' Lt.
Const. manhole 60" dia.
Inst. 30" storm sew. pipe - 161'
10' depth
S=0.88%
Rim=1481.39
F.L.=1474.97 (30" thru)
- ⑦ Const. water quality swale
(For details, see sht. GJ-9)

- ⑧ Sta. "SBON" 1033+99.50, 28.00' Rt.
Const. type "G-2" inlet
Inst. 12" storm sew. pipe - 157'
5' depth
S=3.94%
Gr.=1484.45
F.L.=1479.66 (12" thru)
- ⑨ Sta. "SBON" 1034+42.50, 75.00' Rt.
Inst. 12" storm sew. pipe - 65'
5' depth
S=6.75%
Const. sloped end section, Rt.
Const. paved end slope, Rt.
Const. loose riprap (Class 50) - 5 cu.yd.
(Loose riprap pad)
Riprap geotextile - 10 sq.yd.
F.L.=1475.31
(For details, see sht. 2B)

- ⑩ Sta. "NBOFF" 1035+53.00, 87.00' Lt. to
Sta. "NBOFF" 1038.56, 75.00' Lt.
Const. loose riprap (Class 50) - 130 cu.yd.
(Riprap lined channel)
Riprap geotextile - 170 sq.yd.
(For details, see sht. 2B-4)
- ⑪ Sta. "SBON" 1035+45.40, 65.4' Rt. to
Sta. "SBON" 1035+99.10, 66.75' Rt.
Const. loose riprap (Class 50) - 25 cu.yd.
(Riprap lined channel)
Riprap geotextile - 32 sq.yd.
(For details, see sht. 2B-4)
- ⑫ Sta. "L-NB" 1040+48.00, 40.00' Lt.
Adjust inlet to finish grade
- ⑬ Sta. "L-NB" 1038+15.00, 46.27' Lt.
Connect to extg. storm sew. pipe
Const. type "G-2MA" inlet
Const. loose riprap (Class 50) - 9 cu.yd.
(Loose riprap pad)
Riprap geotextile - 11 sq.yd.
Gr.=1476.30
F.L.=1472.82

- ⑭ Sta. "L-NB" 1034+43.40, 41.13' Lt. to
Sta. "L-NB" 1034+99.68, 41.21' Lt.
Inst. 18" culv. pipe - 56'
5' depth
S=0.57%
Const. sloped end section - 2
Const. paved end slope, Lt. & Rt.
F.L.=1474.68 Lt.
F.L.=1475.00 Rt.

Remove or abandon extg. pipe shown thus:

Remove extg. inlet shown thus:

Remove extg. manhole shown thus:

No Work Area shown thus:

Notes:
 1. Station/Offset/Elevation callouts for type "CG-2" and "CG-3" inlets are to top face of curb.
 2. Station/Offset/Elevation callouts for type "G-2" inlets are to back of grate.
 3. Station/Offset/Elevation callouts for type "G-2MA" inlets and manholes are to center of structure.
 4. Top of curb (T.C.) and Top of Grate (Gr.) elevations are approximate. (T.C.) and (Gr.) elevations shall match finish grade surface at inlet.

Construct Paved End Slope (07/19/16)

OREGON DEPARTMENT OF TRANSPORTATION	
REGION 3 - TECHNICAL CENTER	
FFO-I-5: FERN VALLEY INTERCHANGE, UNIT 2 PACIFIC HIGHWAY JACKSON COUNTY	
Designed By - Roy Blower Reviewed by - Rich Coffel Drafted By - Judy Hardin	
DRAINAGE & UTILITIES	SHEET NO. 6B

"L-NB" LINE

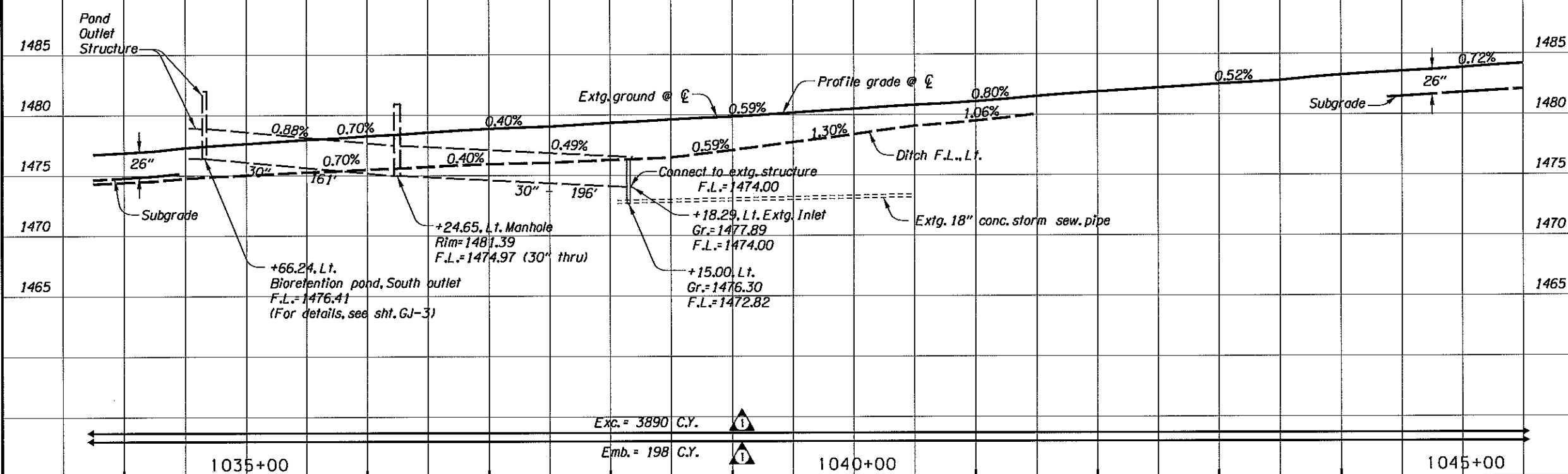

"L-SB" LINE

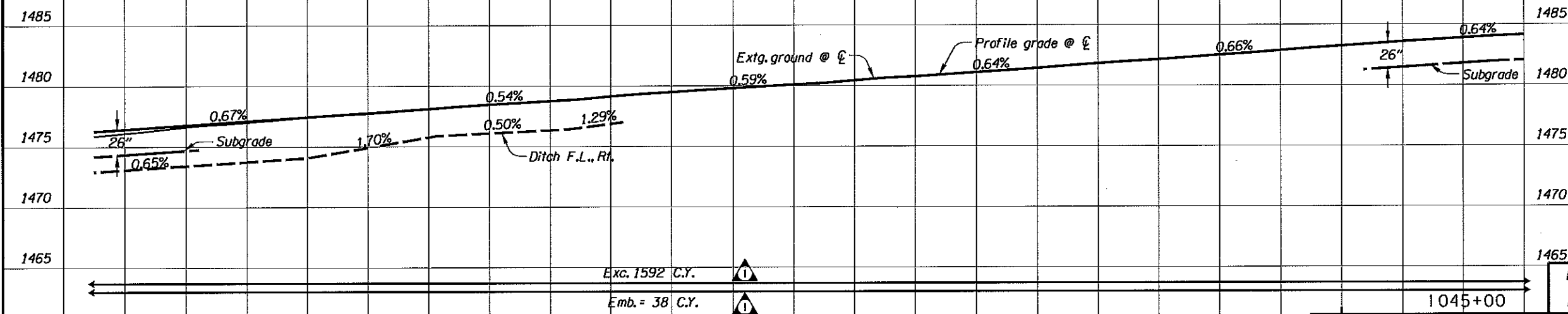

No.	DATE	REVISIONS	BY
1	01-27-14	Revised Exc. and Emb. quantities	CZ

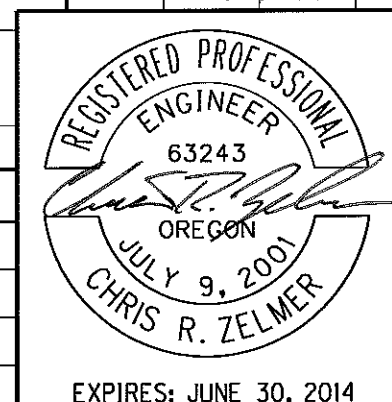

OREGON DEPARTMENT OF TRANSPORTATION

REGION 3 - TECHNICAL CENTER

FFO-1-5: FERN VALLEY INTERCHANGE, UNIT 2
PACIFIC HIGHWAY
JACKSON COUNTY

Design Team Leader - Chris Zelmer
Designed By - Roy Blower
Drafted By - Judy Hardin

PROFILE

SHEET NO. 6C

MODIFIED MANHOLE WITH OVERFLOW CAGE TOP
(not to scale)

Notes:

1. All metal parts corrosion resistant.
2. Provide maintenance access by welding 4 cross bars to vertical bars as shown. Hinge upper ends with bolted flanges and provide locking mechanism on lower end. Locate ladder steps directly below.
3. Place 4 hook clamps over lower steel bar. Anchor to manhole lid.
4. Construct overflow cage with 3/4"x 4" square edge steel bars. Weld all joints.
5. Hot-dip galvanize overflow cage and all steel parts after fabrication.
6. Use galvanized or stainless steel for all fasteners and hardware.
7. To be accompanied by drg. nos. RD336, RD346 & RD356.

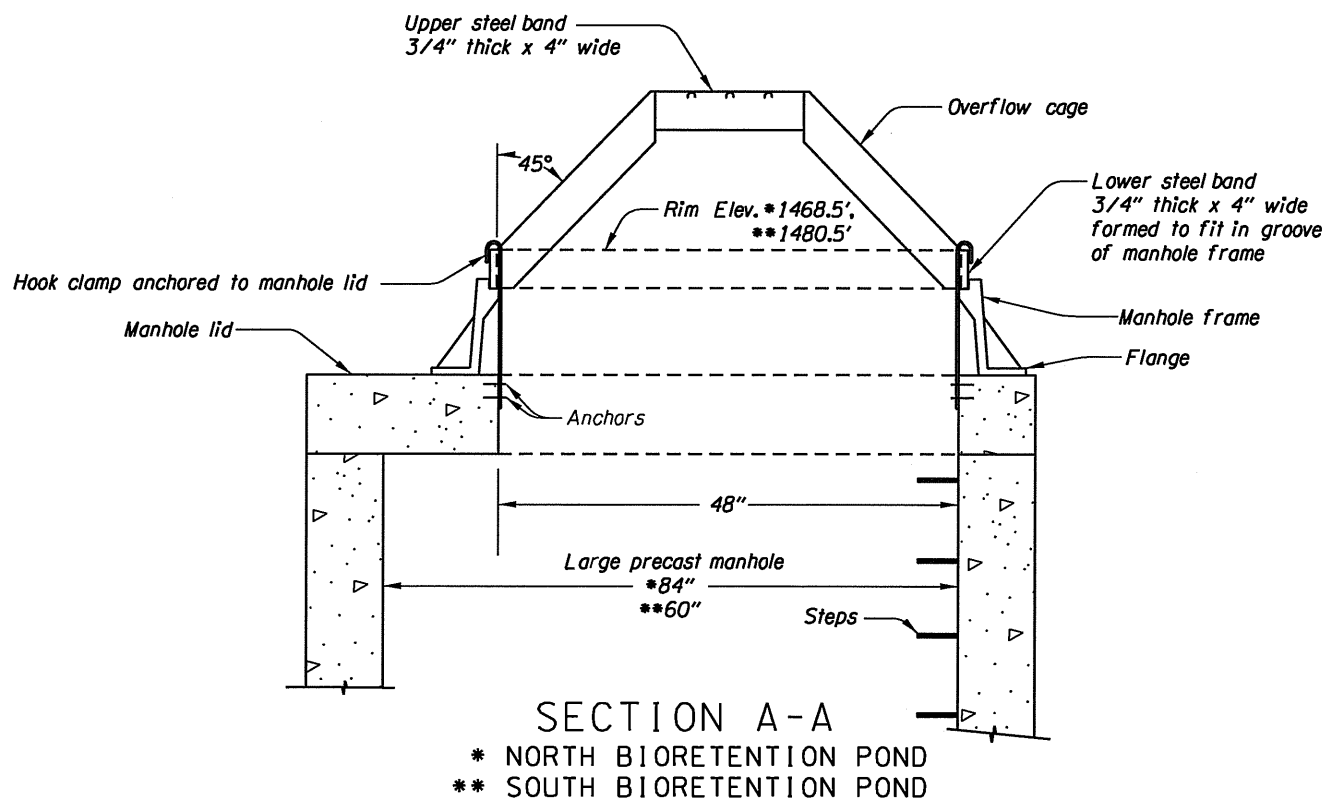
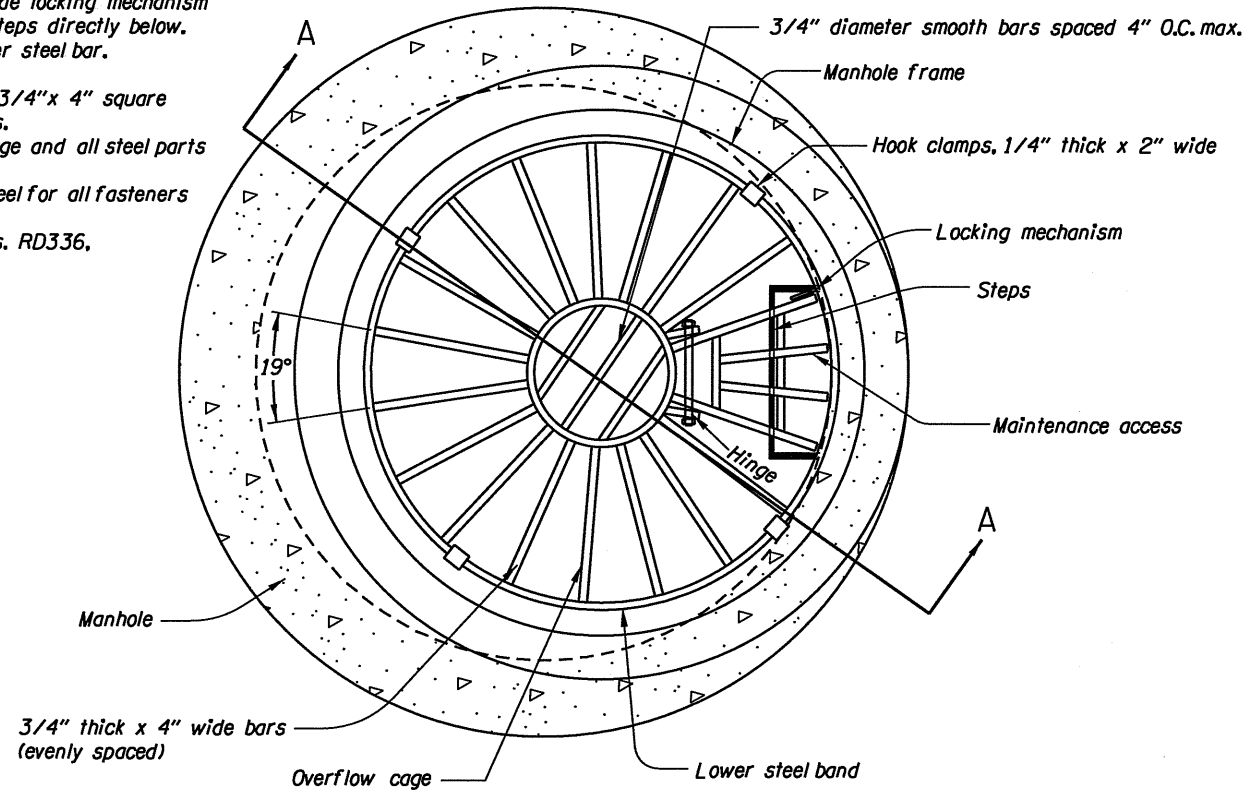

SECTION A-A

* NORTH BIORETENTION POND
** SOUTH BIORETENTION POND

DETAIL "B" - FIELD INLET
(not to scale)

46V-113

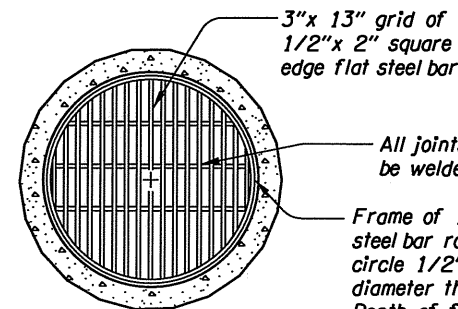
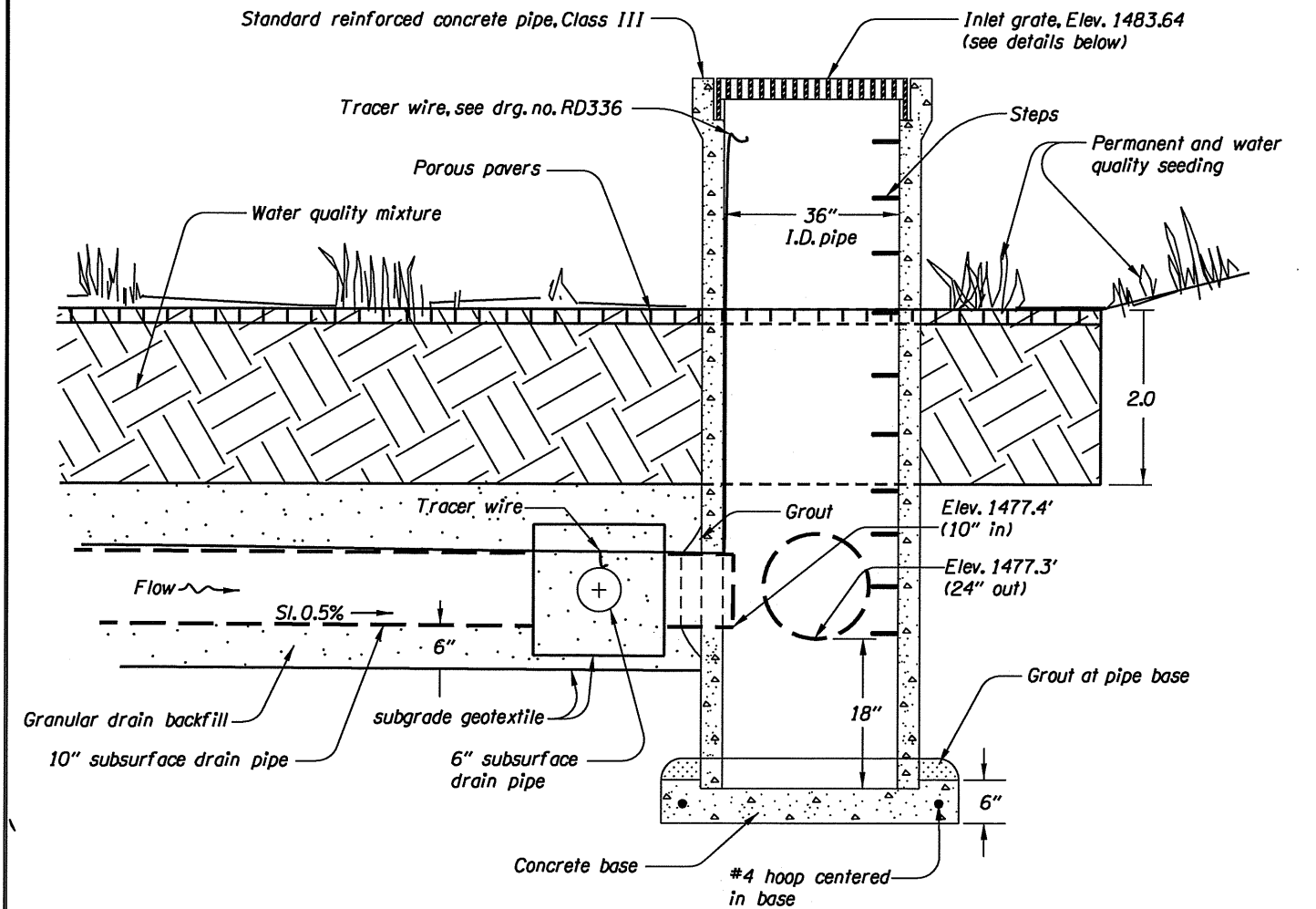

INLET GRATE

- 3"x 13" grid of 1/2"x 2" square edge flat steel bar
- All joints in grate to be welded 1/4"
- Frame of 1/2" square edge steel bar rolled to form circle 1/2" less in outer diameter than pipe bell. Depth of frame to be same as pipe bell depth. Hot-dip galvanize after fabrication.

Notes:

1. Elevations shown are based on NAVD 1988 datum.
2. All dimensions shown are in feet unless otherwise noted.
3. All reinforcement shall be 2" clear of nearest face of conc.
4. All connecting pipes shall have a flexible, gasketed, and unrestrained joint within 18" of vertical 36" I.D. pipe. Joint type varies with manufacturer.
5. To be accompanied by drg. nos. RD312, RD336 & RD374.

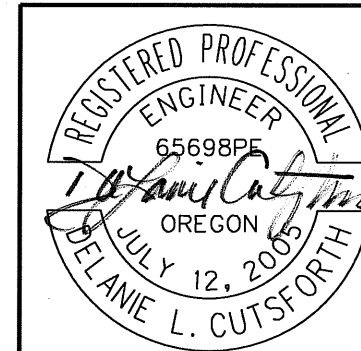

EXPIRES: 12-31-2013

OREGON DEPARTMENT OF TRANSPORTATION	
REGION 3 - TECHNICAL CENTER	
FFO-1-5: FERN VALLEY INTERCHANGE, UNIT 2 PACIFIC HIGHWAY JACKSON COUNTY	
Designed By - DeLanie Cutsforth Reviewed By - Wade Holaday Drafted By - DeLanie Cutsforth	

STORMWATER DETAILS

SHEET NO.
GJ-8

WATER QUALITY SWALE DETAILS (BIOFILTRATION SWALE)

46V-113

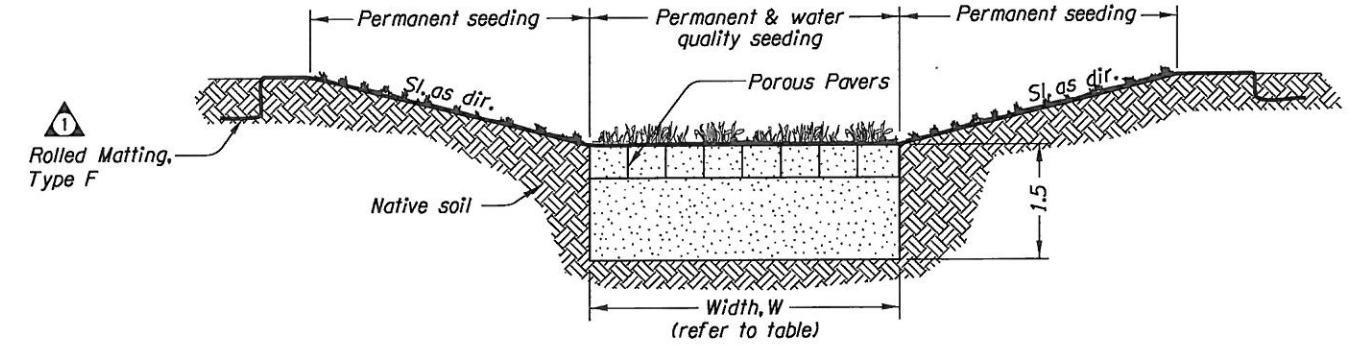
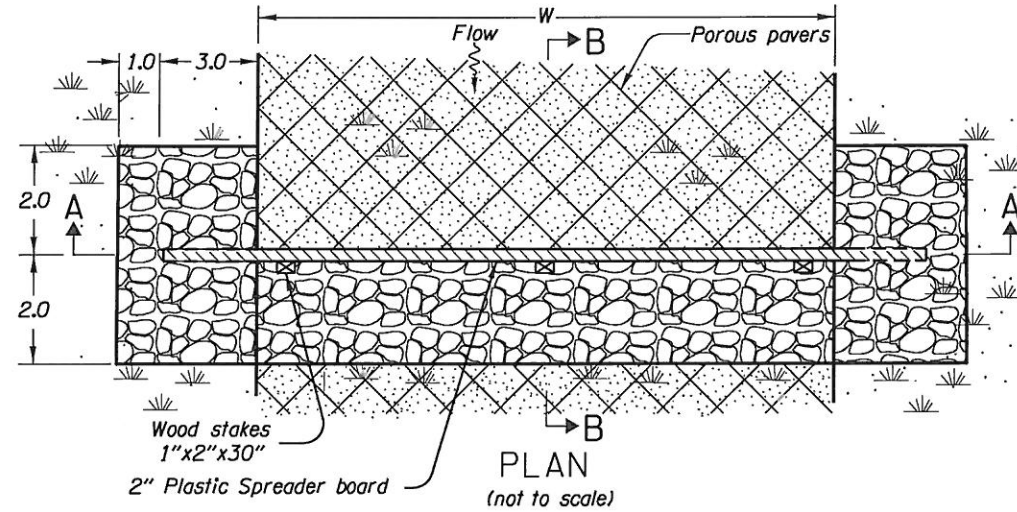

TYPICAL SECTION
(not to scale)

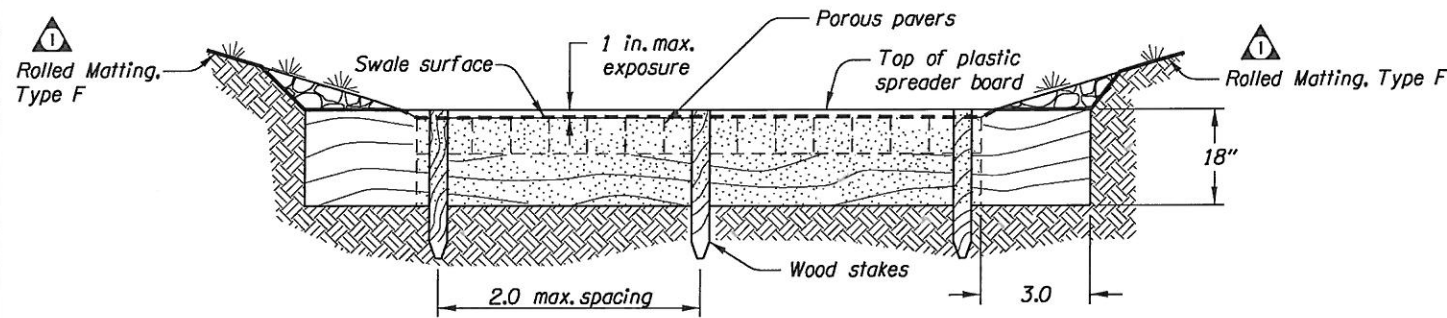

SECTION A-A
(not to scale)

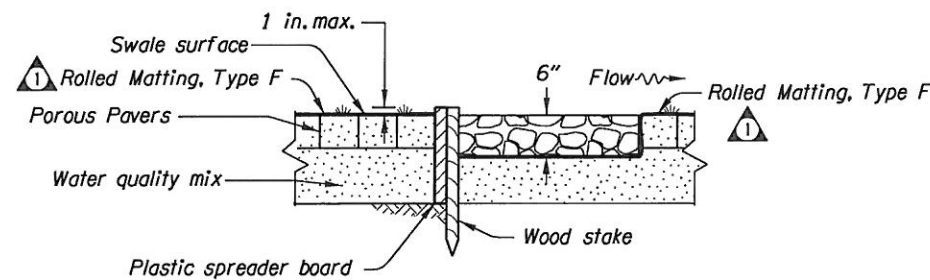

SECTION B-B
(not to scale)

PLASTIC BOARD FLOW SPREADER DETAIL

- NOTES:**
1. Construct spreader board level.
 2. Extend spreader board a minimum of 3 feet into side slopes.
 3. Reinforce side slopes at flow spreader locally with 1 1/2"-3/4" granular drain backfill material.
 4. Fasten wood stakes to spreader board with 2 1/2" galvanized wood screws every 3" (minimum).
 5. Place plastic board flow spreader at beginning and end of swale and every 50 feet throughout length of biofiltration swale.
 6. Install matting according to RD1055. Omit check slots.
 7. Install Type S2 markers at beginning and end of biofiltration swale. See sheet GJ-10 for details.

WATER QUALITY SWALE DATA				
WQ Swale #	Plan sheet & note #	Sta. to Sta.	W (ft.)	Longitudinal Slope (ft./ft.)
1	13B (5)	"NP" 72+82.0 to "NP" 73+82.0, Lt.	4.0	.006
2	13B (5)	"NP" 72+80.0 to "NP" 73+80.0, Rt.	4.0	.002
3	12B (13)	"NP" 58+65.0 to "NP" 59+65.0, Rt.	4.0	.009
4	12B (10)	"NP" 55+00.0 to "NP" 56+50.0, Rt.	4.0	.04
5	3B (3)	"L" 1010+08.0 to "L" 1011+60.0, Rt.	13.0	.005
6	3B (2)	"L" 1008+35.0 to "L" 1009+35.0, Lt.	10.0	.005
7	6B (7)	"NBOFF" 1038+85.0 to "NBOFF" 1039+85.0, Rt.	4.0	.005
8	6B (7)	"SBON" 1036+00.0 to "SBON" 1037+05.0, Rt.	6.5	.005
9	6B (7)	"SBON" 1034+45.0 to "SBON" 1035+45.0, Rt.	4.0	.01
10	6B (7)	"L" 1038+30.0 to "L" 1039+30.0, Lt.	4.0	.01
11	10B-2 (54)	"GR" 412+68.0 to "GR" 413+99.0, Rt.	2.0	0.06

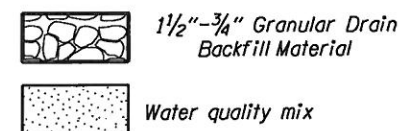

Note: All dimensions are in feet unless otherwise noted.

No.	DATE	REVISIONS	BY
1	03-05-14	Stipulated Matting Type	DC
2	03-05-14	Modified sheet reference	DC

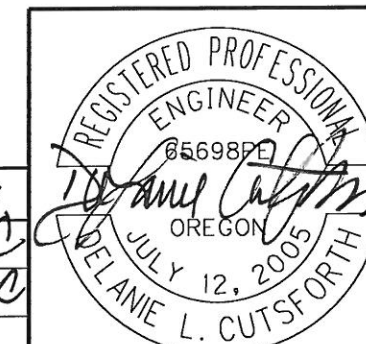

EXPIRES: 12-31-2013

OREGON DEPARTMENT OF TRANSPORTATION

REGION 3 - TECHNICAL CENTER

FFO-1-5: FERN VALLEY INTERCHANGE, UNIT 2
PACIFIC HIGHWAY
JACKSON COUNTY

Designed By - DeLanie Cutsforth
Reviewed By - Wade Holaday
Drafted By - DeLanie Cutsforth

STORMWATER DETAILS

SHEET NO. **GJ-9**

FIELD FACILITY MARKERS

46V-113

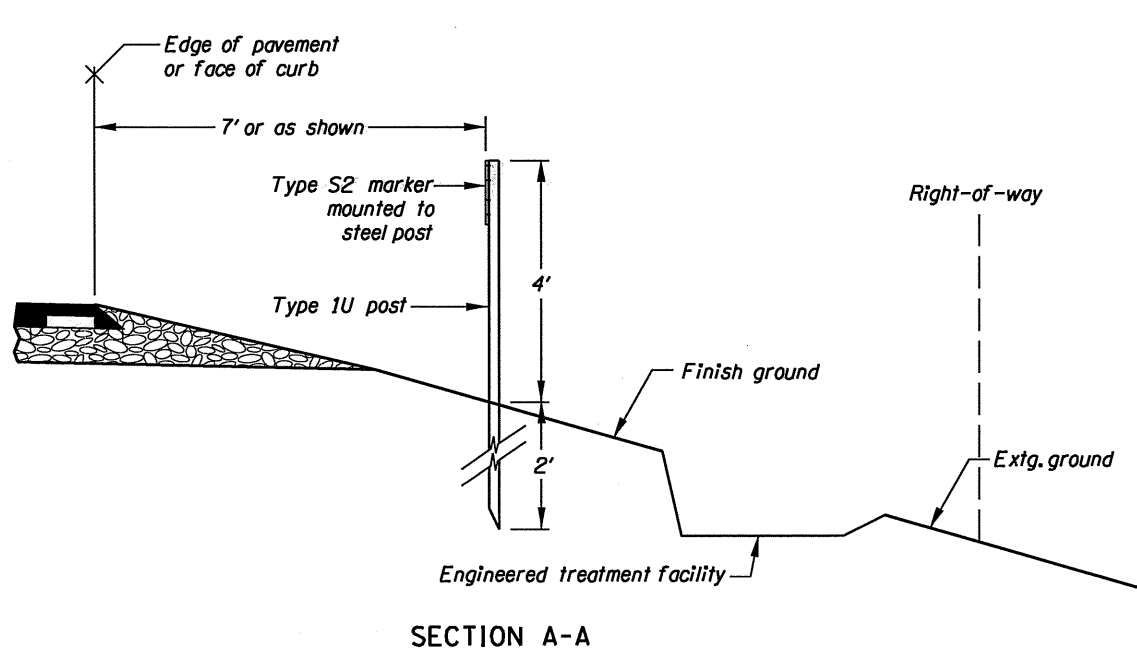

SECTION A-A

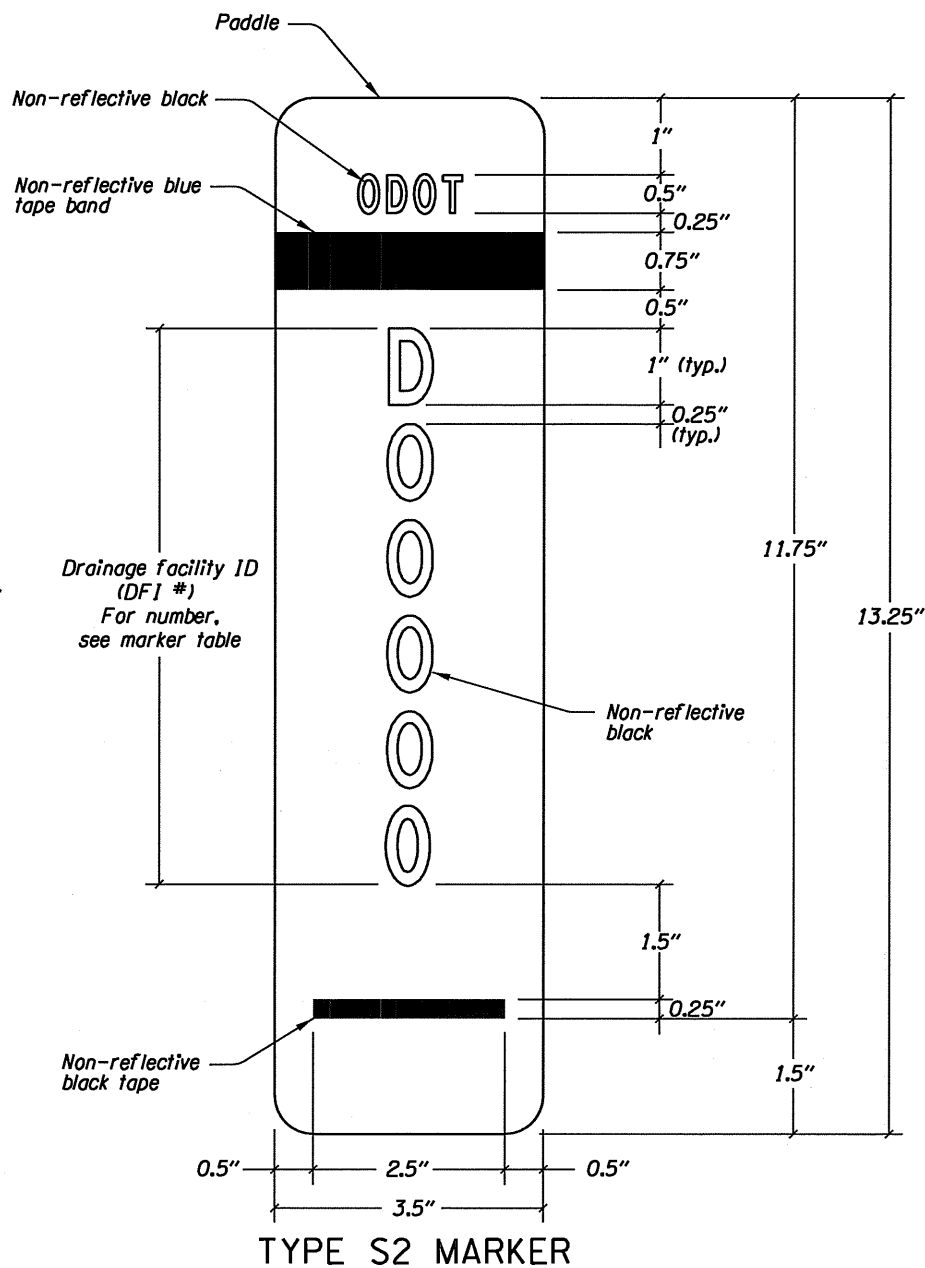

TYPE S2 MARKER

Notes:

- Paddle:**
 - Aluminum sheet, nominal thickness 0.050"
 - White non-reflective background
 - Mount paddle to one (1) type 1U steel post using 3/16" diameter aluminum blind rivets and washers. See standard drawing TM570 detail labeled "Steel Posts" for mounting a traffic target. Install paddle onto Type 1U steel post using same hole pattern.
 - Text and numbers are type C font in non-reflectorized black
 - Band is non-reflective blue tape
 - Do not mount paddle to other highway signing posts
 - Install paddle parallel to travel lane
 - Prepare paddle for each "DFI" noted in the marker table
- Steel Posts:**
 - See drg. no. TM571 for type 1U steel post dimensions
- Place 7 feet from edge of pavement or as directed.**
- See marker table for installation locations.**

MARKER TABLE

FACILITY NAME	FACILITY LOCATION	DFI #	TYPE S2 MARKER	
			BEGIN	END
WQ SWALE #7	"NBOFF" 1038+85.0, Rt.	D00765		✓
WQ SWALE #7	"NBOFF" 1039+85.0, Rt.	D00765	✓	
WQ SWALE #9	"SBON" 1034+45.0, Rt.	D00767	✓	
WQ SWALE #9	"SBON" 1035+45.0, Rt.	D00767		✓
WQ SWALE #8	"SBON" 1036+00.0, Rt.	D00768	✓	
WQ SWALE #8	"SBON" 1037+05.0, Rt.	D00768		✓
WQ SWALE #5	"L" 1010+08.0, Rt.	D00763	✓	
WQ SWALE #5	"L" 1011+60.0, Rt.	D00763		✓
WQ SWALE #6	"L" 1008+35.0, Lt.	D00762		✓
WQ SWALE #6	"L" 1009+35.0, Lt.	D00762	✓	
NORTH POND	"L" 1026+44.0, Lt.	D00760		✓
NORTH POND	"L" 1029+17.0, Lt.	D00760	✓	
SOUTH POND	"L" 1031+65.0, Lt.	D00761		✓
SOUTH POND	"L" 1034+60.0, Lt.	D00761	✓	
SWALE #10	"L" 1038+30.0, Lt.	D00764		✓
SWALE #10	"L" 1039+30.0, Lt.	D00764	✓	
BOLZ POND	"B" 53+67.0, Rt.	D00770	✓	
BOLZ POND	"B" 55+22.0, Rt.	D00770		✓
LUMAN POND	"LU" 167+24.0, Rt.	D00766	✓	
LUMAN POND	"LU" 168+94.0, Rt.	D00766		✓
WQ SWALE #11	"GR" 412+68.0, Rt.	D00769	✓	
WQ SWALE #11	"GR" 413+99.0, Rt.	D00769		✓

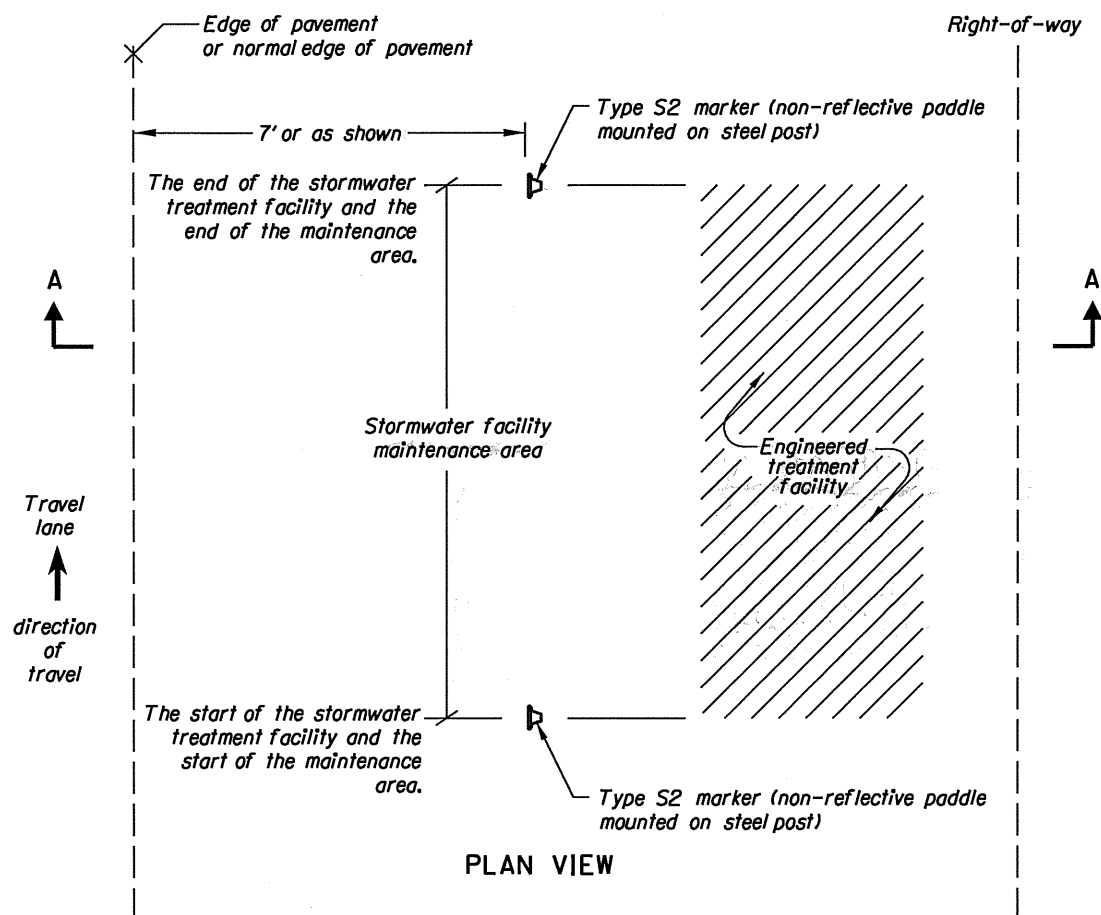

INSTALLATION DETAIL

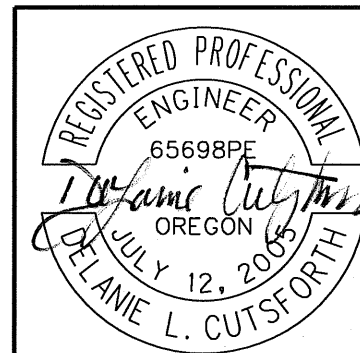

EXPIRES: 12-31-2013

OREGON DEPARTMENT OF TRANSPORTATION

REGION 3 - TECHNICAL CENTER

FFO-1-5: FERN VALLEY INTERCHANGE, UNIT 2
PACIFIC HIGHWAY
JACKSON COUNTY

Designed By - DeLanie Cutsforth
Reviewed By - Wade Holaday
Drafted By - DeLanie Cutsforth

STORMWATER DETAILS SHEET NO. GJ-10