

OPERATION & MAINTENANCE MANUAL

Filterra

Manual prepared: September 2017

DFI No. D00689

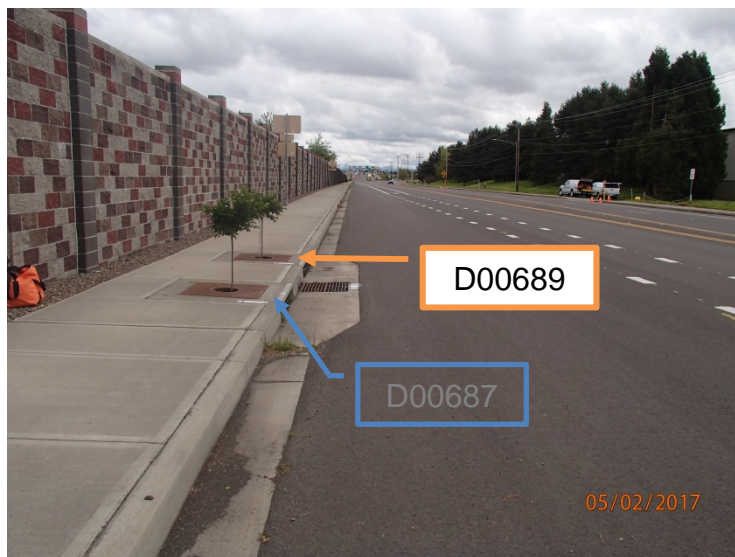

Figure 1: DFI No. D00689, looking East

1. Identification

Drainage Facility ID (DFI): D00689
Facility Type: **Filterra**
Construction Drawings: (V-File Numbers) 46V-051
Location: District: 03
Highway No.: 140
Mile Post: 36.294, LT

2. Manual Purpose

The purpose of this manual is to outline inspection needs and summarize maintenance actions for planted water quality catch basins.

3. Facility Location

The location map below details the facility location. The highway, mile posts, side streets, access location, and stormwater flow directions are noted on the map.

Facility location type: Curb and Gutter (bike lane)

Flow direction:



Figure 2: Facility Location Map

4. Facility Summary

The length and width of the WQ Catch Basin is based on the dimensions of the inside of the treatment cell.

The length and width of the WQ Catch Basin is:

Length (Feet)	Width (Feet)	Designation Number ¹
6	4	FT0604

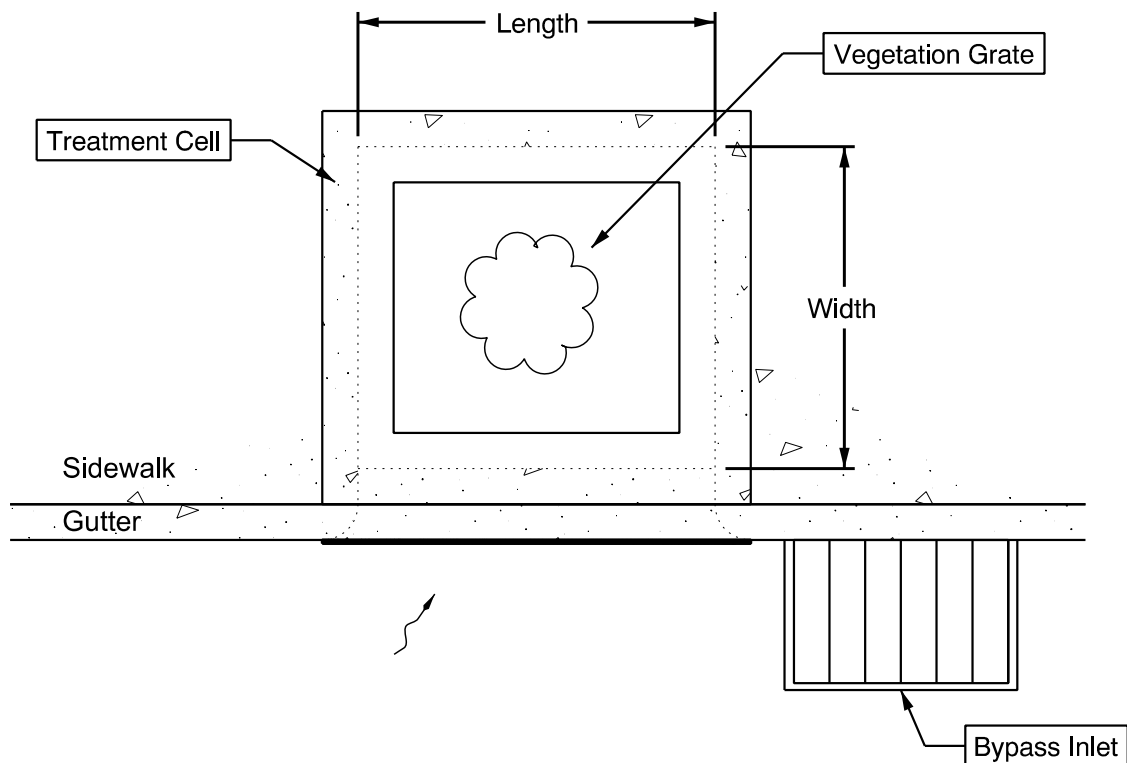

Site Specific Information: Located on the West side of the I-5 Woodburn Interchange. See Appendix B for additional information.

¹ The Filterra and MWS designation number is associated with the dimensions of this type of proprietary structure. See appendix C of the Standard Operation Manual for Water Quality Catch Basins to view the Configuration Details for additional information.

5. Facility Access

Maintenance access to the facility: Curb and gutter (travel lane)

Lane Closure Needed

Water quality catch basins do not typically have access roads/access pads, nor are they gated, as they are located in urban areas alongside sidewalks and curbs. Use caution when accessing these facilities as there may be pedestrians or cyclists in the vicinity.

6. Operational Components / Maintenance Items

Classification and Standard Operational (Op) Plan:

This facility is classified as a:

<input checked="" type="checkbox"/> Filterra (Op Plan A)	<input type="checkbox"/> WQ Planter (Op Plan B)	<input type="checkbox"/> MWS (Op Plan C)
A Filterra is a single chamber treatment cell that utilizes filter media, a plant, and a perforated underdrain.	A WQ Planter is a single chamber treatment cell that utilizes plants, filter media, and a perforated underdrain. The auxiliary outlet is located inside of the treatment cell.	A <u>Modular Wetland System</u> is a three chamber treatment cell that utilizes plants, filter media, filter media cartridges, and a perforated underdrain network.
A standard operational plan illustrates the general facility footprint configuration and explains the purpose of each facility component. Operational plans (A and B) are provided in the Standard Operation Manual.		

See Appendix A for the site specific operational plan.

Operational Components

The facility components table (**Table 1**) has been provided to highlight the applicable components for this facility. The component is in use when the box contains an “x” (e.g.).

The Standard Operation Manual for Water Quality Catch Basins (implemented April 2018) outlines facility operation, typical footprint configuration, and component definitions and details. A link to the manual is attached to the feature marker in TransGIS. <https://gis.odot.state.or.us/TransGIS/>

Maintenance Items

Operational components marked in **Table 1** should be inspected and maintained according to Section 7. Each facility component is defined and detailed in the Standard Operation Manual using the associated ID number indicated below.

Table 1: Facility Components		ID #
Facility Inlet		
Inlet Grate	<input type="checkbox"/>	C1
Curb Inlet	<input checked="" type="checkbox"/>	C2
Sidewalk Chute	<input type="checkbox"/>	C3
Bypass Inlet	<input checked="" type="checkbox"/>	C4
Treatment		
Plantings (Tree or Shrub)	<input checked="" type="checkbox"/>	C5
Filter Media	<input checked="" type="checkbox"/>	C6
Filter Media Cartridge	<input type="checkbox"/>	C7
Outfall Type		
Waterbody (Creek/Lake/Ocean)	<input type="checkbox"/> C	C8
	<input type="checkbox"/> L	
	<input type="checkbox"/> O	
Ditch	<input type="checkbox"/>	C9
Storm Drain System	<input checked="" type="checkbox"/>	C10

7. Maintenance

Maintenance Frequency/Maintain Records

- Inspect per manufacturer requirements. Preferably prior to the rainy season.
- Clean and maintain as necessary. Refer to Activity 125 in the Maintenance Guide for conditions when maintenance is needed.
- Keep a record of inspections, maintenance, and repairs.

Maintenance Guide/Maintenance Actions

Proprietary Water Quality Catch Basins have an operation and maintenance manual provided by the manufacturer. See Appendix C of the Standard Operational Manual for Water Quality Catch Basins. These manuals provided guidelines on maintenance procedures for the facilities. A link to the manual is attached to the feature marker in TransGIS. <https://gis.odot.state.or.us/TransGIS/>

The Maintenance Guide outlines the standard maintenance actions for water quality facilities under Activity 125.

There are standard maintenance tables for standard ODOT designs. The maintenance tables describe the maintenance component, the defect or problem, the condition when maintenance is needed, and the recommended maintenance to correct the problem. Use the following tables to maintain ODOT Water Quality Catch Basins:

- Table 1 (General Maintenance): Contains general maintenance and inspection guidelines that are applicable to all ODOT water quality facilities

The ODOT Maintenance Guide can be viewed at the following website:

<http://www.oregon.gov/ODOT/HWY/OOM/pages/mguide.aspx>

8. Waste Material Handling

Material removed from the facility is defined as waste by the Department of Environmental Quality (DEQ). Refer to the road waste section of the ODOT Maintenance Yard Environmental Management System (EMS) Policy and Procedures Manual for disposal options:

<http://www.oregon.gov/ODOT/HWY/OOM/pages/ems.aspx>

Contact any of the following for more detailed information about management of waste materials found on site:

ODOT Clean Water Unit	(503) 986-3008
ODOT Statewide Hazmat Coordinator	(503) 667-7442
ODOT Region 1 Hazmat Coordinator	(503) 731-8290
ODOT Region 2 Hazmat Coordinator	(503) 986-2647
ODOT Region 3 Hazmat Coordinator	(541) 957-3594
ODOT Region 4 Hazmat Coordinator	(541) 388-6186
ODOT Region 5 Hazmat Coordinator	(541) 963-1590
ODEQ Northwest Region Office	(503) 229-5263

A Appendix A – Site Specific Operational Plan

Contents:

Operational Plan: DFI D00689

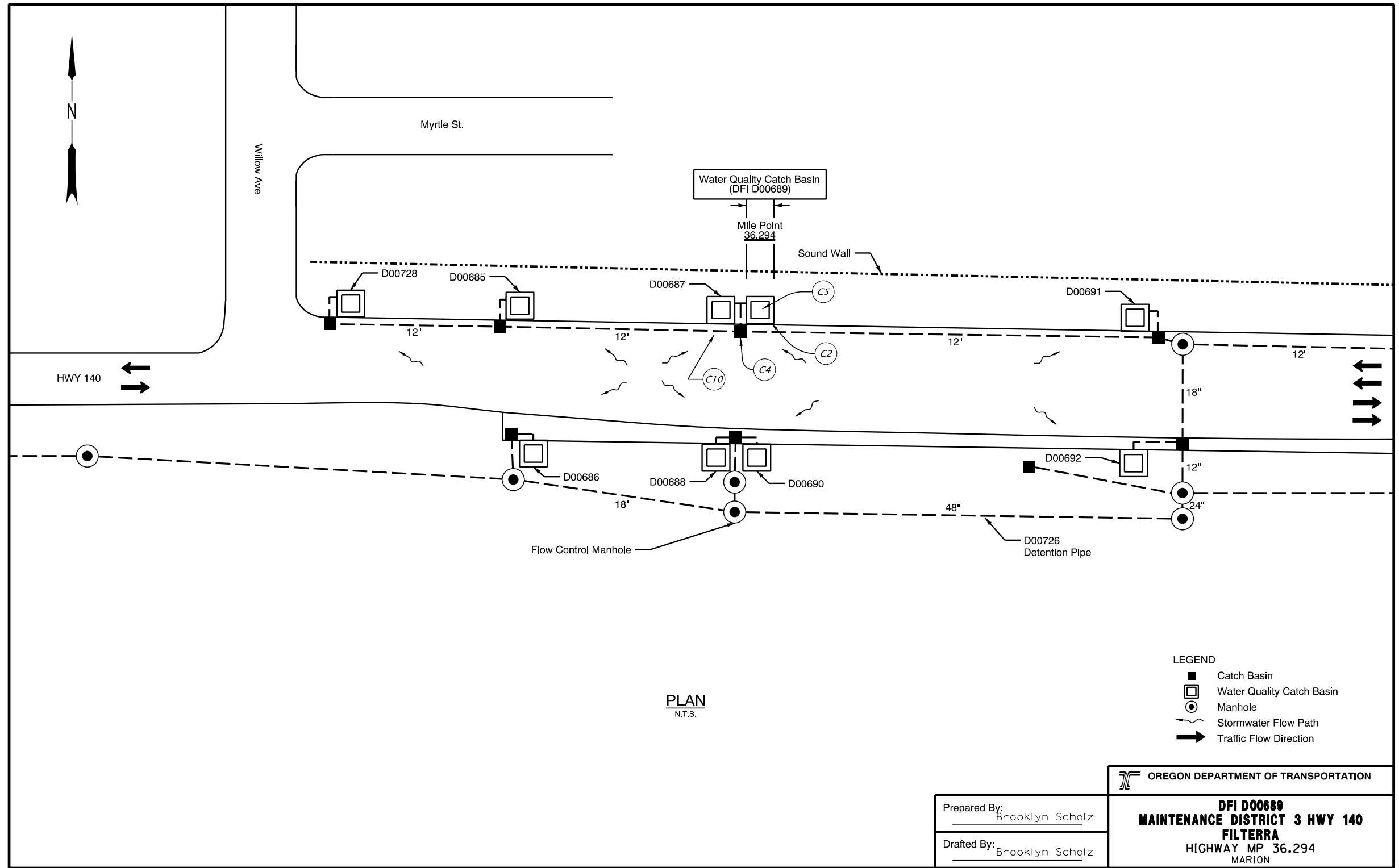

DF1_D00000.dgn

B Appendix B – Project Contract Plans

Contents:

Site Specific Subset of Project Contract Plan 46V-051

INDEX OF SHEETS	
SHEET NO.	DESCRIPTION
1	Title Sheet
1A	Index Of Sheets Contd.
1A-2	Index Of Sheets Contd.
1A-3	Standard Drg. Nos.

STATE OF OREGON
DEPARTMENT OF TRANSPORTATION
PLANS FOR PROPOSED PROJECT

GRADING, DRAINAGE, STRUCTURES, PAVING, SIGNING,
ILLUMINATION, SIGNAL & ROADSIDE DEVELOPMENT

**FFO - I-5 @ OR214 INTERCHANGE
(WOODBURN) DEVELOPMENT SEC.**

HILLSBORO - SILVERTON HIGHWAY

MARION COUNTY

△ JUNE 2013

**BEGINNING OF
CONTRACT PROJECT**

STP-S140(045)

STA. "L"952+05 (M.P. 276.01)

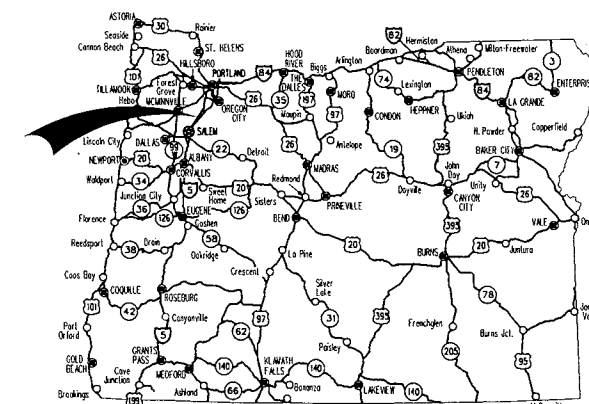

Overall Length Of Project - 2.76 Miles

ATTENTION:
Oregon Law Requires You To Follow Rules Adopted By The Oregon Utility Notification Center. Those Rules Are Set Forth In OAR 952-001-0010 Through OAR 952-001-0090. You May Obtain Copies Of The Rules By Calling The Center. (Note: The Telephone Number For The Oregon Utility Center Is (503) 232-1987.)

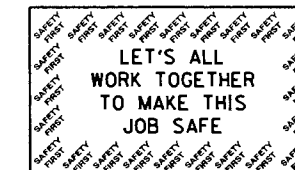

No.	DATE	REVISIONS	BY
①	4-18-13	Edited station & MP for the end of contract	J.O.L.
②	5-16-13	Changed date	C.A.C.

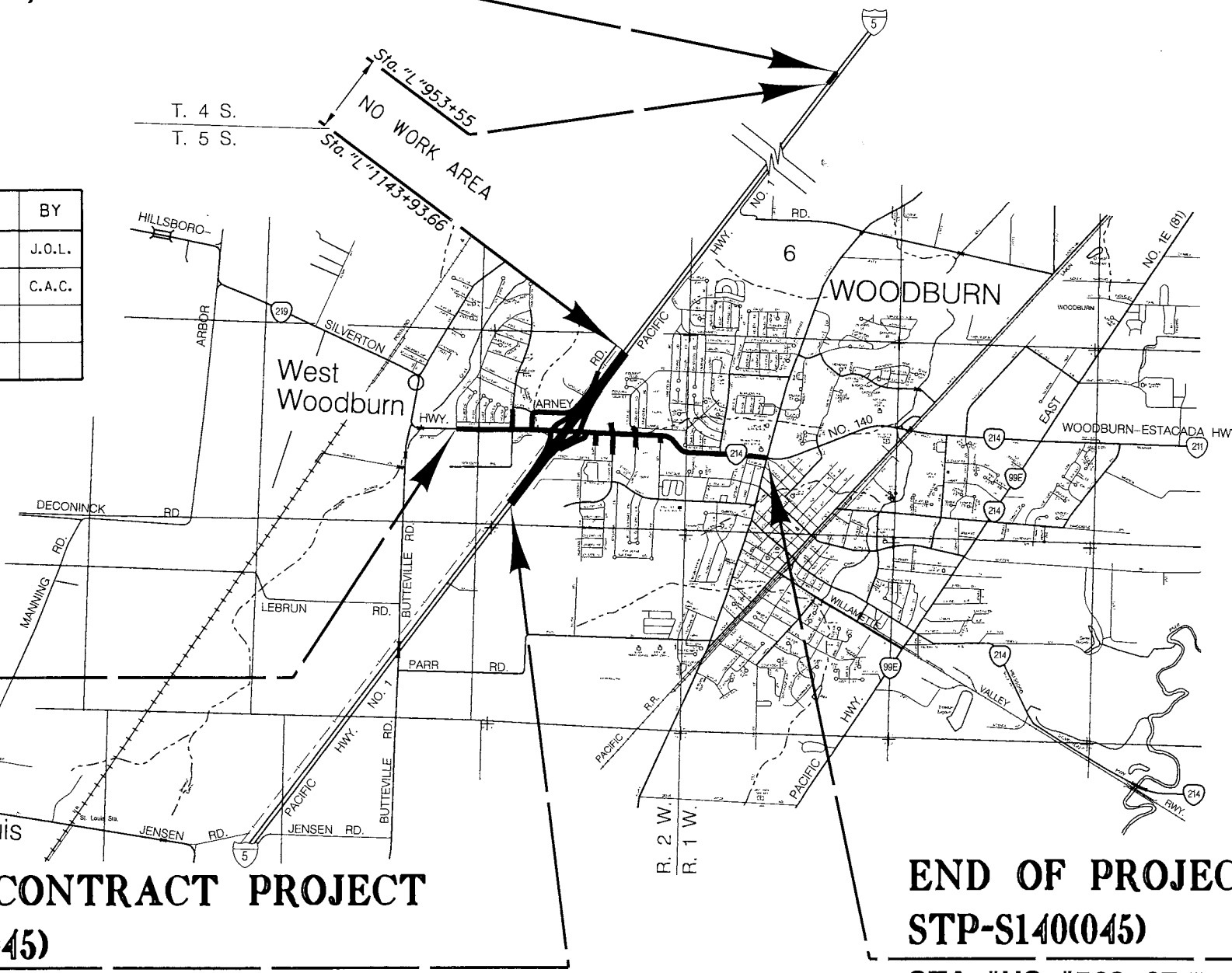

**BEGINNING OF
PROJECT**

STP-S140(045)

**STA. "HSc"477+21
(M.P. 36.24)**

END OF CONTRACT PROJECT

STP-S140(045)

△ STA. "L"1199+66.06 (M.P. 271.35)

END OF PROJECT

STP-S140(045)

STA. "HSc"562+67.5 (M.P. 37.87)

T. 5 S., R. 1 & 2 W., W.M.



OREGON TRANSPORTATION COMMISSION

- Pat Egan CHAIR
- David Lohman COMMISSIONER
- Mary F. Olson COMMISSIONER
- Mork Frohnmayer COMMISSIONER
- Tommy Boney COMMISSIONER
- Matthew L. Garrett DIRECTOR OF TRANSPORTATION

These plans were developed using ODOT design standards. Exceptions to these standards, if any, have been submitted and approved by the ODOT Chief Engineer or their delegated authority.

By: *[Signature]* 5-20-13
Signature & date

Michael T. Long - R2 Tech Center Manager
Print name and title

Concurrence by ODOT Chief Engineer

FFO - I-5 @ OR214 INTERCHANGE
(WOODBURN) DEVELOPMENT SEC.
HILLSBORO - SILVERTON HIGHWAY
MARION COUNTY

FEDERAL HIGHWAY ADMINISTRATION	PROJECT NUMBER	SHEET NO.
OREGON DIVISION	STP-S140(045)	1

PE00 0559 040

Sec. 11, T. 5 S., R. 2 W., W.M.



THOMAS ROY
DLC NO. 82

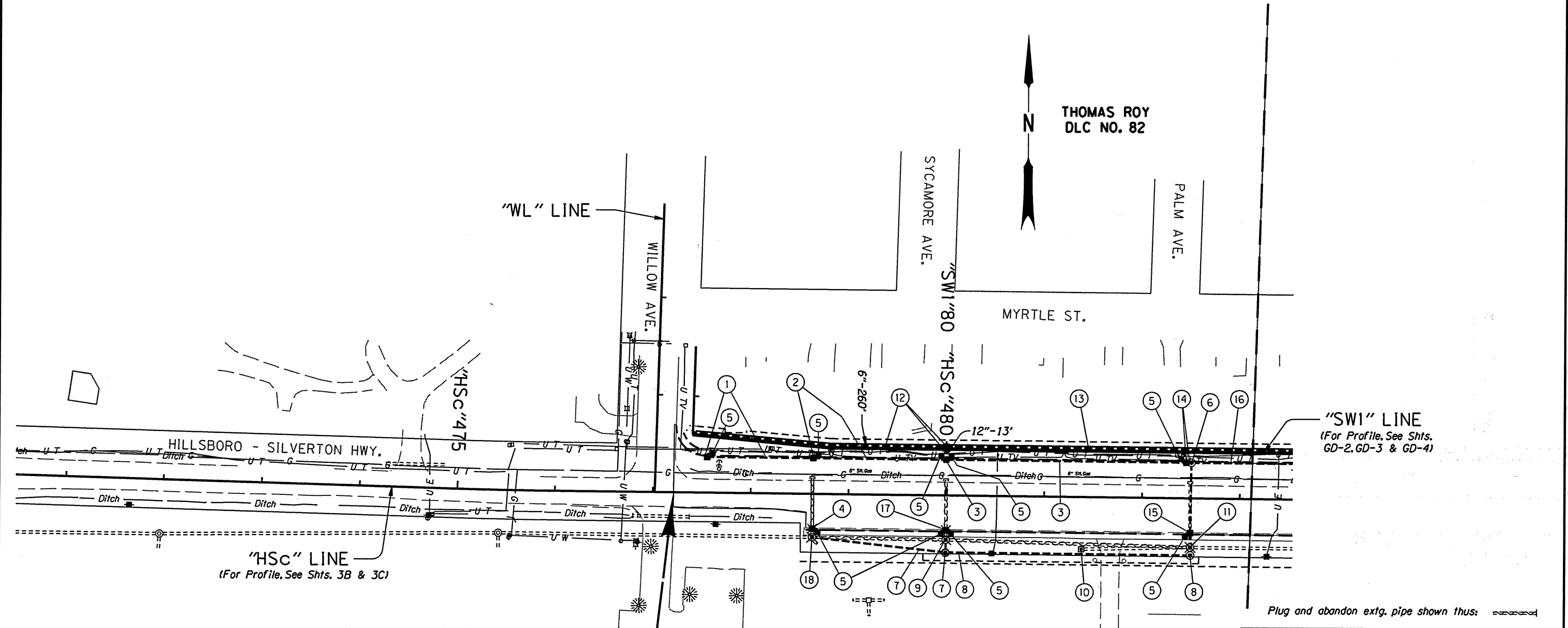

"HSC" LINE
(For Profile. See Shts. 3B & 3C)

"SWI" LINE
(For Profile. See Shts. GD-2, GD-3 & GD-4)

Plug and abandon extg. pipe shown thus:

BEGINNING OF PROJECT
STP-S140(045)
STA. "HSC"477+21 (M.P. 36.24)

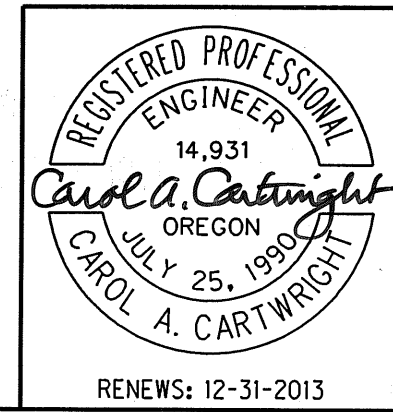

OREGON DEPARTMENT OF TRANSPORTATION	
REGION 2 TECH CENTER	
FFO-1-5 @ OR214 INTERCHANGE (WOODBURN) DEVELOPMENT SEC. HILLSBORO - SILVERTON HIGHWAY MARION COUNTY	
Design Team Leader - Carol Cartwright Designed By - John Lucas Drafted By - Charlotte Gerken	
DRAINAGE & UTILITIES	SHEET NO. 3A

① Sta. "HSc"477+55 to Sta. "HSc"478+63.8 Lt.
Const. type "CG-2" Mod. inlet
Adjust inlet
Inst. 12" storm sew. pipe - 109'
5' depth
(For details, see sht. 2B-15)
(See drg. nos. RD300, RD326, RD366,
RD376, RD380, RD384, RD386, RD388,
RD390, RD391 & RD393)

② Sta. "HSc"478+63.8 to Sta. "HSc"480+00, Lt.
Const. type "CG-2" Mod. inlet
Adjust inlet
Inst. 12" storm sew. pipe - 136'
5' depth
(For details, see sht. 2B-15)

③ Sta. "HSc"480+00 to Sta. "HSc"482+50.3, Lt.
Const. type "CG-2" Mod. inlet
Adjust inlet
Inst. 12" storm sew. pipe - 250'
5' depth
(For details, see sht. 2B-15)

① ④ Sta. "HSc"478+68.8
Remove extg. inlet
Const. type "CG-2" Mod. inlet
Adjust inlet
(For details, see sht. 2B-15)

⑤ Const. water quality structure - 9
Connect to inlet
(For details, see shts. GJ-10 & GJ-11)

⑥ Sta. "HSc"482+50, Lt.
Remove extg. pipe - 74'
Const. manhole
Step orientation - 312°
Minor adjust manhole
Inst. 18" storm sew. pipe - 87'
10' depth
Connect to extg. manhole
(See drg. nos. RD335, RD336, RD344,
RD356 & RD360)

⑦ ⑦ Sta. "HSc"478+63.5 to Sta. "HSc"480+00.3, Rt.
Const. flow control manhole 84" dia.
Connect to extg. manhole
Inst. 18" storm sew. pipe - 138'
20' depth
(For details, see shts. GJ-7 & GJ-8)
(See drg. nos. RD340 & RD346)

① ⑧ Sta. "HSc"480+00.3 to Sta. "HSc"482+50, Rt.
Const. manhole, 84" dia.
Step orientation - 180°
Inst. 48" storm sew. pipe - 250'
20' depth
(For details, see sht. GJ-7)

⑨ Sta. "HSc"480+00, Rt.
Major adjust manhole
Inst. 12" storm sew. pipe - 13'
5' depth
(For details, see sht. GJ-7)

⑩ Sta. "HSc"481+38.5, Rt.
Adjust inlet
(See drg. no. RD376)

⑪ Sta. "HSc"482+50, Rt.
Major adjust manhole
Inst. 24" storm sew. pipe - 8'
5' depth

⑫ Sta. "HSc"477+40 to Sta. "HSc"479+99.8, Lt.
Const. 24" area drainage basin, without apron
Inst. 6" subsurface drain pipe - 260'
5' depth
Inst. 12" storm sew. pipe - 13'
5' depth
Drainage geotextile type "1" - 240 sq. yd.
(See drg. nos. RD312 & RD374)

⑬ Sta. "HSc"480+03 to Sta. "HSc"484+00, Lt.
Inst. 6" subsurface drain pipe - 400'
5' depth
Drainage geotextile type "1" - 370 sq. yd.

⑭ Sta. "HSc"482+45 to Sta. "HSc"482+50.3, Lt.
Const. type "CG-2" Mod. inlet
Adjust inlet
Inst. 12" storm sew. pipe - 5'
5' depth
(For details, see sht. 2B-15)

① ⑮ Sta. "HSc"482+50, Rt.
Remove extg. inlet
Const. type "CG-2" Mod. inlet
Adjust inlet
Inst. 12" storm sew. pipe - 15'
5' depth
(For details, see sht. 2B-15)

⑯ Sta. "HSc"482+50.3 to Sta. "HSc"484+05.7, Lt.
Inst. 12" storm sew. pipe - 155'
10' depth

① ⑰ Sta. "HSc"480+05.6
Remove extg. inlet
Const. type "CG-2" Mod. inlet
Adjust inlet
(For details, see sht. 2B-15)

⑱ Sta. "HSc"478+63.5, Rt.
Major adjust manhole

No.	DATE	REVISIONS	BY
①	4-18-13	Edited text	J.O.L.
⑦	5-21-13	Edited text	C.A.C.

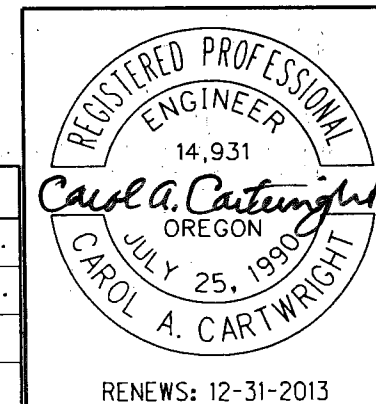

OREGON DEPARTMENT OF TRANSPORTATION	
REGION 2 TECH CENTER	
FFO - I-5 @ OR214 INTERCHANGE (WOODBURN) DEVELOPMENT SEC. HILLSBORO - SILVERTON HIGHWAY MARION COUNTY	
Design Team Leader - Carol Cartwright Designed By - John Lucas Drafted By - Charlotte Gerken	
DRAINAGE NOTES	SHEET NO. 3A-2

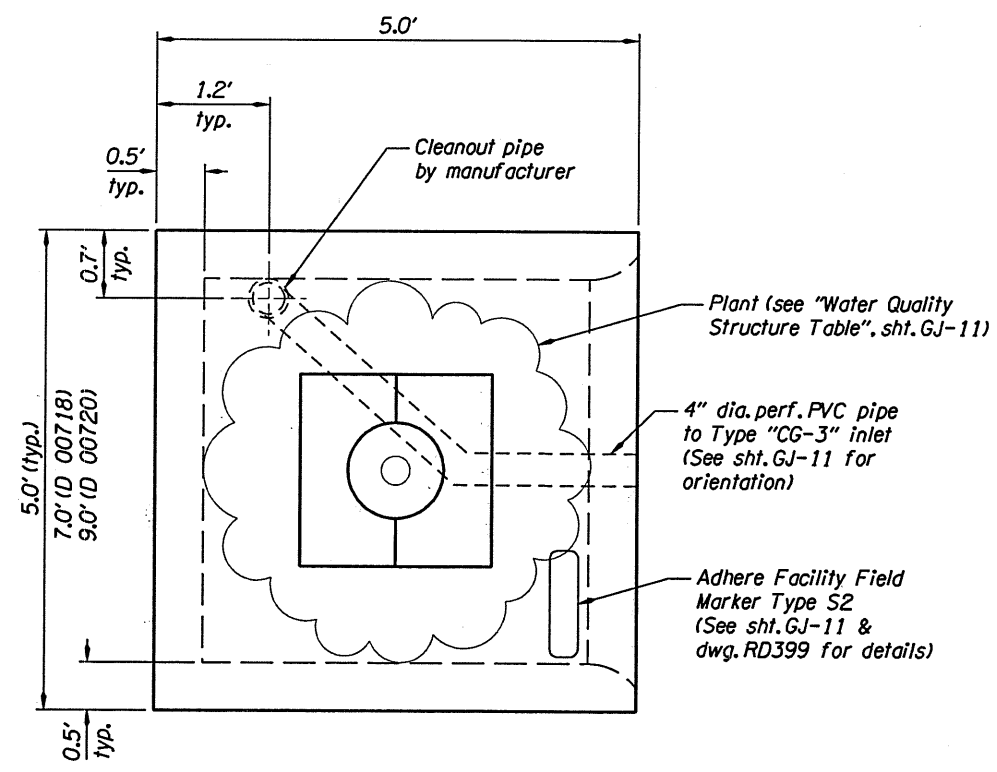

PLAN

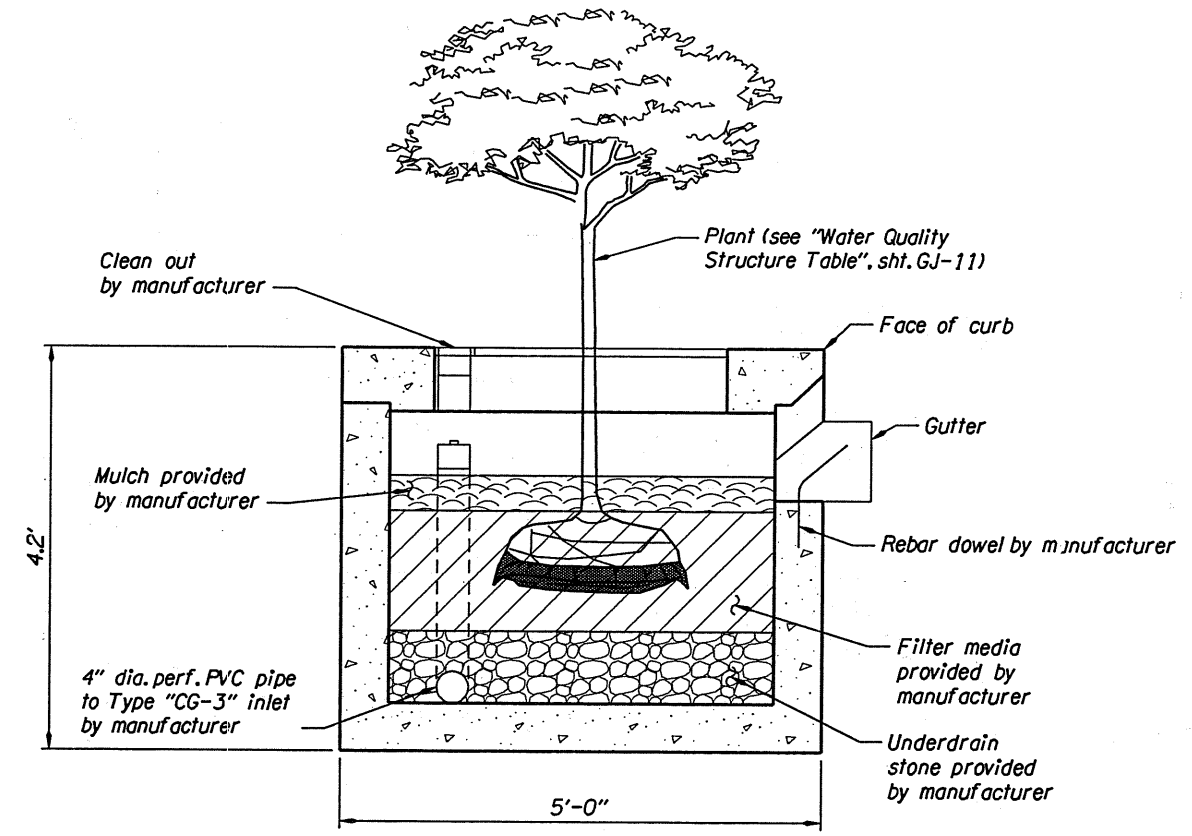

SECTION

WATER QUALITY STRUCTURE DETAILS

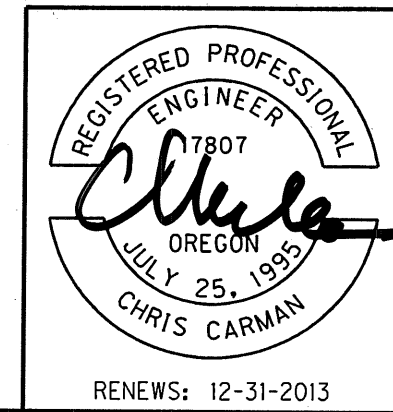

RENEWS: 12-31-2013

OREGON DEPARTMENT OF TRANSPORTATION	
REGION 2 TECH CENTER	
FFO-15 @ OR214 INTERCHANGE (WOODBURN) DEVELOPMENT SEC. HILLSBORO - SILVERTON HIGHWAY MARION COUNTY	
Reviewed By - Bruce Carmichael Designed By - Chris Carman Drafted By - Sandra Gish	
STORMWATER STORAGE POND DETAILS	SHEET NO. GJ-10

WATER QUALITY STRUCTURE TABLE

DRAINAGE FACILITY I.D. MARKER	"HSC" STATION	LT./RT.	OUTLET PIPE ORIENTATION	STORMWATER CONTROL FACILITY TREATMENT CATEGORY
D 00728	477+60.16	Lt.	C	Clara Snow Indian Hawthorne
D 00685	478+68.93	Lt.	C	Clara Snow Indian Hawthorne
D 00686	478+68.84	Rt.	B	Clara Snow Indian Hawthorne
D 00687	479+94.84	Lt.	A	Clara Snow Indian Hawthorne
D 00688	479+95.27	Rt.	B	Clara Snow Indian Hawthorne
D 00689	480+05.15	Lt.	C	Clara Snow Indian Hawthorne
D 00690	480+05.61	Rt.	B	Clara Snow Indian Hawthorne
D 00691	482+39.81	Lt.	A	Clara Snow Indian Hawthorne
D 00692	482+44.59	Rt.	B	Clara Snow Indian Hawthorne
D 00693	483+95.23	Lt.	A	Clara Snow Indian Hawthorne
D 00694	483+94.29	Rt.	B	Clara Snow Indian Hawthorne
D 00695	485+95.41	Lt.	A	Clara Snow Indian Hawthorne
D 00696	485+94.51	Rt.	B	Clara Snow Indian Hawthorne
D 00697	487+43.91	Lt.	A	Clara Snow Indian Hawthorne
D 00698	487+45.01	Rt.	B	Clara Snow Indian Hawthorne
D 00699	488+94.27	Lt.	A	Clara Snow Indian Hawthorne
D 00700	488+94.79	Rt.	B	Rose Creek Abelia
D 00701	489+93.83	Lt.	A	Rose Creek Abelia
D 00702	489+93.83	Rt.	C	Rose Creek Abelia
D 00703	490+34.17	Lt.	C	Rose Creek Abelia
D 00704	490+34.16	Rt.	A	Rose Creek Abelia

WATER QUALITY STRUCTURE TABLE CONT.

DRAINAGE FACILITY I.D. MARKER	"HSC" STATION	LT./RT.	OUTLET PIPE ORIENTATION	STORMWATER CONTROL FACILITY TREATMENT CATEGORY
D 00705	493+01.74	Lt.	C	Rose Creek Abelia
D 00706	493+24.46	Rt.	A	Rose Creek Abelia
D 00707	495+66.83	Lt.	A	Rose Creek Abelia
D 00708	495+34.83	Rt.	B	Rose Creek Abelia
D 00709	496+61.16	Lt.	A	Rose Creek Abelia
D 00710	496+44.84	Rt.	C	Rose Creek Abelia
D 00711	496+83.32	Rt.	A	David Viburnum
D 00712	498+36.46	Lt.	C	David Viburnum
D 00713	498+60.63	Rt.	A	David Viburnum
D 00714	499+57.23	Rt.	B	David Viburnum
D 00715	500+51.62	Lt.	C	David Viburnum
D 00716	538+24.42	Lt.	A	David Viburnum
D 00717	538+99.37	Lt.	A	David Viburnum
D 00718	540+24.36	Lt.	A	David Viburnum
D 00719	540+86.99	Lt.	C	David Viburnum
D 00720	542+74.86	Lt.	A	David Viburnum
D 00721	543+18.11	Rt.	B	David Viburnum
D 00722	543+40.64	Lt.	A	David Viburnum
D 00723	543+64.85	Rt.	C	David Viburnum
D 00724	543+82.96	Lt.	C	David Viburnum
D 00725	543+90.18	Rt.	A	David Viburnum

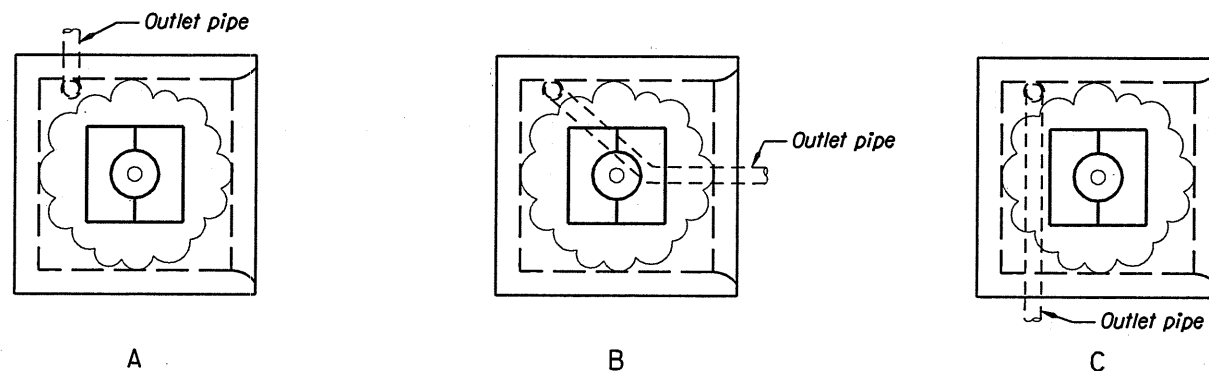

OUTLET PIPE ORIENTATIONS

WATER QUALITY STRUCTURE DETAILS

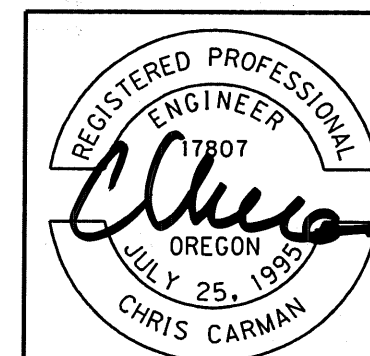

RENEWS: 12-31-2013

OREGON DEPARTMENT OF TRANSPORTATION

REGION 2 TECH CENTER

**FFO-15 @ OR214 INTERCHANGE
(WOODBURN) DEVELOPMENT SEC.
HILLSBORO - SILVERTON HIGHWAY
MARION COUNTY**

Reviewed By - Bruce Carmichael
Designed By - Chris Carman
Drafted By - Sandra Gish

**STORMWATER STORAGE POND
DETAILS**

SHEET NO.
GJ-11