

OPERATION & MAINTENANCE MANUAL

DFI No.: D00382

**Facility Type: Water Quality Biofiltration
Swale**



MARCH, 2011

1. Identification

Drainage Facility ID (DFI): **D00382**
Facility Type: Water Quality Biofiltration Swale
Construction Drawings: (V-File Number) 43V-063
Location: District: 7
Highway No.: 035
Mile Post: 70.27 / 70.29 (beg./end)
Description: This facility is located on the southern side of OR42 (Hwy 035, Coos Bay-Roseburg Highway). Access can be obtained from the eastbound shoulder of the highway.

2. Facility Contact Information

Contact the Engineer of Record, Region Technical Center, or Geo-Environmental's Senior Hydraulics Engineer for:

- Operational clarification
- Maintenance clarification
- Repair or restoration assistance

Engineering Contacts:

Region Technical Center Hydraulics Engineer (541) 957-3693

Or

Geo-Environmental Senior Hydraulics Engineer (503) 986-3365.

3. Construction

Engineer of Record: ODOT Designer – Region 3 Tech. Center, Brian Banta, 541-957-3573

Facility construction: 2006
Contractor: LTM Inc. Construction Company.]

4. Storm Drain System and Facility Overview

A water quality swale is a flat-bottomed open channel designed to treat stormwater runoff from highway pavement areas. This type of facility is lined with grass. Treatment by trapping sedimentation occurs when stormwater runoff flows through the grass.

Stormwater is conveyed to the facility from sheet flow generated by OR42. Refer to the Operational Plan in Appendix A for further information. Water conveyed into the swale undergoes treatment as it flows through the length of the channel. The treated water flows out of the swale and into a seasonal creek. This creek discharges to the south directly off of ODOT right-of-way.

A. Maintenance equipment access:

Maintenance crews can access the facility from the eastbound shoulder of OR42.

B. Heavy equipment access into facility:

- Allowed (no limitations)
- Allowed (with limitations)
- Not allowed

C. Special Features:

- Amended Soils
- Porous Pavers
- Liners
- Underdrains



Photo 1: Looking west, sheet flow from OR42 on the left side of the picture contributes stormwater into the swale.



Photo 2: Looking west, sheet flow from OR42 on the right side of the picture contributes stormwater into the swale.

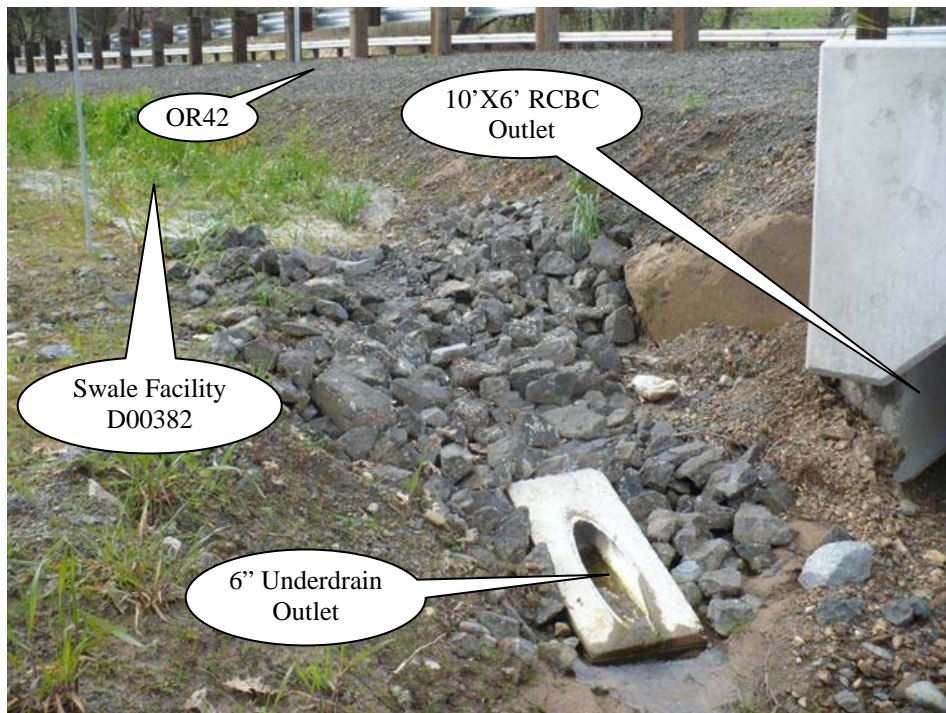

Photo 3: Looking west, flow from the swale and swale underdrain discharge directly into a small creek.

5. Facility Haz Mat Spill Feature(s)

Liquids can not be easily stored in this swale due to the wide and flat cross section design.

6. Auxiliary Outlet (High Flow Bypass)

Auxiliary Outlets are provided if the primary outlet control structure can not safely pass the projected high flows. Broad-crested spillway weirs and over flow risers are the two most common auxiliary outlets used in stormwater treatment facility design. The auxiliary outlet feature is either a part of the facility or an additional storm drain feature/structure.

The auxiliary outlet feature for this facility is:

- Designed into facility
- Other, as noted below
There is no auxiliary outlet for this facility.

7. Maintenance Requirements

Routine maintenance table for non-proprietary stormwater treatment and storage/detention facilities have been incorporated into ODOT's Maintenance Guide. These tables summarize the maintenance requirements for ponds, swales, filter strips, bioslopes, and detention tanks and vaults. Special maintenance requirements in addition to the routine requirements are noted below when applicable.

The ODOT Maintenance Guide can be viewed at the following website:

<http://www.oregon.gov/ODOT/HWY/OOM/MGuide.shtml>

Maintenance requirements for proprietary structures, such as underground water quality manholes and/or vaults with filter media are noted in Appendix C when applicable.

The following stormwater facility maintenance table (See ODOT Maintenance Guide) should be used to maintain the facility outlined in this Operation and Maintenance Manual or follow the Maintenance requirements outlined in Appendix C when proprietary structure is selected below:

- Table 1 (general maintenance)
- Table 2 (stormwater ponds)
- Table 3 (water quality biofiltration swales)

- Table 4 (water quality filter strips)
- Table 5 (water quality bioslopes)
- Table 6 (detention tank)
- Table 7 (detention vault)
- Appendix C (proprietary structure)
- Special Maintenance requirements:

Note: Special maintenance Requirements Require Concurrence from ODOT SR Hydraulics Engineer.

8. Waste Material Handling

Material removed from the facility is defined as waste by DEQ. Refer to the roadwaste section of the ODOT Maintenance Yard Environmental Management System (EMS) Policy and Procedures Manual for disposal options: <http://egov.oregon.gov/ODOT/HWY/OOM/EMS.shtml>

Contact any of the following for more detailed information about management of waste materials found on site:









ODOT Clean Water Unit	(503) 986-3008
ODOT Statewide Hazmat Coordinator	(503) 229-5129
ODOT Region Hazmat Coordinator	(541) 957-3594
ODEQ Northwest Region Office	(503) 229-5263

Appendix A

Content:

- **Operational Plan and Profile Drawing(s)**

LEGEND:

-  Photo Location / Direction
-  Water Quality Biofiltration Slope
-  Water Quality Biofiltration Swale
-  Manhole
-  Inlet
-  Storm Pipe (Facility)
-  Storm Pipe
-  Conveyance Direction
-  Pavement / Facility Flow Path

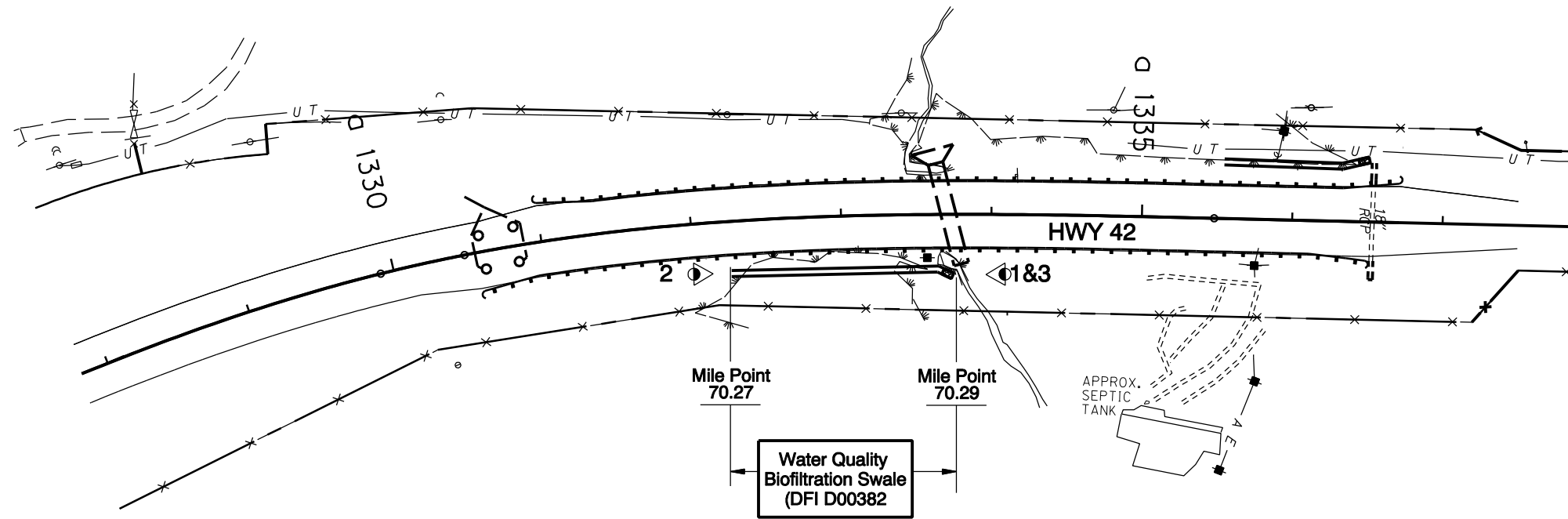
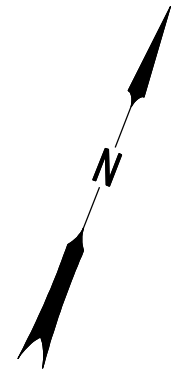

PLAN
N.T.S.

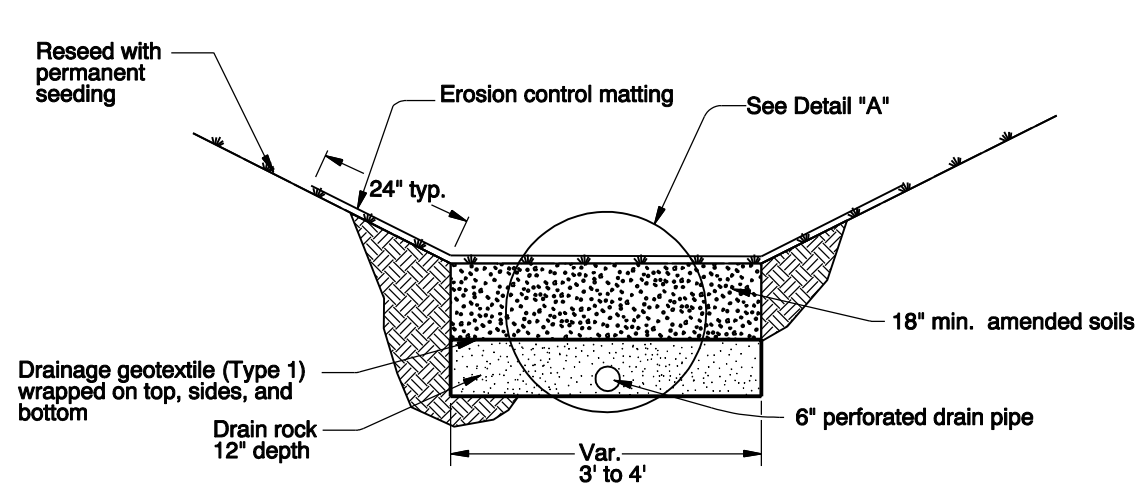

BIOFILTRATION SWALE W/ UNDER DRAIN
N.T.S.

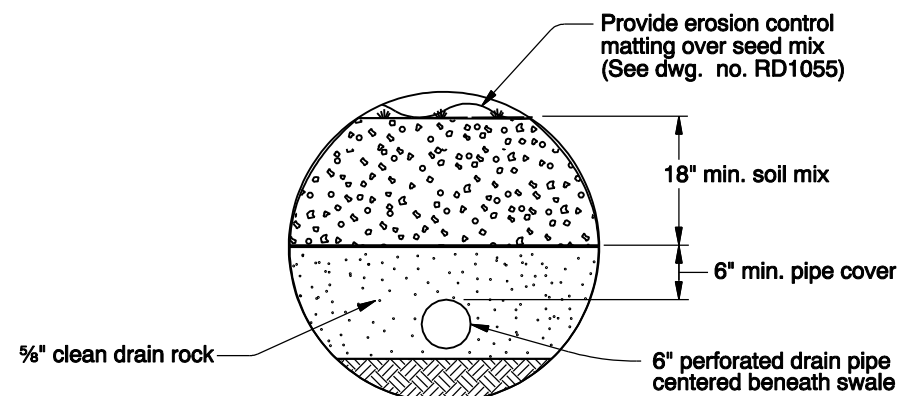

DETAIL "A"
N.T.S.

Prepared By: J. Carpenter
 Drafted By: B. Shafer

 **OREGON DEPARTMENT OF TRANSPORTATION**

DFI D00382
MAINTENANCE DISTRICT 7 HWY 035
WATER QUALITY BIOFILTRATION SWALE
 COOS BAY - ROSEBURG HIGHWAY MP 70.27/70.29
 DOUGLAS COUNTY

Appendix B

Content:

- **ODOT Project Plan Sheets**
 - *Cover/Title Sheet*
 - *Water Quality/Detention Plan Sheets*
 - *Other Details*

STATE OF OREGON
DEPARTMENT OF TRANSPORTATION

PLANS FOR PROPOSED PROJECT
GRADING, DRAINAGE, PAVING, & SIGNING

OR42: HOOVER HILL TO LOOKINGGLASS CREEK

COOS BAY - ROSEBURG HIGHWAY

**DOUGLAS COUNTY
FEBRUARY 2010**

INDEX OF SHEETS	
SHEET NO.	DESCRIPTION
1	Title Sheet
1A	Index Of Sheets Cont'd. & Std. Drg. Nos.

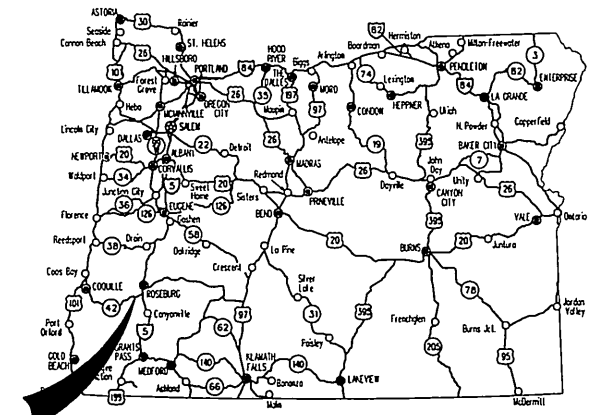

Overall Length Of Project - 3.2 Miles

ATTENTION:
Oregon Law Requires You To Follow Rules Adopted By The Oregon Utility Notification Center. Those Rules Are Set Forth In OAR 952-001-0010 Through OAR 952-001-0090. You May Obtain Copies Of The Rules By Calling The Center. (Note: The Telephone Number For The Oregon Utility Center Is (503) 232-1987.)

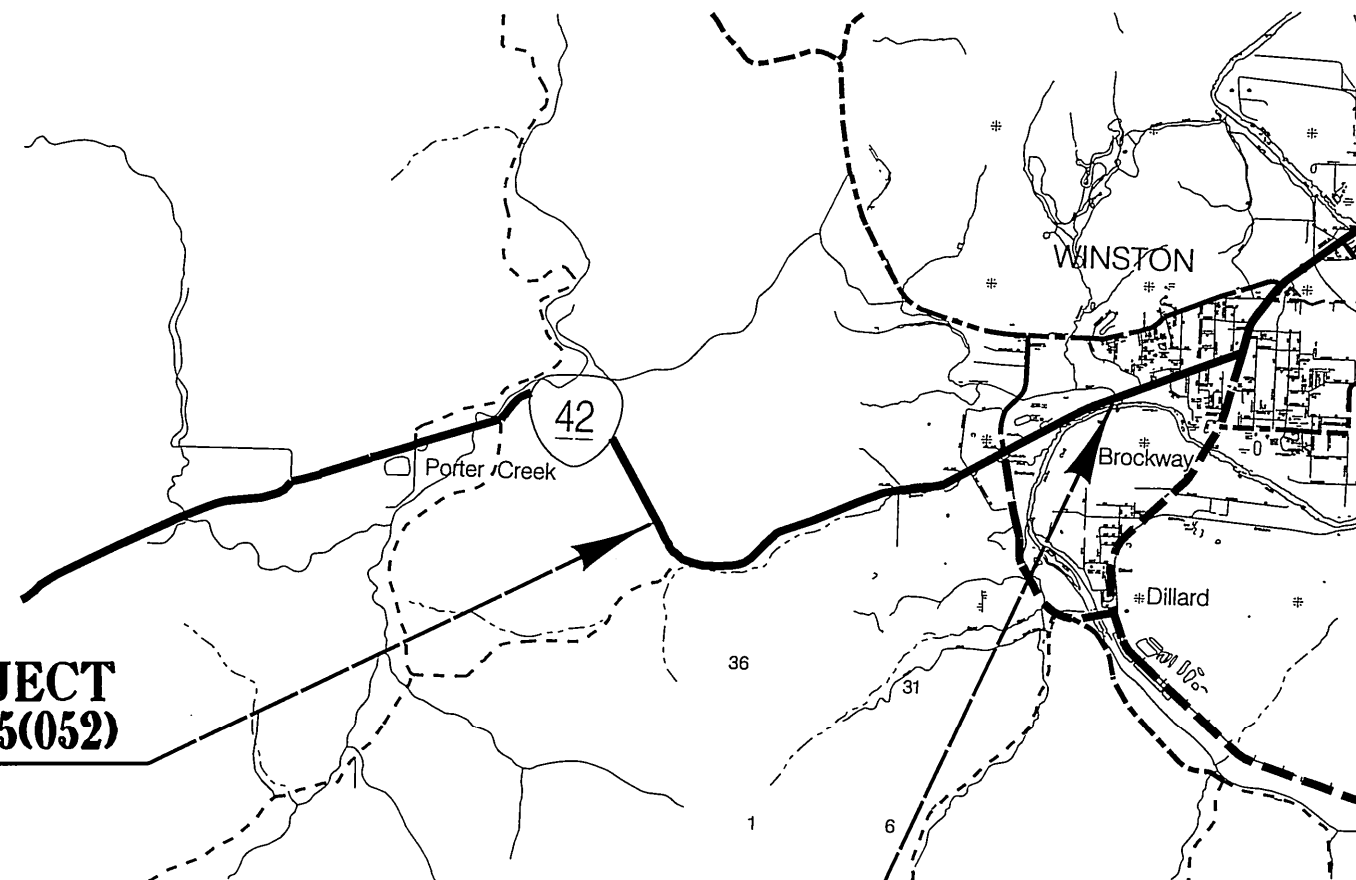

**BEGINNING OF PROJECT
STP-PLH-NH-HSIP-S035(052)
1282+50.0 (M.P. 69.32)**

**END OF PROJECT
STP-PLH-NH-HSIP-S035(052)
1451+24.0 (M.P. 72.52)**

T. 28 S., R. 6 & 7 W., SECT 25, 26, & 30 W.M.

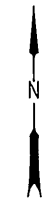

OREGON TRANSPORTATION COMMISSION

- Gail Achterman CHAIR
- Michael Nelson VICE-CHAIR
- Janice Wilson COMMISSIONER
- Alan Brown COMMISSIONER
- David Lohman COMMISSIONER
- Matthew L. Garrett DIRECTOR OF TRANSPORTATION

These plans were developed using ODOT design standards. Exceptions to these standards, if any, have been submitted and approved by the ODOT Chief Engineer or their delegated authority.

Approving Authority: *M. Thompson*
Signature & date 1/25/09

Mark Thompson Rg.3 Tech Ctr. Mgr.
Print name and title

Mark Thompson
Concurrence by ODOT Chief Engineer

**OR42: HOOVER HILL TO LOOKINGGLASS CREEK
COOS BAY - ROSEBURG HWY
DOUGLAS COUNTY**

FEDERAL HIGHWAY ADMINISTRATION	PROJECT NUMBER	SHEET NO.
OREGON DIVISION	STP-PLH-NH-HSIP-S035(052)	1



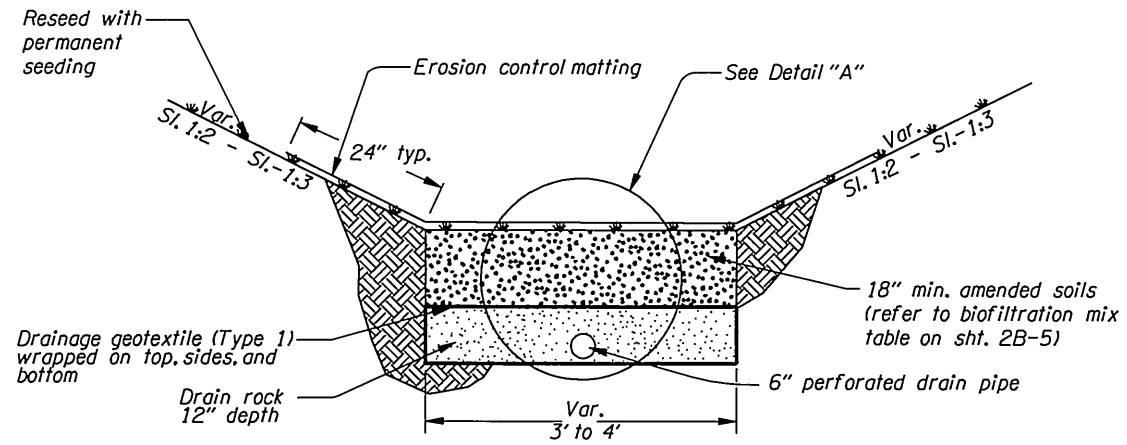

BIOFILTRATION SWALE W/ UNDER DRAIN
Not to scale

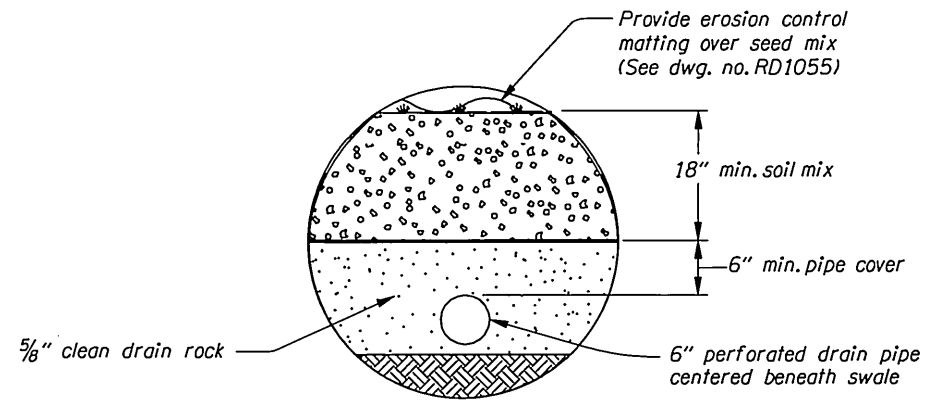

DETAIL "A"
Not to scale

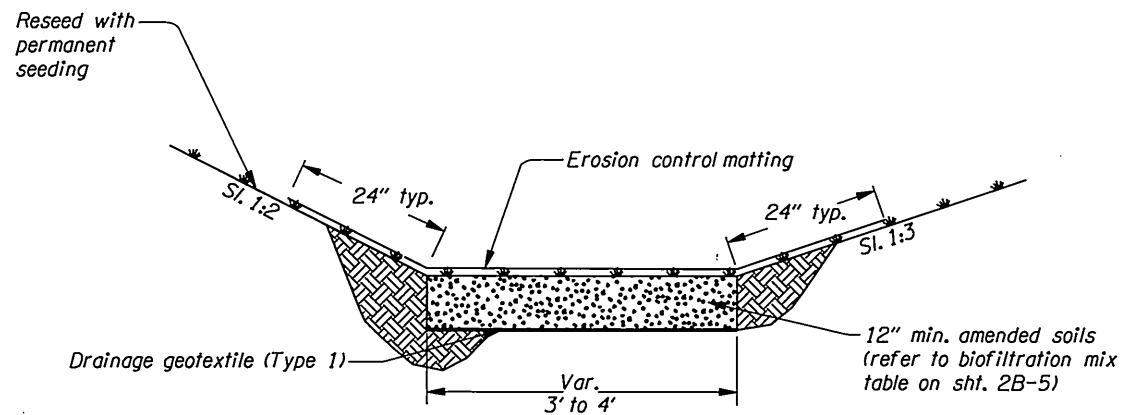

BIOFILTRATION SWALE
Not to scale

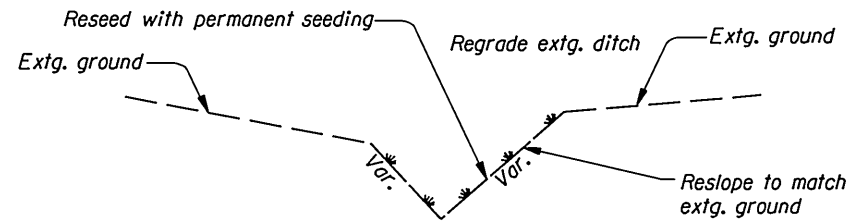

REGRADED EXISTING DITCH
Not to scale

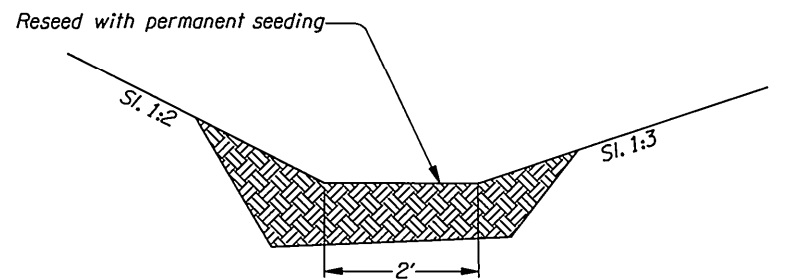

2' FLAT BOTTOM CONVEYANCE DITCH
Not to scale

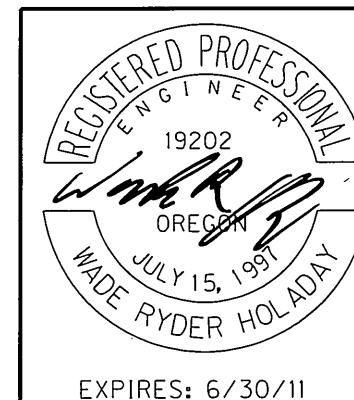

OREGON DEPARTMENT OF TRANSPORTATION

REGION 3 - TECHNICAL CENTER

OR42: HOOVER HILL TO LOOKINGGLASS CREEK
COOS BAY - ROSEBURG HWY
DOUGLAS COUNTY

Design Team Leader - James Burford
Designed By - Brian Banta
Drafted By - Billy Shafer

DETAILS

SHEET NO.

2B-3

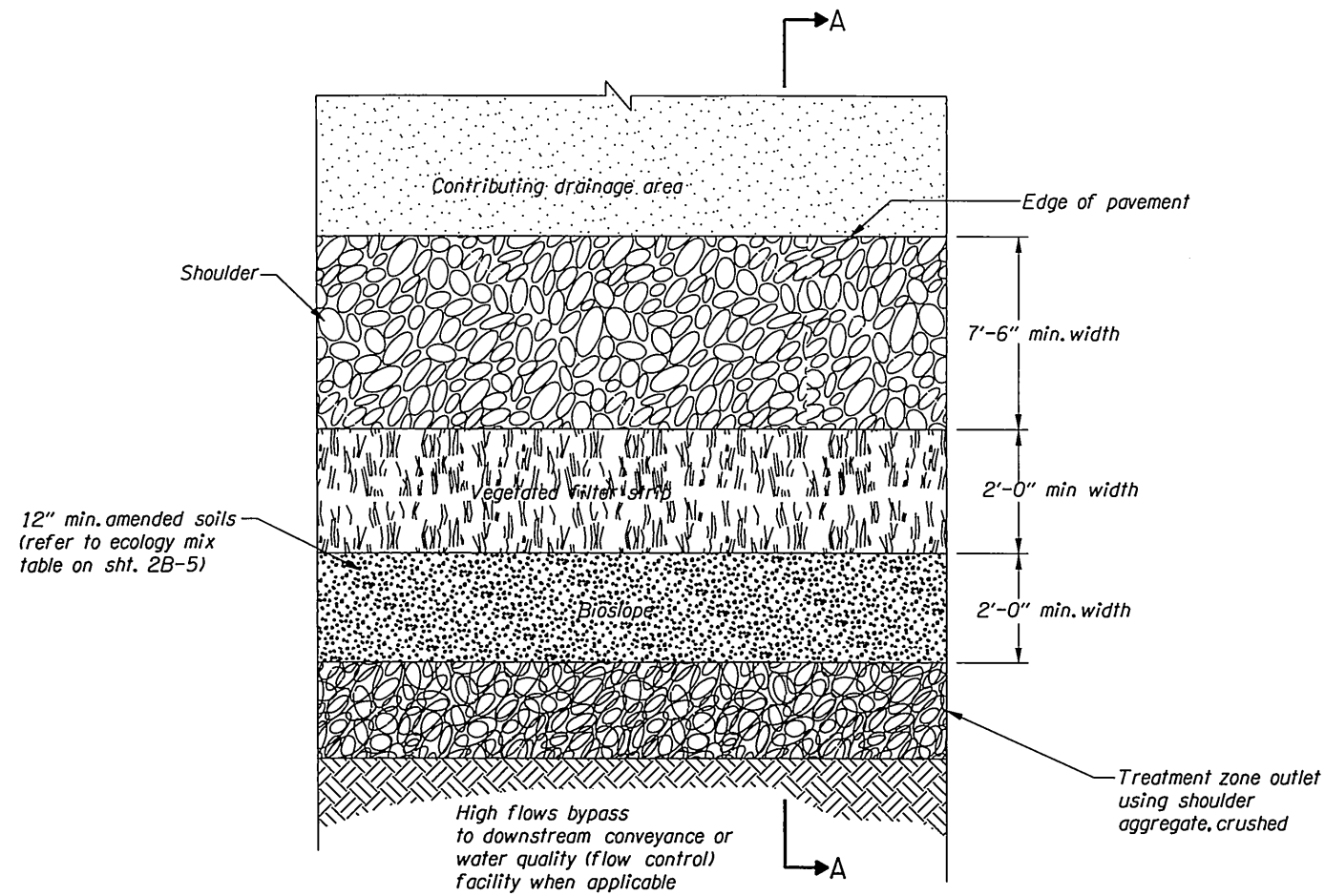

PLAN VIEW
Not to Scale

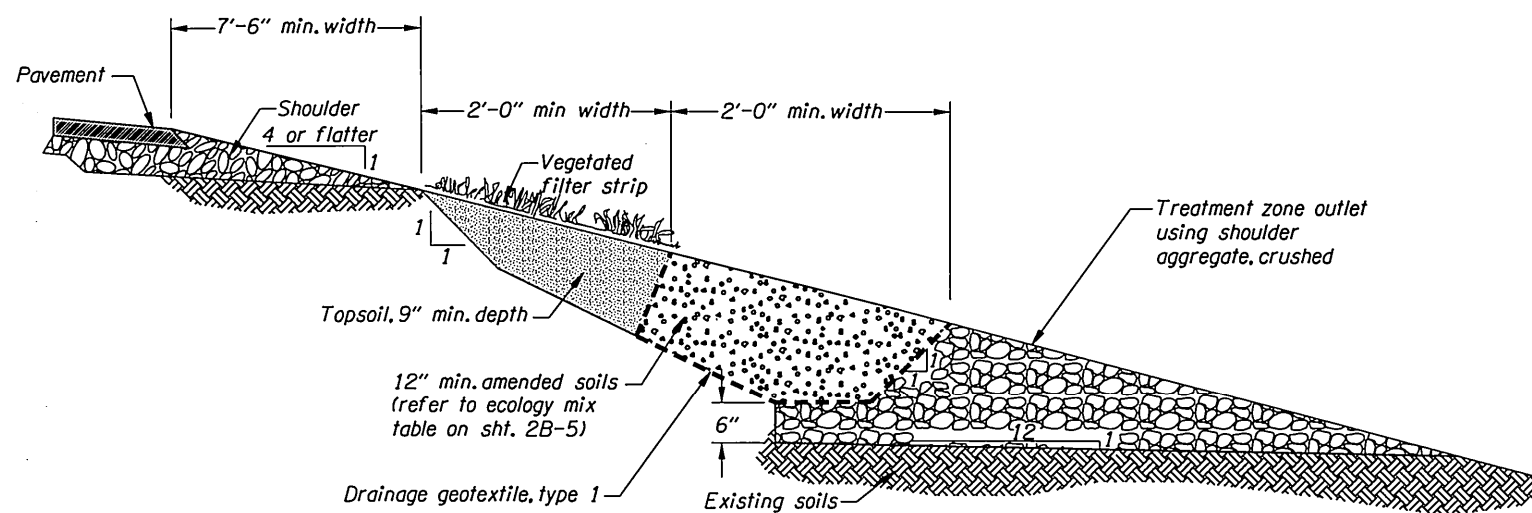

SECTION A-A
Not to Scale

BIOSLOPE DETAIL
Not to scale

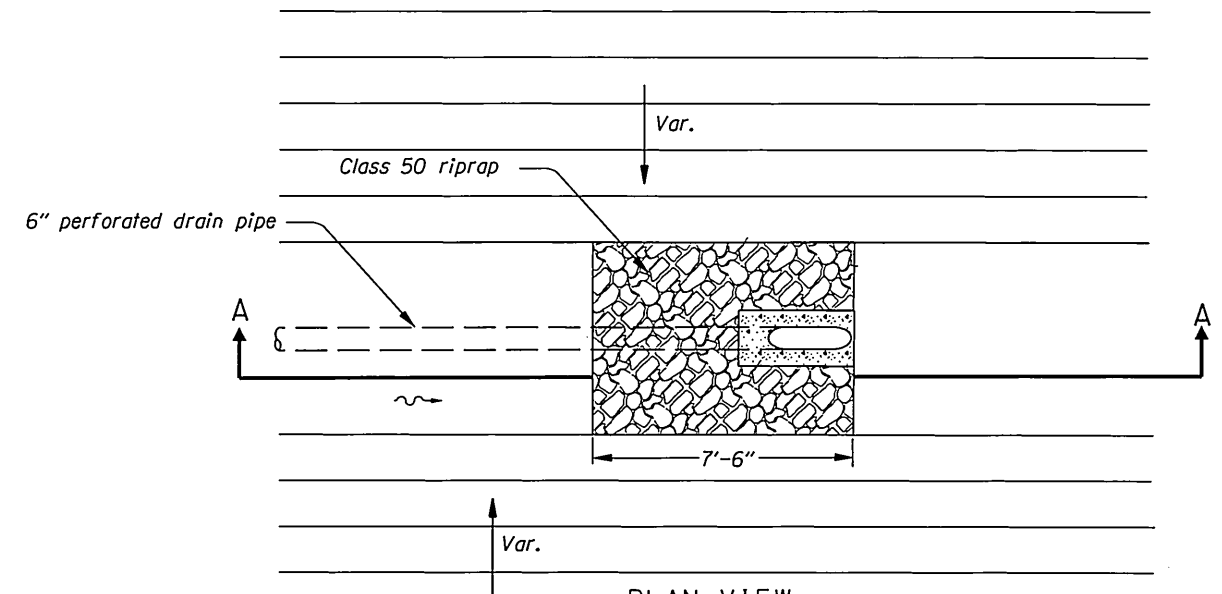

PLAN VIEW
Not to scale

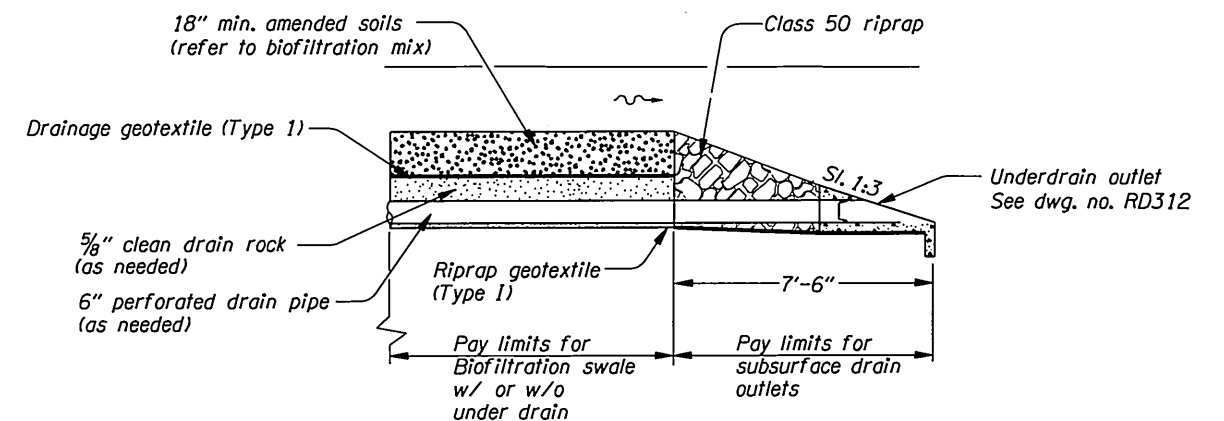

SECTION A-A
Not to scale

BIOFILTRATION SWALE END TREATMENT

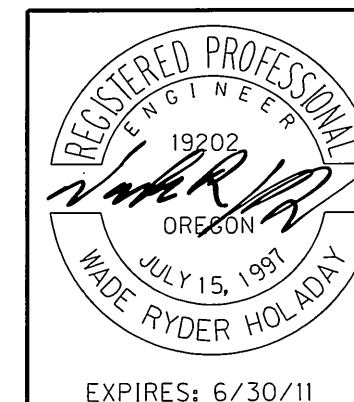

OREGON DEPARTMENT OF TRANSPORTATION

REGION 3 - TECHNICAL CENTER

OR42: HOOVER HILL TO LOOKINGGLASS CREEK
COOS BAY - ROSEBURG HWY
DOUGLAS COUNTY

Design Team Leader - James Burford
Designed By - Brian Banta
Drafted By - Billy Shafer

DETAILS

SHEET NO.

2B-4

ECOLOGY MIX TABLE

Use this mix for bioslopes

AMENDMENT	DESCRIPTION	MIX RATIO																
Aggregates	<p>Aggregates 3/8 inch to #10 sieve shall meet the following requirements:</p> <ul style="list-style-type: none"> • Tests: <ul style="list-style-type: none"> • Abrasion (Test Method T96) 35% max. • Oregon Air Aggregate Degradation 30% max. • Grading and quality: <table border="1"> <thead> <tr> <th>Sieve Size</th> <th>Percent Passing (by weight)</th> </tr> </thead> <tbody> <tr> <td>5/64" square</td> <td>100</td> </tr> <tr> <td>3/8" square</td> <td>90-100</td> </tr> <tr> <td>U.S. No. 4</td> <td>35-56</td> </tr> <tr> <td>U.S. No. 10</td> <td>0-10</td> </tr> <tr> <td>U.S. No. 200</td> <td>0-1.5</td> </tr> <tr> <td>% fracture, by weight, min.</td> <td>75</td> </tr> <tr> <td>Static stripping test</td> <td>Pass</td> </tr> </tbody> </table> • Fracture: At least one fractured face required on material retained on a No. 20 sieve if that sieve retains more than 5 percent of the total sample. • Finished product: Clean, uniform in quality, and free from wood, bark, roots, and other deleterious materials. • Aggregates: Substantially free from adherent coatings. The presence of a thin, firmly adhering film of weathered rock not be considered as coating unless it exists on more than 50% of the surface area of any size between successive laboratory sieves. 	Sieve Size	Percent Passing (by weight)	5/64" square	100	3/8" square	90-100	U.S. No. 4	35-56	U.S. No. 10	0-10	U.S. No. 200	0-1.5	% fracture, by weight, min.	75	Static stripping test	Pass	3 cubic yards (c.y.)
Sieve Size	Percent Passing (by weight)																	
5/64" square	100																	
3/8" square	90-100																	
U.S. No. 4	35-56																	
U.S. No. 10	0-10																	
U.S. No. 200	0-1.5																	
% fracture, by weight, min.	75																	
Static stripping test	Pass																	
Perlite	<ul style="list-style-type: none"> • Horticulture grade, free of any toxic materials • Size gradation: <ul style="list-style-type: none"> • Min 70% retained by a No. 18 sieve • Max. 10% smaller than that which passes through a No. 30 sieve. 	1 cubic yard per 3 cubic yards of aggregate																
Dolomite	<ul style="list-style-type: none"> • Calcium magnesium carbonate - $CaMg(CO_3)_2$ • Agriculture grade, free of any toxic materials • Size gradation: 100% passes through a No. 8 sieve and 100% retained by a No. 16 sieve. 	10 pounds per 1 c.y. of Perlite																
Gypsum	<ul style="list-style-type: none"> • Non-calcined, agricultural gypsum - $CaSO_4 \cdot 2H_2O$ (hydrated calcium sulfate) • Agriculture grade, free of any toxic materials • Size gradation: 100% passes through a No. 8 sieve and 100% retained by a No. 16 sieve. 	1.5 pounds per 1 c.y. of Perlite																

BIOFILTRATION MIX TABLE

Biofiltration mix is used for the treatment zone along the entire biofiltration swale bottom to remove pollutants as stormwater runoff drains through this media mix. General design criteria includes:

- The minimum depth is 12 inches
- The biofiltration mix consists of the following materials:

MEDIUM	DESCRIPTION	PERCENTAGE OF MEDIUM IN FILTER LAYER
Sand	<ul style="list-style-type: none"> • Coarse grade with an effective particle size (D10) of 0.012" - 0.20" (0.3 - 0.5 mm) • Uniformity coefficient of less than 4 • Washed 	40% - 50%
Topsoil	<ul style="list-style-type: none"> • Loam or loamy sand texture per USDA Soil Textural Classification • Clay content of less than 5% 	30% if loam or 40% if loamy sand
Compost	Coarse compost conforming to special provision 01040.15(b)	20% - 30%
Total Composition		100%
Total Organic Matter Content	Measured per ASTM Designation D2974 (Standard test method for Moisture, Ash and Organic Matter of Peat and other organic soils)	Approx. 10% by dry weight



OREGON DEPARTMENT OF TRANSPORTATION	
REGION 3 - TECHNICAL CENTER	
OR42: HOOVER HILL TO LOOKINGGLASS CREEK COOS BAY - ROSEBURG HWY DOUGLAS COUNTY	
Design Team Leader - James Burford Designed By - Brian Banta Drafted By - Billy Shafer	
DETAILS	SHEET NO. 2B-5

Sec. 30, T. 28 S, R. 6 W, W.M.

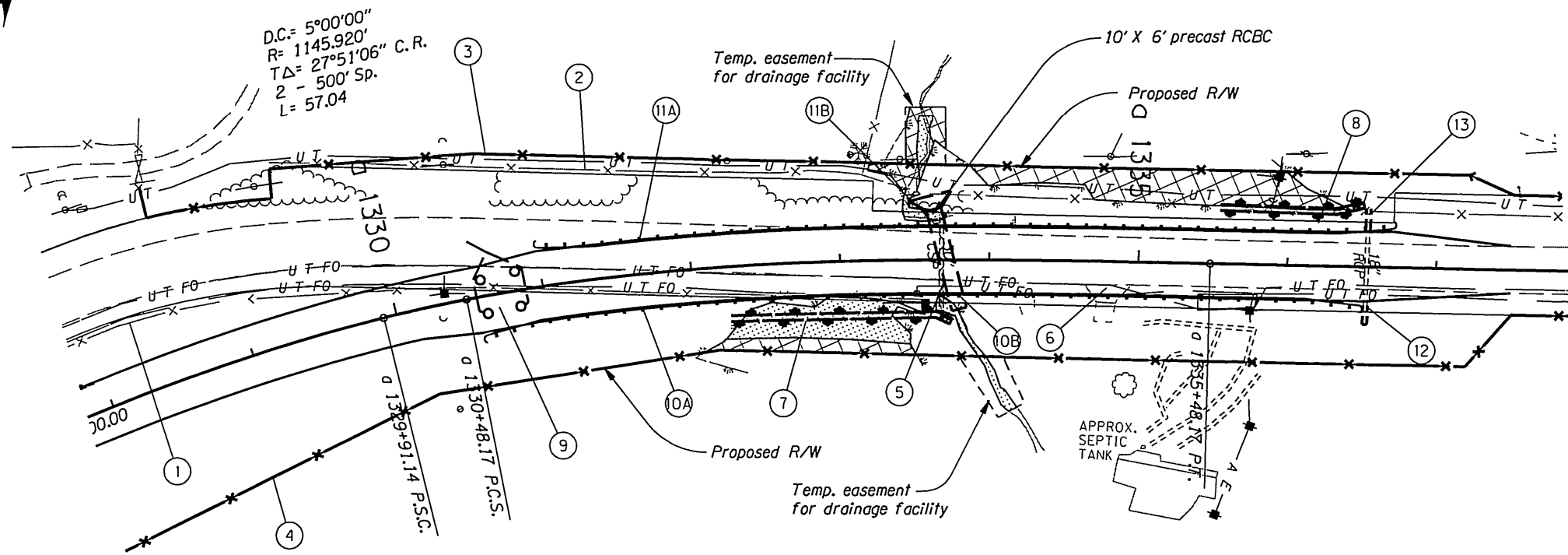

- ① See sht. 6, note 12
- ② Sta. "C" a 1329+46.0, Lt. to Sta. "C" a 1340+35.0, Lt. Remove extg. fence - 1144'
- ③ See sht. 6, note 6
- ④ See sht. 6, note 8
- ⑤ Sta. "C" a 1333+60.8, Lt. to Sta. "C" a 1333+82.4, Lt. Remove extg. pipe - 54'
Inst. 10' X 6' precast reinf. conc. box culvert - 69.0'
S= .0335 ft/ft
I.E. (in) 635.99'
I.E. (out) 633.68'
Const. wingwalls and apron
(For details see shts. GE-3 & GE-9)
(See dwg. nos. BR800)
- ⑥ Sta. "C" a 1334+79.0, Rt. Remove approach
- ⑦ Sta. "C" a 1332+49.0, Rt. to Sta. "C" a 1333+75.0, Rt. Const. biofiltration swale w/underdrain, 4' width - 150'
Inst. subsurface drain outlet
(For details see shts. 2B-3 & 2B-4)
- ⑧ Sta. "C" a 1335+53.6, Lt. to Sta. "C" a 1336+52.3, Lt. Const. biofiltration swale w/underdrain, 4' width - 98'
Inst. subsurface drain outlet
(For details see shts. 2B-3 & 2B-4)
- ⑨ Sta. "C" a 1330+90.0 Install traffic counter/classifier
(For details see shts. TDS-10-006A and TDS-10-006B)
- ⑩A Sta. "C" a 1330+57.1 Rt. to Sta. "C" a 1336+48.9, Rt. Const. guardrail - 475' (Type 2A)
Const. guardrail terminals, non-flared - 2
W=2', E=2'
- ⑩B Sta. "C" a 1330+63.0 Rt. to Sta. "C" a 1334+00.5, Rt. Const. guardrail - 37.5' (Type 2A, modified)
(See dwg. no. RD470)

- ⑪A Sta. "C" a 1331+00.0 Lt. to Sta. "C" a 1336+70.6, Lt. Const. guardrail - 462.5' (Type 2A)
Const. guardrail terminals, non-flared - 2
W=2', E=2'
- ⑪B Sta. "C" a 1333+44.0 Lt. to Sta. "C" a 1333+81.5, Lt. Const. guardrail - 37.5' (Type 2A, modified)
- ⑫ Sta. "C" a 1336+52.6, Rt. to Sta. "C" a 1336+52.8, Rt. Inst. 18" culv. - 13'
5' depth
connect to extg. culvert
S=.005 ft./ft.
I.E. (in) = 633.48'
I.E. (out) = 633.41'
Inst. paved culvert end slope - 35 sq. ft.
Const. sloped end section 18" - 1 ea.

- ⑬ Sta. "C" a 1336+53.6, Lt. to Sta. "C" a 1336+53.8, Lt. Inst. 18" culv. - 15'
5' depth
connect to extg. culvert
S=.072 ft./ft.
I.E. (in) = 635.90'
I.E. (out) = 634.82'
Inst. paved culvert end slope - 35 sq. ft.
Const. sloped end section 18" - 1 ea.

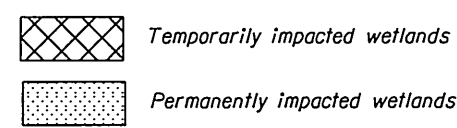

No Work Zone areas apply to the hatched areas shown, all areas outside state right of way or easements, and all undisturbed areas outside the roadway prism between Brockway Rd. and Lookingglass Creek Bridge

REGISTERED PROFESSIONAL ENGINEER
 69460PE
Brian L. Banta
 OREGON
 NOV. 13, 2007
 BRIAN LEE BANTA
 EXPIRES: 12-31-2011

OREGON DEPARTMENT OF TRANSPORTATION	
REGION 3 - TECHNICAL CENTER	
OR42: HOOVER HILL TO LOOKINGGLASS CREEK COOS BAY - ROSEBURG HWY DOUGLAS COUNTY	
Design Team Leader - James Burford Designed By - Brian Banta Drafted By - Billy Shafer	
GENERAL CONSTRUCTION	SHEET NO. 7