

Part 200 Geometric Design and Context

Section 201 Introduction

This section presents the primary design controls and criteria that are integral to the development of any highway project. Standards are presented for design speed, horizontal and vertical alignment, superelevation, sight distance, and grades. Understanding the traffic characteristics, providing for all transportation modes, selecting the appropriate design vehicle and design speed, and determining the access management strategy are all key to successfully delivering a project that meets the goals and values of practical design and design flexibility. Each of these design controls and criteria are discussed separately in the following sections for the different roadway functional classifications, both urban and rural; however, the intent is that all these considerations should be taken holistically for the best possible outcome. As with any project, the practical application of these standards will depend on the purpose, need, context, and unique constraints of the project.

This section also discusses the context of a roadway in relationship to roadway functional classification and the state highway classification, the flexibility in design depending on the context, while keeping in mind and collaborating with other areas of the Department such as operations, maintenance, and safety resulting in a design that provides a long service life.

With the incorporation of the Blueprint for Urban Design (BUD) into the HDM, there are six urban contexts that are similar to the past HDM Oregon Highway Plan segment designations. These different contexts and their relationship to each other are discussed in Section 203 through Section 207.

Because of the multiple urban contexts and their integration with design, a large portion of Part 200 is dedicated to describing the urban context, flexibility, and trade-offs within the urban environment. This does not distract from the importance of rural design and rural geometric design. Design controls and criteria are equally important in a rural environment as well, where design speeds are generally higher.

Text within some parts of this manual is presented in specific fonts that show the required documentation and/or approval if the design does not meet the requirements shown.

Table 200-1 shows the four text fonts used that include Standard, Guidance, Option, and General Text along with their descriptions.

Standard - A statement of required, mandatory, or specifically prohibitive practice regarding a roadway geometric feature or appurtenance. All Standard statements appear in bold type in design parameters. The verb “provide” is typically used. The adjective “required” is typically used in figures to illustrate Standard statements. The verbs “should” and “may” are not used in Standard statements. The adjectives “recommended” and “optional” are only used in Standard statements to describe recommended or optional design features as they relate to required design features. Standard statements are sometimes modified by Options. A design exception is

required to modify a Standard. The State Traffic-Roadway Engineer (STRE) gives formal approval, and FHWA approves as required.

Table 200-1: Font Key

Font Key Term	Font	Deviations	Approver
Standard	Bold text	Design Exceptions	State Traffic-Roadway Engineer (STRE) and for some projects, FHWA
Guideline	<i>Bold Italics text</i>	Design Decisions Document	Region with Tech Expert input
Option	<i>Italics Text</i>	Document decisions	Engineer of Record (EOR)
General Text	Not bold or italics	N/A	N/A

Guideline - A statement of recommended practice in typical situations. All Guideline statements appear in bold italicized type in design parameters. The verb “should” is typically used. The adjective “recommended” is typically used in figures to illustrate Guideline statements. The verbs “provide” and “may” are not used in Guideline statements. The adjectives “required” and “optional” are only used in Guideline statements to describe required or optional design features as they relate to recommended design features. Guideline statements are sometimes modified by Options. While a formal design exception is not required, documentation of the decisions made by the Engineer of Record in the Design Decision documentation or other engineering reports is required. Region approval, with input from Technical Experts, is formally recorded for urban projects via the Urban Design Concurrence Document in the Design Decision portion. The Urban Design Concurrence document is located on the Highway Design Manual website.

Option - A statement of practice that is a permissive condition and carries no requirement or recommendation. Option statements sometimes contain allowable ranges within a Standard or Guideline statement. All Option statements appear in italic type in design parameters sections. The verb “may” is typically used. The adjective “optional” is typically used in figures to illustrate Option statements. The verbs “shall” and “should” are not used in Option statements. The adjectives “required” and “recommended” are only used in Option statements to describe required or recommended design features as they relate to optional design features. While a formal design exception is not required, documentation of the decisions made by the Engineer of Record in the Design Decision documentation or other engineering reports is best practice.

General Text - Any informational statement that does not convey any degree of mandate, recommendation, authorization, prohibition, or enforceable condition. The remaining text in the manual is general text and may include supporting information, background discussion, commentary, explanations, information about design process or procedures, description of methods, or potential considerations and all other general discussion. General text statements do not include any special text formatting. General text may be used to inform and support design exception requests, particularly where narrative explanations show best practices or methods of design that support the requested design exception.

201.1 Definitions

Design Speed - The selected speed used to determine the various geometric design features of the roadway.

Target Speed - The speed set as a project goal. The intended operating speed.

Target Speed (ITE Definition) - The highest operating speed at which vehicles should ideally operate on a roadway in a specific context.

Target Speed (AASHTO Working Definition) - The operating speed that the designer intends for drivers to use.

Operating Speed - The speed at which vehicles are observed operating during free flow conditions

Running Speed - A vehicle's speed determined by dividing the distance traveled by the time duration, excluding delays.

85th Percentile Speed - The speed at or below which 85 percent of the drivers operate their vehicles, based on a speed study.

Green Book - AASHTO publication "A Policy on Geometric Design of Highways and Streets".

201.2 Acronyms

AASHTO - American Association of State Highway and Transportation Officials

CCD - Commerce and Compliance Division

FHWA - Federal Highway Administration

MCTD - Motor Carrier Transportation Division

PODI - Projects of Division Interest

Section 202 Approval Processes

202.1 Design Exceptions

Any deviation from any design standard requires a design exception approved by the State Traffic-Roadway Engineer. A design exception requires signatures from both the Engineer of Record (EOR) and State Traffic-Roadway Engineer. Design exceptions and the design exception process are addressed in Part 1000 of the HDM. Design exceptions may also require approval by the Federal Highway Administration (FHWA) for projects of interest they choose to review. Currently, these projects are called Risked Based Involvement Projects (RBIP). Previously, these projects were classified by FHWA as Projects of Division Interest or PODI.

202.2 Design Concurrence Document

The Blueprint for Urban Design (BUD), which has been incorporated into the HDM, established the urban design concurrence document form to determine project context, define design criteria, and document design decisions. *Authority for approval of the urban design concurrence document will reside in the Region Technical Center.* The Region Technical Center Manager shall provide final approval of design concurrence with collaborative input from region planning, traffic, roadway, and maintenance sections.

Section 203 Context and Classification

203.1 Urban Context and Roadway Classifications

This section describes the ODOT Urban Context system to differentiate the variety of urban areas and unincorporated communities in Oregon. The urban context of a roadway, together with its transportation characteristics, will provide information about the types of users expected along the roadway, regional and local travel demand of the roadway, and the challenges and opportunities of each roadway user. The urban context and transportation characteristics of a roadway will determine key design guidance and criteria for state roadways in urban areas. The six ODOT defined urban contexts of Traditional Downtown/Central Business District, Urban Mix, Commercial Corridor, Residential Corridor, Suburban Fringe, and Rural Community primarily relate to arterials, collectors and local roads with at-grade intersections. Design of interstate highways, limited-access freeways, expressways with interchanges, or other similarly operating arterials with grade separated facilities are not

included within these six context types. They have a context of their own that focuses on maintaining through-trip motor vehicle mobility as a primary function. These are generally higher speed roadways that serve as connections between destinations and are often access controlled. However, the crossroad or cross street between ramp terminals of an interstate or limited access freeway, grade separated expressway/arterial is not considered part of the interstate, freeway, or expressway/arterial, but rather part of the urban network. Although the crossroad of an interstate highway, limited access freeway, or grade-separated expressway/arterial may be located in an urban context, the intended mobility and high-level operation of the interstate highway, limited access freeway, or grade-separated expressway/arterial needs to be maintained. While ramp access and mobility are important for interstate, freeway, and expressway operation, in urban locations, some queuing may be desirable to allow for needed modal operations focused on the crossroad between the ramp terminals. There needs to be a balance between ramp operations, freeway mobility and the urban street network for overall safety of all road users. This section describes how to determine the urban context of an ODOT roadway and what additional transportation characteristics are considered when planning and designing a roadway. This will expand ODOT's context-sensitive approach for planning, design, and operations of projects in urban areas that serve all users.

203.2 Design Flexibility in Urban Contexts

ODOT'S Performance-Based Practical Design aligns with national design trends and is set to follow FHWA direction as well as future updates to the AASHTO Green Book. The Performance-Based Practical Design process builds on ODOT's Practical Design strategy developed in 2010 and provides additional guidance for practitioners to use design flexibility to implement designs that are appropriate within each urban context described in Section 207 and Section 208. The process includes guidance to help practitioners identify and evaluate the final design, while considering operations, safety, and maintenance as well when determining criteria for urban projects. *While the Highway Design Manual is a primary source for project design, inter-disciplinary scoping and project development teams need to utilize all ODOT resources and tools for evaluating design, operation, maintenance, and safety to balance trade-offs in order to integrate the needs of each modal group and develop solutions that meet the desired outcomes of a project.* Part 300, Section 303 introduces the cross section realms and provides specific considerations to the design elements within each realm as it relates to urban projects. In addition, the summary tables within Part 300, Section 304 provide design guidance recommendations for ODOT urban projects. The Urban Design Concurrence document provides documentation of the project decision process and provides reasoning for the proposed project design, along with background information that pertains to the established project goals and outcomes.

203.3 Integrating Design, Operations, Maintenance, and Safety

Designing multimodal transportation facilities in urban areas is inherently complex. While past design trends have emphasized adherence to strict design standards, current urban design strategies highlight flexibility in design and emphasize the need to identify project goals and performance measures that align with the intended project outcomes. Project teams involved with urban design projects are tasked with balancing the needs and priorities of a variety of roadway users while integrating design principles, operations, maintenance tasks, and safety. Understanding and executing a performance-based approach within each stage of the project development process enables project teams to make informed decisions about the performance trade-offs. This is especially helpful when developing solutions in fiscally and physically constrained environments. National activities and associated publications, such as the FHWA Performance-Based Practical Design initiatives and the NCHRP Report 785: Performance-Based Analysis of Geometric Design of Highways and Streets, have resulted in a framework for how to integrate design, operations, and safety by evaluating the overall performance of a project.

Balancing the trade-offs by integrating design, operations, maintenance tasks, and safety for all modal groups involves using relevant, objective data to support the design decisions. This will require an awareness of the resources available to quantify specific performance measures or qualitatively describe the anticipated effect of a given roadway or intersection. Evaluating the trade-offs within a constrained roadway environment and balancing the needs of various modal users can be particularly challenging in an urban area. Along with federal design publications, the ODOT HDM is the primary resource for detailed design guidance providing flexibility in urban highway design in relation to land use and community-based decision processes. While in the past the primary project focus was motor vehicle operations, there are now resources and tools to guide practitioners in multimodal analysis and evaluating the needs for each user from an operational perspective. Both FHWA and ODOT recognize information found in resources outside federal or Oregon DOT publications. Some of these include publications from other state DOTs, guides developed by national organizations like the National Association of City Transportation Officials (NACTO), the Institute of Transportation Engineers (ITE), and the American Society of Civil Engineers (ASCE), as well as information provided by many other transportation engineering resources. *While outside resources may be utilized for information purposes, the Oregon Highway Design Manual is the deciding factor for design of highways, roads and streets on the Oregon state highway system.*

Whether or not safety is the catalyst for a project, conducting safety analysis can help identify areas for improving the roadway for various modal users. ODOT seeks to provide safe transportation to each roadway user and continues to work towards reducing fatal and severe injury crashes on state facilities. Therefore, using safety performance measures or qualitative assessment of safety is often a focus when evaluating project alternatives and assessing project

trade-offs. Practitioners can reference the Oregon Pedestrian and Bicycle Safety Implementation Plan for additional guidance and resources. In addition to modal, safety and operational needs, the Maintenance role in a facility's life cycle is an important one. Designing and constructing a facility that is difficult to maintain will not provide adequate long-term service and can degrade modal safety and operations over time.

Urban roadway facilities are designed and operated to enable safe access for all users, including pedestrians, bicyclists, motorists, and transit riders of all ages and abilities. The design team evaluates the difference between “accommodating” versus “designing for” a given mode and applies consistent principles within the project context. Multimodal design considerations depend on the intended function of the corridor, as well as balancing trade-offs and objectives from local plans. For example, consider a roadway designed primarily for mobility for motorized vehicles. The design is required to “accommodate” other users, such as pedestrians and bicycles, but it will not attract a wide range of vulnerable users. A roadway intended to serve and attract non-auto users, however, is “designed for” multimodal users. This means mobility for motorized vehicles takes a lower design need and is “accommodated”, possibly allowing increased congestion as the trade-off.

With an understanding of the overall project performance, including maintenance needs, a project team can begin to evaluate the design element application based on the integration of design, operations, and safety. Subsequent sections of Part 300 provide guidance for integrating design, safety and operations in conjunction with maintenance needs and provide potential tools for measuring and evaluating the considerations and trade-offs between design elements. Section 205 and Section 206 provide information and recommendations for each ODOT Urban Context. In conjunction with Sections 303 and 304, they provide design guidance for roadway cross-sections within the various contexts and provide the next level of detail by discussing the range of considerations for design elements within the roadway cross-section, which are organized into “cross-section realms”.

203.4 Resources for Design, Operations, and Safety

Balancing the trade-offs by integrating design, operations, maintenance tasks, and safety for all modal groups involves using relevant, objective data to support the design decisions. This will require an awareness of the resources available to quantify specific performance measures or qualitatively describe the anticipated effect of a given roadway or intersection. Long term maintenance tasks must also be considered in the final design. The Maintenance Section plays a significant role in making sure ODOT's facilities function as they were designed. The Maintenance role in a facility's life cycle is an important one. Designing and constructing a

Specific safety calibration factors developed for the State of Oregon can help practitioners better apply the predictive safety methods in the Highway Safety Manual to address project safety outcomes.

facility that is difficult to maintain will not provide adequate long-term service. Other recently published research, such as NCHRP Report 880: Design Guide for Low-Speed Multimodal Roadways, also provide a useful resource for considering design trade-offs in an urban environment.

Whether or not safety is the catalyst for a project, conducting safety analysis can help identify areas for improving the roadway for various modal users. ODOT seeks to provide safe transportation to each roadway user and continues to work towards reducing fatal and severe injury crashes on state facilities. Therefore, using safety performance measures or qualitative assessment of safety is often a focus when evaluating project alternatives and assessing project trade-offs. There are limitations in the bicycle and pedestrian crash data available at ODOT. Practitioners can reference the Oregon Pedestrian and Bicycle Safety Implementation Plan for additional guidance and resources.

Evaluating the trade-offs within a constrained roadway environment and balancing the needs of various modal users can be particularly challenging in an urban area. The ODOT HDM is the primary resource for detailed design guidance and discusses the flexibility in highway design in relation to land use and community-based decision processes. While in the past the primary project focus was motor vehicle operations, there are now resources and tools to guide practitioners in multimodal analysis and evaluating the needs for each user from an operational perspective.

Section 204 Roadway Classification

The following guidance discusses the different types of roadway classifications and contexts including: the federal functional classification, ODOT's state highway classification, the OHP highway segment designations and non-designated segments, other roadway designations such as freight routes and reduction review routes, and, most recently, ODOT's six urban contexts.

The classification and context guidance needs to be considered holistically by the designer as the Highway Design Manual has developed the design standards based upon the federal functional classifications including freeways; expressways; rural arterials, collectors and local routes; and urban arterials, collectors, and local routes. ODOT has further developed the urban functional classification into the following six urban contexts: traditional downtown/central business district; urban mix; commercial corridor; residential corridor; suburban fringe; and rural community. The six urban contexts are not necessarily based on being within the urban growth boundary, but rather, the surrounding context of the roadway in question. These six urban contexts and related design guidance are not to be used in the design of interstate highways or other limited-access freeways, grade separated Oregon Highway Plan designated expressways or other similarly operating arterials with interchanges. In respect to interchanges and depending on the style of interchange, the appropriate design context will need to be determined for the crossroad between the ramp terminals.

204.1 Oregon Highway Plan Classifications

ODOT currently uses a highway classification system that divides state highways into five primary categories: Interstate, Statewide, Regional, District, and Local Interest Roads. Table 200-2 shows ODOT's definitions and objectives for these classifications. ODOT uses the state highway classification system to guide management and investment decisions regarding state roadway facilities. The state highway classifications provide information on the role of roadways related to mobility and access, as well as limited guidance regarding the prioritization of roadway users.

When planning in urban areas, the urban context is the primary basis of planning and design decisions. The state roadway designation would be a secondary basis of planning and design decisions.

Table 200-2 State Highway Classifications (OHP)

State Highway Classification	Primary Function	Secondary Function	Objective
Interstate Highways	Provide connections to major cities, regions of the state, and other states.	Provide connections for regional trips within metropolitan areas	Provide for safe and efficient high-speed continuous-flow operation in urban and rural areas. Includes managed access.
Statewide Highways	Provide inter-urban and inter-regional mobility and connections to larger urban areas, ports, and major recreation areas	Provide connections for intra-urban and intra-regional trips	Provide safe and efficient, high-speed, continuous-flow operations
Regional Highways	Provide connections and links to regional centers, Statewide or Interstate Highways, or economic or activity centers of regional significance	Serve land uses in the vicinity of these highways	Provide safe and efficient, moderate to high-speed operations
District Highways	Provide connections and links between small urbanized areas, rural centers and urban hubs ¹ , and serve local access and traffic	N/A	Provide for safe and efficient, moderate to high-speed continuous-flow operation in rural areas ² and moderate to low-speed operation in urban and urbanizing areas ¹ for traffic flow and for pedestrian and bicycle movements
Local Interest Roads	Local streets or arterials serving little or no purpose for through traffic mobility	N/A	Provide for safe and efficient, low to moderate speed traffic flow and for pedestrian and bicycle movements.

Source: 1999 Oregon Highway Plan

¹ Small urbanized areas, rural centers, and urban hubs described in the OHP are all considered urban. Their urban context would be classified based on the characteristics described in Section 207.

² Adding flexibility to the Statewide and Regional Highway classifications allows for low to moderate speeds in urban contexts and to further support safe movement of bicyclists and pedestrians. Currently, District Highways have different objectives in urban and rural areas; context and design flexibility provides the same opportunity for Statewide and Regional Highways.

A subset of the five OHP classifications outlined above are roadways designated by the Oregon Transportation Commission as expressways. The OHP defines expressways as complete routes or segments of existing two-lane and multi-lane highways and planned multi-lane highways that provide for safe and efficient high speed and high volume traffic movements. Their

primary function is to provide for interurban travel and connections to ports and major recreation areas with minimal interruptions. A secondary function is to provide for long distance intra-urban travel in metropolitan areas. In urban areas, speeds are moderate to high. In rural areas, speeds are high.

204.2 Other Roadway Designations or Characteristics

While context and OHP roadway classification can provide general guidelines for the type and activity level of different users, there are other roadway designations or characteristics that impact planning and design of roadways in urban areas. Table 200-3 summarizes some of these additional factors and the design criteria they can potentially affect. Section 207 provides more details related to how specific design elements are impacted by these designations or characteristics.

Table 200-3 Designations/Characteristics Impacting Design Decisions

Factors	Data Sources	Affected Design Criteria
Reduction Review Route	<ul style="list-style-type: none"> • ODOT designation – defined and stipulated by statute; ORS 366.215 and OAR 731-012 	<ul style="list-style-type: none"> • Anything that constitutes a permanent change to overall roadway horizontal and vertical clearance
Level of Access Management ¹	<ul style="list-style-type: none"> • Driveway density² • Intersection density² 	<ul style="list-style-type: none"> • Median type • Median opening spacing • Signal spacing • Intersection spacing • Frequency of pedestrian crossings • Bicycle facility design • Target speed
Freight Activity	<ul style="list-style-type: none"> • Percent and volume of heavy vehicles • Need for loading/unloading zones 	<ul style="list-style-type: none"> • Design vehicle • Lane width • Intersection curb-return radii • Bicycle facility design
Transit Activity	<ul style="list-style-type: none"> • Presence of transit routes/stops • Transit ridership • Local transit plans – Transit Development Plan, Transit Master Plan or Coordinated Plan 	<ul style="list-style-type: none"> • Lane width and use restrictions • Sidewalk and bicycle connections • Frequency of pedestrian crossings • Bicycle facility design • Transit stop location and layout
Seismic Lifeline Route / Tsunami Evacuation Route	<ul style="list-style-type: none"> • Oregon designation 	<ul style="list-style-type: none"> • Lane width • Shoulder width
Scenic Byways	<ul style="list-style-type: none"> • Oregon designation 	<ul style="list-style-type: none"> • Consideration of natural and historic resources along the corridor

¹ ODOT standards are defined and stipulated by statute OAR 734-051 and PD-03 Access Management

² Driveway density and intersection density are directly related to ODOT State Highway Designations

The Oregon Highway Plan identifies three special overlay designations for the state highway system. They include: a state highway freight network, Lifeline/Evacuation Routes (Seismic/Tsunami/Flood/Wildfire), and Scenic Byways. Designs on these designated routes have special considerations.

- **State Highway Freight System** - The primary purpose of the State Highway Freight System is to facilitate efficient and reliable interstate, intrastate, and regional truck movement through a designated freight system. This system includes routes on the National Highway System (NHS) as well as routes designated from legislative action ORS 366.215 and OAR 731, Division 12 that encompass the Reduction Review Route network.

Projects on highways that are designated as part of the Reduction Review Route network must follow the process identified in OAR 731, Division 12 to include input and support from interested parties affected by any permanent changes to the roadway. The Mobility Advisory Committee, or MAC, provides review and feedback on agency projects through the lens of freight mobility and work zone safety as it applies to both temporary and permanent reductions or restrictions on the state highway system. In addition to the Reduction Review Route highways subject to ORS 366.215 and OAR 731, Division 12, the MAC also advises the agency on planning and design of projects that propose permanent reductions or restrictions on state highways not subject to ORS 366.215 but have stakeholder engagement requirements per Department policy. Projects of this type may include safety and/or traffic calming features like roundabouts, pedestrian islands with raised features, new traffic signals, or other items that permanently change the roadway cross-section and may affect mobility of freight movements. *For state highway projects on Reduction Review Routes or projects per Department policy that have potential to permanently impact freight mobility, include the Mobility Advisory Committee (MAC) early in the design process to solicit feedback that may affect final design parameters.*

- **Lifeline/Evacuation Routes** - Earthquakes, flooding, landslides, wildfires, and other natural and man-made disasters may destroy or block key access routes to emergency facilities and create episodic demand for highway routes into and out of a stricken area. ODOT's investment strategy should recognize the critical role that some highway facilities, particularly bridges, play in emergency response and evacuation. It is the policy of the State of Oregon to provide a secure lifeline network of streets, highways, and bridges to facilitate emergency services response and to support rapid economic recovery after a disaster.
- **Scenic Byways** - While every state highway has certain scenic attributes, the Oregon Transportation Commission has designated Scenic Byways throughout the state on federal, state, and local roads which have exceptional scenic value. It is the policy of the State of Oregon to preserve and enhance designated Scenic Byways, and to consider

design elements for natural conditions and aesthetics in conjunction with safety and performance considerations on designated Byways.

Section 205 Documenting Context and Classification

This section describes how land use has been integrated into transportation planning, operations, and design in recent years. It outlines six urban land use contexts developed for state-owned roadways and provides guidance to determine the urban context of a state-owned roadway.

Although rural contexts do not have as wide of variety as the urban contexts, rural contexts and the associated cross-sectional elements need to be tied to their intended functional classification providing for a level of operation and safety. Rural contexts vary from full access-controlled interstates to rural local routes that run through populated locations.

Context and other roadway characteristics/designations must be documented early in the project development process, ideally prior to project scoping, in order to use the appropriate context-based design criteria. *Documentation becomes part of ODOT design concurrence to provide background for design decisions based on the context.*

Context is initially documented in a local agency's long-range plan and/or an ODOT facility plan. In some cases, the context may be different for the existing condition and the future planned land use. Future context must be supported by other planning and regulatory documents establishing requirements for desired future land use development in terms of zoning allowances, property dedication stipulations, building setback limitations or any other state or local development requirements that direct property redevelopment towards the future contextual goals.

If the context is documented in an existing long-range or facility plan, planners should review and coordinate with local planners to confirm the context at the start of a project. For projects that are not included in a long-range or facility plan, in collaboration with local planners, ODOT determines the context at the start of the project, prior to scoping or design. *ODOT will have the final determination of the context.*

ODOT staff determine the applicable designations and characteristics for the roadway in question (Section 204, Table 200-2 and Table 200-3). These designations/characteristics are documented through Design Documentation, including a brief description of their impact on the design. This documentation becomes part of ODOT project design documentation to provide background for design decisions based on the context, classifications, designations, and characteristics.

The urban context and roadway characteristics/designations documented at the start of the project are reviewed and updated as needed at the start of every project phase to consider current data and recent local planning efforts and become part of the overall ODOT design documentation.

205.1 Urban Context and Land Use

Oregon has been at the forefront of linking land use and transportation planning for several decades. Policy 1B in the 1999 OHP recognizes that state-owned roadways can be the main streets of many communities. The policy strives to maintain a balance between serving those main streets and the through traveler. Policy 1B sets up three categories to designate highway segments, which were later adopted into the revisions of the 2003 ODOT HDM. This was the first inclusion of separate design criteria for urban locations into the ODOT HDM. The segment designations include:

- **Special Transportation Areas (STA):** Designated districts of compact development located on a state-owned roadway within an urban growth boundary in which the need for appropriate local access outweighs the considerations of highway mobility except on designated OHP Freight Routes where through highway mobility has greater importance.
- **Urban Business Areas (UBA):** Existing areas of commercial activity or future nodes and various types of centers of commercial activity within urban growth boundaries or urban unincorporated community boundaries on District, Regional or Statewide Highways where vehicular accessibility is important to continued economic viability.
- **Commercial Centers (CC):** Large, regional centers or nodes with limited access to the state highway. Commercial Centers are to locate in a community that is the population center for the region and where the majority of the average daily trips to the center originate.

Nationally, a similar direction focusing on land use context as a driver for transportation planning and design has been taking place. “Transect” is a term from biology, where it describes the range of different habitats in nature. As with organisms who prefer to live in or thrive in different habitats, personal preferences, opportunities, constraints, and needs can determine the type of environment in which community members live or work, from a rural place to a city center, and everywhere in between. Land development patterns tend to follow a

transect as they transition from rural to urban. Within each transect zone, a predominance of specific types of land uses are expected. For instance, higher density housing and mixed-use buildings are typical in the more urban transect zones. Figure 200-1 illustrates the transect and transect zone concept.

Figure 200-1 A typical Rural to Urban Transect and Transect Zones

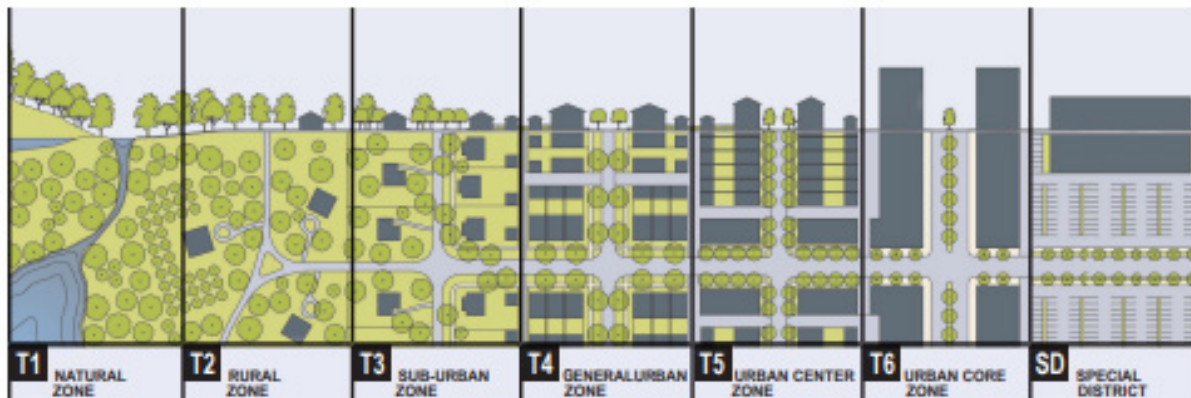

This prototypical development pattern was first established in the SmartCode in 2003 and has been evolving since. ([Center for Applied Transect Studies](#))

Since then, various agencies have adopted their own versions to help understand the users in each transect zone and the needs of roadway users in each zone. Recent efforts include the land use contexts found in the Pennsylvania and New Jersey Departments of Transportation *Smart Transportation Guidebook*; the Florida Department of Transportation's *Context Classification* system; and the National Cooperative Highway Research Program (NCHRP) Report 855: An Expanded Functional Classification System for Highways and Streets. Information from this document is included in Chapter one of the 2018 Green Book, seventh edition and will be the basis for the next update of the Green Book as the 8th edition when it is published.

NCHRP Report 855 provides a general starting point for agencies to adopt their own classification of contexts and defines the following five land use contexts:

Rural: Areas with lowest density of development, few houses or structures (widely dispersed or no residential, commercial, and industrial uses), and usually large setbacks.

Rural Town: Areas with low-density development but diverse land uses with commercial main street character, potential for on-street parking and sidewalks, and small setbacks.

Suburban: Areas with medium-density development, mixed land uses within and among structures (including mixed-use town centers, commercial corridors, and residential areas), and varied setbacks. Appropriate roadway designs require an understanding of the function of the roadway within its current and planned future contexts and the needs of the existing and potential roadway users.

Urban: Areas with high-density development, mixed land uses and prominent destinations, potential for some on-street parking and sidewalks, and buildings with varying setbacks from the roadway.

Urban Core: Areas with highest density of development, mixed land uses within and among predominately high-rise structures, and small setbacks of buildings from the roadway.

205.2 ODOT Urban Context

In developing a context-sensitive approach to planning and designing roadways in urban areas, ODOT has created a set of six urban land use contexts to describe the variety of urban areas and unincorporated communities in Oregon. As defined previously, the term “urban,” as used throughout this document, is a broad use of the word and is not limited to places within an Urban Growth Boundary (UGB), nor is it limited to the federal classification of urban being determined by a population density of 5,000 or more. Based on the Rural Community context, unincorporated cities and towns are considered as urban for the purposes of this document. However, to meet the Rural Community context there needs to be a recognition of, or semblance to, a city or town proper. Merely having a collection of houses or buildings adjacent to the highway does not fit the intended definition of a Rural Community context as it is used in this document. There needs to be a central community aspect like a post office or store in conjunction with a collection of residences to meet the intent of the Rural Community context.

The six ODOT Urban Contexts build off the NCHRP Report 855, with a few changes to reflect Oregon-specific conditions. The suburban context was split into two contexts to distinguish between commercial and residential-focused areas. The Suburban Fringe context was added to draw attention to areas transitioning from rural to a more urban context. The ODOT Urban Contexts and their relationship with the NCHRP Report 855 contexts are shown in Table 200-4.

Table 200-4 ODOT Urban Contexts in Relation to NCHRP Report 855 Contexts

ODOT Urban Context	NCHRP Report 855 Context
Traditional Downtown/ Central Business District (CBD)	Urban Core/Rural Town
Urban Mix	Urban
Commercial Corridor	Urban/Suburban
Residential Corridor	Urban/Suburban
Suburban Fringe	Suburban/Rural

ODOT Urban Context	NCHRP Report 855 Context
Rural Community	Rural Town

The six ODOT Urban Contexts shown in Table 200-4 are general and may not fit every project location specifically. Planning activities or project teams determine the appropriate context based on predominant land use, modal goals, roadway function, or other major considerations such as anticipation of future planned land use and community aspirations. Figure 200-2 illustrates the NCHRP Report 855 contexts compared to the ODOT Urban Contexts.

Figure 200-2 NCHRP Report 855 and ODOT Urban Land Uses

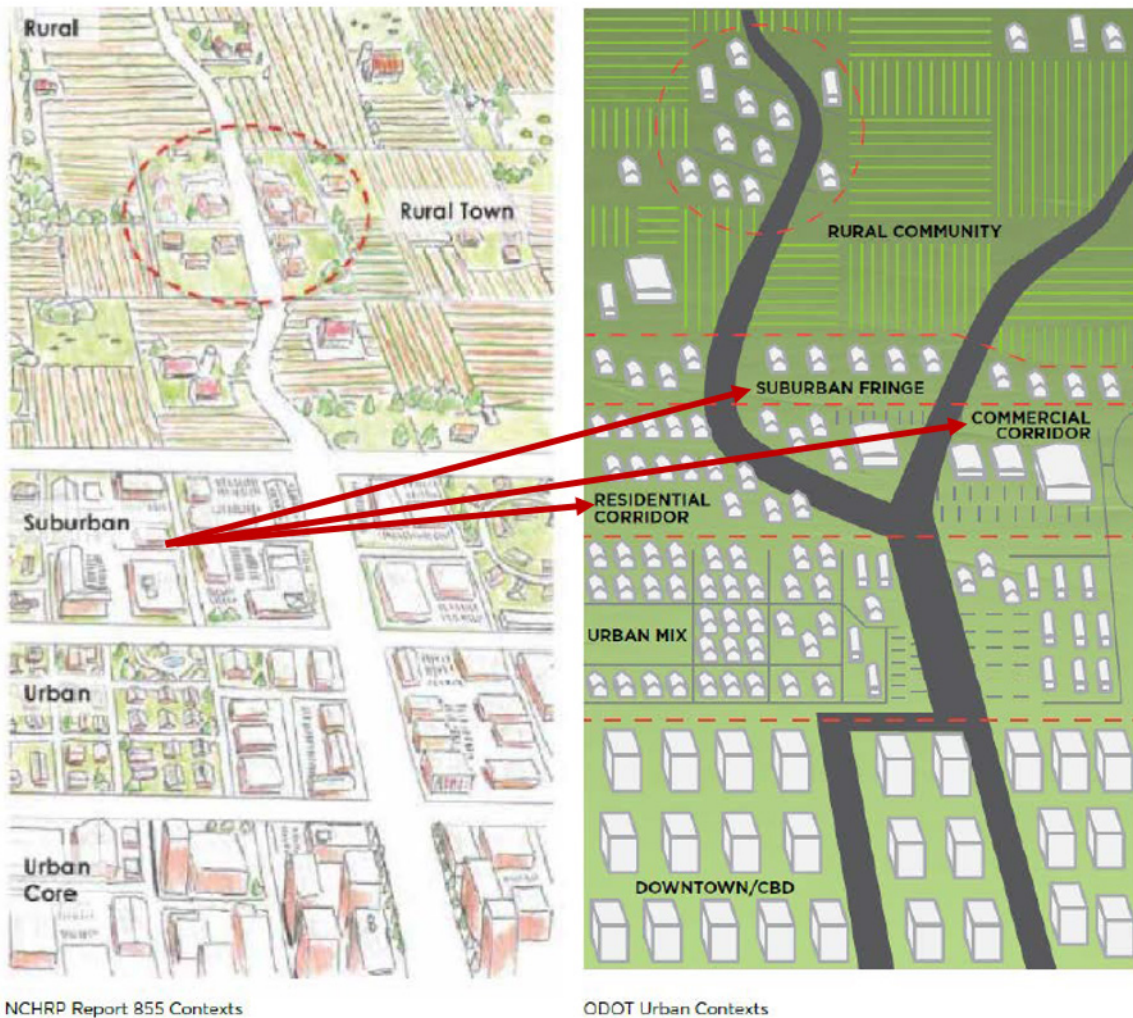

NCHRP Report 855 suggests a Suburban context. When developing the ODOT urban contexts, it was felt that a more nuanced approach to the suburban area was needed. As a result, the ODOT suburban context is separated into Commercial Corridor, Residential Corridor and Suburban Fringe contexts.

205.3 Urban Context and the Oregon Highway Plan

There is overlap between the Oregon Highway Plan Policy 1B highway segment designations of Special Transportation Area (STA), Urban Business Area (UBA), and Commercial Center (CC) and the urban contexts defined in the HDM. Figure 200-3 shows how STAs, UBAs, and CCs relate to the ODOT Urban Contexts. A Traditional Downtown/Central Business District (CBD) is generally STA like; however, a CBD is not always classified as an STA. Nor is an STA always a Traditional Downtown/CBD. An STA can be located in a Traditional Downtown/CBD, but it can also be located in an Urban Mix context or a Rural Community context. A UBA can be located within an Urban Mix context; however, Urban Mix is not always classified as a UBA. Depending on adjacent land uses and characteristics, a CC may be located in any of the urban contexts.

Figure 200-3 Oregon Highway Plan Segment Designations of Urban Contexts

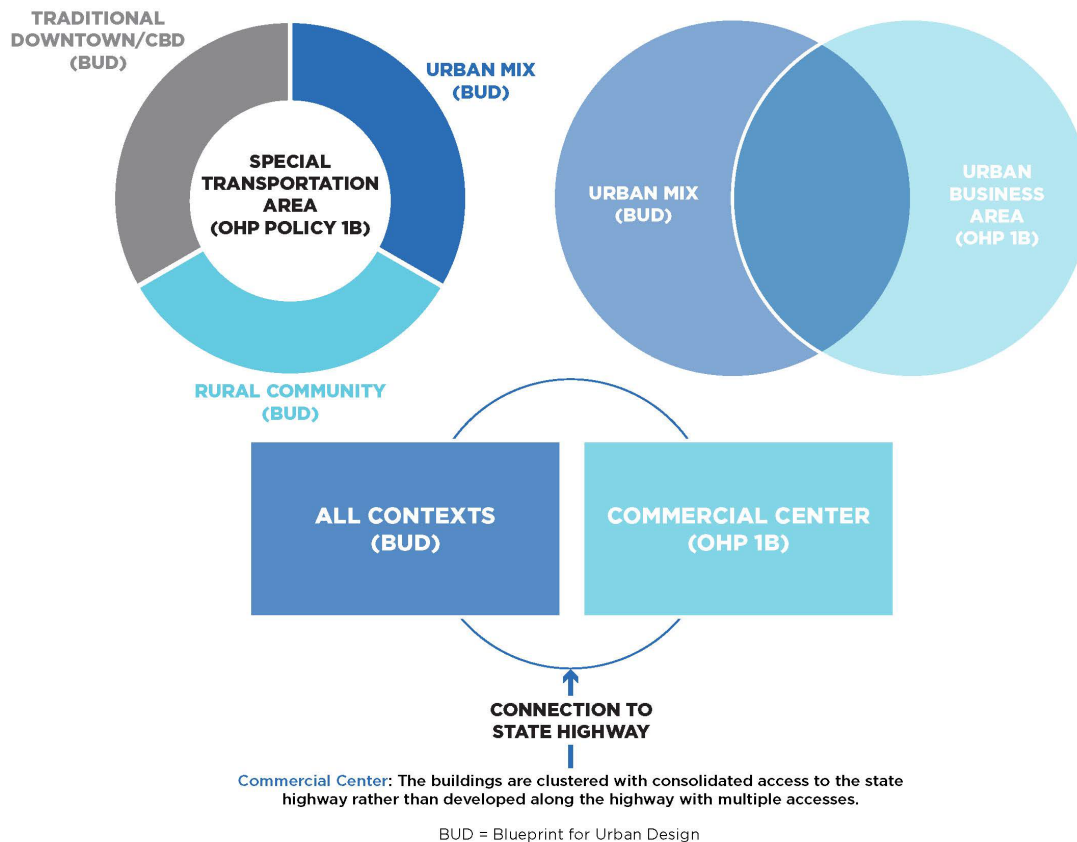

205.4 Determining Urban Context

Table 200-5 presents a framework of general characteristics to determine the urban context along state roadways. The definitions and descriptions in Section 205.2 give a broad overview of the land use types and street patterns found within each context. The measures in Table 200-5 provide more detailed assessments of the existing or planned conditions along the roadway. These measures are evaluated through a combination of field visits, internet-based aerial and street view imagery, map analysis, consultation with the local jurisdiction, and a review of land use plans including Transportation System Plans (TSP) as well as other planning studies or activities. Oregon Highway Plan segment designations are policy driven and as such, they apply to all context evaluations. While they are not specific to any single urban context, segment designations assigned to a roadway section do play a part in the final design criteria of a determined urban context. The OHP segment designations are part of the final evaluation as needed, but the urban context is not solely dependent on a highway segment designation. For example, an ODOT roadway does not need to be designated as an STA to be considered a Traditional Downtown/CBD context; however, if a roadway section is determined to be an Urban Mix and it is also designated as an STA, then the final design needs to include appropriate STA criteria.

Projects with a relatively short design horizon, such as resurfacing projects, may only need to consider existing conditions in the determination of the urban context. However, it is beneficial for practitioners to look for opportunities to support future land use expectations identified in planning activities and address gaps in the bicycle and pedestrian network, where feasible.

Proposed developments with approved permits are considered part of the existing conditions. For projects with a longer design life that consider future transportation demand projections, documented future land use plans are considered in determining the urban context.

In some cases, the urban context may differ on each side of the roadway (e.g., commercial corridor across from residential corridor). Where characteristics differ on each side of the roadway, appropriate context determination is focused on predominant land use, modal balance/needs, roadway function, or other major considerations. Generally, there is enough flexibility within the design matrices for the determined context to provide a consistent cross-section when contexts overlap.

Table 200-5 ODOT Urban Context Matrix

Land Use Context	Building Setbacks Distance from the building to the property line	Building Orientation Buildings with front doors that can be accessed from the sidewalks along a pedestrian path	Land Use Existing or future mix of land uses	Building Coverage Percent of area adjacent to right-of-way with buildings, as opposed to parking, landscape, or other uses	Parking Location of parking in relation to the buildings along the right-of-way	Block Size Average size of blocks adjacent to the right-of-way
Traditional Downtown/ CBD	Shallow/ None	Yes	Mixed (Residential, Commercial, Park/Recreation)	High	On-street/ garage/ shared in back	Small, consistent block structure
Urban Mix	Shallow	Some	Commercial fronting, residential behind or above	Medium	Mostly off-street/Single row in front/ In back/ On side	Small to medium blocks
Commercial Corridor	Medium to Large	Sparse	Commercial, Institutional, Industrial	Low	Off-street/In front	Large blocks, not well defined
Residential Corridor	Shallow	Some	Residential	Medium	Varies	Small to medium blocks
Suburban Fringe	Varies	Varies	Varied, interspersed development	Low	Varies	Large blocks, not well defined
Rural Community	Shallow/ None	Some	Mixed (Residential, Commercial, Institutional, Park/Recreation)	Medium	Single row in front/ In back/ On side	Small to medium blocks

205.5 Urban Context and Multimodal Users

The ODOT Urban Contexts can also help planners and engineers understand the types of users and the intensity of use expected within each urban context. For example, in a Traditional Downtown/CBD, practitioners would expect a higher number of pedestrians, bicyclists, and transit users than in a Suburban Fringe context. Therefore, slower speeds, shorter signal spacing, shorter crossing distances, and other design elements such as bicycle facilities, on-street parking, and wide sidewalks are considered as strategies to improve safety and comfort of the anticipated users (bicyclists, pedestrians, and transit riders). However, freight movements and delivery of goods to business within a Traditional Downtown/CBD must also be accommodated.

In a Suburban Fringe area, designers would expect a predominance of vehicles and freight; however, bicyclists and pedestrians are also likely to be present and enhanced facilities are considered for safety and comfort. A roadway in the Suburban Fringe context would typically have higher speeds, and lower levels of traffic delay, but the design elements for the facility will change as it transitions into different urban contexts.

When determining the roadway typical section proposed for a project, designers use the urban context to better understand the anticipated users and identify appropriate consideration for each of them. Table 200-6 shows a representation of the relative need of each user type to drive planning and design decisions in the different urban contexts. This table is a starting point and not a final determination of modal considerations. Specific modal integration is determined on a project-by-project basis; however, modes with lower consideration must still be accommodated. For example, there will be freight needs to deliver products to businesses in a CBD. Even if freight is a lower consideration compared to bicyclists and pedestrians, project-level needs incorporate how freight will access the area. In this example, it may mean the design vehicle is a single-unit (SU) and a tractor-trailer combination WB-67 is “accommodated”. However, on Reduction Review Routes, ORS 366.215 and OAR 731-012 requirements must also be considered in these decisions. The following parts and sections will contain more guidance on criteria to be used for each urban context. Guidance for bicycle facility selection and its relation to modal integration is located in Part 900, Bikeway Design.

Table 200-6 General Modal Considerations in Different Urban Contexts

Land Use Context	Motorist	Freight	Transit	Bicyclist	Pedestrian
Traditional Downtown/CBD	Low	Low	High	High	High
Urban Mix	Medium	Low	High	High	High
Commercial Corridor	High	High	High	Medium	Medium
Residential Corridor	Medium	Medium	Low	Medium	Medium
Suburban Fringe	High	High	Varies	Low	Low
Rural Community	Medium	Medium	Varies	High	High

High: Highest level facility should be considered and prioritized with other modal treatments.

Medium: Design elements should be considered; trade-offs may exist based on desired outcomes and user needs.

Low: Incorporate design elements as space permits.

Section 206 Examples of ODOT Urban Contexts

206.1 Traditional Downtown/Central Business District

Thinking of the Traditional Downtown/Central Business District context, the major sections of downtown Portland, Salem, Eugene, Bend, Medford or Grants Pass come to mind. However, smaller towns and cities like Tillamook, Astoria, Coos Bay, Bandon, Hood River, Baker City, Lakeview and Burns, to name a few, also have great downtown areas and are considered in the Traditional Downtown/Central Business District context. Small block sizes characteristic to the Traditional Downtown/Central Business District encourage walking, biking and transit modes for access to properties, business and activities.

General Characteristics of the Traditional Downtown/Central Business District context:

Buildings are generally at the back of walk or with small setbacks. Access to buildings is from the sidewalk or pedestrian pathway. Land use is mostly commercial and retail with some mixed residential, park space or small recreation areas. Buildings cover large portions of properties adjacent to the highway and block sizes are small with on-street parking or shared parking in back of buildings along with a developed grid system of streets. Figure 200-4 and Figure 200-5 illustrate the Traditional Downtown/Central Business District context.

Figure 200-4 Aerial - Baker City, Downtown Grid (US30/OR7)

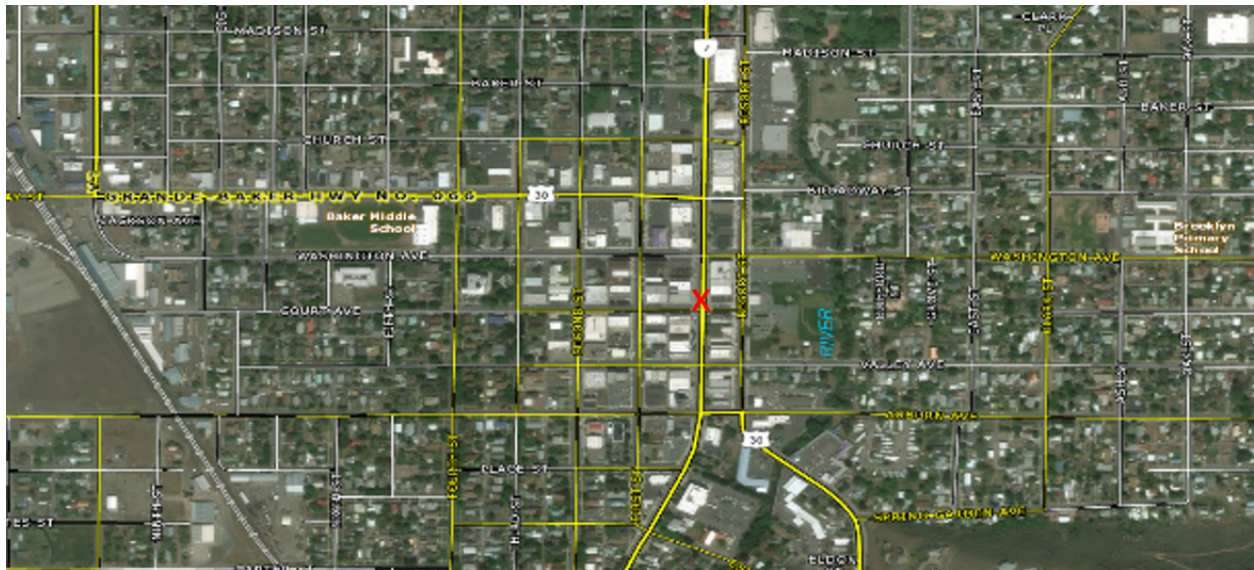
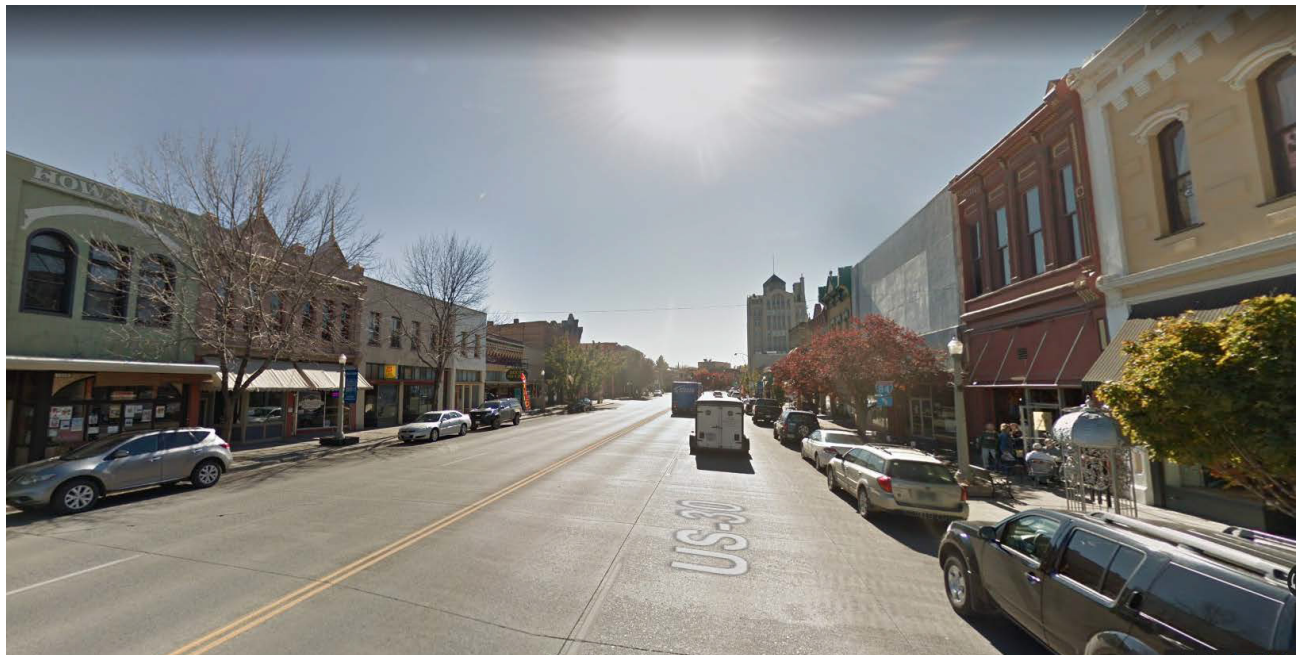

Figure 200-5 Baker City Downtown (US30)



206.2 Urban Mix

The Urban Mix context generally is the area adjacent as a roadway moves outward from the central downtown area. It is often established as businesses move outward into older residential areas and properties redevelop or repurpose. There may be no defining line between a Traditional Downtown/Central Business District and an Urban Mix. The two contexts may morph into one another. Smaller block sizes are conducive to walking, biking and transit for access to properties.

General Characteristics of the Urban Mix Context: Building setbacks are generally shallow with a mix of buildings tight with the sidewalk and some with a small frontage to the sidewalk and pedestrian pathway. Land use is commercial, retail or professional offices fronting the property and may have residential on upper floors or in back. In conjunction with the business properties, there may be older residential mixed in with the more recent property redevelopments. Building coverage is generally medium in relation to property sizes with some on-street parking, but parking is mainly off-street, single row parking in front, in back or on side. The street network is in a connected grid pattern with blocks small to medium in size. Figure 200-6 and Figure 200-7 illustrate the Urban Mix context.

Figure 200-6 Aerial - Urban Mix Portland: US26, Powell Blvd. West of I-205 (Inner Powell)

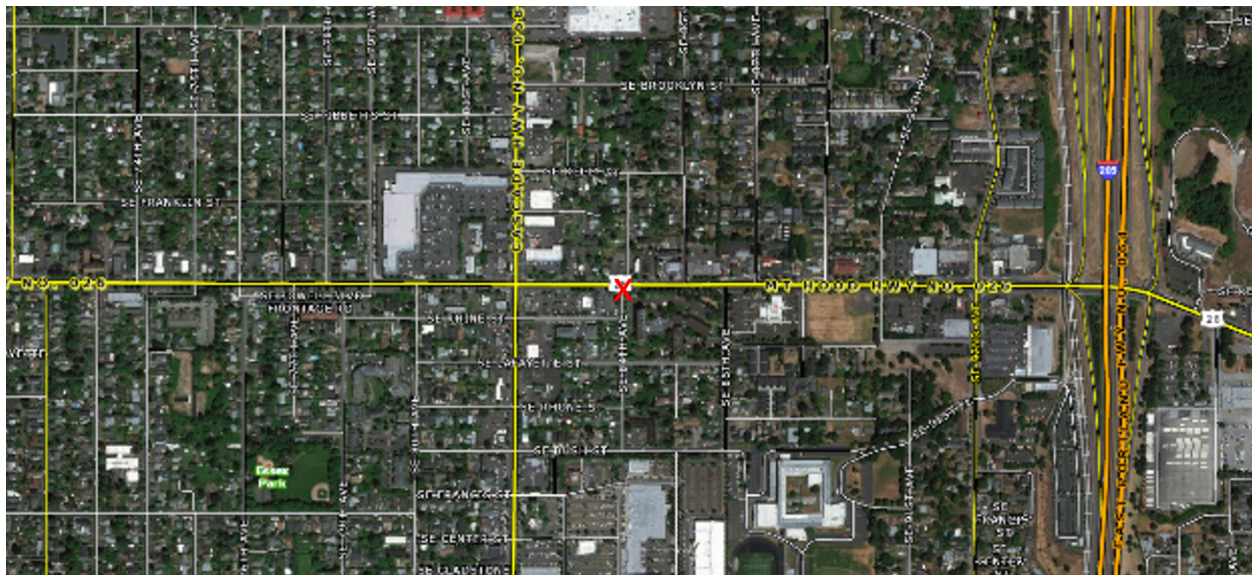

Figure 200-7 Urban Mix - Portland US26, Powell Blvd.



206.3 Commercial Corridor

A Commercial Corridor context is readily identifiable and consists primarily of large commercial, retail or industrial properties along major, higher speed arterials. As a result, access to properties along a Commercial Corridor has traditionally been focused on motorized vehicles with some transit access. A connected street network grid is not usually present as many of the properties in this context developed on large tracts of land that were originally at the edge of communities and subsequent characteristic development followed as the rest of the corridor was established. Special attention is needed when designing bicycle and pedestrian facilities for this context.

General Characteristics of the Commercial Corridor Context: Building setbacks are medium to large with off-street parking area between the sidewalk and building entrances. Building coverage on the properties is small in relation to the total right-of-way. Land uses encompass commercial, retail or industrial businesses that include large parking areas for customers and employees. Figure 200-8 and Figure 200-9 illustrate the Commercial Corridor context.

Figure 200-8 Aerial - Commercial Corridor, US97 South Redmond



Figure 200-9 Commercial Corridor - US97 South Redmond



206.4 Residential Corridor

The Residential Corridor context differs from the Commercial Corridor with its higher density of residential properties. It may be along a higher speed arterial as is a Commercial Corridor, but greater potential for pedestrian, bicycle and transit access from residential properties will be a design focus along Residential Corridors. This context has a more connected street grid network and may have mixed commercial, retail and light industrial activities to support the

Figure 200-11 Residential Corridor - OR 221, West Salem (Parkway Concept)



206.5 Suburban Fringe

The Suburban Fringe context is generally the transition area from higher speed rural roadways to the lower speed urban section entering communities. The design focus for this context is speed control and communicating to drivers they are entering an urban area or rural community.

General Characteristics of the Suburban Fringe Context: Building setbacks vary with no specific distance but are generally large. Few buildings are at the roadway or right-of-way edge. Properties are generally larger with buildings taking up minimal space leaving large open areas. Land use is varied. Development is interspersed with residential, farming, commercial, retail and industrial. Block sizes are large and not well defined. Parking is primarily off-street, although depending on the adjacent urban context, some on-street parking could be present. Figure 200-12 and Figure 200-13 illustrate the Suburban Fringe context.

Figure 200-12 Aerial - Suburban Fringe, OR 212 Damascus

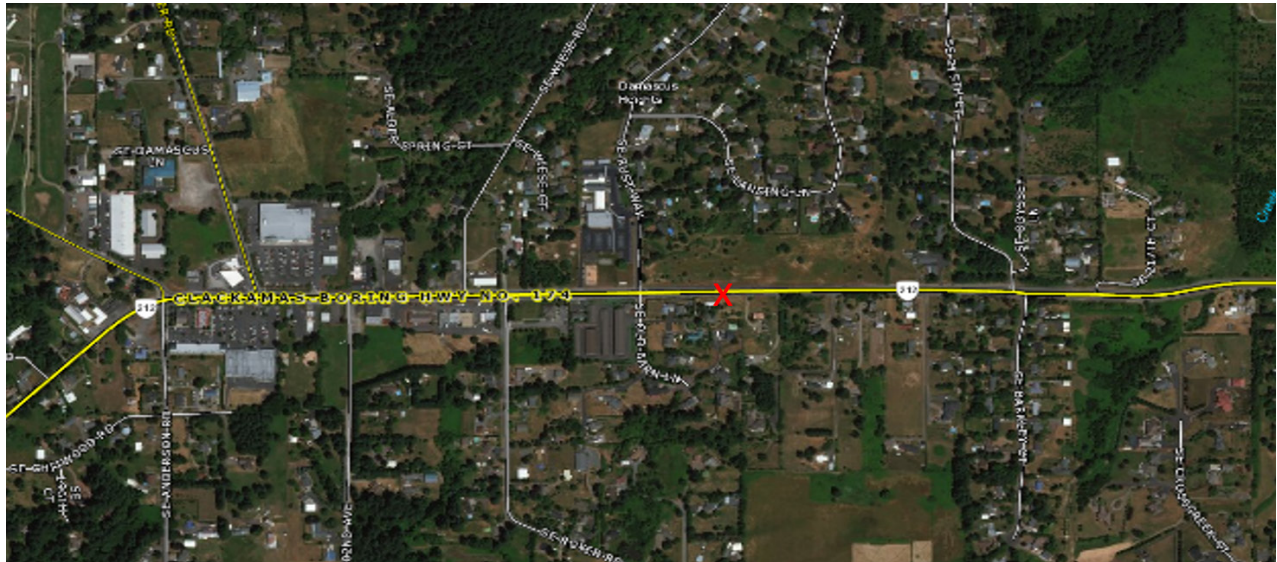

Figure 200-13 Suburban Fringe - OR 212 Damascus



206.6 Rural Community

The Rural Community context was established for small, unincorporated communities that encompass concentrated areas of development surrounded by undeveloped areas with the highway running through main street. The design focus in this context is on speed control and connectivity. Safe access across the highway for residents of these communities is paramount

for community activities. Students getting to school, people accessing mail at the post office or shopping for groceries are daily activities that can be done through walking and biking for many residents, rather than driving short distances. Providing designs that control the speed of through traffic and provides facilities to enhance safe walking and biking can improve the quality of life for these communities. It is important to strike a balance between through traffic needs and local community needs.

General Characteristics of the Rural Community Context: Building Setbacks are shallow to none with open frontages and a single row of parking along the edge of the highway. Land use is varied with some residential mixed with mostly small businesses, small retail or light industrial. Post offices, general stores, parks and recreation facilities are common. Block size is generally small and often not well defined. Figure 200-14 and Figure 200-15 illustrate the Rural Community context.

Figure 200-14 Aerial - Rural Community, OR 22 Gates

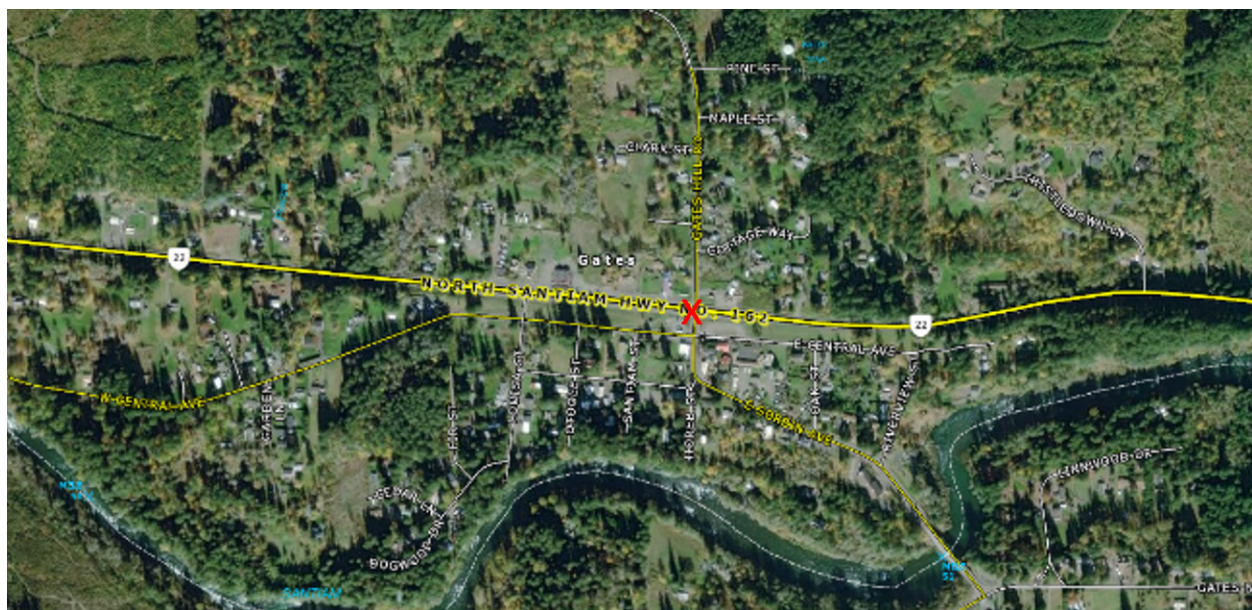

Figure 200-15 Rural Community, OR 22 Gates



Section 207 Designing Based on Context and Classification

The purpose of this section is to outline how the contexts, modal expectations, and roadway characteristics described earlier in this part can be applied together, with the design approach described for each context. The following sub-sections and Table 200-7 provide general guidance on design direction for various elements of the roadway design. More specific guidance for design elements within each land use context is included in Part 300. The design guidance tables and cross section figures in Part 300 also provide more detail on considering different roadway characteristics.

207.1 Urban and Rural Freeways (Including Interstates)

Speeds for these roadways range from 50 to 70 mph. These access-controlled facilities focus on the vehicular mode, mobility over access, and need to accommodate the heavy and large loads that use urban and rural freeways, including the interstate system. Both the urban and rural freeway contexts have similar modal expectations and roadway contexts, although the urban freeways traverse through the different urban environments.

207.2 Urban and Rural Expressways

Similar to urban and rural freeways, urban and rural expressways mainly focus on vehicle mobility, although expressways may not have similar levels of access control as freeways.

Because expressways may consist of grade separated or at-grade intersections, the level of modal accommodation will vary. Speeds are relatively high ranging from 45 to 70 mph depending on urban or rural environments. Urban expressways with grade separated accesses do not fit the six urban contexts defined in the HDM and are generally designed using Urban freeway criteria. However, urban expressways with at-grade intersections do fit with the six ODOT urban contexts and are subject to the appropriate design criteria for the selected context.

As with any urban roadway, right of way, cost, terrain, and other constraints may necessitate designing expressways below the standards described for them. The appropriate design exception must be obtained to reduce any design element below standard criteria. Justification for exceptions from expressway design standards must be substantial. Due to the mobility needs of expressways, they are held to a high standard and therefore exceptions should be minimized. For more information on the design exception process, refer to Part 1000.

207.3 Rural Arterials, Collectors, and Local Routes

Rural arterials, collectors, and local routes serve most uses related to vehicular traffic moving through rural arterials, but also a wide range of modes due to the rural arterial functional classification making up a large percentage of rural facilities ranging from rural arterials to rural local routes. Speed ranges also vary in the range of 45 to 70 mph.

207.4 Traditional Downtown/Central Business District

To best serve all users, vehicle speeds are generally 25 mph or below, and higher levels of congestion are expected. Transit stops are placed at frequent intervals, and transit priority treatments can help with transit mobility, even in congested conditions. Preferred bicycle and pedestrian facilities are relatively wide and comfortable to serve users of all ages and abilities. Curbside uses are important and may include transit and freight loading/unloading needs, parking (vehicles, bicycles, etc.), and other uses. Landscaping and street tree installation follows ODOT placement and spacing guidelines and are appropriate in this context.

207.5 Urban Mix

To best serve all users, vehicle speeds are typically 25 to 30 mph, and higher levels of congestion are acceptable. Transit stops are placed in proximity to origins and destinations. Preferred bicycle and pedestrian facilities are relatively wide and comfortable to serve users of all ages and abilities. Where low speeds cannot be achieved, practitioners must consider a buffer between travel lanes and bicycle and pedestrian facilities. Curbside uses are important and may include transit and freight loading/unloading, parking (vehicles, bicycles, etc.), and other uses.

Landscaping and street trees, following ODOT placement and spacing guidelines, are appropriate in this context.

207.6 Commercial Corridor

Multimodal access to destinations must be balanced with vehicle and freight throughput. Vehicle speeds are typically 30 to 35 mph, depending on the roadway function. Medians facilitate access to commercial destinations. Demand for transit service is moderate to high due to the prevalence of commercial land use. Bicycle and pedestrian connections to transit are emphasized as part of the bicycle network. Boarding and alighting occur at the curbside. Preferred bicycle and pedestrian facilities are separated from travel lanes by a buffer.

207.7 Residential Corridor

On state-owned roadways, these streets are likely to see use from a variety of modes, with most uses related to vehicular traffic moving through the area. Vehicle speeds are typically 30 to 35 mph, depending on the roadway function. The single-use nature of this context limits the multimodal activity; however, providing bicycle and pedestrian facilities is preferred for residents. Facilities separated from travel lanes by a buffer are preferred. Consider local pedestrian/bicycle plans when designing for the Residential Corridor context. Providing appropriate enhanced crossings where desired by local communities can benefit pedestrian movement along and across the highway.

207.8 Suburban Fringe

Pay special attention to the expected future context of the roadway when determining the level of consideration paid to each mode. Speeds will generally be higher on these roadways with a range of 35 to 40 mph. Therefore, evaluate bicycle and pedestrian facilities to meet existing and future needs. Although not always possible, facilities separated from travel lanes by a buffer provide safer and more comfortable experiences for users and are the preferred choice. This context often separates rural areas from more urban contexts. A primary goal of projects in this context is to lower operating speeds through appropriate transition zones as vehicles enter more urbanized areas.

207.9 Rural Community

In this context, streets are likely to see use from a variety of modes, with most uses related to either vehicular traffic moving through the town or local community members moving throughout the community via walking, bicycling, or driving. To best serve this mix of users, encourage vehicle speeds in the range of 25 to 35 mph entering the town, potentially through the use of speed transition zones. Other design features can help inform drivers they are entering a town, such as “gateway” intersections, street trees lining the street, or other local icons/art/signs visible from the street. Pedestrian crossings of the roadway in rural towns are relatively frequent to reduce the roadway’s impact as a barrier. Designs related to sidewalks, bicycle facilities, and curbside uses reflect the need of the local community.

Table 200-7 Designing Based on Context, Considering Roadway Designations and Activity of Different Modes

Context	Typical Speed Ranges (MPH) ⁴	Travel Lanes ^{1,2}	Turn Lanes ^{1,2}	Shy Distance ^{1,3}	Median ^{1,2}	Bicycle Facility ^{1,2,5}	Sidewalk	Target Pedestrian Crossing Spacing Range (feet) ⁶	On-street parking ¹
Urban and Rural Freeways (including interstates)	50-70 mph	Start with standard	Not Applicable	Start with standard	Start with standard	Generally, Not Applicable (only in specific cases)	Not Applicable	Not Applicable	Not Applicable
Grade Separated Urban and Rural Expressways	45-70 mph	Start with standard	Not Applicable for Grade Separations/ Start with standard	Not Applicable for Grade Separations/ Start with standard	Start with standard	Generally, Not Applicable (only in specific cases)	Not Applicable	Not Applicable	Not Applicable
At-Grade Urban and Rural Expressways	45-70 mph	Urban - Use Context Rural - Start with Standard	Urban - Use Context Rural - Start with Standard	Urban - Use Context Rural - Start with Standard	Urban - Use Context Rural - Start with Standard	Urban - Use Context Rural - Start with Standard See Part 900	Urban - Use Context Rural - Start with Standard See Part 800, 900	Urban - Use Context Rural - Start with Standard	Urban - Use Context Rural - Start with Standard

Table 200-7 (Continued): Designing Based on Context, Considering Roadway Designations and Activity of Different Modes

Context	Typical Speed Ranges (MPH) ⁴	Travel Lanes ^{1,2}	Turn Lanes ^{1,2}	Shy Distance ^{1,3}	Median ^{1,2}	Bicycle Facility ^{1,2,5}	Sidewalk	Target Pedestrian Crossing Spacing Range (feet) ⁶	On-street parking ¹
Rural Arterials/ Collectors/ Local Route	45-70 mph	Start with standard	Start with standard	When applicable, Start with standard	Start with standard	Start with standard	When applicable, Start with standard	When applicable, Start with standard	When applicable, start with standard
Traditional Downtown / CBD	20-25	Evaluate, start with preferred widths, wider by roadway characteristics	Minimize additional crossing width at intersections	Minimal	Optional, use as pedestrian crossing refuge	Start with separated bicycle facility	Ample space for sidewalk activity (e.g., sidewalk cafes, transit shelters)	250-550 (1-2 blocks)	Include on-street parking if possible
Urban Mix	25-30	Evaluate, start with preferred widths, wider by roadway characteristics	Minimize additional crossing width at intersections	Minimal	Optional, use as pedestrian crossing refuge	Start with separated bicycle facility, consider roadway characteristics	Ample space for sidewalk activity (e.g., sidewalk cafes, transit shelters)	250-550 (1-2 blocks)	Consider on-street parking if space allows

Table 200-7 (Continued): Designing Based on Context, Considering Roadway Designations and Activity of Different Modes

Context	Typical Speed Ranges (MPH) ⁴	Travel Lanes ^{1,2}	Turn Lanes ^{1,2}	Shy Distance ^{1,3}	Median ^{1,2}	Bicycle Facility ^{1,2,5}	Sidewalk	Target Pedestrian Crossing Spacing Range (feet) ⁶	On-street parking ¹
Commercial Corridor	30-35	Evaluate, start with preferred widths, wider by roadway characteristics	Balance crossing width and operations depending on desired use	Consider roadway characteristics, desired speeds	Typically used for safety/operational management	Start with separated bicycle facility, consider roadway characteristics	Continuous and buffered sidewalks, with space for transit stations	500-1,000	Not Applicable
Residential Corridor	30-35	Evaluate, start with preferred widths, wider by roadway characteristics	Balance crossing width and operations depending on desired use	Consider roadway characteristics, desired speeds	Optional, use as pedestrian crossing refuge	Start with separated bicycle facility, consider roadway characteristics	Continuous and buffered sidewalks	500-1,000	Generally Not Applicable, Consider roadway character
Suburban Fringe	35-40	Evaluate, start with preferred widths, wider by roadway characteristics	Balance crossing width and operations depending on desired use	Consider roadway characteristics, desired speeds	Optional, use as pedestrian crossing refuge	Start with separated bicycle facility, consider roadway characteristics	Continuous and buffered sidewalks	750-1,500	Not typical

Table 200-7 (Continued): Designing Based on Context, Considering Roadway Designations and Activity of Different Modes

Context	Typical Speed Ranges (MPH) ⁴	Travel Lanes ^{1,2}	Turn Lanes ^{1,2}	Shy Distance ^{1,3}	Median ^{1,2}	Bicycle Facility ^{1,2,5}	Sidewalk	Target Pedestrian Crossing Spacing Range (feet) ⁶	On-street parking ¹
Rural Community	25 - 35	Evaluate, start with preferred widths, wider by roadway characteristics	Balance crossing width and operations depending on desired use	Consider roadway characteristics, desired speeds	Optional, use as pedestrian crossing refuge	Start with separated bicycle facility, consider roadway characteristics	Continuous and buffered sidewalks, sized for desired use	250-750	Consider on-street parking if space allows

¹ Design decisions consider the presence and volumes of freight and transit activity. Follow the Reduction Review Route policy and process.

² Design decisions must consider the existing level of access management and/or the driveway density.

³ Shy distance: the lateral distance from the edge of the travel way beyond which a roadside object will not be perceived as an immediate hazard by the typical driver.

⁴ Section 207.10, (Target Speed) provides the approach and strategies associated with target speed.

⁵ Section 306 and Part 900 provide guidance to determine appropriate bicycle facility selection.

⁶ Section 307 and Part 800 provide guidance for pedestrian crossing locations and pedestrian facilities.

207.10 Speed, Context, and Design

207.10.1 Design Speed

Design speed is a selected speed used to determine the various geometric design features of the roadway. The selected design speed is consistent with the speeds that drivers are likely to expect on a given highway. The design speed of a project may have a direct impact on the cost, safety, and quality of the finished project. With the exception of local streets, the chosen design speed in rural areas should be as high as practicable to attain a specified degree of safety, mobility, and efficiency while taking into consideration constraints of environmental quality, social and political impacts, economics, and aesthetics. In urban situations, the design speed is generally equal to or, where necessary, higher than the posted speed of the particular section of roadway. When establishing a project design speed, consider land use, pedestrian needs, safety, and community livability. Care must be taken to not confuse design speed with operating speed, posted speed, 85th percentile speed, target speed, or running speed. See AASHTO's "Geometric Design of Highways and Streets - 2018" for a detailed explanation of each of these different kinds of speeds.

The selection of a design speed for any given project is dependent on several factors. These factors include traffic volume, geographic characteristics of an area, functional classification of the roadway, number of travel lanes, 50th and 85th percentile speeds, roadway environment, adjacent land use, context, and type of project being designed. Design speeds are generally selected in increments of 5 mph.

When selecting an appropriate design speed, the roadway section in question as well as adjacent sections to the proposed project are considered. Within the project, the chosen design speed is applied consistently throughout the section keeping in mind the speed a driver is likely to expect. This is very important when dealing with horizontal and vertical alignments, superelevation rates, and spiral lengths. For example, a project with a selected design speed of 55 mph may consist of multiple horizontal curves. All horizontal curves should be designed for 55 mph along with the appropriate superelevation and spiral length for the design speed. Some projects may cross over different contexts. In these instances, more than one design speed may be appropriate for the project. The proper use of design speed creates consistent roadways and expectations for the driver. Due to economical or environmental reasons all curves may not be able to achieve the desired design speed. In those cases, it is important that the driver be advised of the lower speed condition ahead with the use of curve warning signs.

Finally, selecting the appropriate design speed for a particular section must consider transition areas from rural to urban environments. Providing a smooth and clear transition from high rural speed conditions to urban environments is critical in controlling drivers' perceptions of

the areas they are entering. These transitions alert users of the changing environment, and control vehicular speeds as they enter various urban environments. The most common and effective transitions are those that establish a different roadway culture such as sidewalks, buffer strips, and raised medians. Another common technique for transition areas is visual narrowing of the roadway. This can be accomplished with raised islands, buffer strips, and landscaping.

Although this section will primarily focus on design speed for motor vehicles, the design speed selection process is also considered for other modes such as bicycles. Design speed guidance for bicycle facilities is located in Part 900.

207.10.2 Selecting Project Design Speed

For all projects on state highways, the design speed is selected by the Region Roadway Manager and the Region Traffic Manager in cooperation with Technical Services Roadway Staff. This applies to private developments only if they include any construction on the highway, other than the access itself. *Where mitigation impacts the cross-section or alignment of the highway, such as a channelization, widening or striping, the design speed must be approved by the Region Roadway Manager before any permit is issued.*

Design speed is integral to many other design elements. As such, selection of design speed needs to be carefully considered to determine an appropriate value. For urban locations, it may be appropriate to utilize the posted speed as project design speed. For higher speed interstate highways, freeways and other roadways in open road locations, it may be advantageous to select a design speed higher than the posted speed to allow for driver variability. The selected design speed for non-freeway 3R and Single Function projects is the same as the posted speed in most cases and does not require an approval. However, there may be occasions where the Region's goals for a section of roadway would call for selecting a design speed that is higher than the posted speed. **Under no circumstances will a design speed be lower than the posted speed and in general, design exceptions are not granted for design speed.** Rather, selection of an appropriate design speed is preferred.

Additional information on specific design speeds and target speeds based on specific cross sectional information and context can be found in PART 300- Cross Section Elements.

207.10.3 Target Speed

Target Speed is a term and concept developed in the 2010 Institute of Transportation Engineers (ITE) publication, *Designing Walkable Urban Thoroughfares: A Context Sensitive Approach* and is used primarily in urban locations. ITE defined target speed as the highest operating speed at which vehicles should ideally operate on a roadway in a specific context. AASHTO has

a working definition of target speed that defines it as the operating speed that the designer intends for drivers to use. For ODOT purposes, target speed is the appropriate speed at which drivers should be operating a vehicle on a section of roadway based on context, classification and overall operations. Target speed differs from design speed in that it is often an aspirational goal of a project and may be the ultimate goal for speed reduction along a roadway segment. *Design speed for a project can be set at the posted speed limit, but it is not set below the posted speed limit. Depending on context, roadway operations and characteristics, target speed may be established below the posted speed limit when appropriate speed reduction is a project goal.* Target speeds need to be determined with realistic goals in mind. Target speed needs to fit with the context and operational needs of a location. Setting a target speed 15 mph below the posted speed on a major, urban arterial in a Commercial Corridor context may not be realistic when considering the design element options available to achieve that much of a speed reduction. *Other than a roundabout, no single design treatment will afford significant speed reduction. Research has shown speed reductions of 5 mph and sometimes as high as 10 mph can be achieved when combinations of design treatments are utilized together.*

Reducing vehicle operating speeds on highways within urban areas can encourage walking and bicycling and reduce fatal and serious injury crashes. *Considering the target speed (desired operating speed) and identifying strategies to achieve the desired speed are key priorities for urban projects.* Understanding the relationship between the target speed, design speed, and posted speed can help practitioners consider the trade-offs from a speed perspective and how speed may influence the characteristic of the roadway and its users.

207.10.4 Recommendations for Target Speed

A goal in urban locations, is for the target speed, the posted speed and design speed to be the same, and a roadway should encourage an actual operating speed at the target speed. This is a concept that has become known as a “self-enforcing roadway”. However, rarely is this the case at project scoping or project initiation and lowering operating speeds to aspirational target speeds then becomes a project goal. Ideally, the target speed is intended to be used as the posted speed limit in urban locations after projects are complete. When the target speed is less than the posted speed limit and/or the design speed, project design provides appropriate speed management treatments to encourage drivers to operate at the intended target speed. If the design treatments are successful in lowering operating speeds to the target speed, then the posted speed can also be lowered to match the target and operating speeds. Table 200-8 provides recommendations for target speed in each ODOT defined urban context. It also includes a list of suggested design treatments to incorporate in project designs to aid in achieving the desired target speed.

Table 200-8 Recommended ODOT Target Speed and Design Treatments for Urban Contexts

Urban Context	Target Speed (MPH)	Design Treatments
Traditional Downtown/CBD	20-25	Roundabouts, lane narrowing, speed feedback signs, on-street parking ¹ , street trees ² , median islands, curb extensions, chicanes ³ , textured surface, coordinated signal timing, speed tables ³ , road diets
Urban Mix	25-30	Roundabouts, lane narrowing, speed feedback signs, on-street parking ¹ , street trees ² , median islands, curb extensions, chicanes ³ , textured surface, coordinated signal timing, road diets
Commercial Corridor	30-35	Roundabout, lane narrowing, speed feedback signs, landscaped median Islands, coordinated signal timing, road diets
Residential Corridor	30-35	Roundabout, lane narrowing, speed feedback signs, landscaped median Islands, coordinated signal timing, road diets
Suburban Fringe*	35-40	Roundabouts, transverse pavement markings, lane narrowing, speed feedback signs, road diets, entry treatments
Rural Community	25-35	Roundabouts, lane narrowing, speed feedback signs, on-street parking ¹ , street trees ² , median islands, curb extensions, chicanes ³ , speed tables ³ , road diets, entry treatment

* The suburban fringe context is typically suburban adjacent to rural areas at the edge of urban development, but often is in the process of developing. For projects in the suburban fringe context zone, practitioners should consider likely future development and consider applying designs for residential corridor, commercial corridor, or urban mix contexts if this type of development is likely to occur.

¹ If on-street parking is not well utilized, the additional pavement width may increase operating speeds.

² When used along roadways, street trees may not reduce speeds in a specific urban context to a point where it is appropriate to have a vertical element adjacent to the roadway.

³ Speed tables and chicanes may not be appropriate on most state roadways but may be considered in special cases.

207.11 Posted Speed

Posted speed is the legally enforceable maximum speed drivers must follow. In Oregon, posted speed limits are set based on a number of factors, including the results of a speed study. Many factors are considered when making a recommendation for an appropriate posted speed. The

speed data and crash history play an integral part in determining a recommended speed. The posted speed is heavily influenced by the existing conditions, including roadway geometry, the roadside culture and development, and Oregon statutes.

As with most state transportation departments, ODOT's traditional approach for setting speed has depended on the 85th percentile speed as the key factor in determining the recommended speed. The 85th percentile speed is still used for rural higher speed locations. However, more recent research has developed better strategies for determining posted speeds for urban locations.

This is a general discussion about setting posted speeds. *For more detailed and current information on how posted speeds are set for urban locations, consult the ODOT Speed Zone Manual.*

207.12 85th Percentile Speed

The 85th percentile speed is that speed at or below which 85 percent of the drivers operate their vehicles. The posted speed and the 85th percentile speed may not always be the same. In some instances, where statutory speeds have been applied or in urban areas, the posted speed may be set below the 85th percentile speed. All non-statutory posted speeds are determined by a speed study. The designer should check with the Technical Services Traffic-Roadway Section for speed study information when using 85th percentile and posted speeds in design. Measuring operating speeds in the field can provide additional information for consideration in selecting the appropriate design and target speeds and is strongly recommended.

Section 208 Urban Arterial Design

This section provides guidance for general design and standard selection for urban arterials. Specific geometric design criteria are located in the following sections: Section 216 and Section 207.10 for Design Speed; Section 217 for Sight Distance; Section 218 for Horizontal Alignment; Section 219 for Vertical Alignment; Section 220 for Combined Horizontal and Vertical Alignment; and Section 221 for Grades.

State highways through urban areas are part of the state highway network and provide connectivity to rural areas and adjacent communities and urban areas. In addition, they serve as arterials for the particular community where they reside and often are the major or principal arterial in that community. This section provides information on ODOT 3R Urban Arterial design guidance followed by the ODOT 4R Urban design guidance, and the ODOT Urban 1R and ODOT Urban Single Function design guidance. Section 203 through Section 207 cover context, context determination, general design by context, and design speed for urban locations. Horizontal alignment and superelevation, vertical curvature, grades, stopping sight distance, and cross sectional design criteria are addressed in later sections.

The primary function of an urban arterial is to serve major through traffic movements with a high level of mobility and provide limited land access. Arterials carry the highest traffic volumes and serve as the conduit for longer internal and external trips as well as for intra-area travel between city centers. However, arterials often traverse major city centers such as traditional downtowns, central business districts or regional commercial centers. In addition, due to existing land use and development patterns, arterials often are adjacent to areas of intense auto oriented development. These different land use designations can significantly affect the design of a particular arterial highway. Issues such as pedestrian movement, transit accommodation, bicycle facilities, freight routes, through traffic capacity, as well as the type of land use designation must all be considered when determining appropriate context and design for urban arterials. In order to address conflicts that arise when designing arterial highways in these locations, ODOT developed the six urban contexts described in Section 205 and Section 206, creating areas along state highways where context sensitive designs and practical solutions are needed. These six urban contexts and associated design guidance consider the 1999 Oregon Highway Plan highway segment designations and non-designated segments. *Prior criteria developed for the Special Transportation Area (STA), Urban Business Area (UBA), and Commercial Center (CC) OHP designations are policy driven. As such, these areas that exist on the state highway system by designation of the Oregon Transportation Commission (OTC) must be incorporated with current ODOT urban design contexts and design criteria when they coincide with the six HDM urban contexts along a highway corridor.* Current HDM urban design criteria are similar and have been derived from earlier urban criteria for STAs, UBAs and CCs. Incorporating the policy driven OHP segment designated sections into the HDM contexts for a project final design is not difficult. The segment designations need to be identified and documented with the project Urban Design Concurrence (UDC) documentation to ensure appropriate design parameters coincide with OHP policy. *Since there is much overlap between the OHP segment designation policy requirements and the six urban contexts listed in the HDM, this may seem redundant. However, designs must follow design criteria and policy. Identifying design compliance with policy is an important part of project documentation.*

Since arterials can traverse many different types of areas within urban growth boundaries, speed is often a major concern. Transition, design and operating speed of an arterial as it enters an urban area on the fringe, moving to areas of normal urban density and then into compact town centers, is often a challenge for a designer. However, these transition areas are often the most critical design consideration for an urban arterial as it travels through an urban area. *The designer is encouraged to utilize visual cues such as landscaping, roadside amenities, visual aesthetics, and design elements to help achieve the appropriate speed transitions for these areas and roadway sections.*

Another important aspect to Urban Arterial design is determining the appropriate design speed and target speed. *The selection of design speed and target speed is dependent on many factors that need to be carefully considered and evaluated. Section 207 and Section 216 provides*

information on selecting design speeds that should be reviewed prior to selection of a design speed for a particular project.

208.1 Rural to Urban Transitions

One of the most important elements of arterial urban highway design is the transition area. Transition areas occur when a rural highway enters an urban area, when urban expressways enter slower speed urban centers or between other different urban environments such as between a rural area and a suburban fringe. The types and treatments of transitions will vary depending upon the type of transition.

A very common type of transition is the transition from a rural high-speed highway to an urban highway. In many small communities or rural communities, the length of transition is very short. The main emphasis for a designer in these areas is to try to change the look and feel of the highway segment. This often involves establishing urban design features such as sidewalks, buffer strips, marked crosswalks, landscaping, bike lanes, raised medians, and illumination. Generally, these types of features will portray to the motorist that they are entering a changing environment that is urbanized and requires slower speeds and greater attention to pedestrians, bicyclists, and transit vehicles. Designing for the context of the roadway can also include designing for the intended operating speed of a roadway segment. Speed is part of the context of a roadway. In some of these transition areas, reducing the cross section width may be an appropriate option, but is only one of many ways to help transition speeds. Changing the roadway culture, including elements outside of the roadway section, can also help to create transition areas. Any modifications of the actual cross section elements should be consistent with the design criteria for a particular urban environment and context. Many of these standards are also applicable to transitioning from a high-to-moderate speed urban expressway to other urban environments. The key message to send to motorists is that the culture and function of the highway has changed.

Transitions to downtown/central business district type of environment are very important. These areas are often very low speed and controlling operating speeds is important to the success of these areas. A recommended approach to dealing with transitions into downtown environments is the use of a “Gateway” approach. A “Gateway” is essentially a special entry that sends a message to motorists that this is a downtown environment. Features such as curb extensions, on-street parking, wider sidewalks, pedestrian scale lighting, landscaping and/or other roadside features, are good visual cues and can be incorporated into a Gateway concept. Other tools include narrow cross sections utilizing reduced shoulder, median, shy distance, and/or lane widths. Gateways should include a vertical element that helps effect a visual narrowing. There are many different options to help achieve this result.

In summary, the goal of transition areas is to affect motorists’ perceptions of the area, establish speed expectations, establish the function of the highway, and make motorists aware that

something has changed. Designing effective transition areas is not always easy. Resources are available to assist with design concepts and strategies for transition areas. These include staff resources from Technical Services including Roadway, Bicycle and Pedestrian Program, and Traffic Management units, as well as written guidance from *Main Street... When a Highway Runs Through It: A Handbook for Oregon Communities*, DLCD/ODOT; *Oregon Roadway Design Concepts*, ODOT; and *Metro's Street Design Guide, Creating Livable Streets - Street Design Guidelines for 2040*, the NACTO *Urban Street Design Guide*, as well as others.

Section 209 ODOT 3R Urban Design Standards

This section discusses the appropriate design standards for urban non-freeway arterial highway projects and is applicable to arterials, collectors, and local streets. Specific geometric design criteria are located in the following sections: Section 216 and Section 207 (207.10) for Design Speed; Section 217 for Sight Distance; Section 218 for Horizontal Alignment; Section 219 for Vertical Alignment; Section 220 for Combined Horizontal and Vertical Alignment, and Section 221 for Grades.

In general, the intent of 3R projects is pavement preservation with additional focus on safety items. Some of those safety items include mandatory 3R design features such as ADA curb ramps and deficient guardrail, consideration of low-cost safety mitigation measures, and in the case of urban arterials, the corrective measures located in the 3R urban preservation strategy. The Urban Preservation Strategy adds design guidance, which provides statewide consistency in the urban preservation program.

A design feature not meeting the standards as specifically noted in the following areas: roadway width; bridge width; horizontal curvature; vertical curvature and stopping sight distance; pavement cross slope; superelevation; vertical clearance; ADA; or pavement design life must be upgraded or a design exception must be documented and approved. For more information on these criteria and other safety-conscious design considerations, the designer should become acquainted with "TRB Special Report #214", and NCHRP Report 876 "Guidelines for Integrating Safety and Cost-Effectiveness into Resurfacing, Restoration, and Rehabilitation (3R) Projects".

Once the decision is made to upgrade a roadway feature, the designer uses the *ODOT Highway Design Manual*, the AASHTO publication "A Policy on Geometric Design of Highways and Streets" (Green Book), the AASHTO "Roadside Design Guide" or "TRB Special Report #214", or NCHRP Report 876 "Guidelines for Integrating Safety and Cost-Effectiveness into Resurfacing, Restoration, and Rehabilitation (3R) Projects", whichever gives guidance in the particular area of need. When evaluating intersections, consider turning radius to facilitate truck movements as well as intersection sight distance.

Section 210 ODOT 4R Urban Design Criteria

As discussed previously in this Part, ODOT has developed six urban contexts for urban arterials, which include: traditional downtown/commercial business district; urban mix; commercial corridor; residential corridor; suburban fringe; and rural community. In addition to the design guidance in Part 200, cross section design criteria have been developed and are located in Part 300 (Cross Section Elements). Each of the different urban contexts come with a recommended range of design criteria. Selecting values within the ranges of recommended guidance does not require a design exception. Appropriate values are documented in the Urban Design Concurrence Document (UDC). Going below the minimum value in the recommended guidance does require a design exception and discussion with Technical Services, Roadway staff as early as possible in the project development process is encouraged.

Guidance for Specific geometric design criteria are located in the following sections: Section 216 and Section 207 (207.10) for Design Speed; Section 217 for Sight Distance; Section 218 for Horizontal Alignment; Section 219 for Vertical Alignment; Section 220 for Combined Horizontal and Vertical Alignment; and Section 221 for Grades.

Section 211 ODOT 1R and Single Function Urban Design Standards

1R and Single Function applicable design criteria and requirements for urban roadways is located in Part 300 (Cross Section Elements) as the 1R projects are typically paving only projects. Single Function projects are to use the 4R standard.

Section 212 Role of Planning Documents and Design Criteria

Coordinating planning activities with project design is critical to ensure decisions and commitments made during the planning process are incorporated into final project designs. This is particularly important in urban locations where community desires of local jurisdictions have been included in long range planning documentation. Planning documents such as corridor plans, refinement plans, regional or local transportation system plans, and facility plans including Interchange Area Management Plans (IAMPs) provide valuable guidance to designers. These documents have undergone extensive public involvement to select the type and level of infrastructure improvements that address the identified problems. The designer needs to be aware of and understand the context of the recommendations contained in these

planning documents when preparing project designs. *Contact the Region Planning Manager and staff to help identify and interpret the information in these plans. In the case of Interchange Area Management Plans (IAMP) and other types of planned facility designs the Chief Engineer's approval is required.*

The types of plans discussed above are all plans adopted by local jurisdictions and/or the Oregon Transportation Commission. Therefore, transportation improvement projects must be consistent with these adopted plans. Design elements and features on State Highways must meet ODOT Design Standards. The Department cannot construct, fund or permit design elements or features that do not meet standard criteria unless a Design Exception has been approved by the State Traffic-Roadway Engineer. Because pertinent information may not be available in these early planning processes, exceptions to design standards are typically processed during project development and are approved in writing at that time. Similarly, any traffic control changes such as traffic signals, signing, or striping must have the written approval of the State Traffic-Roadway Engineer.

However, since Transportation Plans commonly have design elements and features of State Highways discussed in them, there are times when deviations to design standards need to be addressed during planning to ensure they are incorporated in the final project development when the planning documents are actually implemented. These design elements and features may include roadway cross-sections, centerline alignments, interchange layout configurations, bike facilities, sidewalks, shoulders, and shared use paths.

Issues corresponding to interpretation can occur when the design elements and features shown in Transportation Plans differ from those in the Highway Design Manual. Since ODOT prepared, funded or reviewed the plan, local government or the public often think that the design elements and features shown have been approved by ODOT and that ODOT will construct or allow the construction of these elements and features according to the plan. Unless a Design Exception has been previously sought, future projects linked to an adopted plan may be required to follow ODOT standards regardless of the design elements or features that may have been identified in the plan.

To avoid this problem, planning studies that lead to potential adoption of plans affecting the state highway system that include, but are not limited to, Regional Transportation Plans, Regional Mobility Plans, Interchange Area Management Plans (IAMP), Transportation System Plans, or other local Mobility Plans should follow ODOT Design Standards or seek a Design Exception; Part 1000 of the Highway Design Manual describes the Design Exception process. With the introduction of performance-based, practical design and greater flexibility for urban locations, it is important to address how context related design criteria will be developed to ensure future projects meet desired goals and outcomes of the planning process.

Below are some guidelines for inclusion of design elements and features in planning documents that include State Highways:

1. Don't show specific dimensions for any design elements.
2. If you do show dimensions, they should be to ODOT standards.
3. For planning studies that have non-standard design elements and features that may be constructed within five years, obtain a Design Exception before incorporation of dimensions into the final plan.
4. For planning studies that have non-standard design elements and features that may be constructed within five to ten years, submit a Draft Design Exception request and obtain a written indication or concurrence that a Design Exception is warranted and would probably be approved from the State Traffic-Roadway Engineer before incorporation of dimensions into the final plan.
5. Planning documents cannot select an alternative with non-standard elements or features as the preferred alternative unless a Design Exception has been obtained or the State Traffic-Roadway Engineer has indicated that one would probably be approved.
6. In consideration of overall safety along a highway segment, proposed cross-sections with multiple non-standard design elements should be avoided. When avoidance is not possible, the cumulative effect on operations and safety of introducing multiple non-standard elements in the same cross-section must be considered and evaluated carefully.

Planning documents are often long range. Their use is for planning land use and infrastructure options over 15 and 20-year periods of time or more. These long-term plans designate future areas of development. Designers must ensure the safety of all users when designing projects that travel through these future areas of development. Consideration should be given to long range planning efforts and how those efforts impact the proposed roadway projects. The designer should work with the Project Team, Region Planning Manager, and/or Area Manager to gain a better understanding of the planning efforts and processes completed or underway for a particular area.

Section 213 Urban and Rural Freeway Design

This section provides guidance for standards on urban and rural freeways for 3R, 4R, 1R, and Single Function design projects. Specific geometric design criteria are located in the following sections: Section 216, Design Speed; Section 217 for Sight Distance; Section 218 for Horizontal Alignment; Section 219 for Vertical Alignment; Section 220 for Combined Horizontal and Vertical Alignment; and Section 221 for Grades. Cross sectional design guidance is addressed in Part 300.

The designer must be aware of which standards apply and choose the appropriate standard when dealing with freeways. The practical design strategy and design flexibility play a role in providing guidance for the designer in project design and development. Whether a freeway project is single function, 1R, 3R, or 4R, sound engineering judgment and decision making is required. *The designer, working with the project team, should keep project scope, purpose and need, and the Practical Design values of Safety, Corridor Context, Optimize the System, Public Support, and Efficient Cost (S.C.O.P.E.) in mind when making project design decisions.*

Freeways are the highest form of arterials and have full access control. The full control of access is needed for prioritizing the need for through traffic over direct access. A freeway's primary function is to provide mobility, high operating speed, and level of service, while land access is limited. Access connections, where deemed necessary, are provided through ramps at grade separated interchanges. The major advantages of access-controlled freeways are high capacity, high operating speeds, operational efficiency, lower crash potential, and safety to all highway users.

The major differences between freeways and other arterials include the following elements: grade separations at crossroads and streets; the grade separated cross road connections between the freeway and crossroad are accomplished through exit and entrance ramps; and full control of access. *Oregon Highway Plan designated expressways can be designed with both freeway and non-freeway design elements. However, the two design types should not be intermixed in close proximity to each other. Consistency of design elements should be carried for reasonable distances for continuity and driver expectancy and understanding.* The use of jug handle style interchanges and use of right turn channelization is not considered freeway design but can be used in expressway design. The long-term corridor and planning goals should be considered when deciding whether or not to design an expressway to freeway standards. (See Section 214 for additional information on expressways and the decision to design expressways as freeways).

The Freeway 3R Design Standards apply to both urban and rural freeway conditions for preservation or Interstate Maintenance projects. All new freeways or modernization of existing freeways are to use the 4R/New standards.

213.1 ODOT 3R Freeway Design Standards

When a project on the freeway system has been classified as 3R, the standards and guidance outlined in the following sections apply. The development of a freeway 3R project should also be responsive to the considerations concerning purpose, applicability, scope, determination, and design process. The 3R standards for those specific listed elements are based on the 2018 AASHTO publication, "A Policy on Design Standards-Interstate System", which provides guidelines for work on the Interstate system. The standards provided are considered as allowable minimums. **For those design elements not specifically addressed, the guidelines in**

the AASHTO Green Book are to be followed. 3R projects that include specific horizontal and vertical curve corrections are to use ODOT 4R standards for those curve correction design elements. In addition to these standards, Interstate Maintenance Design Features in Part 300 are to be incorporated into all interstate freeway 3R projects. The “Have To” list is the minimum treatment for the listed project elements. *The “Like To” list includes treatments for elements which should be considered when economically feasible, i.e., minimal extra cost, or funds available from sources other than the Preservation Program.*

Technical Resources have been identified for a number of the project elements. These resources should be utilized by the Project Team to aid in determining if a “Like To” measure is warranted, cost-effective and fundable or if a design exception should be sought to do less than the “Have To” requirements. Design exceptions should be identified as soon as possible (typically during project scoping), and the appropriate design exception request officially submitted for approval as soon as all pertinent information can be determined and analyzed. Design exceptions are covered in Part 1000.

213.2 ODOT 4R Freeway Design Standards

Urban freeways generally have more travel lanes and carry more traffic than rural freeways. Urban freeways can be either depressed, elevated, at ground level, or a combination of the above mentioned. Urban freeways usually have a narrower median than rural freeways due to the high cost of obtaining right-of-way. In addition, urban freeways tend to have more connections than rural freeways but complying with interchange spacing requirements is critical to maintaining a high level of long-term freeway operations.

Rural freeways are generally similar in concept to urban freeways, except that the horizontal and vertical alignments are more generous in design. This level of design is normally associated with higher design speeds and greater potential for available right of way. Due to the nature of the facility, right of way is typically more available and less expensive in a rural setting. This allows for a wider median which improves the safety of the facility. In addition to the increase in safety of a rural freeway, the higher design speeds in a rural setting allow for greater capacity, a higher level of mobility, and potentially a reduced need for multiple lanes. Rural freeways are normally more comfortable from a driver perspective, and generally have lower maintenance costs.

213.3 ODOT 1R and 4R Single Function Freeway Design Standards

1R and 4R Single Function applicable design criteria and requirement for freeways is located in Part 300 (Cross Section Elements). 1R projects are typically paving only projects. Single Function projects are 4R projects with a very limited scope of work.

Section 214 Urban and Rural Expressway Design

Section 214 provides 3R, 4R, 1R and single function design guidance for urban and rural expressways. Specific geometric design criteria are located in the following sections: Section 216 and Section 207 (207.10) for Design Speed; Section 217 for Sight Distance; Section 218 for Horizontal Alignment; Section 219 for Vertical Alignment; Section 220 for Combined Horizontal and Vertical Alignment; and Section 221 for Grades.

Urban and rural highways can take several forms: freeways, expressways, arterials, collectors, and sometimes, local roads. Similar to urban and rural freeways, urban and rural expressways are a designation identified in the Oregon Highway Plan and mainly focus on vehicle mobility, although expressways may not have similar levels of access control as freeways. The following is from the Oregon Highway Plan:

“Expressways are complete routes or segments of existing two-lane and multi-lane highways and planned multi-lane highways that provide for safe and efficient high speed and high-volume traffic movements. Their primary function is to provide for interurban travel and connections to ports and major recreation areas with minimal interruptions. A secondary function is to provide for long distance intra-urban travel in metropolitan areas. In urban areas, speeds are moderate to high. In rural areas, speeds are high.”

Because expressways may consist of grade separated or at-grade intersections, the level of modal accommodation will vary. Speeds are often relatively high ranging from 45 to 70 mph depending on urban or rural environments.

Designing urban and rural expressway highway projects presents designers with a variety of challenges. Designers must balance the needs of autos, trucks, transit, bicyclists, and pedestrians, while considering highway function, speed, safety, alignment, channelization, right of way, environmental impacts, land use impacts, and roadside culture. Part 200 addresses the design standards for design speed, horizontal alignment and superelevation, vertical curvature, grades, and stopping sight distance while cross sectional design criteria are addressed in Part 300. This section discusses a variety of issues, concerns, and areas for consideration when designing urban and rural expressways.

One critical distinction when designing a project on an urban expressway is if the section has grade-separated intersections or if intersections are at-grade.

- *If the urban expressway section has at-grade intersections, then the six urban contexts and their respective design criteria apply to determine appropriate design decisions and the Urban Design Concurrence document is used. (Section 202 – Section 207 and Part 300)*
- *If the urban expressway section has grade-separated intersections (interchanges), then design decisions are based on freeway and higher operating speed design criteria.*
- *In locations where the urban expressway is a mixture of both grade-separated interchanges and at-grade intersections, the project team and the Region Roadway Manager will need to determine if the section fits with any of the six urban contexts or if higher speed freeway design should be used. Generally, if the majority of the access points are grade-separate and the roadway is operating like a freeway even though it may not be a multi-lane roadway, then freeway design criteria should be used. If the roadway is operating more as an urban arterial street with mostly at-grade intersections, then it could potentially fit into one of the six urban contexts.*

214.1 ODOT 3R Urban and Rural Expressway Design Standards

The 3R expressway design guidance for urban and rural expressways are generally the same as the 3R urban and rural arterial design guidance. Part 300 provides additional information for urban expressway 3R design. In general, the intent of 3R projects is pavement preservation with additional focus on safety items. Some of those safety items include mandatory 3R design features such as ADA curb ramps and deficient guardrail, consideration of low-cost safety mitigation measures, and in the case of urban expressways, the corrective measures located in the 3R urban preservation strategy.

214.2 ODOT 4R Urban Expressway Design Standards

Urban expressways are generally high-speed, limited access facilities whose function is to move both inter-urban and intra-urban traffic. Mobility is a high priority. Expressways may often serve as major freight corridors as well as being designated as an OHP Freight Route. They are often part of the National Highway System (NHS). Private property access is discouraged in favor of through mobility importance. Access is normally restricted to at-grade signalized and unsignalized public road intersections or grade-separated interchanges. At-grade signalized intersections may provide full access. However, at-grade, unsignalized intersections should be

considered carefully and for safety reasons, it is desirable to limit them to a right-in, right-out condition. In areas where there is no other reasonable access, private approach roads may be allowed. Private approach road connections to expressways need to be considered and evaluated carefully in order to minimize safety risks and to address driver expectancy related to the context and roadside culture and should also be limited to a right-in, right-out condition. *Expressways may have a mixture of at-grade intersections and interchanges. However, the mixing of at-grade intersections with grade separated interchanges in proximity to each other should be kept to a minimum.* Drivers may become confused in their perception of expectations at the different connection styles causing undesirable actions on their part as they interact with other vehicles entering or leaving the roadway. Some expressways may become freeways in the future and therefore should be designed, operated, and managed at the highest level to ensure long-term operations. The transitioning of urban roadways to expressways should take into account the long-term plan for the roadway, which can impact the design of the facility.

214.3 ODOT 4R Rural Expressway Design Standards

Expressways are designated by the OTC. They are allowed on statewide, regional and district classified highways. Expressways are generally high speed, limited access facilities whose main function is to provide for safe and efficient high speed and high-volume traffic movements. Since expressways are specifically designated from the overall planning of the state highway system, design of expressways must maintain the functionality of the roadway. In higher speed rural settings, vehicle mobility is a high function. In lower speed urban settings where the expressway may fit into one of the ODOT six urban contexts, vehicle mobility is still of high importance; However, overall vehicle mobility must also be balanced against other urban transit, bicycling, and pedestrian needs. In balancing these needs, trade-offs are necessary to provide appropriate facilities and safe access for all users and in some cases, not all modes will be able to be accommodated. When the expressway functionality of the highway is determined the greater need, transit riders, bicyclists, and pedestrians may need to be served in another manner or on adjacent facilities. *The project development team must determine appropriate design that accomplishes project goals and outcomes, while producing a final design that minimizes conflicts between transportation modes and provides access to the highway system for all users.* Part 300, Section 310.13 provides guidance for pedestrian design on expressways. Part 800 and Part 900 also provide design considerations for pedestrians and for bicyclists on expressways, as well as for other roadway types.

Expressway designation is not limited to multi-lane roadways. Rural two-lane highways can also be designated as expressways. The Dalles-California Highway (US 97) in Central Oregon is an example of a designated expressway that includes both multi-lane sections and two-lane sections. The primary function of rural expressways is to provide connections to larger urban areas, ports, and major recreational areas with minimal interruptions. Rural expressways may also serve as major freight corridors or may be located on Freight Routes. Private access is

discouraged, and public intersections are highly controlled. *Rural expressways may utilize at-grade intersections or grade separated interchanges. However, the mixing of at-grade intersections with grade separated interchanges in proximity to each other should be kept to a minimum.* Drivers may become confused in their perception of expectations at the different connection styles causing undesirable actions on their part as they interact with other vehicles entering or leaving the roadway. Some expressways may become freeways in the future and therefore should be designed, operated, and managed at the highest level to ensure long-term operations. The transitioning of rural roadways to expressways should take into account the long-term plan for the roadway, which can impact the design of the facility.

High level roadways, although classified as expressways, may operate more as a freeway. These expressways have grade separations in place of at-grade intersections and are fully access controlled. When high level expressways meet the operational definition of freeways, the expressway should be designed with freeway standards. This means many of the design elements such as left turn lanes, striped medians, and right turn lanes would not apply.

214.4 ODOT 1R and Single Function Urban and Rural Expressway Design Standards

1R and Single Function applicable design criteria and requirements for expressways are located in Part 300 (Cross Section Elements) as the 1R projects are typically paving only projects. Single Function projects are to use the 4R standard.

Section 215 Rural Arterial, Collector, and Local Route Design

This section provides guidance for general design of Rural Arterial, Collector, and Local Routes on 3R, 4R, 1R, and Single Function design projects. Specific geometric design criteria are located in the following sections: Section 216 for Design Speed; Section 217 for Sight Distance; Section 218 for Horizontal Alignment; Section 219 for Vertical Alignment; Section 220 for Combined Horizontal and Vertical Alignment; and Section 221 for Grades. Cross sectional design criteria are addressed in Part 300.

Rural highways make up a large percentage of the state highway mileage. Rural highways cover the widest range of geographical and topographical conditions. Rural highways connect all parts of the state to each other. Rural highway designs should provide the safest cost-effective solutions. This Part also discusses how to design highways that are Scenic Byways and highways that travel through the many rural communities located throughout the state.

The arterial road systems provide a high speed and high-volume travel network between major points in urban and rural areas. Rural arterials consist of a wide range of roads, from multi-lane rural expressways to low volume, two lane roads. Most rural state highways in Oregon are functionally classified as arterials as they serve the greatest traffic volumes and provide critical connections to the larger urban areas, ports, multi-modal facilities, and recreational areas. However, some state highways serve very low volumes of traffic and are classified as collectors or local roads. The design standards and guidelines contained in this chapter are only to be used for non-freeway rural highway design. Rural freeway design is covered in Part 600.

215.1 ODOT 3R Rural Arterial, Collector, and Local Route Design Standards

This section discusses the appropriate design standards for rural non-freeway highway projects and is applicable to arterials, collectors, and local streets. In general, the intent of 3R projects is pavement preservation with additional focus on safety items. Some of those safety items include mandatory 3R design features such as ADA curb ramps and deficient guardrail. Low-cost safety mitigation measures should also be considered with these projects.

Non-freeway 3R projects should be developed in line with the S.C.O.P.E. values of Practical Design presented in Part 100. **A feature not meeting the standards as specifically noted for the following items: roadway width, bridge width, horizontal curvature, vertical curvature and stopping sight distance, pavement cross slope, superelevation, vertical clearance, ADA, or pavement design life must be upgraded, or a design exception must be documented and approved.** For more information on these criteria and other safety-conscious design considerations, the designer should become acquainted with “TRB Special Report #214-Designing Safer Roads-Practices for Resurfacing, Restoration, and Rehabilitation”.

Once the decision is made to upgrade a roadway feature, the designer should use the ODOT Highway Design Manual, the AASHTO Green Book, TRB Special Report #214, or NCHRP Report 876 “Guidelines for Integrating Safety and Cost-Effectiveness into Resurfacing, Restoration, and Rehabilitation (3R) Projects”, whichever gives guidance in the particular area of need. When evaluating intersections within a 3R project, turning radius to facilitate truck movements should also be considered as well as intersection sight distance.

215.2 ODOT 4R Rural Arterial, Collector, and Local Route Design Standards

215.2.1 ODOT 4R Rural Arterial Design Standards

Most rural state highways are classified as arterial roadways. Appendix A contains a listing of the functional classification of all state highways. Corridor Plans and county Transportation System Plans (TSPs) also need to be reviewed to ensure that the highway classification is correct. *Where discrepancies exist between the tables in Appendix A and the classifications assigned by a Corridor Plan or TSP, the higher classification is used. The context must also be considered. Some rural highways with less than 5000 ADT are classified as rural arterials, yet go through small cities with a posted speed of 25 to 30 mph. In these locations, urban standards are appropriate and careful consideration must be given to the transition from a high-speed to low-speed environment.* Section 216 through Section 221 provides ODOT 4R/New Rural design standards for the design of reconstruction and new construction projects on rural highways.

215.2.2 ODOT 4R Rural Collector Design Standards

Collectors serve two very important functions. First, collectors provide mobility to and from the arterial streets. Second, collectors provide land access to abutting properties. Due to their dual purpose, collectors have mobility characteristics that are just below those of an arterial and just above those of a local street.

The design elements of collector roads are similar to the design elements of arterials, although typically the range of values is slightly less demanding. Design speeds are normally lower than those for arterials, steeper grades are allowed, and lane and shoulder widths are generally narrower.

The different design standards for rural collectors can be found in Section 216 through Section 221. Additional information on collectors can be found in Chapter 6 of the AASHTO Green Book.

215.2.3 ODOT 4R/New Local Rural Route Design Standards

A rural local route's primary function is to provide access to rural areas. Local routes account for a very large proportion of the roadway mileage in the State. Local routes normally carry very low volumes; therefore, design standards for local routes are generally lower than those standards for collectors and arterials. Design speeds are lower, steeper grades are allowed, and travel lanes and shoulder widths are generally narrower.

Additional information on rural local routes can be found in Chapter 5 of the AASHTO Green Book.

215.3 ODOT 1R and Single Function Rural Arterial, Collector, and Local Route Design Standards

1R and Single Function applicable design criteria and requirements for rural arterials, collectors, and local routes are located in Part 300 (Cross Section Elements) as the 1R projects are typically paving only projects. Single Function projects are to use the 4R standard.

Section 216 Design Speed

216.1 ODOT 3R Urban and Rural Design Speed-All Highways

The design speed for 3R projects will generally be the posted speed, but consideration of context, environment and existing features may result in the selection of a speed greater than the posted speed as the design speed. However, the design speed selected shall not be less than the posted speed. The intent of a 3R project is to preserve the existing pavement by resurfacing or rehabilitating the roadway, extend the service life of the facility, and provide effective safety countermeasures or include safety enhancements. General federal guidance notes that the geometric design should be consistent with speeds implied by the posted or regulatory speed. With the design speed being equal to the posted speed, drivers will be able to operate at the posted speed without exceeding the safe design speed of the facility. There may also be rare occasions where the Region's goals for a section of roadway would call for selecting a design speed that is higher than the posted speed.

216.2 ODOT 4R Urban and Rural Freeway Design Speed

In general, the design speed of freeways should be similar to the desired running speed during off peak hours, keeping in mind a reasonable and prudent speed. In some urban areas, with populations under 50,000, the posted freeway speed is 65 mph. In more densely populated urban areas (over 50,000), the posted speed is 55 or 60 mph, or in constrained areas, 50 mph. Because of the different posted speeds, the design speed chosen may vary. In many urban areas the amount of available right of way can be restricted and achieving high design speeds can be very costly. *In balancing the need for safety and providing a high-speed facility with*

consideration for right of way costs, the design speed for urban freeways shall be a minimum of 50 mph. A 50 mph design speed may only be used in very constrained urban corridors or in mountainous terrain, and the design speed must be consistent with the corridor and meet driver expectancy. On most urban freeway corridors, a design speed of 60 mph can be provided with little additional cost. In situations where the corridor is relatively straight and the character of the roadway and location of interchanges permit a higher design speed, 70 mph should be used.

For rural freeways the design speed is 70 mph, except that in mountainous terrain, a design speed of 50 to 60 mph may be used. The design speed must be consistent with the corridor and meet driver expectancy.

Rural freeways outside of mountainous terrain generally have higher design speeds. Normally right of way is more available in rural locations allowing for more generous horizontal and vertical alignments. These higher design speeds allow for increased volumes and capacity while providing a safe facility and a more comfortable driving environment. Increased capacity leads to improvements to the level of mobility standards and a facility that will operate longer than a lower design speed urban freeway. **For all freeway projects, the design speed is to be selected by the Region Roadway Manager and the Region Traffic Manager in cooperation with Technical Services Roadway staff.**

Other sections discuss design speed selection for the design of 3R, 1R, and Single Function projects. Table 200-9 provides suggested design speed values for various roadways.

216.3 ODOT 4R Urban Expressway Design Speed

The design speed of an expressway is a critical element for determining the appropriate standard to be applied to a given segment. *Expressways are usually high-speed roadways and should be designed appropriately. Most urban expressways should be designed based upon a 55 mph design speed or higher. In more restrictive urban environments, a 50 mph design speed may be more appropriate. A 45 mph design speed may be considered only in highly constrained areas and retrofit situations.* Several factors including planned operating speeds, amount of access control, use of at-grade intersections, use of grade separations and topography play major roles in determining the appropriate design speed. Some Urban Expressways may have the look and feel of a Freeway. In these instances, it is important to recognize the context and resultant driver expectation. Table 200-9 provides suggested design speed values for various roadways.

216.4 ODOT 4R Rural Expressway Design Speed

Rural expressways carry high speed and high-volume traffic and should be designed accordingly with the function of the facility. *Rural expressway design speeds should be designed*

for a minimum 50 mph design speed in mountainous areas, 60 mph in rolling terrain, and 60 or 70 mph in flat terrain. Expressways may in time evolve into freeways and the chosen design speed should allow for that facility type transition. Table 200-9 provides suggested design speed values for various roadways.

216.5 ODOT 4R Rural Arterial Design Speed

Rural arterials have a wide range of design speed depending on the terrain, traffic volume, location of facility, and driver expectancy. *Design speeds range from 45 mph in mountainous terrain and low volume to 60 or 70 mph on level terrain. A 60 mph design speed works well for most of Oregon's rural two-lane highways. In general design speeds on level terrain range from 60-70 mph; rolling terrain design speeds in rural areas range from 50-60 mph; and mountainous terrain design speeds range from 45-50 mph.* A 45 mph design speed in mountainous terrain or a 50 mph design speed in rolling terrain would only apply where the traffic volumes are low. The design speed in rural communities will vary according to community characteristics. Rural arterials also traverse rural towns and communities. In these areas, determine design speed based on adjacent land use, community needs and overall operations. Table 200-9 provides suggested design speed values for various roadways.

216.6 ODOT 4R Rural Collector and Local Route Design Speed

The ODOT 4R Rural Collector and Local Route Design Speed requirements can be found in Table 200-9.

216.7 ODOT 4R Urban Arterial Design Speed

With development of the Blueprint for Urban Design, ODOT developed a relationship between target speed, design speed, posted speed, and the operating speed of an urban roadway to provide direction for ODOT urban arterial design speeds. Design and speed management treatments were developed to help achieve the range of target speeds for the urban contexts. *The overall long-term goal is for the design speed, posted speed, and target speed to be the same in most urban locations, but in no case, can the design speed of urban arterials be less than the posted speed.* As an aspirational goal, target speed may be shown below posted when speed reduction is defined as a project goal. Additional information on target speed and recommendations for design speed and target speed are discussed in Section 207.10, Speed, Context and Design. Table 200-9 provides suggested design speed values for various roadways.

Table 200-9 Design Speed Selection

DESIGN SPEED				
FUNCTIONAL CLASSIFICATION/CONTEXT	Terrain or Characteristic			
	Flat	Rolling	Mountainous	Urban
Interstate/Freeway	70	70	50-70	50-70
Urban Expressway	45-70			
Rural Expressway	50-70			
Rural Arterial	45-70			
Rural Collector	45-70			
Rural Local Route	45-50			
ODOT URBAN CONTEXTS	DESIGN SPEED/TARGET SPEED			
Traditional Downtown/CBD	20-25	Speeds shown for Urban Contexts are considered aspirational “target speeds” anticipated for each context. Actual selected project design speed shall not be less than posted speeds. In cases where desired target speed is less than posted speed, design speed is set at posted speed and design treatments are employed to reduce operating speed.		
Urban Mix	25-30			
Commercial Corridor	30-35			
Residential Corridor	30-35			
Suburban Fringe	35-40			
Rural Community	25-35			

Section 217 Sight Distance

217.1 General

Sight distance is the unobstructed distance of roadway ahead visible to the driver. There are multiple types of sight distance that include stopping sight distance, passing sight distance, decision sight distance and intersection sight distance. It is critical that sight distance issues be properly developed and applied to projects.

Check horizontal sight distance when designing slopes and retaining walls or where median barriers, raised medians, center piers, structure screening or screen plantings are used.

Combinations of slight horizontal curvature with crest vertical curves may seriously diminish sight distance where barrier, high curbs or plantings are used. *Set slopes, walls and other side obstructions back from the pavement edge to provide at least minimum stopping sight distance for a driver in the traffic lane nearest the obstruction. Take into consideration the possibility of future conversion of shoulders or parking areas to driving lanes.*

For intersections at grade, a vehicle entering the highway from a side street or access must be able to clearly see a vehicle throughout the sight triangle based on minimum stopping sight distance and preferably intersection sight distance for the design speed. It is desirable to provide sufficient sight distance so that the entering vehicle may cross or make a turn without significant slowing of the through traffic. On high-speed, high-volume roadway intersections, providing intersection sight distance, rather than the minimum stopping sight distance, will minimize operational and safety problems. Horizontal sight distance, as measured 2 feet above the centerline of the inside lane at the point of obstruction, must at least equal the stopping sight distance. When the normal cut bank reduces the horizontal sight distance below the stopping sight distance for the design speed, the cut bank is flattened or benched.

Vertical curves designed to the minimum stopping sight distance may need to be flattened to obtain intersection sight distance, passing sight distance, etc. All forms of sight distance must be checked and provided for as appropriate. Required stopping sight distance is shown in Table 200-10. Figure 200-16 indicates how sight distances are measured.

Urban locations with limited right-of-way, on-street parking, utility poles, street trees, signs, etc. provide significant challenges in meeting sight distance requirements and take specific analysis to determine appropriate design. Approved Design Exceptions are required where relocation of sight obstructions is infeasible or impossible.

217.2 Stopping Sight Distance

Stopping sight distance is the minimum distance required for a vehicle traveling at a particular design speed to come to a complete stop after an obstacle on the road becomes visible. Stopping sight distance is normally sufficient to allow an alert and prudent driver to come to a hurried stop under normal circumstances. Stopping sight distance is measured from the driver's eye (assumed to be 3.5 feet above the roadway surface) to an object 2 feet above the roadway surface. Stopping sight distance is the summation of two distances: the distance traveled by a vehicle from the time the driver sees an object that requires a stop to the instant the brakes are applied, and the distance required to stop the vehicle from the time the brakes are applied. These two distances are called brake reaction distance and braking distance. Table 200-10 contains the stopping sight distance minimums.

Stopping sight distance must, at a minimum, be obtained on all vertical and horizontal alignments. Figure 200-50 and Figure 200-51 show the minimum stopping sight distance requirements for crest and sag vertical curves (See Part 600, Table 600-4 for sight distance on

ramps). Figure 200-17 indicates the minimum stopping sight distance for horizontal curves. Care must be taken to ensure that these minimum distances are obtained in project design. Roadside elements such as cut slopes, guardrail, tunnels, retaining walls, bridge rail, and barriers can obstruct the view of the driver and must be properly located to ensure that proper stopping sight distance is achieved. As noted previously, other types of sight distance may control in a design, as well. For example, it would be desirable to flatten a crest vertical curve in order to provide full intersection sight distance from a side street.

Highway grades can have a significant effect on stopping sight distances. Refer to [Figure 200-16](#) for manually determining Stopping Sight Distance. Table 3-1 on page 3-4 of the 2018 AASHTO Green Book provides Stopping Sight Distance values for level roadways. For information about the effects of grades on Stopping Sight Distances, see Table 3-2 on page 3-6 of the 2018 AASHTO Green Book.

Figure 200-16: Determining Stopping Sight Distance

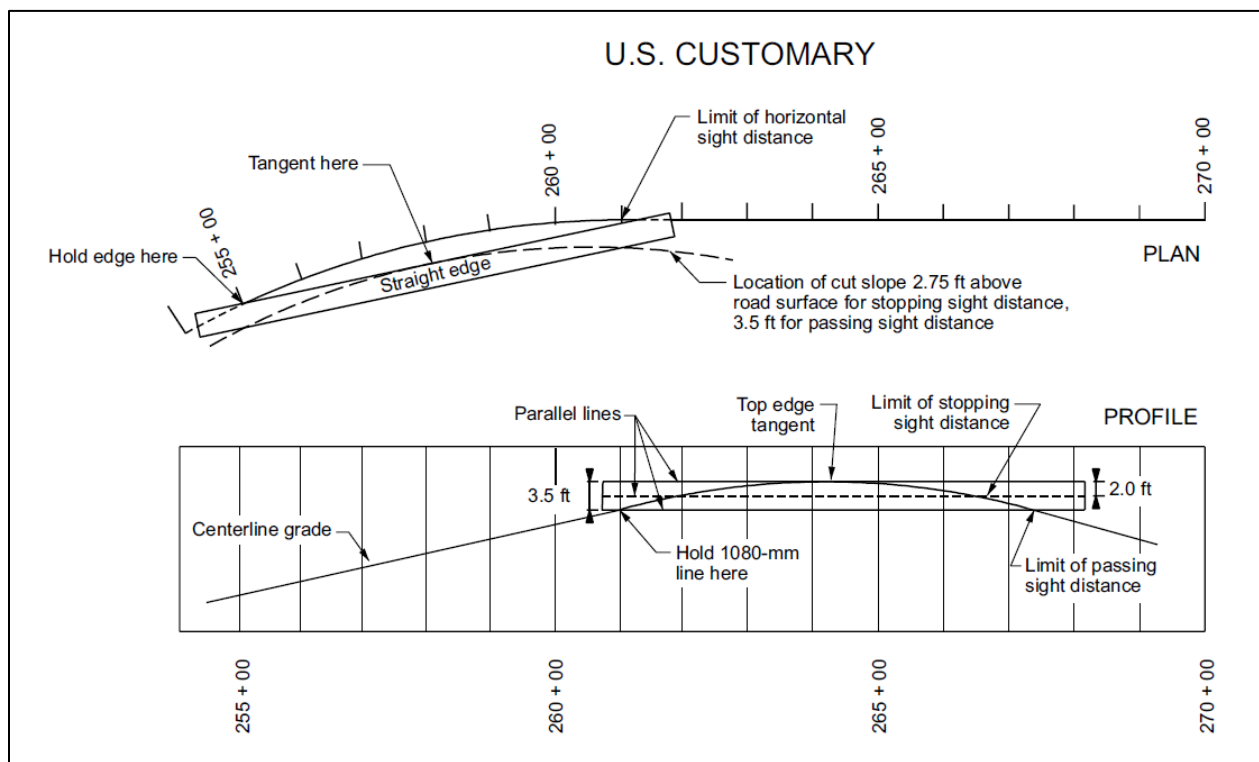

Source: AASHTO 2018

Table 200-10: Stopping Sight Distance

Design Speed	Stopping Sight Distance
25 mph	155 ft.
30 mph	200 ft.
35 mph	250 ft.
40 mph	305 ft.
45 mph	360 ft.
50 mph	425 ft.
55 mph	495 ft.
60 mph	570 ft.
65 mph	645 ft.
70 mph	730 ft.

Source: 2018 AASHTO

217.3 Decision Sight Distance

Many times, the elements of the roadway become complex and require additional distances for drivers to make the proper maneuver. Human factors can play a huge role in how a particular driver perceives and reacts to roadway design and conditions. As roadway systems experience an aging population of drivers, the range of human factors of that demographic becomes increasingly important. Older drivers often experience declining vision acuity, reduced body movement affecting head turning ability and other physical movement, increase in reaction time, and changes in cognitive function to name a few. For more information in human factors and considerations for roadway design, see NCHRP Report 600, Human Factors Guidelines for Road Systems, second edition. For assistance with interpreting the document, contact ODOT Technical Services, Traffic-Roadway Section.

In addition to older driver concerns, distracted driving is another human factor to consider. Stopping sight distance may not be adequate when drivers must process complex roadway information in an instant or when the roadway information is difficult to decipher or unexpected. When possible, endeavor to provide decision sight distance at locations where multiple information processing, decision making, and corrective actions are needed. Sample locations where decision sight distance is needed include unusual intersection or interchange

configuration and lane drops. If site characteristics allow, locate these highway features where decision sight distance can be provided. If this is not practicable, use suitable traffic control devices and positive guidance to give advanced warning of the conditions. Work with the Region Traffic Engineer on the need for decision sight distance at certain locations - also if there is need for additional signing, illumination, etc. Decision sight distance is calculated using the 3.5-foot eye height and the 2-foot object height that is also used for stopping sight distance. Pages 3-7 thru 3-9 of the 2018 AASHTO Green Book provide more information on decision sight distance.

217.4 Intersection Sight Distance

Obtaining intersection sight distance is important in the design of intersections. Intersection sight distance is considered adequate when drivers at or approaching an intersection have an unobstructed view of the entire intersection and of sufficient lengths of the intersecting highways to permit the drivers to anticipate and avoid potential collisions. Sight distance must be unobstructed along both approaches at an intersection and across the corners to allow the vehicles simultaneously approaching, to see each other and react in time to prevent a collision. Intersection sight distance is determined by using a 3.5 foot eye height and a 3.5 foot height of object.

It is desirable to provide intersection sight distance at every road approach, whether it is a signalized intersection or private driveway. On high-speed, high-volume roadway intersections, providing intersection sight distance will minimize operational and safety problems and is a prudent goal. However, in some locations, intersection sight distance may not be obtainable. In these instances, minimum stopping sight distance is required. However, many urban locations present specific challenges to meeting either intersection sight distance or minimum stopping sight distance. **In these locations, analysis is required to support the design and a Design Exception is required if minimum stopping sight distance cannot be achieved.**

When reviewing intersection sight distance, items such as building clearances, street appurtenances, potential sound walls, landscaping, on-street parking and other roadway elements must be taken into consideration in determining and obtaining the appropriate sight distance at intersections. Railroad and rail crossings are treated in the same manner as roadway intersections in determining intersection sight distance for the vehicle crossing the tracks. For placement of trees within the intersection sight distance triangle, see Part 300 and Part 400.

Pages 9-35 through 9-59 of the AASHTO Green Book indicate intersection sight distance for traffic turning left, crossing, or turning right onto a major highway. It is desirable to obtain intersection sight distance at all intersections. However, stopping sight distance is the minimum requirement.

217.5 Passing Sight Distance

Passing sight distance is the minimum distance required for a vehicle to safely and comfortably pass another vehicle. An assumption made for passing sight distance includes the passing vehicle accelerating to a speed of 10 mph above the vehicle being passed and the oncoming vehicle not reducing speed. A 3.5 foot height of eye of the passing vehicle and 3.5 foot height of object are used for measuring passing sight distance. If adequate passing sight distance opportunities cannot be accommodated in the project design, passing lanes or climbing lanes are desirable. Work with the Region Traffic Engineer on locations for passing opportunities, or passing or climbing lanes. Pages 3-10 thru 3-17 of the AASHTO Green Book provide more information on passing sight distance.

Section 218 Horizontal Alignment

218.1 General

The horizontal alignment of a highway affects vehicle operating speeds, sight distances, passing opportunities and highway capacities. Decisions on alignment also have a major impact on the cost of a project. *To provide a consistent alignment, avoid sudden changes from tangents and gentle curves to sharp curves.*

Check the combination of horizontal alignment and sight obstructions. Analyze horizontal curves through cut areas, through tunnels, and at intersections with minimum building setbacks to verify that stopping and intersection sight distances are met. Figure 200-17 provides design speed, stopping sight distance, and line of sight requirements for horizontal curves.

218.2 Urban Non-Freeway Horizontal Alignment

Controlling vehicle speed in urban corridors is important when balancing project design for all road users. The six ODOT urban contexts each have a defined target speed range appropriate for project design goals. One aspect in project design that aids in controlling vehicle speed is the roadway alignment. In new construction and to some degree in roadway reconstruction, the designer has control of potential alignment options and decisions that affect potential speed profiles. However, since much of ODOT's urban design work is along established corridors, alignments have already been established with existing built environments surrounding them. When corridor alignments were originally established, the areas may have been more rural in context, but over time, the adjacent properties redeveloped and the roadside context changed. In these locations, designers often have limited ability to make significant, if any, changes to the

existing alignment and alternative methods of speed control are applied to achieve the desired target speed. Potential options for traffic calming could include reallocation of roadway space or roadside features, roundabouts, possible reduction of travel lane widths or changes to roadway lane configuration, as well as installing urban features to the roadside to indicate to drivers they are in an urban context. These features could include curb and sidewalk, if non-existent, street trees where appropriate, raised medians, on-street parking where applicable, improved pedestrian crossings, and bicycle facilities.

218.3 3R Freeway Horizontal Curvature and Superelevation

Horizontal alignment, superelevation, and superelevation transition shall meet the minimum standards outlined in the AASHTO Green Book. Existing non-spiraled alignments are allowed as long as AASHTO transition design control requirements (tangent-to-curve transition) are met. ODOT 4R standards are to be used for horizontal and vertical curve corrections.

Because of terrain and high design speeds, rural freeways should have very gentle horizontal and vertical alignments. In rural areas, the designer should be able to create a safe and efficient facility while taking into consideration the aesthetic potential of the freeway and surrounding terrain. Most freeways are constructed near ground level and the designer should take advantage of the existing topography to create not only a functional freeway, but also one that looks and drives well and fits into the existing topography.

218.4 3R Rural Arterial Horizontal Curvature and Superelevation

Alignment improvements to horizontal curvature and superelevation can be as cost effective as lane and shoulder width improvements. *Evaluate reconstruction of the horizontal alignment, including spirals and superelevation development, when the comfort speed of the existing curvature is more than 15 mph below the project design speed, and the current year ADT is 2000 or greater. Refer to Section 218.7 for comfort speed. Also, include and consider curves in series along a roadway section in this analysis. Adjust these curves as necessary to provide consistency in alignment and drivability.* When reconstruction of the horizontal alignment is not justified, apply appropriate mitigation measures such as those listed in Part 300, Section 311. *Correction of the superelevation should be applied if the comfort speed of the curve is lower than the project design speed. If the comfort speed exceeds the project design speed, maintain the superelevation unless there is a justifiable reason to change it.*

218.5 3R Urban Arterial Horizontal Curvature and Superelevation

Each horizontal curve should be evaluated for design sufficiency compared to the ODOT Urban Standards. Deficient curves should be evaluated against criteria below to determine what level of corrective action, if any, is appropriate.

Evaluate reconstruction of horizontal curvature, including spirals and superelevation development, when the comfort speed of the existing curve is more than 15 mph below the project design speed, and the current year ADT is 2000 or greater. Refer to Section 218.7 for comfort speed. Also, include and consider curves in series along a roadway section. Adjust as necessary to provide consistency in alignment and drivability. When curve reconstruction is not justified, appropriate mitigation measures such as those listed in Part 300, Section 312 should be applied. Correction of the superelevation should be applied if the comfort speed of the curve is lower than the project design speed. If the comfort speed exceeds the project design speed, the superelevation should be maintained unless there is a justifiable reason to change it.

218.6 4R Horizontal Curvature (All Highways)

This section focuses on horizontal curvature. Vertical curvature is discussed in later sections. However, horizontal and vertical alignments must coordinate to provide effective, comfortable and aesthetic roadways. Refer to Section 220 for discussion of combined horizontal and vertical alignment and Figure 200-54 for examples of good and weak coordination of horizontal and vertical curves.

Horizontal curve calculations are based on the arc definition for a circular curve. Minimum degree of curvature can be found in Table 200-11 (Open Road), Table 200-12 (Urban) and Table 200-13 (Suburban). **Sufficient curve length must be used to prevent the appearance of a "kink" in the alignment. For small deflection angles, a minimum arc length of 15 times the design speed is required. For larger deflection angles where spiral transitions are required, the minimum arc length of the simple curve is 50 ft. An angle point is considered a curve with an arc length of zero, and therefore, does not meet the minimum standard.**

Compound curves are adjoining curves in the same direction with differing degrees of curvature. *They may be used where necessary with an intermediate spiral segment. Design the spiral segment to provide an "a" value equal to or less than the standard spiral for the sharper curve.* See Part 600 for spiral segments. The "a" value is a measure of the rate of change of the curvature. (Change in Degree of curve x 100 / length of spiral).

Broken back curves are curves in the same direction connected with a short segment of tangent. *It is desirable to avoid the use of broken back curves. When the use of a broken back alignment cannot be*

avoided, design the tangent section so that all travel lanes slope in the same direction as the superelevation of the curves. This avoids the introduction of two flat spots on the travel lane toward the outside of the curves and prevents the development of a dip on the edge of the pavement that can affect driver comfort and drainage (See Figure 200-19). Generally, this treatment is required when the length of the tangent is 500 feet or less.

Figure 200-17: SSD on Horizontal Curves

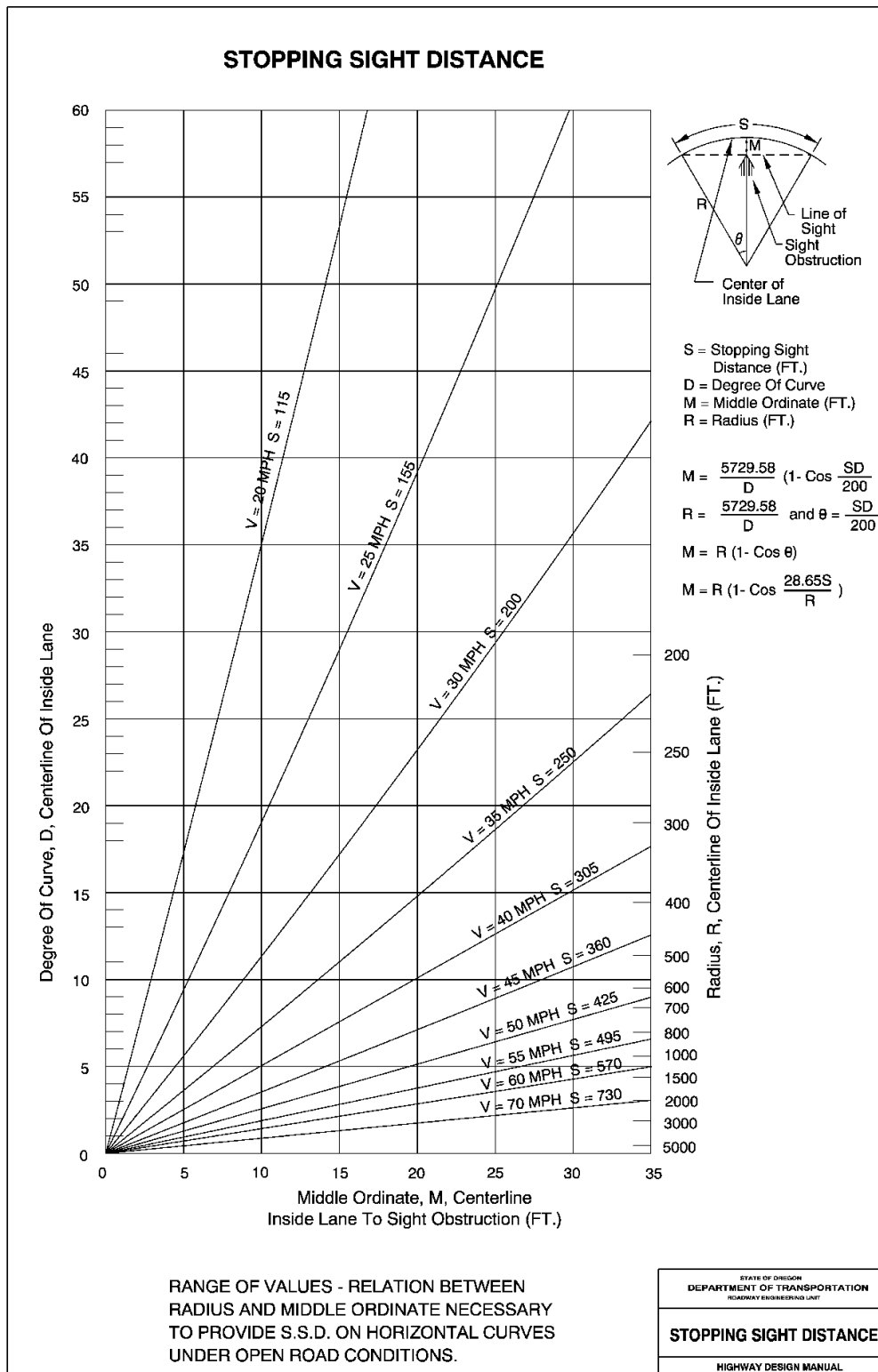

218.6.1 Spiral Transitions

Spirals provide a transition between tangents and curves and between circular curves of substantially different degrees of curve (spiral segment). The natural path of a vehicle entering a curve is to drive a spiral. Spirals also provide a location for developing superelevation. Standard spiral lengths are based on the number of lanes being rotated and the super rate for the curve. **Apply spirals to all curves of 1° or sharper. This applies to secondary as well as to primary highways. Curves with a degree of curve flatter than 1° are not required to be spiraled.** It is recommended that spirals be used for curves with a degree of curve flatter than 1° to assist in developing the superelevation runoff. When designing an unspiraled curve, refer to Figure 200-20. Longer spirals than the standard may be used wherever advantage in their use is apparent. Many existing alignments on the highway system include longer than standard spirals and operate very well. *Consider using longer spirals appropriate for a section with additional lanes when future widening is anticipated.* The standard spiral lengths for typical design speeds in open road, urban, and suburban settings are presented in Table 200-11, Table 200-12, and Table 200-13. The minimum spiral length for any curve not covered by these tables can be calculated using the three formulas also presented on Table 200-11, Table 200-12, and Table 200-13. Note that the spiral lengths presented in the tables are based on the formulas and then adjusted to provide a consistent progression in the “a” value. The “a” value is a measure of the rate of change of the curvature. (Change in Degree of curve x 100 / length of spiral). This results in a consistent feel for the driver. Spiral lengths are normally rounded up to the nearest 5 feet.

Design exceptions are required when using spirals that are less than standard. Using longer spirals than standard does not require an exception. Using unequal spiral lengths is not an exception if both meet or exceed standards. This arrangement is most commonly found on ramps. Designers always need to consider potential operational effects and the roadway context in making alignment decisions.

Prior versions of design standards were based on using inside edge super rotation. Current standards allow for using other rotation points when developing superelevation.

Ramp profile grades are typically carried at the ramp alignment and rotated about the ramp centerline.

*It's common for ramp alignments in the "terminal area" (where the ramp meets the crossroad) to have a spiral on one end only. The portion of the curve closest to the crossroad typically has to have reduced or no super in order to get intersection grades to work. A spiraled alignment in this situation isn't usually too beneficial. See Part 600 for additional information. **An exception is not required for this situation.***

The minimum length of the simple curve between spirals is 50 feet. *At times it may be appropriate to install a spiral segment to transition from one central curve to another central curve. These are called compound curves. The spiral segment assists in providing a smooth transition between two curves in close proximity to each other. **Back to back spirals between reversing curves are permissible.***

The type and location of the facility (urban or rural in nature) will dictate the proper combination of curve, spiral, and superelevation rate.

*On some low speed non-superelevated roadways, the use of spirals may not be warranted. In addressing the six urban contexts for urban arterials, the lack of spirals and/or reduced superelevation rate or the use of a crown section may be warranted in these environments to provide design flexibility in relation to urban context. **Smooth curvature is still required and angle points require an approved design exception.*** In some narrow lane locations where spiral transition is not provided, widening of the outside shoulder may be of benefit for smoother curve transition for drivers. **Designing such roadways without spirals and standard superelevation requires a design exception.**

218.6.2 Superelevation and Methods for Developing Superelevation

The standard method of developing superelevation runoff is shown in Figure 200-20 and Figure 200-22. *The standard method of superelevation development for ODOT is rotation around the profile grade. The profile grade is normally carried along the centerline or the low side edge of travel.* Other options as shown in Figure 200-21 are also available. Where the grade is 4 percent or greater, the superelevation is developed according to Section 221. *When the superelevation is rotated about centerline, ensure the design doesn't create a low spot on the inside of the curve where ponding can occur. For flat curves with a degree of curve less than $0^{\circ} 30'$ superelevation is typically not required.* In the design of runoff, the use of multiple line profiles is suggested. Multiple line profiles are especially useful in situations where grade controls at road approaches, building elevations or interchange designs are encountered.

When a horizontal curve has less than 200 feet of main circular curve, the superelevation along the main curve is determined by joining the runoffs in the center of the curve and using a continuous vertical curve of a length equal to twice the length of the main curve, with a minimum vertical curve length of 200 feet.

On multi-lane divided highways, each direction may have an independent alignment. In these situations, the superelevation for one direction may be developed independent of the other to minimize run-out lengths. Each direction follows the superelevation rules contained in this section for the number of lanes on each alignment.

When the tangent distance between reversing curves is less than 400 feet, adjust the runoff of the superelevation so that the edges of pavement and the centerline fall on a uniform grade between the Point of Curve to Spiral (PCS) of the first curve and the Point of Spiral to Curve (PSC) of the second curve. (See Figure 200-20).

Standard superelevation applies on climbing lanes, when climatic conditions warrant it. A design exception for reduced superelevation may be granted for a climbing lane on the high side of a curve.

Use Table 200-11 to determine proper superelevation and spiral lengths for freeways and rural highways. For design speed other than shown, determine the superelevation by interpolation and calculate the spiral length. This table is also used for constrained rural mountainous locations.

Table 200-11 also applies to freeways and rural areas where snow and ice conditions prevail. Elevations over 3000 feet can be considered where snow and ice prevail. Other locations, such as the Columbia River Gorge may be considered for discussion as a snow and ice area. In these areas, avoid using a degree of curve that would normally be designed with a superelevation greater than 8 percent. For example, if the design speed is 70 mph, the maximum degree of curve where snow and ice prevail would be 3 degrees. If a sharper curvature must be used, the superelevation may be held at 8 percent with the understanding that the curve would have a “comfort speed” lower than the design speed and may need to be posted with a speed rider. In this situation, the comfort speed table (Table 200-14) can be used to determine the comfort speed of any curve at 8 percent superelevation.

Limiting the superelevation to 8 percent on roadways where snow and ice prevail when standard superelevation would normally be greater than 8 percent requires a design exception. It is generally not appropriate to limit the superelevation to anything less than 8 percent on a rural highway as that may compromise safety and operations during warmer times of the year.

Use Table 200-12 for ODOT urban context locations where design speeds range from 25-40 mph and the maximum superelevation rate is 4 percent. Use the suburban superelevation and spiral lengths table (Table 200-13) for transition areas between urban/suburban and rural areas and design speeds range from 45-55 mph, with a maximum superelevation rate of 6 percent. This table may also be appropriate for the suburban fringe context and also rural community context where design speeds range from 45-55 mph.

Table 200-11: Open Road Superelevation & Spiral Lengths

D	R	70 mph								60 MPH								50 MPH								D			
		e	L1	L2	L3	L4	L5	L6	L7	L8	e	L1	L2	L3	L4	L5	L6	L7	L8	e	L1	L2	L3	L4	L5		L6	L7	L8
0°30'	11459.16	2.0	-	-	-	-	-	-	-	NC	-	-	-	-	-	-	-	-	-	NC	-	-	-	-	-	-	-	-	0°30'
0°35'	9822.13	2.0	-	-	-	-	-	-	-	2.0	-	-	-	-	-	-	-	-	-	2.0	-	-	-	-	-	-	-	-	0°35'
0°40'	8594.37	2.5	-	-	-	-	-	-	-	2.0	-	-	-	-	-	-	-	-	-	NC	-	-	-	-	-	-	-	-	0°40'
0°45'	7639.44	3.0	-	-	-	-	-	-	-	2.0	-	-	-	-	-	-	-	-	-	NC	-	-	-	-	-	-	-	-	0°45'
0°50'	6875.49	3.0	-	-	-	-	-	-	-	2.5	-	-	-	-	-	-	-	-	-	2.0	-	-	-	-	-	-	-	-	0°50'
0°55'	6250.45	3.5	-	-	-	-	-	-	-	2.5	-	-	-	-	-	-	-	-	-	2.0	-	-	-	-	-	-	-	-	0°55'
1°00'	5729.58	3.5	205	310	410	515	615	720	820	925	3.0	175	265	350	440	525	615	700	790	2.0	145	220	290	365	435	510	580	655	1°00'
1°05'	5288.84	4.0	205	310	410	515	615	720	820	925	3.0	175	265	350	440	525	615	700	790	2.5	145	220	290	365	435	510	580	655	1°05'
1°10'	4911.07	4.0	205	310	410	515	615	720	820	925	3.5	175	265	350	440	525	615	700	790	2.5	145	220	290	365	435	510	580	655	1°10'
1°15'	4583.66	4.5	205	310	410	515	615	720	820	925	3.5	175	265	350	440	525	615	700	790	2.5	145	220	290	365	435	510	580	655	1°15'
1°20'	4297.18	4.5	205	310	410	515	615	720	820	925	4.0	175	265	350	440	525	615	700	790	3.0	145	220	290	365	435	510	580	655	1°20'
1°25'	4044.41	5.0	205	310	410	515	615	720	820	925	4.0	175	265	350	440	525	615	700	790	3.0	145	220	290	365	435	510	580	655	1°25'
1°30'	3819.72	5.0	205	310	410	515	615	720	820	925	4.0	175	265	350	440	525	615	700	790	3.0	145	220	290	365	435	510	580	655	1°30'
1°35'	3618.68	5.5	205	310	410	515	615	720	820	925	4.5	175	265	350	440	525	615	700	790	3.5	145	220	290	365	435	510	580	655	1°35'
1°40'	3437.75	5.5	205	310	410	515	615	720	820	925	4.5	175	265	350	440	525	615	700	790	3.5	145	220	290	365	435	510	580	655	1°40'
1°45'	3274.04	6.0	205	310	410	515	615	720	820	925	5.0	175	265	350	440	525	615	700	790	3.5	145	220	290	365	435	510	580	655	1°45'
1°50'	3125.22	6.0	205	310	410	515	615	720	820	925	5.0	175	265	350	440	525	615	700	790	4.0	145	220	290	365	435	510	580	655	1°50'
1°55'	2989.35	6.5	205	310	410	515	615	720	820	925	5.0	175	265	350	440	525	615	700	790	4.0	145	220	290	365	435	510	580	655	1°55'
2°00'	2864.79	6.5	205	310	410	515	615	720	820	925	5.5	175	265	350	440	525	615	700	790	4.0	145	220	290	365	435	510	580	655	2°00'
2°10'	2644.42	7.0	215	325	430	540	645	755	860	970	6.0	175	265	350	440	525	615	700	790	4.5	145	220	290	365	435	510	580	655	2°10'
2°15'	2546.48	7.0	220	330	440	550	660	770	880	990	6.0	175	265	350	440	525	615	700	790	4.5	145	220	290	365	435	510	580	655	2°15'
2°20'	2455.53	7.5	225	340	450	565	675	790	900	1015	6.0	175	265	350	440	525	615	700	790	4.5	145	220	290	365	435	510	580	655	2°20'
2°30'	2291.83	7.5	225	340	450	565	675	790	900	1015	6.5	175	265	350	440	525	615	700	790	5.0	150	225	300	375	450	525	600	675	2°30'
2°45'	2083.48	8.0	240	360	480	600	720	840	960	1080	7.0	190	285	380	475	570	665	760	855	5.5	165	250	330	415	495	580	660	745	2°45'
3°00'	1909.86	8.0	250	375	500	625	750	875	1000	1125	7.5	205	310	410	515	615	720	820	925	6.0	180	270	360	450	540	630	720	810	3°00'
3°15'	1762.95	8.5	255	385	510	640	765	895	1020	1150	8.0	220	330	440	550	660	770	880	990	6.0	195	295	390	490	585	685	780	880	3°15'
3°30'	1637.02	9.0	270	405	540	675	810	945	1080	1215	8.0	220	330	440	550	660	770	880	990	6.5	210	315	420	525	630	735	840	945	3°30'
3°45'	1527.89	9.0	285	430	570	715	855	1000	1140	1285	8.0	225	340	450	565	675	790	900	1015	7.0	210	315	420	525	630	735	840	945	3°45'
4°00'	1432.39	9.0	300	450	600	750	900	1050	1200	1350	8.5	230	345	460	575	690	805	920	1035	7.5	210	315	420	525	630	735	840	945	4°00'
4°15'	1348.14	9.5	300	450	600	750	900	1050	1200	1350	8.5	230	345	460	575	690	805	920	1035	7.5	215	325	430	540	645	755	860	970	4°15'
4°30'	1273.24	9.5	300	450	600	750	900	1050	1200	1350	9.0	240	360	480	600	720	840	960	1080	8.0	220	330	440	550	660	770	880	990	4°30'
4°45'	1206.23	9.5	300	450	600	750	900	1050	1200	1350	9.0	245	370	490	615	735	860	980	1105	8.0	220	330	440	550	660	770	880	990	4°45'
5°00'	1145.92	9.5	300	450	600	750	900	1050	1200	1350	9.5	255	385	510	640	765	895	1020	1150	8.5	230	345	460	575	690	805	920	1035	5°00'
5°15'	1091.35	10.0	300	450	600	750	900	1050	1200	1350	10.0	300	450	600	750	900	1050	1200	1350	8.5	230	345	460	575	690	805	920	1035	5°15'
5°30'	1041.74	10.0	300	450	600	750	900	1050	1200	1350	10.0	300	450	600	750	900	1050	1200	1350	8.5	230	345	460	575	690	805	920	1035	5°30'
5°45'	996.45	10.0	300	450	600	750	900	1050	1200	1350	10.0	300	450	600	750	900	1050	1200	1350	9.0	230	345	460	575	690	805	920	1035	5°45'
6°00'	954.93	10.0	300	450	600	750	900	1050	1200	1350	10.0	300	450	600	750	900	1050	1200	1350	9.0	240	360	480	600	720	840	960	1080	6°00'
6°15'	916.73	10.0	300	450	600	750	900	1050	1200	1350	10.0	300	450	600	750	900	1050	1200	1350	9.0	245	370	490	615	735	860	980	1105	6°15'
6°30'	881.47	10.0	300	450	600	750	900	1050	1200	1350	10.0	300	450	600	750	900	1050	1200	1350	9.5	250	375	500	625	750	875	1000	1125	6°30'
6°45'	848.83	10.5	285	430	570	715	855	1000	1140	1285	10.5	285	430	570	715	855	1000	1140	1285	9.5	255	385	510	640	765	895	1020	1150	6°45'
7°00'	818.51	10.5	285	430	570	715	855	1000	1140	1285	10.5	285	430	570	715	855	1000	1140	1285	9.5	260	390	520	650	780	910	1040	1170	7°00'
7°15'	790.29	10.5	285	430	570	715	855	1000	1140	1285	10.5	285	430	570	715	855	1000	1140	1285	10.0	265	400	530	665	795	930	1060	1195	7°15'
7°30'	763.94	10.5	285	430	570	715	855	1000	1140	1285	10.5	285	430	570	715	855	1000	1140	1285	10.0	270	405	540	675	810	945	1080	1215	7°30'
8°00'	716.20	10.																											

Table 200-12: Urban Superelevation & Spiral Lengths

D	40					35					30					25					D				
	e	L1	L2	L3	L4	L5	e	L1	L2	L3	L4	L5	e	L1	L2	L3	L4	L5	e	L1		L2	L3	L4	L5
1°00'	NC	-	-	-	-	-	NC	-	-	-	-	-	NC	-	-	-	-	-	NC	-	-	-	-	-	1°00'
1°15'	NC	-	-	-	-	-	NC	-	-	-	-	-	NC	-	-	-	-	-	NC	-	-	-	-	-	1°15'
1°30'	2	120	180	240	300	360	NC	-	-	-	-	-	NC	-	-	-	-	-	NC	-	-	-	-	-	1°30'
1°45'	2	120	180	240	300	360	NC	-	-	-	-	-	NC	-	-	-	-	-	NC	-	-	-	-	-	1°45'
2°00'	2	120	180	240	300	360	2	105	160	210	265	315	NC	-	-	-	-	-	NC	-	-	-	-	-	2°00'
2°15'	2.5	120	180	240	300	360	2	105	160	210	265	315	NC	-	-	-	-	-	NC	-	-	-	-	-	2°15'
2°30'	2.5	130	195	260	325	390	2	105	160	210	265	315	NC	-	-	-	-	-	NC	-	-	-	-	-	2°30'
2°45'	2.5	140	210	280	350	420	2	105	160	210	265	315	NC	-	-	-	-	-	NC	-	-	-	-	-	2°45'
3°00'	2.5	120	180	240	300	360	2.5	105	160	210	265	315	2	90	135	180	225	270	NC	-	-	-	-	-	3°00'
3°15'	2.5	120	180	240	300	360	2.5	105	160	210	265	315	2	90	135	180	225	270	NC	-	-	-	-	-	3°15'
3°30'	2.5	120	180	240	300	360	2.5	105	160	210	265	315	2	75	115	150	190	225	2	75	115	150	190	225	3°30'
3°45'	2.5	120	180	240	300	360	2.5	105	160	210	265	315	2.5	75	115	150	190	225	2	75	115	150	190	225	3°45'
4°00'	2.5	120	180	240	300	360	2.5	105	160	210	265	315	2.5	90	135	180	225	270	2	75	115	150	190	225	4°00'
4°15'	3	120	180	240	300	360	2.5	105	160	210	265	315	2.5	90	135	180	225	270	2	75	115	150	190	225	4°15'
4°30'	3	120	180	240	300	360	2.5	105	160	210	265	315	2.5	90	135	180	225	270	2	75	115	150	190	225	4°30'
4°45'	3	120	180	240	300	360	2.5	105	160	210	265	315	2.5	90	135	180	225	270	2	75	115	150	190	225	4°45'
5°00'	3	120	180	240	300	360	2.5	105	160	210	265	315	2.5	90	135	180	225	270	2	75	115	150	190	225	5°00'
5°15'	3	120	180	240	300	360	2.5	105	160	210	265	315	2.5	90	135	180	225	270	2	75	115	150	190	225	5°15'
5°30'	3	120	180	240	300	360	2.5	105	160	210	265	315	2.5	90	135	180	225	270	2.5	75	115	150	190	225	5°30'
5°45'	3	125	190	250	315	375	2.5	105	160	210	265	315	2.5	90	135	180	225	270	2.5	75	115	150	190	225	5°45'
6°00'	3	130	195	260	325	390	3	105	160	210	265	315	2.5	90	135	180	225	270	2.5	75	115	150	190	225	6°00'
6°15'	3	135	205	270	340	405	3	105	160	210	265	315	2.5	90	135	180	225	270	2.5	75	115	150	190	225	6°15'
6°30'	3	140	210	280	350	420	3	105	160	210	265	315	2.5	90	135	180	225	270	2.5	75	115	150	190	225	6°30'
7°00'	3.5	140	210	280	350	420	3	105	160	210	265	315	2.5	90	135	180	225	270	2.5	75	115	150	190	225	7°00'
7°30'	3.5	150	225	300	375	450	3	105	160	210	265	315	2.5	90	135	180	225	270	2.5	75	115	150	190	225	7°30'
8°00'	3.5	160	240	320	400	480	3	105	160	210	265	315	2.5	90	135	180	225	270	2.5	80	120	160	200	240	8°00'
8°30'	3.5	165	250	330	415	495	3	110	165	220	275	330	3	90	135	180	225	270	2.5	85	130	170	215	255	8°30'
9°00'	4	170	255	340	425	510	3	115	175	230	290	345	3	90	135	180	225	270	2.5	90	135	180	225	270	9°00'
9°30'	4	175	265	350	440	525	3	120	180	240	300	360	3	95	145	190	240	285	2.5	95	145	190	240	285	9°30'
10°00'	4	180	270	360	450	540	3.5	125	190	250	315	375	3	100	150	200	250	300	2.5	100	150	200	250	300	10°00'
10°30'							3.5	130	195	260	325	390	3	105	160	210	265	315	2.5	105	160	210	265	315	10°30'
11°00'							3.5	135	205	270	340	405	3	105	160	210	265	315	2.5	105	160	210	265	315	11°00'
11°30'							3.5	140	210	280	350	420	3	110	165	220	275	330	2.5	105	160	210	265	315	11°30'
12°00'							3.5	145	220	290	365	435	3	110	165	220	275	330	2.5	105	160	210	265	315	12°00'
12°30'							3.5	150	225	300	375	450	3	115	175	230	290	345	2.5	105	160	210	265	315	12°30'
13°00'							3.5	155	235	310	390	465	3	115	175	230	290	345	2.5	105	160	210	265	315	13°00'
13°30'							3.5	160	240	320	400	480	3	120	180	240	300	360	2.5	105	160	210	265	315	13°30'
14°00'							4	165	250	330	415	495	3	120	180	240	300	360	3	105	160	210	265	315	14°00'
15°00'							4	175	265	350	440	525	3.5	125	190	250	315	375	3	105	160	210	265	315	15°00'
16°00'													3.5	130	195	260	325	390	3	105	160	210	265	315	16°00'
17°00'													3.5	135	205	270	340	405	3	105	160	210	265	315	17°00'
18°00'													3.5	140	210	280	350	420	3	105	160	210	265	315	18°00'
19°00'													3.5	145	220	290	365	435	3	105	160	210	265	315	19°00'
20°00'													3.5	150	225	300	375	450	3	105	160	210	265	315	20°00'
21°00'													4	160	240	320	400	480	3	105	160	210	265	315	21°00'
22°00'													4	165	250	330	415	495	3	110	165	220	275	330	22°00'
23°00'																			3	115	175	230	290	345	23°00'
24°00'																			3.5	120	180	240	300	360	24°00'
25°00'																			3.5	120	180	240	300	360	25°00'
26°00'																			3.5	120	180	240	300	360	26°00'
27°00'																			3.5	120	180	240	300	360	27°00'
28°00'																			3.5	120	180	240	300	360	28°00'
29°00'																			3.5	125	190	250	315	375	29°00'
30°00'																			3.5	130	195	260	325	390	30°00'
32°00'																			3.5	150	225	300	375	450	32°00'
34°00'																			4	155	235	310	390	465	34°00'
36°00'																			4	155	235	310	390	465	36°00'

When standard length spirals cannot be attained, use the formulas below for minimum spiral lengths by runoff, comfort, & aesthetics.
Use the longest spiral solution of the three and round to the nearest higher even 5 feet.

Superelevation Runoff:
Ln = [(w * n * e) / s] * b; b = [1 + 0.5 * (n-1)] / n

Where: w = width of lane, typically 12 ft
Where: e = superelevation rate in percent
Where: n = number of lanes rotated
Where: b = adjustment factor
Where: s = relative slope in percent
s = 0.70 @ 25 mph
s = 0.66 @ 30 mph
s = 0.62 @ 35 mph
s = 0.58 @ 40 mph
s = 0.54 @ 45 mph
s = 0.50 @ 50 mph
s = 0.47 @ 55 mph
s = 0.45 @ 60 mph
s = 0.43 @ 65 mph
s = 0.40 @ 70 mph

Centrifugal Control: Ls = (D)(V³/3538)
Where: V = velocity in mph and D = Degree of curve

Aesthetic Control: Ls = 2.9V
Where: V = velocity in mph

LEGEND:
NC - Normal crown
D - Degree of curve
e - Superelevation in percent
Ln - Standard spiral length for n lanes rotated,

Table 200-13: Suburban Superelevation & Spiral Lengths

D	55						50						45						D
	e	L1	L2	L3	L4	L5	e	L1	L2	L3	L4	L5	e	L1	L2	L3	L4	L5	
0°45'	2	160	240	320	400	480	NC	-	-	-	-	-	NC	-	-	-	-	-	0°45'
0°50'	2	160	240	320	400	480	NC	-	-	-	-	-	NC	-	-	-	-	-	0°50'
0°55'	2	160	240	320	400	480	2	145	220	290	365	435	NC	-	-	-	-	-	0°55'
1°00'	2.5	160	240	320	400	480	2	145	220	290	365	435	NC	-	-	-	-	-	1°00'
1°05'	2.5	160	240	320	400	480	2	145	220	290	365	435	2	135	205	270	340	405	1°05'
1°10'	2.5	160	240	320	400	480	2.5	145	220	290	365	435	2	135	205	270	340	405	1°10'
1°15'	3	160	240	320	400	480	2.5	145	220	290	365	435	2	135	205	270	340	405	1°15'
1°20'	3	160	240	320	400	480	2.5	145	220	290	365	435	2	135	205	270	340	405	1°20'
1°25'	3	160	240	320	400	480	2.5	145	220	290	365	435	2.5	135	205	270	340	405	1°25'
1°30'	3	160	240	320	400	480	3	145	220	290	365	435	2.5	135	205	270	340	405	1°30'
1°35'	3.5	160	240	320	400	480	3	145	220	290	365	435	2.5	135	205	270	340	405	1°35'
1°40'	3.5	160	240	320	400	480	3	145	220	290	365	435	2.5	135	205	270	340	405	1°40'
1°45'	3.5	160	240	320	400	480	3	145	220	290	365	435	2.5	135	205	270	340	405	1°45'
1°50'	3.5	160	240	320	400	480	3.5	145	220	290	365	435	3	135	205	270	340	405	1°50'
1°55'	4	160	240	320	400	480	3.5	145	220	290	365	435	3	135	205	270	340	405	1°55'
2°00'	4	160	240	320	400	480	3.5	145	220	290	365	435	3	135	205	270	340	405	2°00'
2°05'	4	160	240	320	400	480	3.5	145	220	290	365	435	3	135	205	270	340	405	2°05'
2°10'	4	160	240	320	400	480	3.5	145	220	290	365	435	3	135	205	270	340	405	2°10'
2°15'	4.5	160	240	320	400	480	4	145	220	290	365	435	3.5	135	205	270	340	405	2°15'
2°20'	4.5	160	240	320	400	480	4	145	220	290	365	435	3.5	135	205	270	340	405	2°20'
2°25'	4.5	160	240	320	400	480	4	145	220	290	365	435	3.5	135	205	270	340	405	2°25'
2°30'	4.5	160	240	320	400	480	4	145	220	290	365	435	3.5	135	205	270	340	405	2°30'
2°35'	4.5	160	240	320	400	480	4	145	220	290	365	435	3.5	135	205	270	340	405	2°35'
2°40'	4.5	160	240	320	400	480	4	145	220	290	365	435	3.5	135	205	270	340	405	2°40'
2°45'	4.5	160	240	320	400	480	4	145	220	290	365	435	3.5	135	205	270	340	405	2°45'
2°50'	4.5	160	240	320	400	480	4	145	220	290	365	435	4	135	205	270	340	405	2°50'
2°55'	4.5	160	240	320	400	480	4.5	145	220	290	365	435	4	135	205	270	340	405	2°55'
3°00'	4.5	160	240	320	400	480	4.5	145	220	290	365	435	4	135	205	270	340	405	3°00'
3°15'	5	165	250	330	415	495	4.5	145	220	290	365	435	4	135	205	270	340	405	3°15'
3°30'	5	170	255	340	425	510	4.5	145	220	290	365	435	4	135	205	270	340	405	3°30'
3°45'	5	180	270	360	450	540	4.5	150	225	300	375	450	4.5	135	205	270	340	405	3°45'
4°00'	5	190	285	380	475	570	4.5	160	240	320	400	480	4.5	135	205	270	340	405	4°00'
4°15'	5.5	200	300	400	500	600	5	170	255	340	425	510	4.5	135	205	270	340	405	4°15'
4°30'	5.5	210	315	420	525	630	5	180	270	360	450	540	4.5	135	205	270	340	405	4°30'
4°45'	5.5	220	330	440	550	660	5	190	285	380	475	570	4.5	135	205	270	340	405	4°45'
5°00'	6	230	345	460	575	690	5	195	295	390	490	585	4.5	140	210	280	350	420	5°00'
5°15'	6	240	360	480	600	720	5.5	200	300	400	500	600	5	145	220	290	365	435	5°15'
5°30'							5.5	205	310	410	515	615	5	150	225	300	375	450	5°30'
5°45'							5.5	210	315	420	525	630	5	155	235	310	390	465	5°45'
6°00'							5.5	215	325	430	540	645	5	160	240	320	400	480	6°00'
6°15'							5.5	220	330	440	550	660	5	165	250	330	415	495	6°15'
6°30'							6	225	340	450	565	675	5	170	255	340	425	510	6°30'
6°45'							6	230	345	460	575	690	5.5	175	265	350	440	525	6°45'
7°00'													5.5	180	270	360	450	540	7°00'
7°15'													5.5	185	280	370	465	555	7°15'
7°30'													5.5	190	285	380	475	570	7°30'
7°45'													5.5	195	295	390	490	585	7°45'
8°00'													6	200	300	400	500	600	8°00'

When standard length spirals cannot be attained, use the formulas below for minimum spiral lengths by runoff, comfort, & aesthetics. Use the longest spiral solution of the three and round to the nearest higher even 5 feet.

Superelevation Runoff:
 $L_n = [(w * n * e) / s] * b$; $b = [1 + 0.5 * (n-1)] / n$

- Where: w=width of lane; typically 12 ft
- Where: e=superelevation rate in percent
- Where: n=number of lanes rotated
- Where: b=adjustment factor
- Where: s=relative slope in percent
- s=0.70 @ 25 mph
- s=0.66 @ 30 mph
- s=0.62 @ 35 mph
- s=0.58 @ 40 mph
- s=0.54 @ 45 mph
- s=0.50 @ 50 mph
- s=0.47 @ 55 mph
- s=0.45 @ 60 mph
- s=0.43 @ 65 mph
- s=0.40 @ 70 mph

Centrifugal Control: $L_s = (D)(V^3/3638)$
 Where: V=velocity in mph and D= Degree of curve

Aesthetic Control: $L_s = 2.9V$
 Where: V=velocity in mph

LEGEND:
 NC - Normal crown
 D - Degree of curve
 e - Superelevation in percent
 L_n - Standard spiral length for n lanes rotated;

Figure 200-18: Standard Superelevation

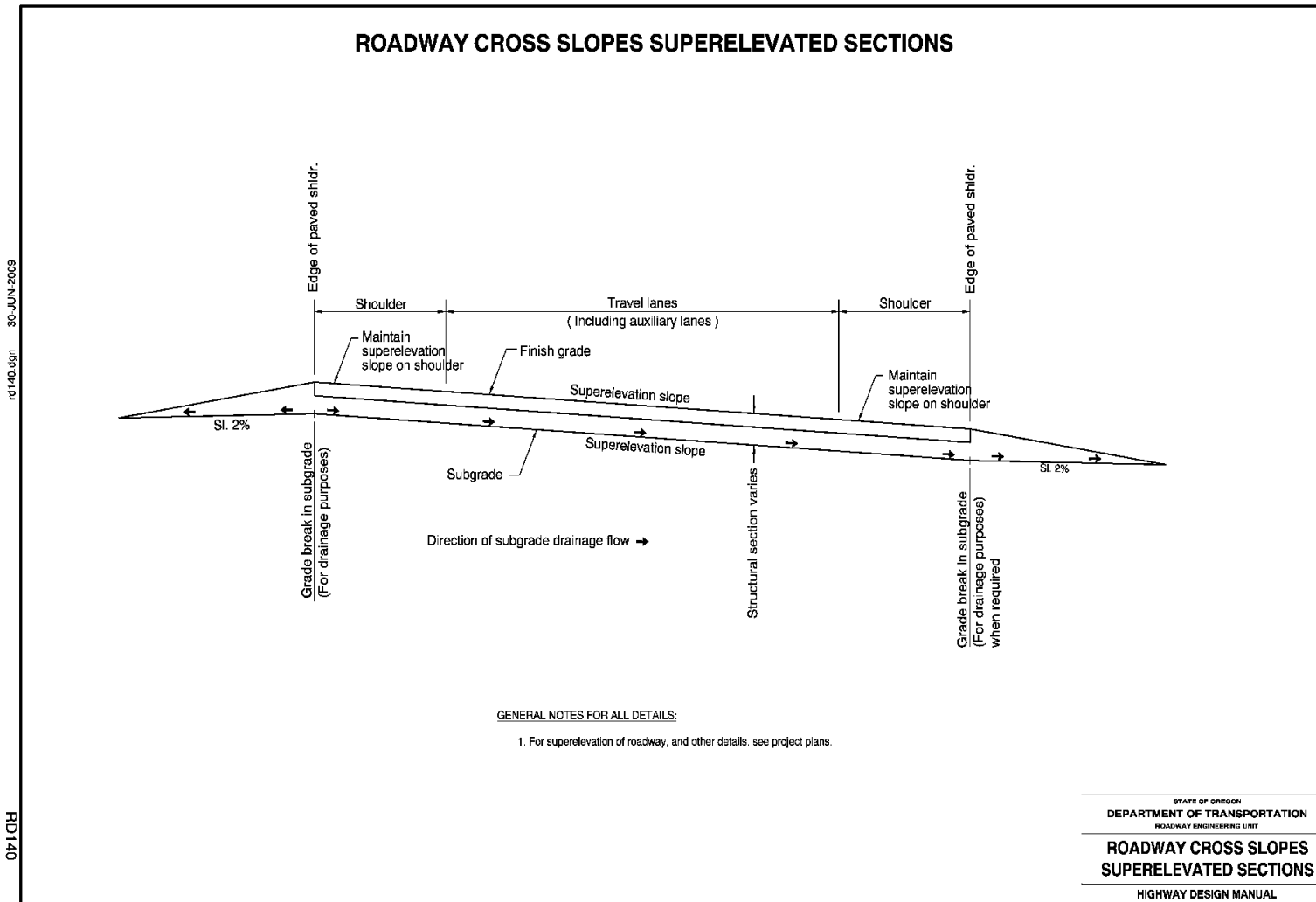

Figure 200-19: Developing Superelevation on 2-Lane Highways

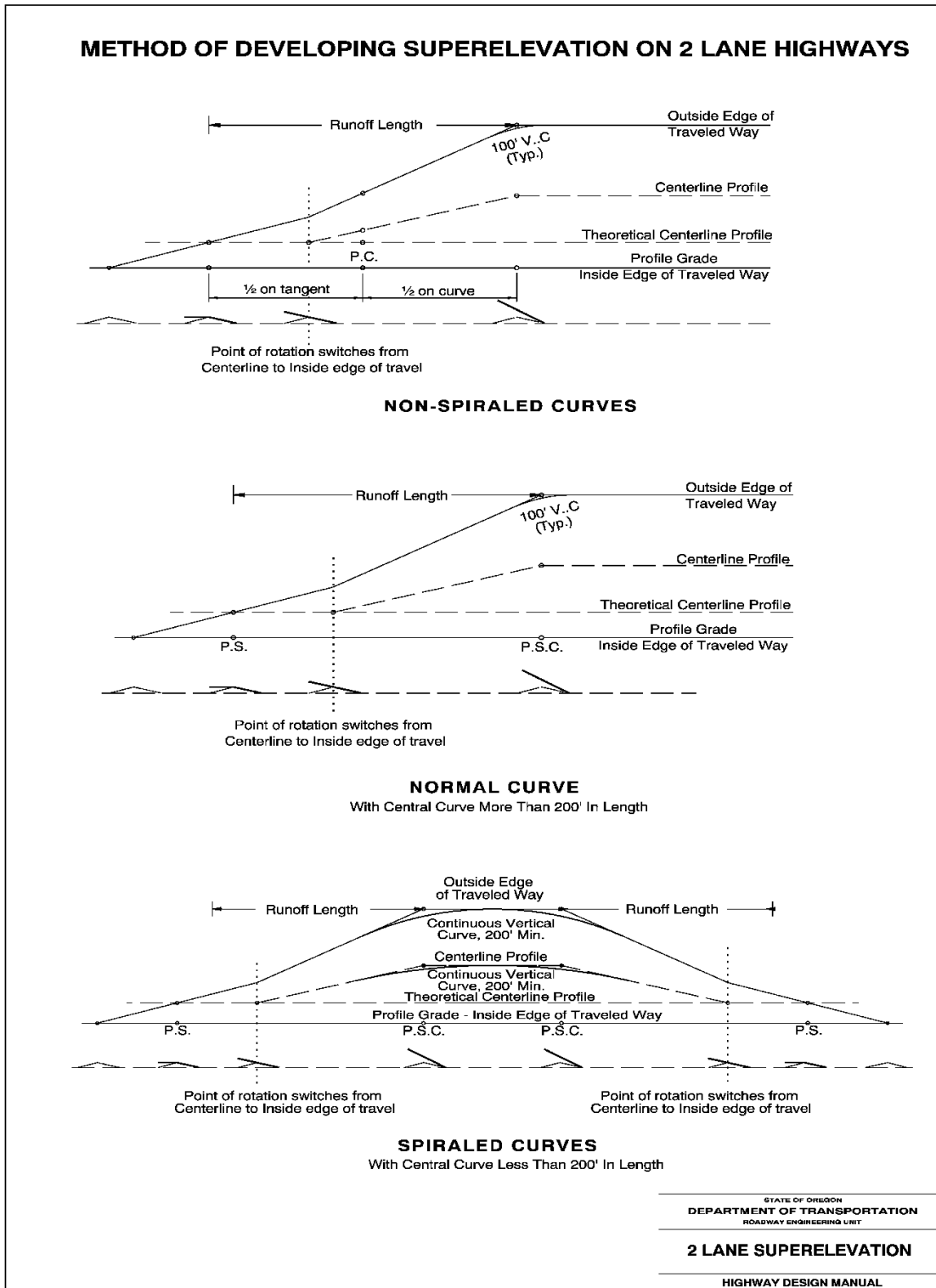

Figure 200-20: Developing Superelevation on 2-Lane Highways (Cont'd)

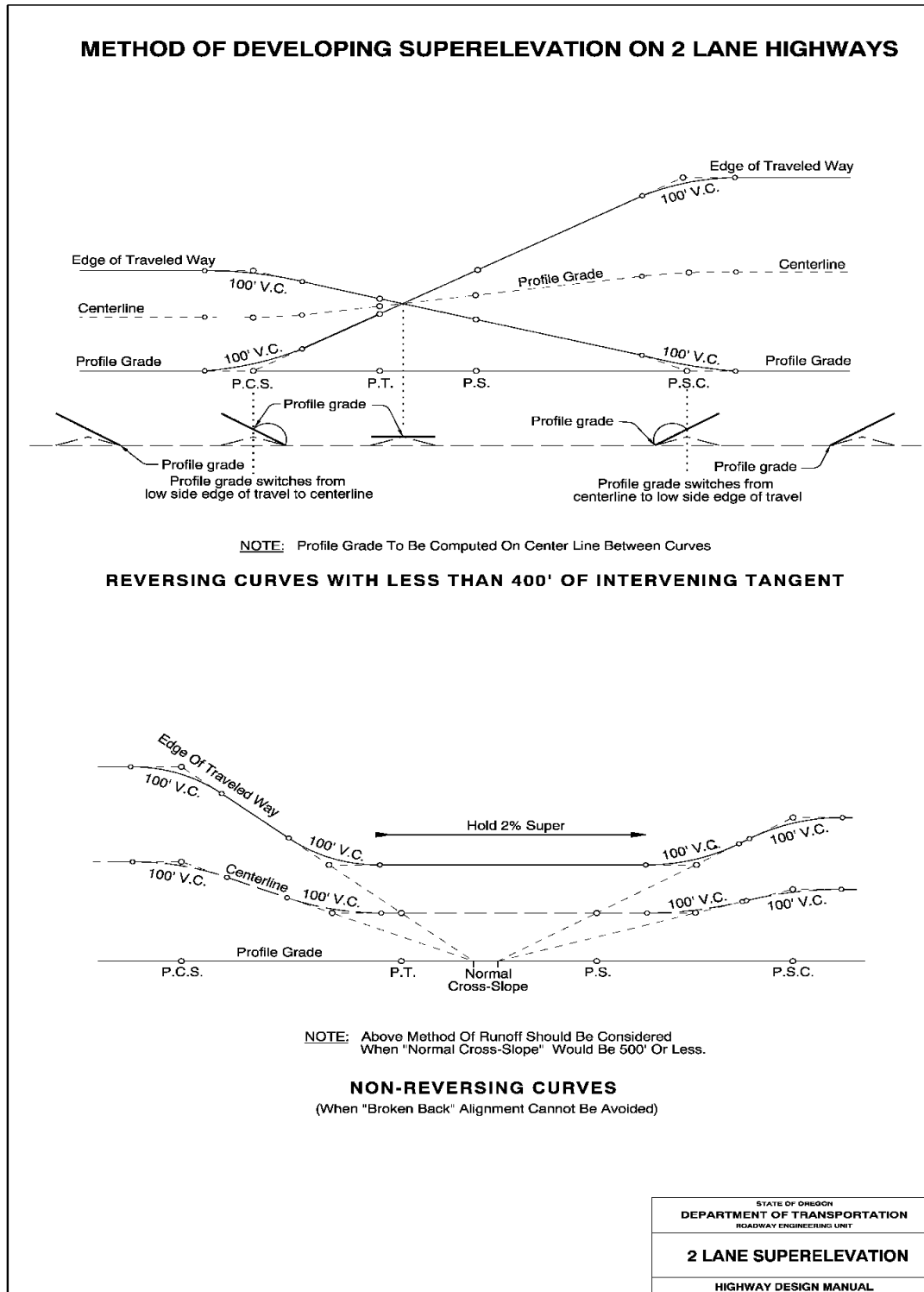

Figure 200-21: Examples of Additional Methods for Developing Superelevation

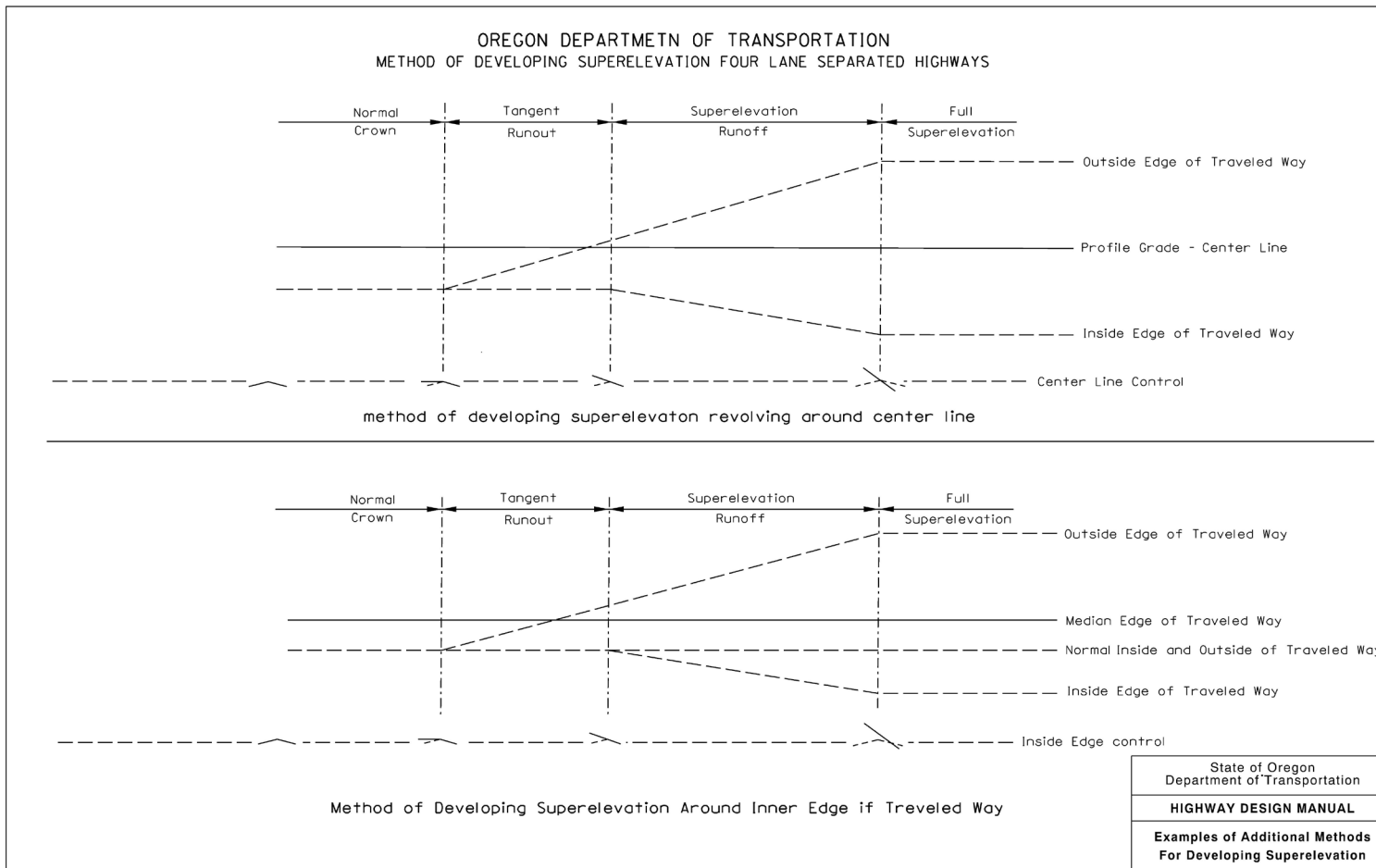
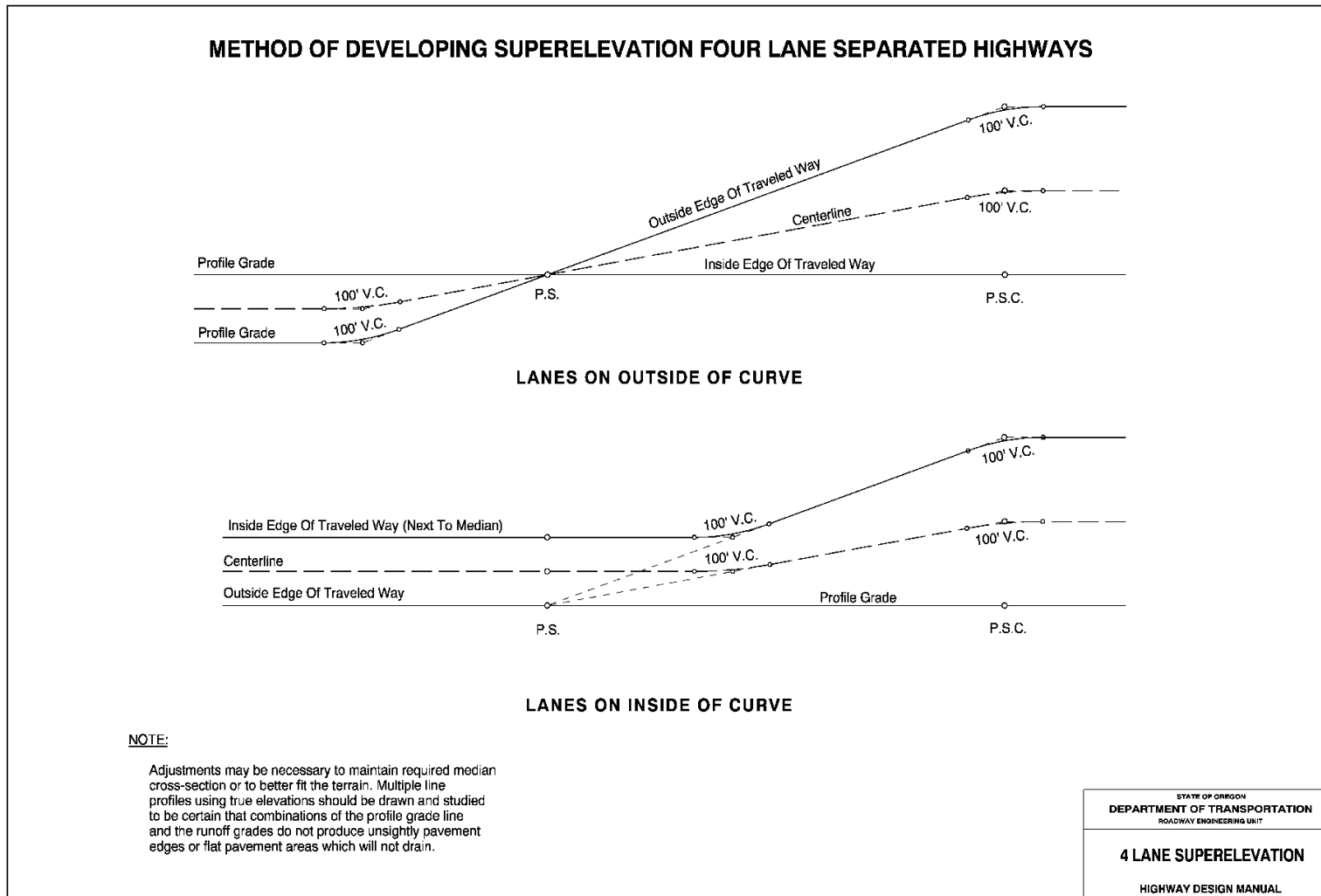

Figure 200-22: Developing Superelevation on 4-Lane Highways



218.7 Comfort Speed Chart

The Comfort Speed Chart shown in Table 200-14 represents the vehicle speed, degree of curvature and superelevation at the point where the driver begins to experience an unacceptable level of discomfort. The data in this chart does not represent a design standard. Design standards for superelevation are provided in Table 200-11, Table 200-12, and Table 200-13. *This chart is provided as a tool to evaluate existing or proposed sections for safety and operation. It can also be used for supporting data as part of a design exception.*

Table 200-14: Comfort Speed

Curve		Superelevation in Feet per Foot of Width																							
Degree	Radius (ft)	0.020	0.000	0.020	0.025	0.030	0.035	0.040	0.045	0.050	0.055	0.060	0.065	0.070	0.075	0.080	0.085	0.090	0.095	0.100	0.105	0.110	0.115	0.120	
0°30'	11459.16	87	94	100																					
0°45'	7639.44	81	86	92	93	95																			
1°00'	5729.58	76	81	86	87	88	90	91																	
1°15'	4583.66	72	76	81	82	83	84	86	87	88															
1°30'	3819.72	68	73	77	78	79	80	81	82	83															
1°45'	3274.04	65	70	74	75	76	77	78	78	79	80	81	82												
2°00'	2864.79	63	67	71	72	72	73	74	75	76	77	78	79	80											
2°15'	2546.48	61	64	68	69	70	71	72	72	73	74	75	76	77	77	78									
2°30'	2291.83	59	62	66	67	67	68	69	70	71	72	72	73	74	75	75	76								
2°45'	2083.48	57	60	64	64	65	66	67	68	68	69	70	71	72	72	73	74								
3°00'	1909.86	55	59	62	63	63	64	65	66	66	67	68	69	69	70	71	72								
3°15'	1762.95	54	57	60	61	62	62	63	64	65	65	66	67	67	68	69	69	70							
3°30'	1637.02	52	56	59	59	60	61	61	62	63	64	64	65	66	66	67	68	68							
3°45'	1527.89	51	54	57	58	59	59	60	61	61	62	63	63	64	65	65	66	67							
4°00'	1432.39	50	53	56	56	57	58	58	59	60	60	61	62	62	63	64	64	65							
4°30'	1273.24	48	51	53	54	55	55	56	57	57	58	58	59	60	60	61	61	62	63						
5°00'	1145.92	46	49	51	52	53	53	54	54	55	56	56	57	57	58	58	59	60	60						
5°30'	1041.74	45	47	50	50	51	51	52	52	53	54	54	55	55	56	56	57	57	58	58					
6°00'	954.93	43	46	48	48	49	50	50	51	51	52	52	53	53	54	54	55	55	56	56					
6°30'	881.47	42	44	46	47	47	48	49	49	50	50	51	51	52	52	53	53	54	54	55					
7°00'	818.51	41	43	45	46	46	47	47	48	48	49	49	50	50	51	51	52	52	53	53	53				
7°30'	763.94	40	42	44	44	45	45	46	46	47	47	48	48	49	49	50	50	51	51	52	52				
8°00'	716.20	39	41	43	43	44	44	45	45	46	46	47	47	48	48	49	49	50	50	51					
8°30'	674.07	38	40	42	42	43	43	44	44	45	45	46	46	47	47	48	48	48	49	49	50				
9°00'	636.62	37	39	41	41	42	42	43	43	43	44	44	45	45	46	46	46	47	47	48	48	49			
9°30'	603.11	36	38	40	40	41	41	42	42	42	43	43	44	44	45	45	46	46	47	47	47				
10°00'	572.96	36	37	39	39	40	40	41	41	42	42	43	43	43	44	44	44	45	45	46	46	46			
10°30'	545.67	35	37	38	39	39	39	40	40	41	41	42	42	42	43	43	44	44	44	45	45	45			
11°00'	520.87	35	36	38	38	38	39	39	40	40	40	41	41	42	42	42	43	43	43	44	44	45			
11°30'	498.22	34	36	37	37	38	38	39	39	39	40	40	40	41	41	41	42	42	43	43	43	44			
12°00'	477.46	34	35	36	37	37	38	38	38	39	39	39	40	40	40	41	41	41	42	42	43	43			
14°00'	409.26	32	33	34	35	35	35	36	36	36	37	37	38	38	38	39	39	39	39	39	40	40	40		
16°00'	358.10	30	31	33	33	33	34	34	34	35	35	35	36	36	36	37	37	37	37	37	37	38	38	38	39
18°00'	318.31	29	30	31	32	32	32	33	33	33	33	34	34	34	35	35	35	35	35	36	36	36	36	37	
20°00'	286.48	28	29	30	30	31	31	31	31	32	32	32	32	33	33	33	33	34	34	34	34	34	35	35	35
22°00'	260.44	27	28	29	29	29	30	30	30	30	31	31	31	32	32	32	32	33	33	33	33	33	34	34	
24°00'	238.73	26	27	28	28	28	29	29	29	29	30	30	30	30	31	31	31	31	31	31	32	32	32	32	33
26°00'	220.37	25	26	27	27	28	28	28	28	28	29	29	29	29	30	30	30	30	30	31	31	31	31	31	
28°00'	204.63	25	25	26	27	27	27	27	28	28	28	28	28	28	29	29	29	29	29	30	30	30	30	31	
30°00'	190.99	24	25	26	26	26	26	26	27	27	27	27	28	28	28	28	28	28	28	29	29	29	29	29	
32°00'	179.05	23	24	25	25	25	26	26	26	26	26	27	27	27	27	27	28	28	28	28	28	28	29	29	
34°00'	168.52	23	24	24	25	25	25	25	25	26	26	26	26	26	26	27	27	27	27	27	27	28	28	28	
36°00'	159.15	22	23	24	24	24	24	25	25	25	25	25	26	26	26	26	26	26	27	27	27	27	27	27	

$R = V^2 / [15(e+f)]$
 e=rate of superelevation
 f= sidefriction factor
 V= Vehicle speed, mph
 R=Radius, ft

Speed	Friction Factor
25	0.23
30	0.20
35	0.18
40	0.16
45	0.15
50	0.14
55	0.13
60	0.12
65	0.11
70	0.10

218.8 Horizontal Curve Equations and Examples

ODOT standard horizontal alignments typically use transition spirals instead of the basic circular curve. The following figures present the circular curve definitions, spiral curve definitions, basic curve formulas, and accompanying nomenclature. Figure 200-23 describes the circular curve definition, Figure 200-24 through Figure 200-26 describe the spiral curve definition, and Figure 200-27 and Figure 200-28 describe the basic curve formulas. Figure 200-29 through Figure 200-49 provide detailed information and potential solutions for reversing horizontal curves and spiral segment layout.

Figure 200-23: Circular Curve Definitions

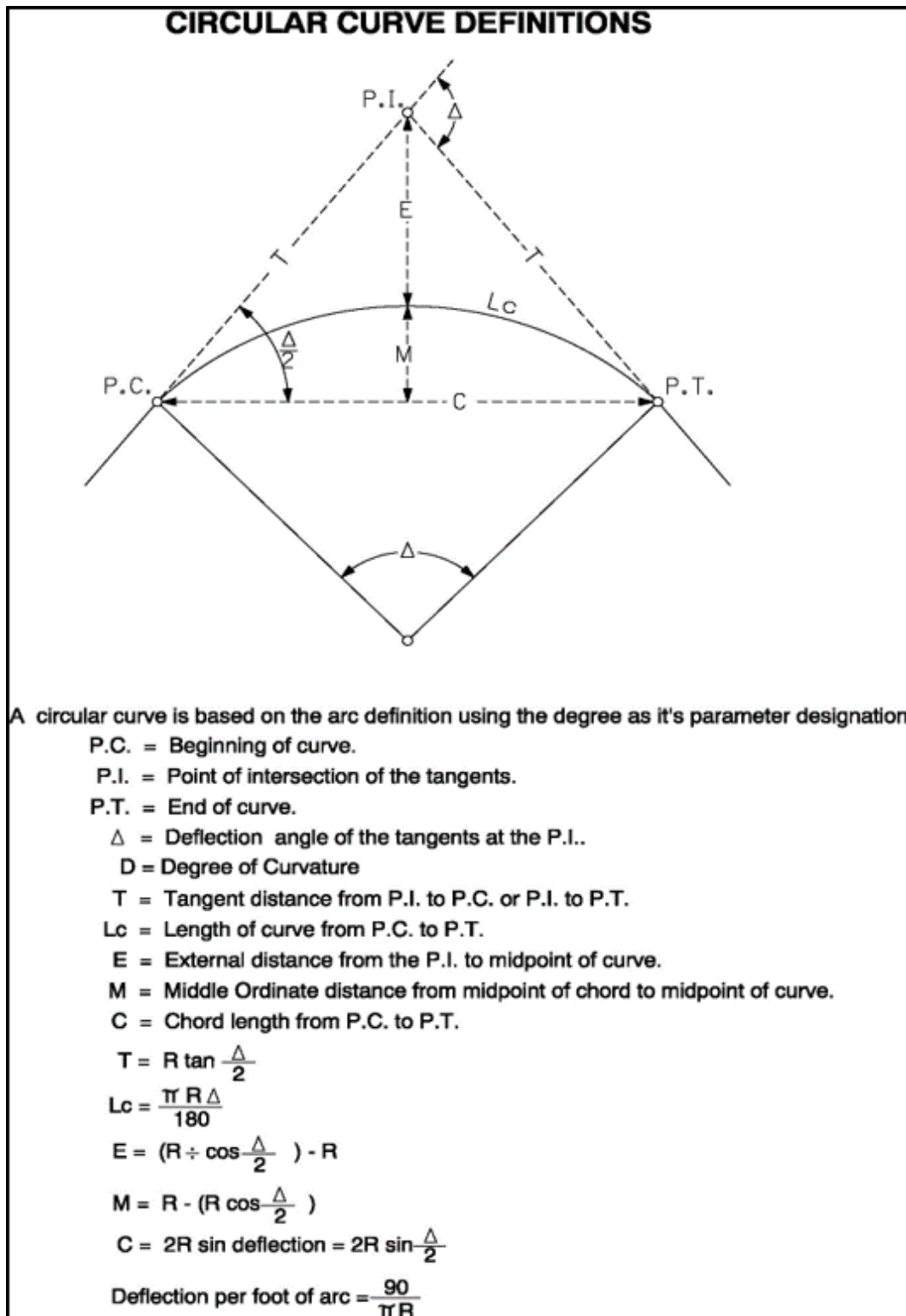

Figure 200-24: Spiral Curve Definitions

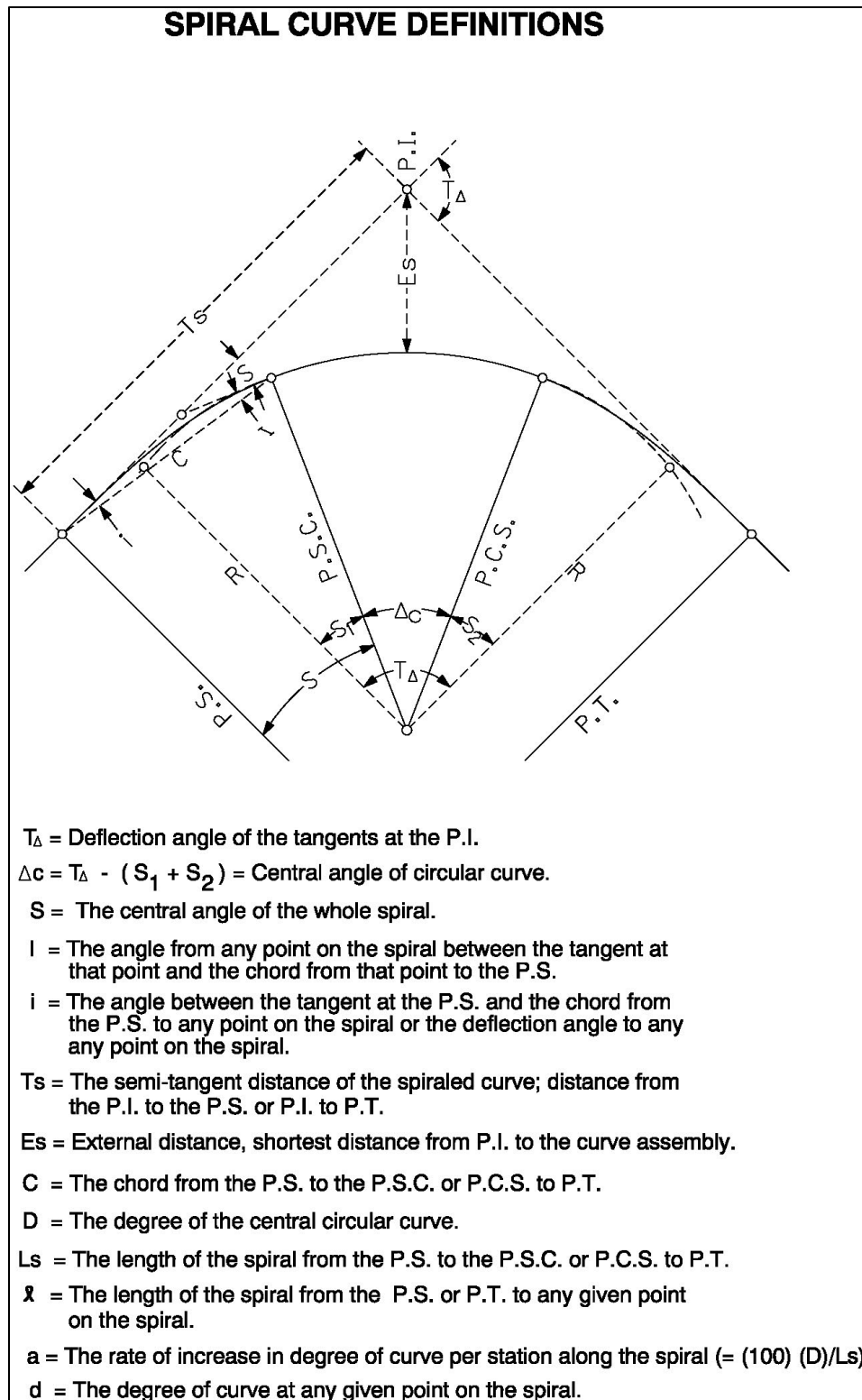

Figure 200-25: Spiral Curve Definitions (Cont'd)

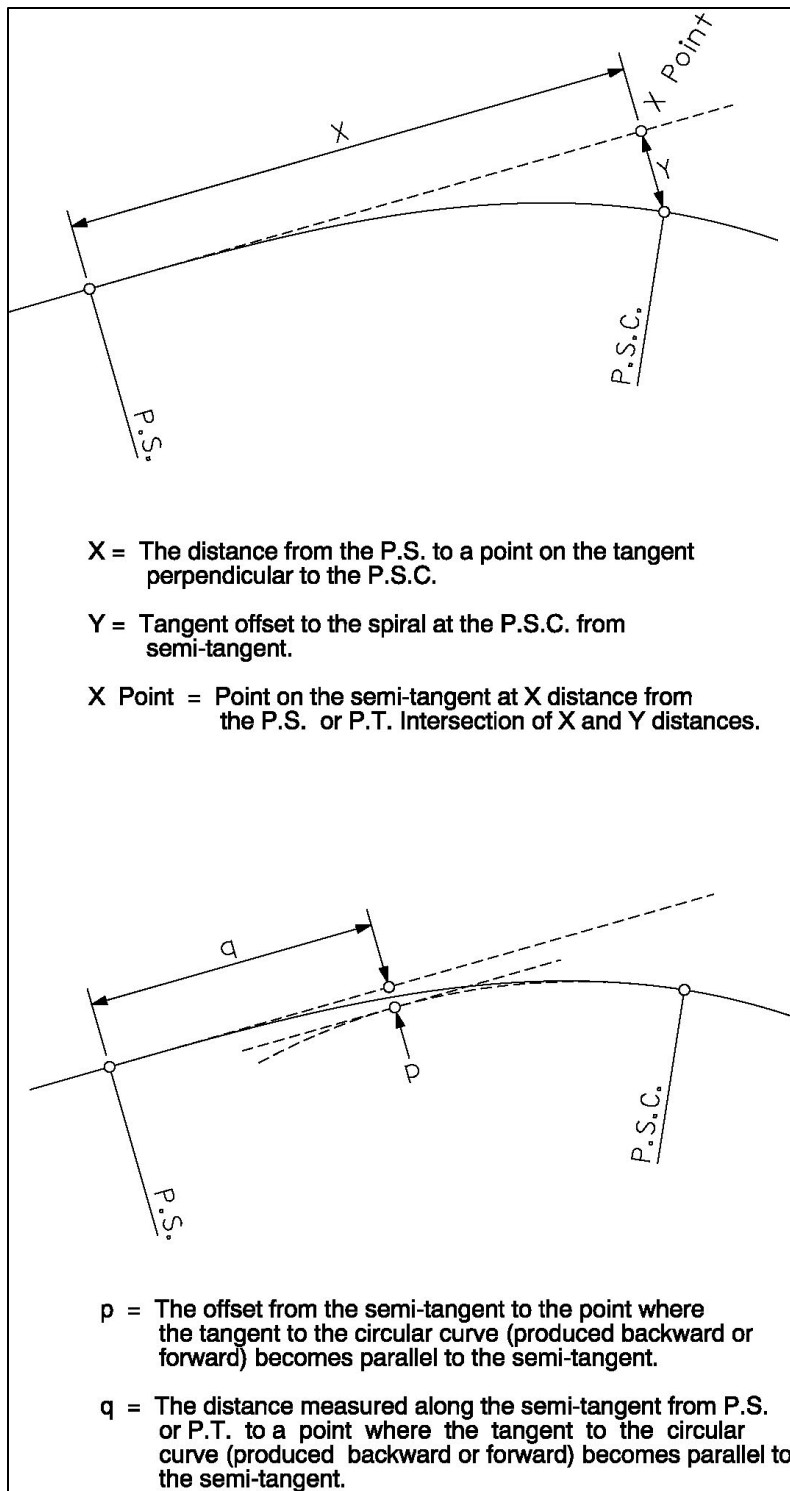

Figure 200-26: Spiral Curve Definitions (Cont'd)

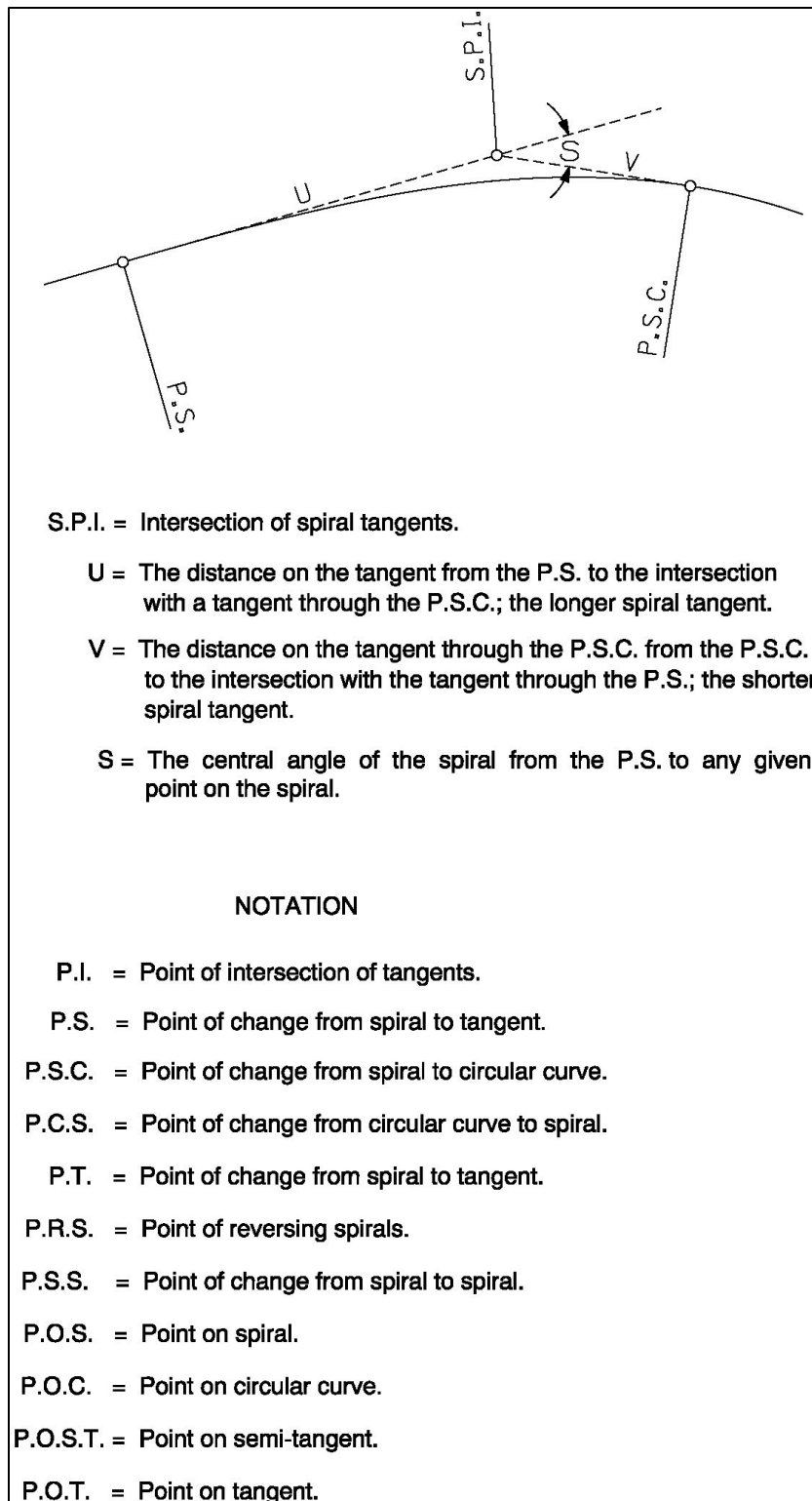

Figure 200-27: Basic Horizontal Curve Formulas

BASIC FORMULAS

Spiral Definition
 The Standard Highway Spiral is a curve whose degree varies directly with its length, beginning at infinity at the P.S. and reaching a degree of curve equal to the circular curve at the P.S.C.

$\pi = 3.1415926536$

1 Radian = 57.295779513°

$a = [(100)(D)/Ls]$

$D = [(a)(Ls)/100] = [(200)(S)/Ls]$

$Ls = (100)(D)/a = (200)(S)/D$

S = Spiral Angle in Degrees

$S = (D)(Ls)/200 = (a)(Ls^2)/20,000 = (D^2)/(2)(a)$

$R = 5729.5779513/D = (5729.5779513)(Ls)/(200)(S) = (28.647889757)(Ls)/S$

$$\frac{X}{Ls} = \sum \left(\frac{\theta^{2n-2}}{(2n-2)! (4n-3) (-1)^{n+1}} \right)$$

$$\frac{Y}{Ls} = \sum \left(\frac{\theta^{2n-1}}{(2n-1)! (4n-1) (-1)^{n+1}} \right)$$

Following is the expanded form for values to n = 8 ("n" is not equal to 0)

$\theta = S$ in Radians

$$X = Ls \left(1 - \frac{\theta^2}{10} + \frac{\theta^4}{216} - \frac{\theta^6}{9360} + \frac{\theta^8}{685,440} - \frac{\theta^{10}}{76,204,800} + \frac{\theta^{12}}{11,975,040,000} - \frac{\theta^{14}}{2,528,170,444,800} \right)$$

$$Y = Ls \left(\frac{\theta}{3} - \frac{\theta^3}{42} + \frac{\theta^5}{1320} - \frac{\theta^7}{75,600} + \frac{\theta^9}{6,894,720} - \frac{\theta^{11}}{918,086,400} + \frac{\theta^{13}}{168,129,561,600} - \frac{\theta^{15}}{40,537,905,408,000} \dots \right)$$

Note: Designations of X and Y have been reversed to match most software. The ODOT Standard Highway Spiral Book values for X and Y are still accurate, just reversed.

Figure 200-28: Basic Horizontal Curve Formulas (Cont'd)

$$\tan i = \frac{Y}{X}$$

$$I = S - i$$

$$q = X - R \sin S = X - \frac{28.647\ 889\ 757\ Ls}{S} \sin S$$

$$p = Y - R (1 - \cos S) = Y - \frac{28.647\ 889\ 757\ Ls}{S} (1 - \cos S)$$

$$U = X - \frac{Y}{\tan S}$$

$$V = \frac{Y}{\sin S}$$

$$C = \sqrt{X^2 + Y^2}$$

$$Ts = q + (R + p) \tan \frac{T\Delta}{2}$$

$$Es = \frac{R + p}{\cos \frac{T\Delta}{2}} - R$$

$$Lc = \text{Length of circular curve} = \frac{\pi R \Delta_c}{180} = \frac{\pi R (T\Delta - S_1 - S_2)}{180}$$

Note: Designations of X and Y have been reversed to match most software. The ODOT Standard Highway Spiral Book values for X and Y are still accurate, just reversed.

Figure 200-29: Parallel Tangents - Equal Length Reversing Curves

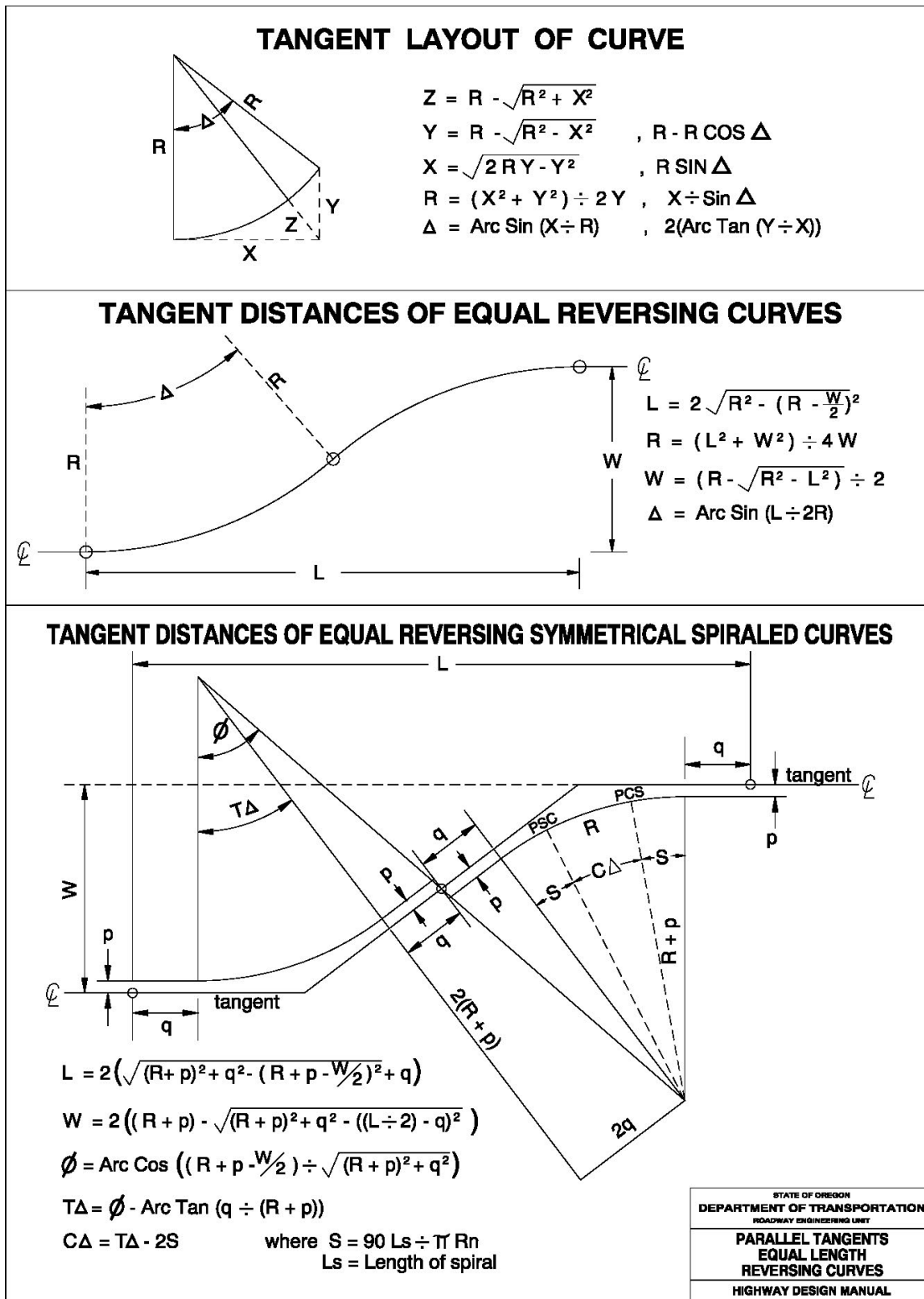

Figure 200-30: Parallel Tangents - Unequal Length Reversing Curves

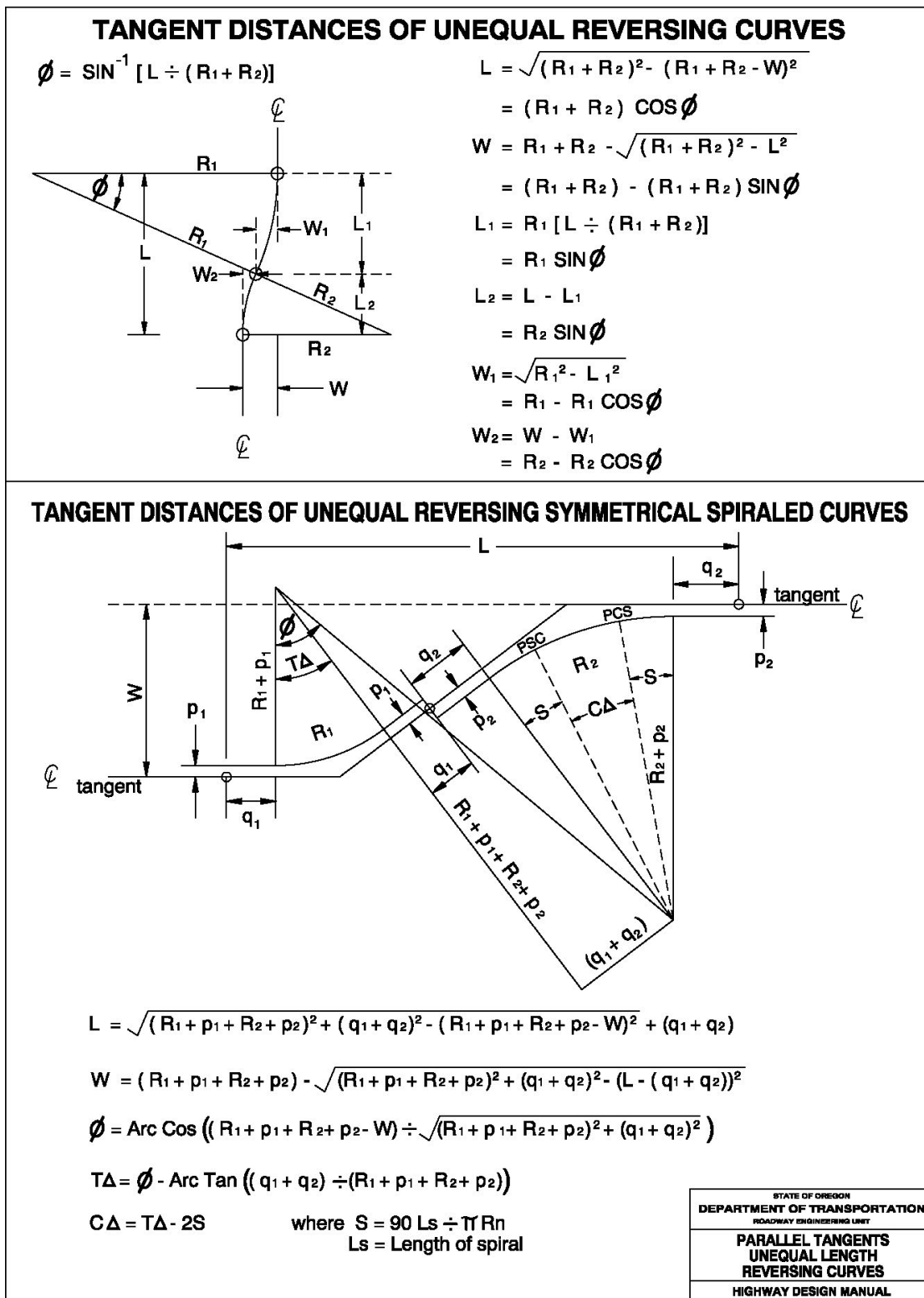

Figure 200-31: Spiral Solution - Example 1

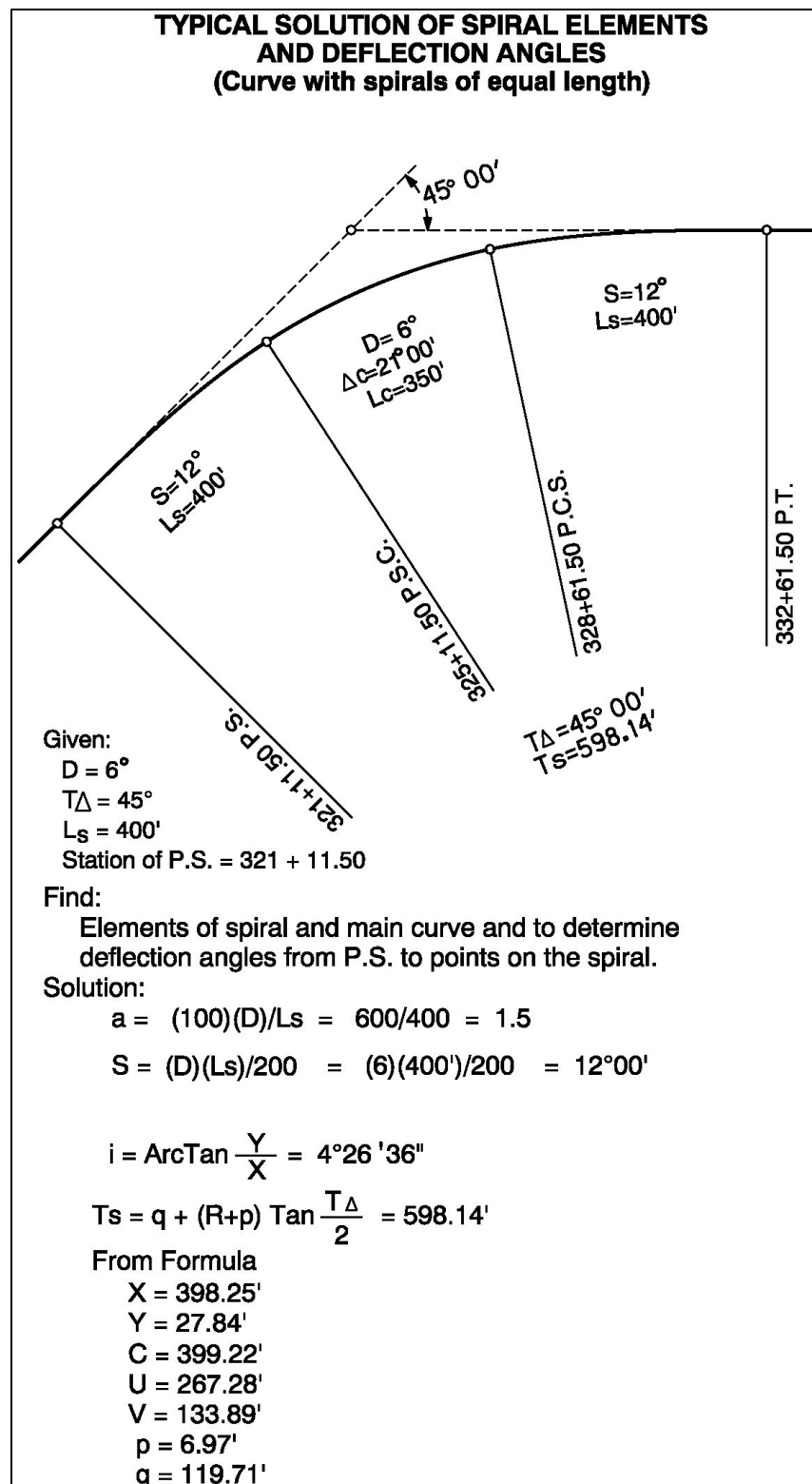

Figure 200-32: Spiral Solution - Example 2

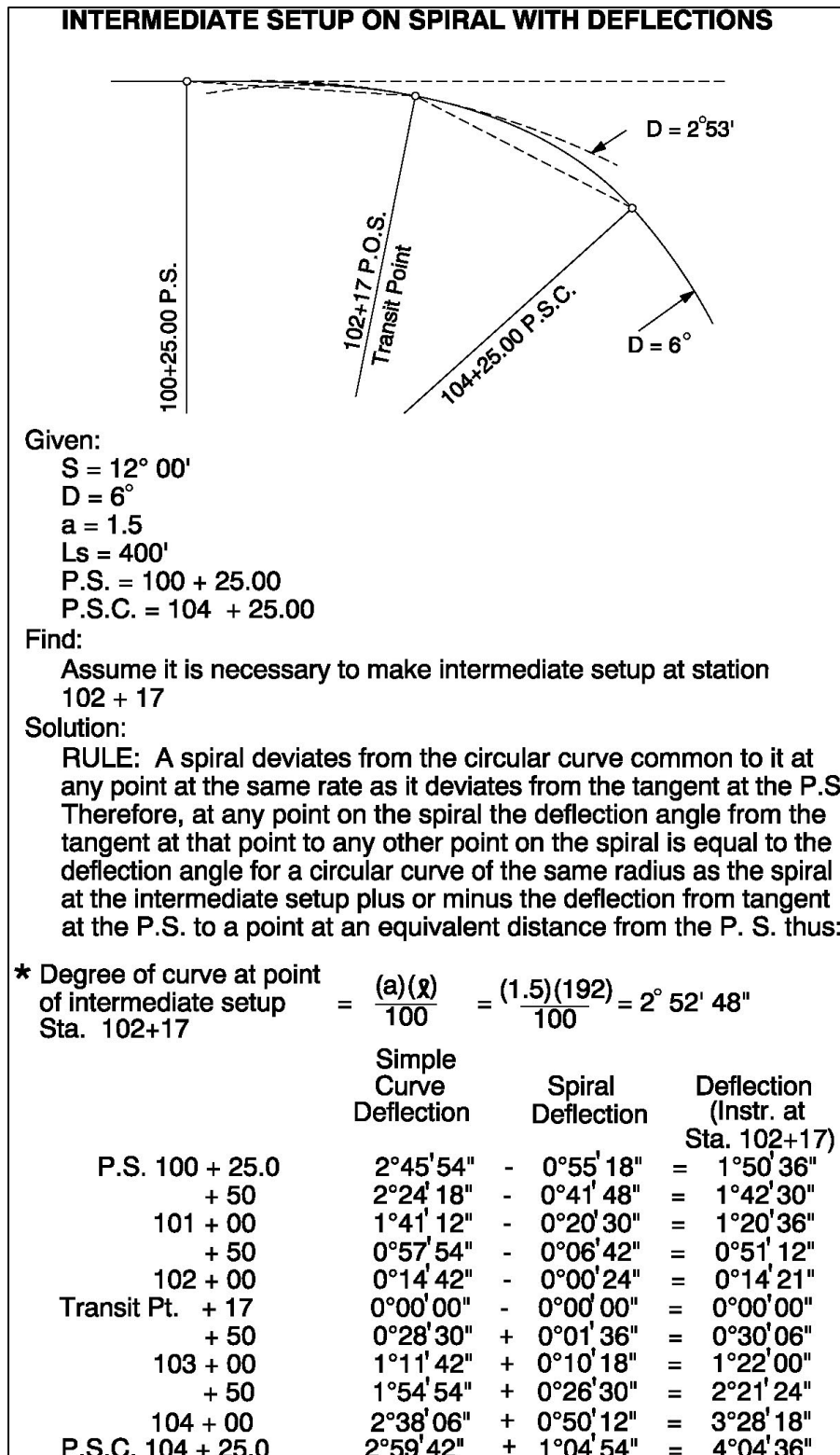

Figure 200-33: Spiral Solution - Example 3

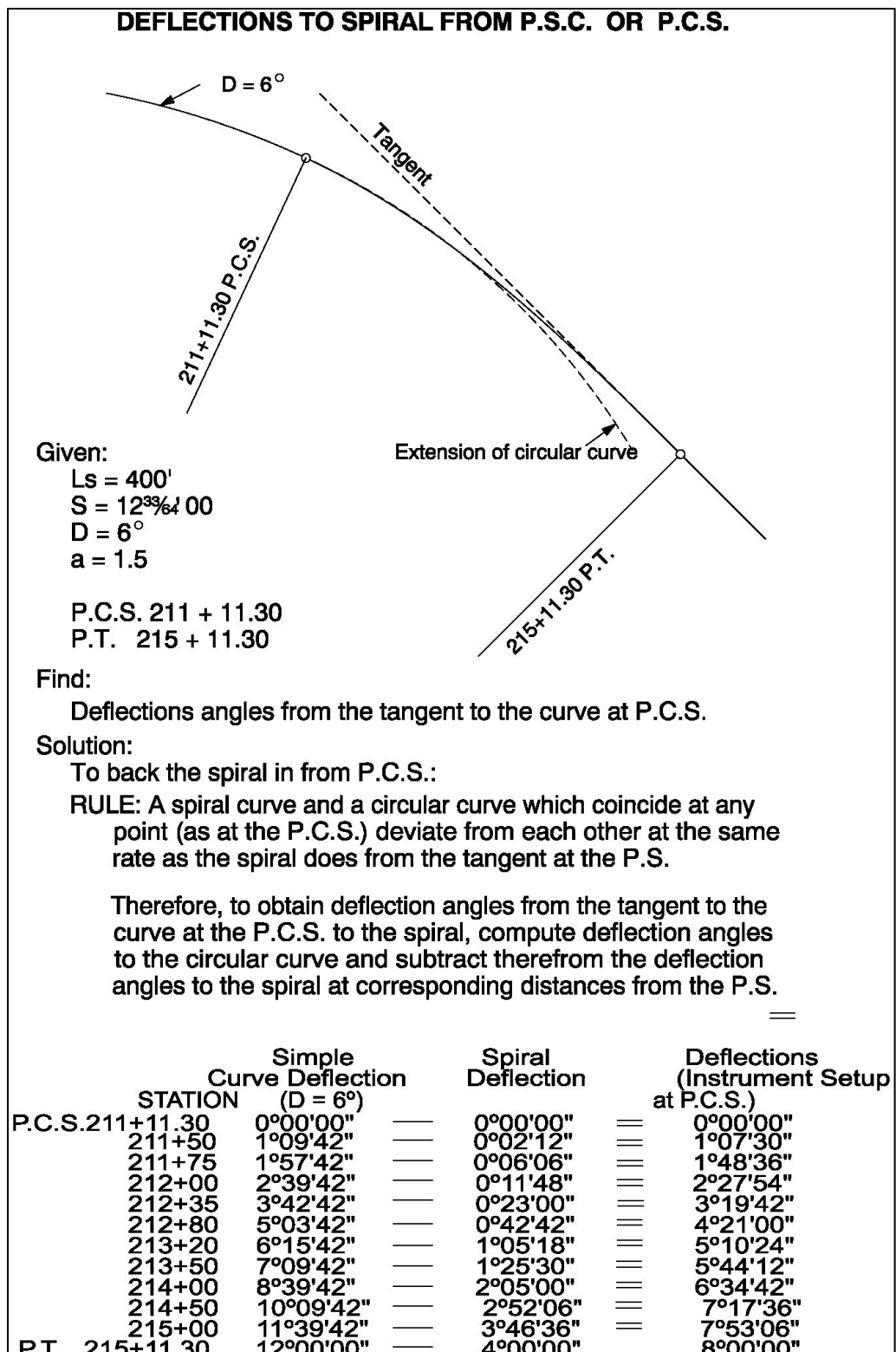

Figure 200-34: Spiral Solution - Example 4

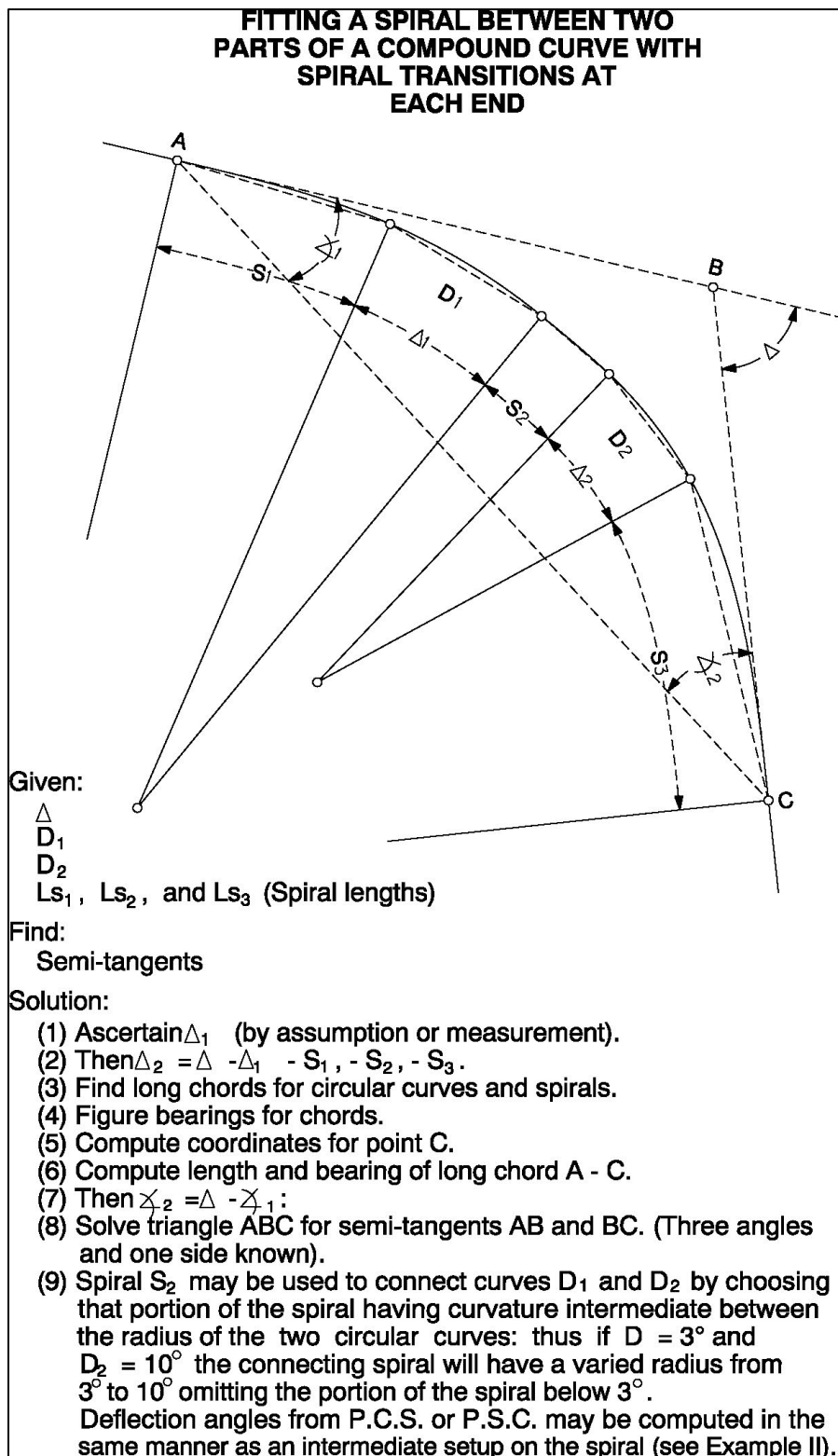

Figure 200-35: Spiral Solution - Example 5

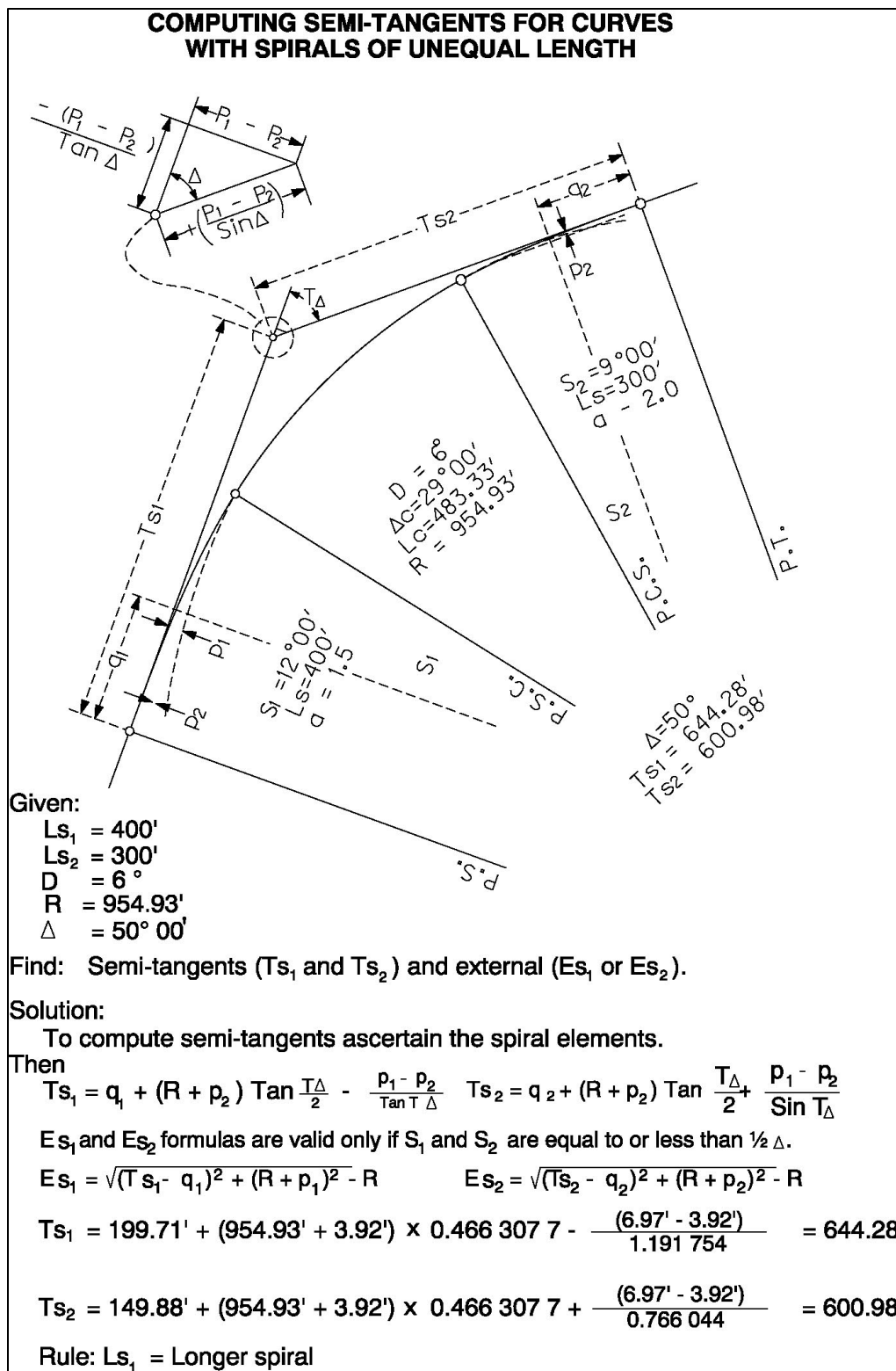

Figure 200-36: Spiral Solution - Example 6

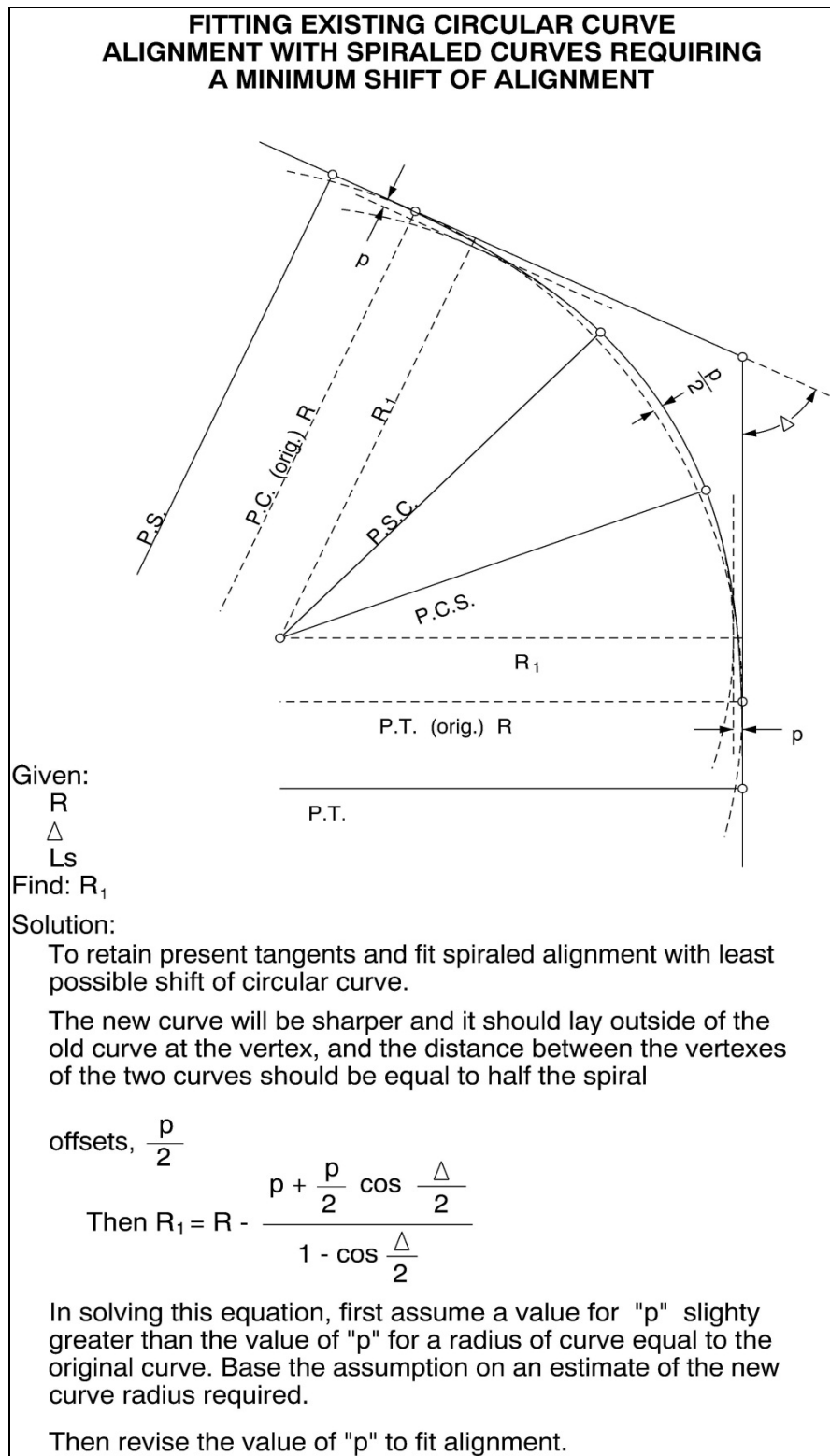

Figure 200-37: Spiral Solution - Example 7

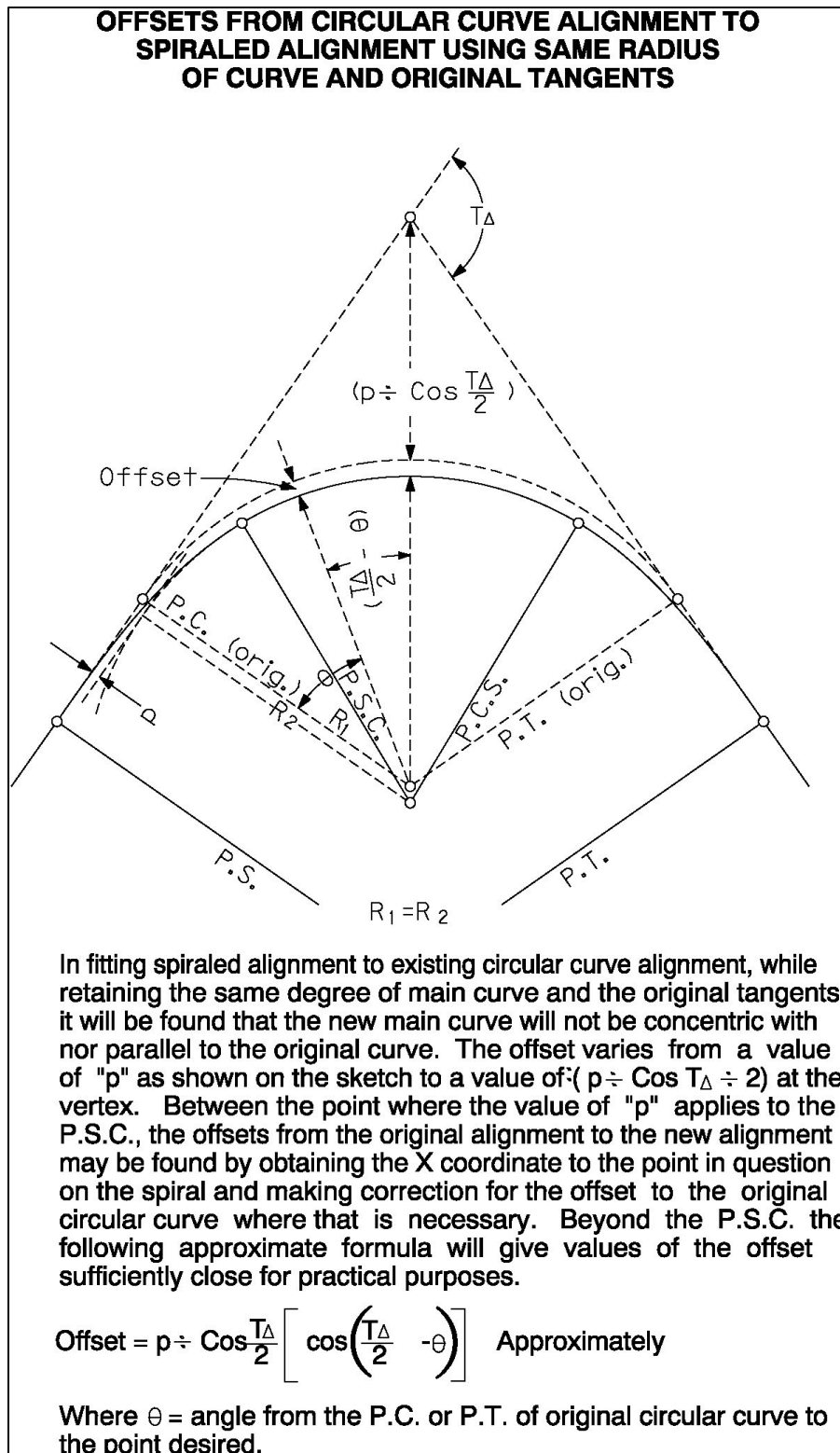

Figure 200-38: Spiral Solution - Example 8

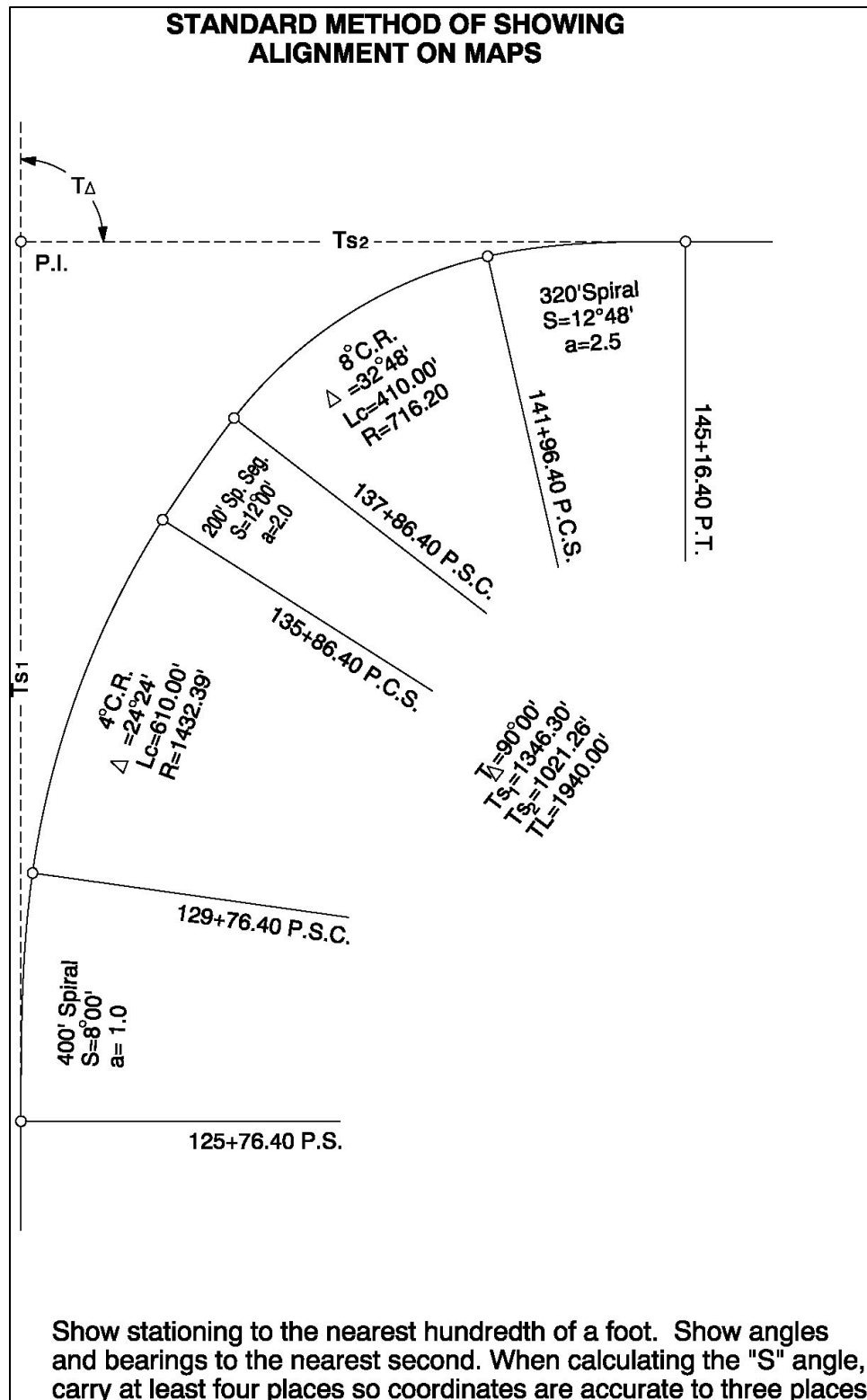

Figure 200-39: Spiral Solution - Example 9

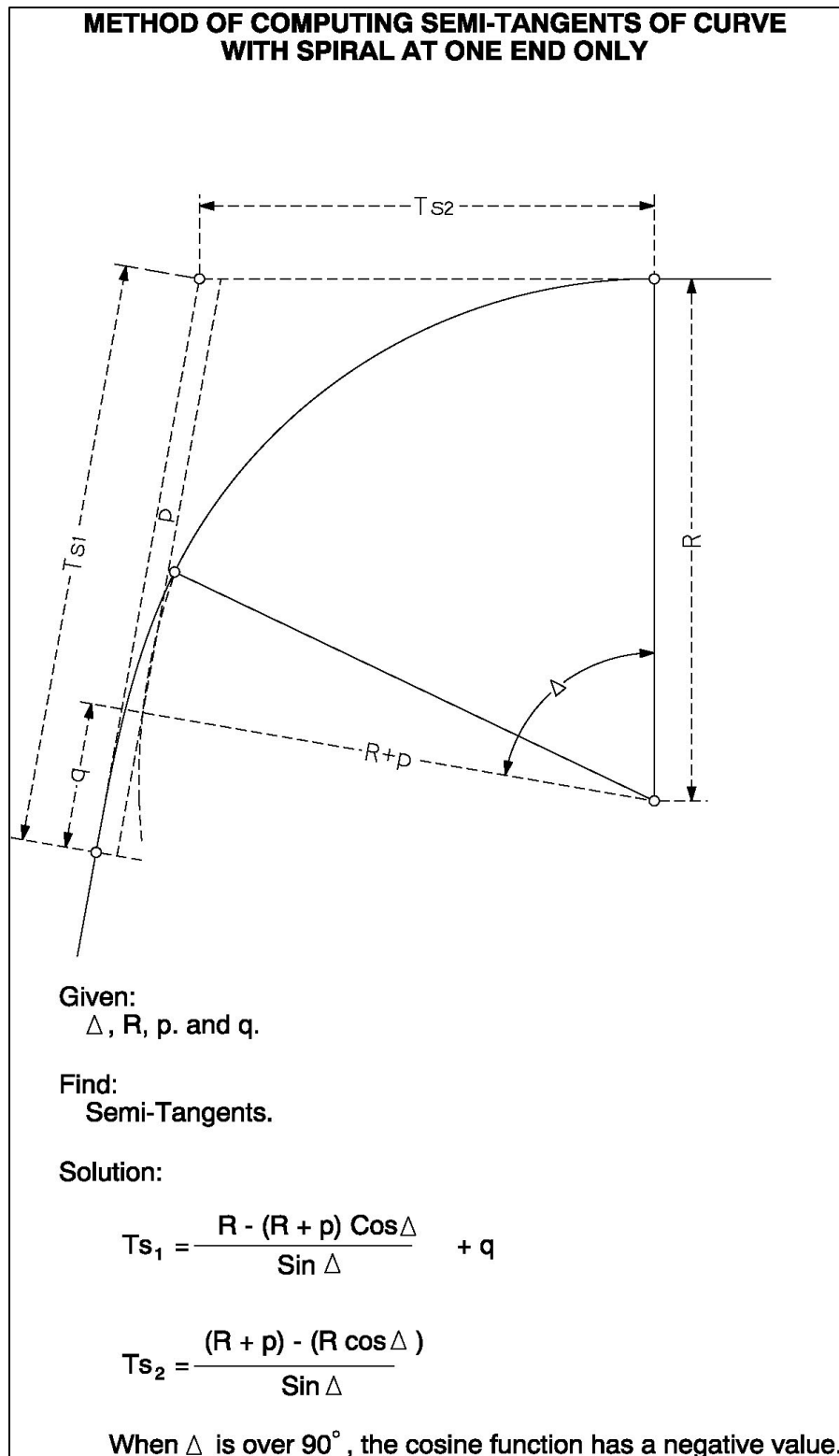
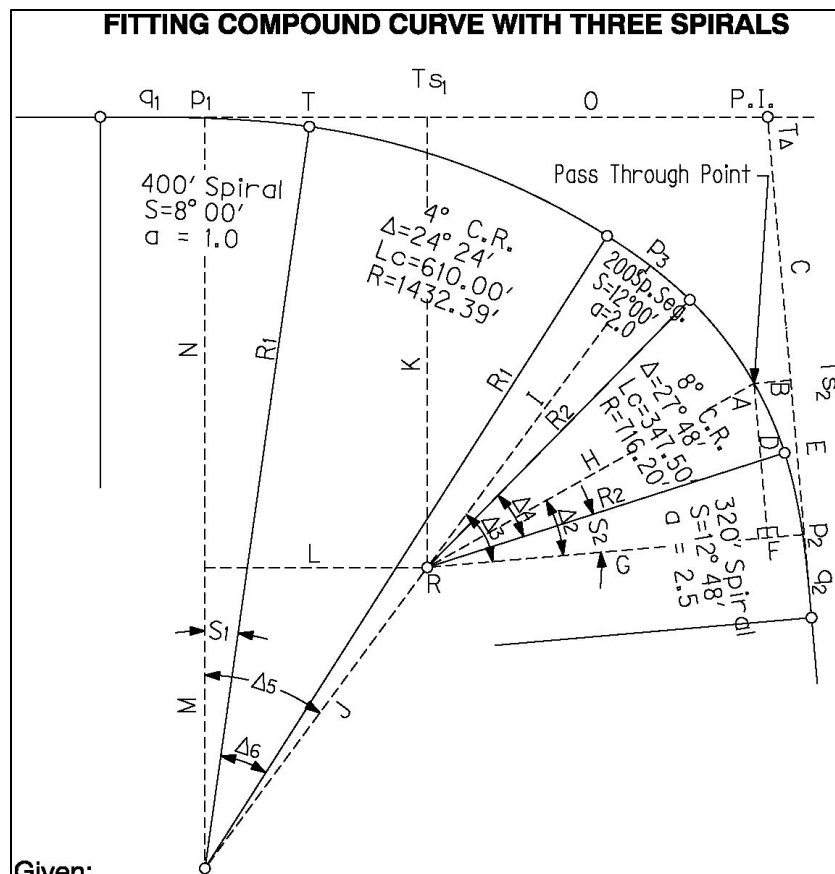

Figure 200-40: Spiral Solution - Example 10



Given:

With a fixed pass through point or a given or assumed semi-tangent (Ts_2), known P.I., $T\Delta$, R_1 and R_2 , spiral lengths.

Find:

Ts_2 (for fixed point) or Ts_1 (for known Ts_2)

Solution:

FIXED PASS THROUGH POINT

Calculate C and B along and perpendicular to the Ts semi-tangent tangent Then

$$B = F, G = (R_2 + p_2) - F, H = R_2, \cos \Delta_2 = \frac{G}{H}, D = H \sin \Delta_2,$$

$$E = D \text{ and } Ts_2 = C + E + q_2$$

GIVEN OR ASSUMED SEMI-TANGENT (Ts_2)

Calculate coordinates for the radius point of " R_2 " from Ts_2 . Calculate O and K along and perpendicular to the Ts_1 , semi-tangent. ' p_3 ' is the perpendicular distance between R_1 and R_2 , when tangent to each other. Then $I = R_2 + p_3$.

$$J = R_1 - I, K = N, M = (R_1 + p_1) - N, \cos \Delta_5 = \frac{M}{J}, L = J \sin \Delta_5,$$

$T = L, \Delta_6 = \Delta_5 - (S_1 + \Delta \text{ for } D_1 \text{ for } \frac{1}{2} \text{ length of intermediate spiral}), \Delta_3 = T\Delta - \Delta_5, \Delta_4 = \Delta_3 - (S_3 + \Delta \text{ for } R_2 \text{ for } \frac{1}{2} \text{ length of intermediate spiral})$
 $Ts_1 = O + T + q_1$; the use of $\frac{1}{2}$ the length of the intermediate spiral is a close approximation of the true answer.

Figure 200-41: Spiral Solution - Example 11

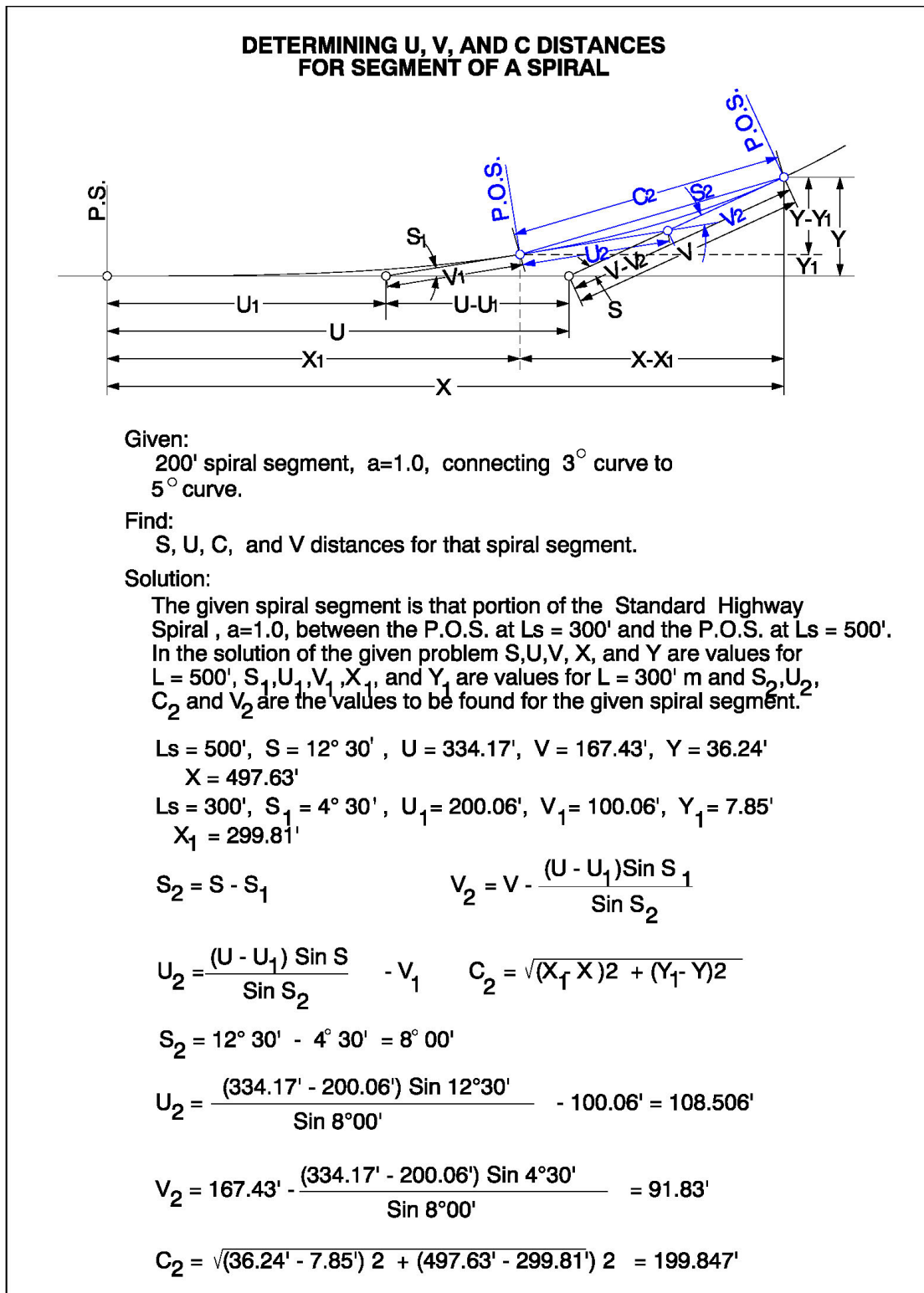

Figure 200-42: Spiral Solution - Example 12

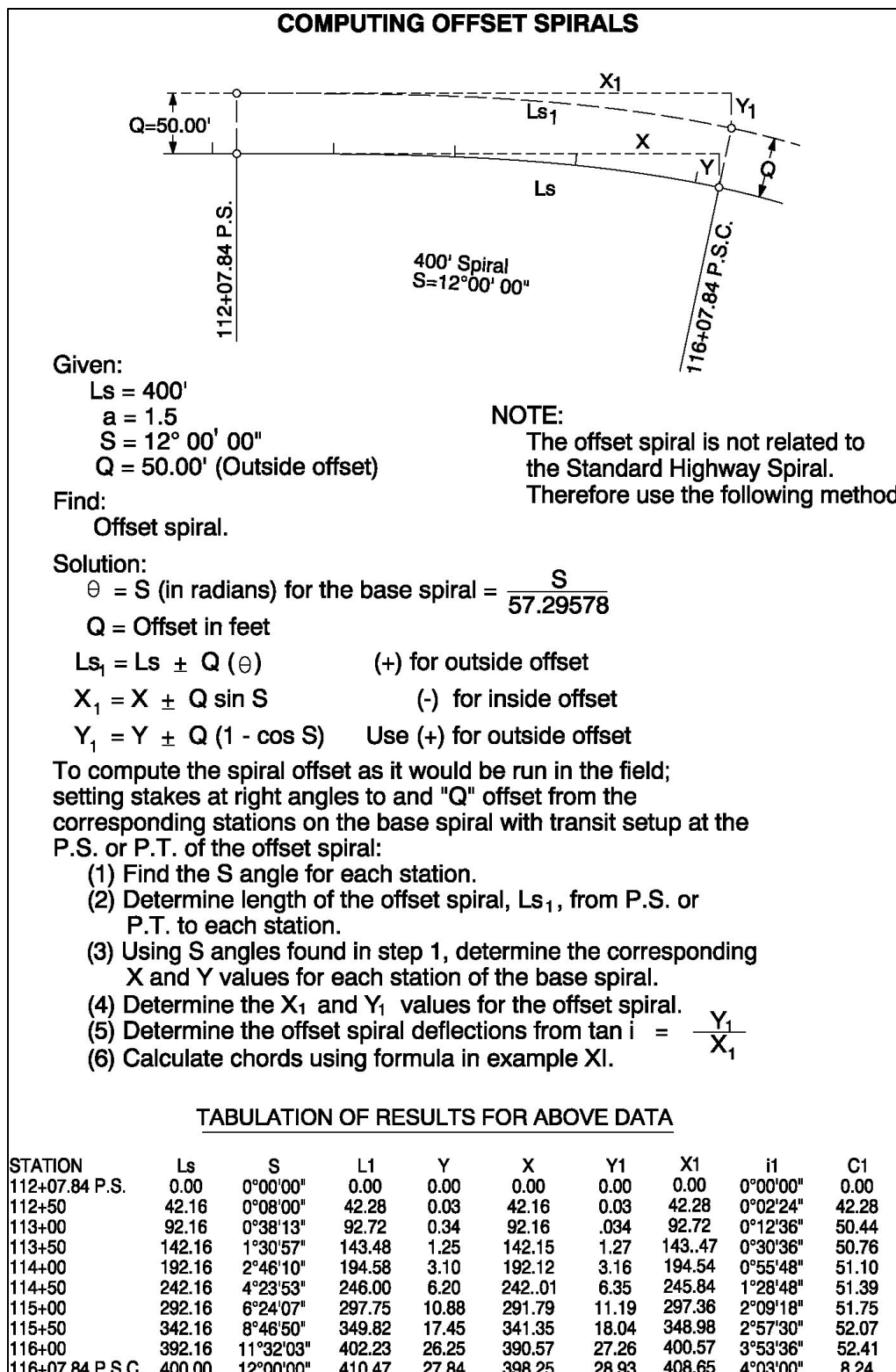
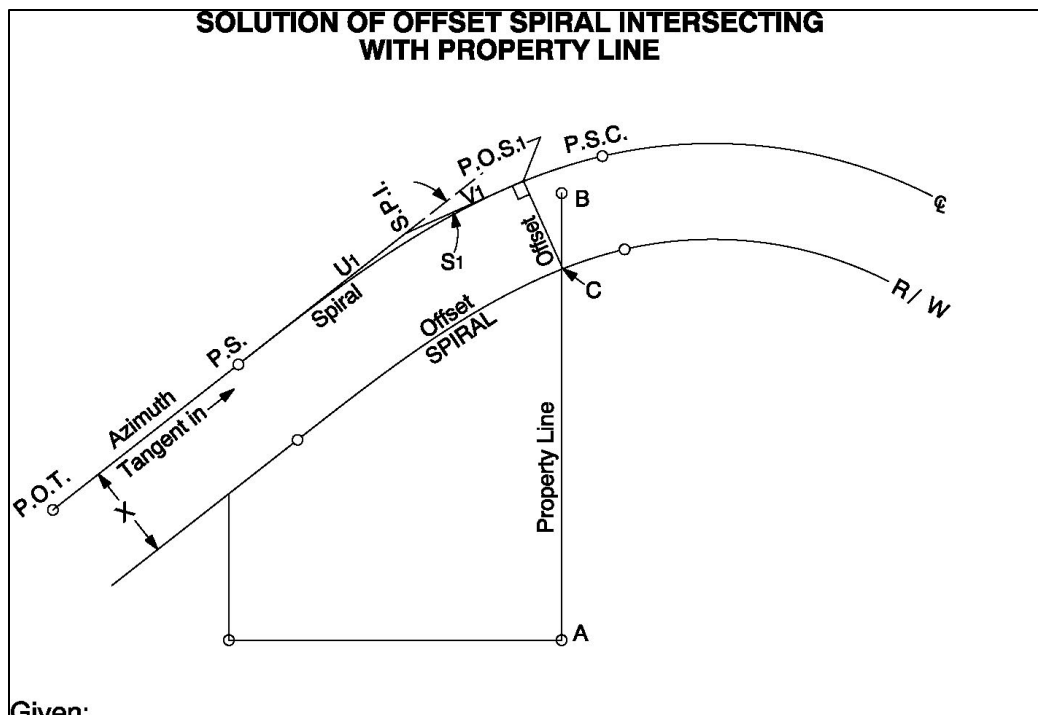

Figure 200-43: Spiral Solution - Example 13



Given:

Centerline geometry, offset value, coordinate of P.O.T. on tangent in, azimuth of tangent in, coords of point A and B or coords of A or B and azimuth to the other. "Lg" is a generic value representing the guess length of spiral to offset point.

Find:

Coordinate of intersect point C.

Solution:

This problem has no direct solution. It can be solved by iteration. This is not as difficult as it seems.

Begin at the P.S. of the spiral and guess an "Lg" length. Using the "Lg" and the "a" value generate "U₁" and "V₁" and "S" values for trial solution. The solution is to coordinate from the P.S. to the S.P.I. to the P.S.C. of the P.O.S. along the spiral. Next coordinate a point "C" from the P.O.S.₁ 90° off the tangent between the S.P.I. and P.O.S. out the offset distance "X". Finally inverse between point "C" and point "A" and determine the azimuth of point "C" to "A". Compare this azimuth to the azimuth between point "B" to "A". When azimuths are identical you have solved for the intersect.

ALGORITHM FOR ITERATION

- Lg₁ = Guess₁ = Length of spiral for Trial #1
- Lg₂ = Guess₂ = Length of spiral for Trial #2
- Ls₃ = ? = Projected length from linear regression

"Equation" is all calculations to produce difference in azimuths (d₁, d₂).

Solve "equation" using Lg₁ - result is z₁

Solve "equation" using Lg₂ - result is z₂

Given Lg₁, z₁, Lg₂, z₂, compute Ls₃:

$$Ls_3 = Lg_2 - (z_2 (Lg_1 - Lg_2) / (z_1 - z_2))$$

Figure 200-44: Spiral Solution - Example 14

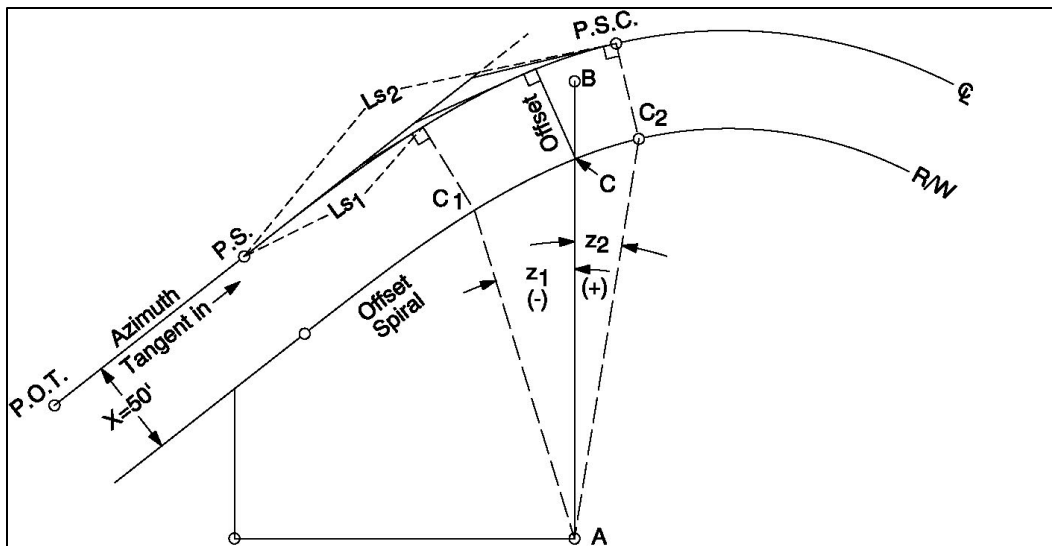

Given:

Centerline geometry, D - 8, Spiral 400', offset 50', coordinate of P.O.T. on tangent in, azimuth of tangent in, coords of point "A" and "B" or coords of (A or B) and azimuth to the other.

Find:

Coordinate of intersect point C.

Solution:

$$Lg_1 = \text{Guess}_1 = 300' \quad Lg_2 = \text{Guess}_2 = 400'$$

Calculate "z₁" by assuming a "Ls₁" length and computing for "U₁", "V₁" and "S₁". Turn a 90° and "X" distance from "V₁" tangent at point on spiral to offset spiral. Inverse between point "C₁" and "A" for azimuth. Take the difference between "C" to "A" and "B" to "A" and this is angle z₁. Repeat steps for z₂.

Note:

To reduce the number of iterations select "Lg₁" and "Lg₂" as close as possible to point "C". Keep in mind the positive and negative "z" values.

$$Ls_3 = 400' - (8.9151 (300' - 400') / (-3.3458 - 8.9151)) = 327.28839'$$

$$Ls_3 = 327.28839' - (0.299(400' - 327.28839') / (8.9151 - 0.299)) = 324.76512'$$

$$Ls_3 = 324.76512' - (-0.0276(327.28839' - 324.76512') / (0.299 - (-0.0276))) = 324.97835'$$

$$Ls_3 = 324.97835' - (0.0001 (324.76512' - 324.97835') / (-0.0276 - (0.0001))) = 324.97758'$$

In this example the L₃ starts to repeat itself to significant figures, & it is solved.

Flow Diagram for "Lg" in Ls₃ equation

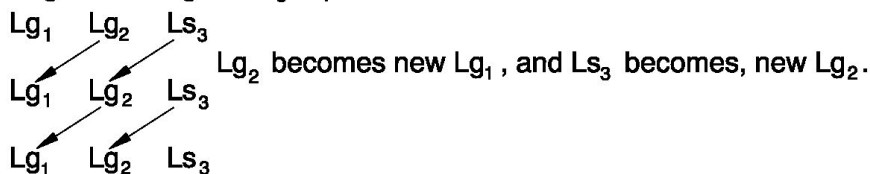

Figure 200-45: Establish Local Tangent on Horizontal Curves

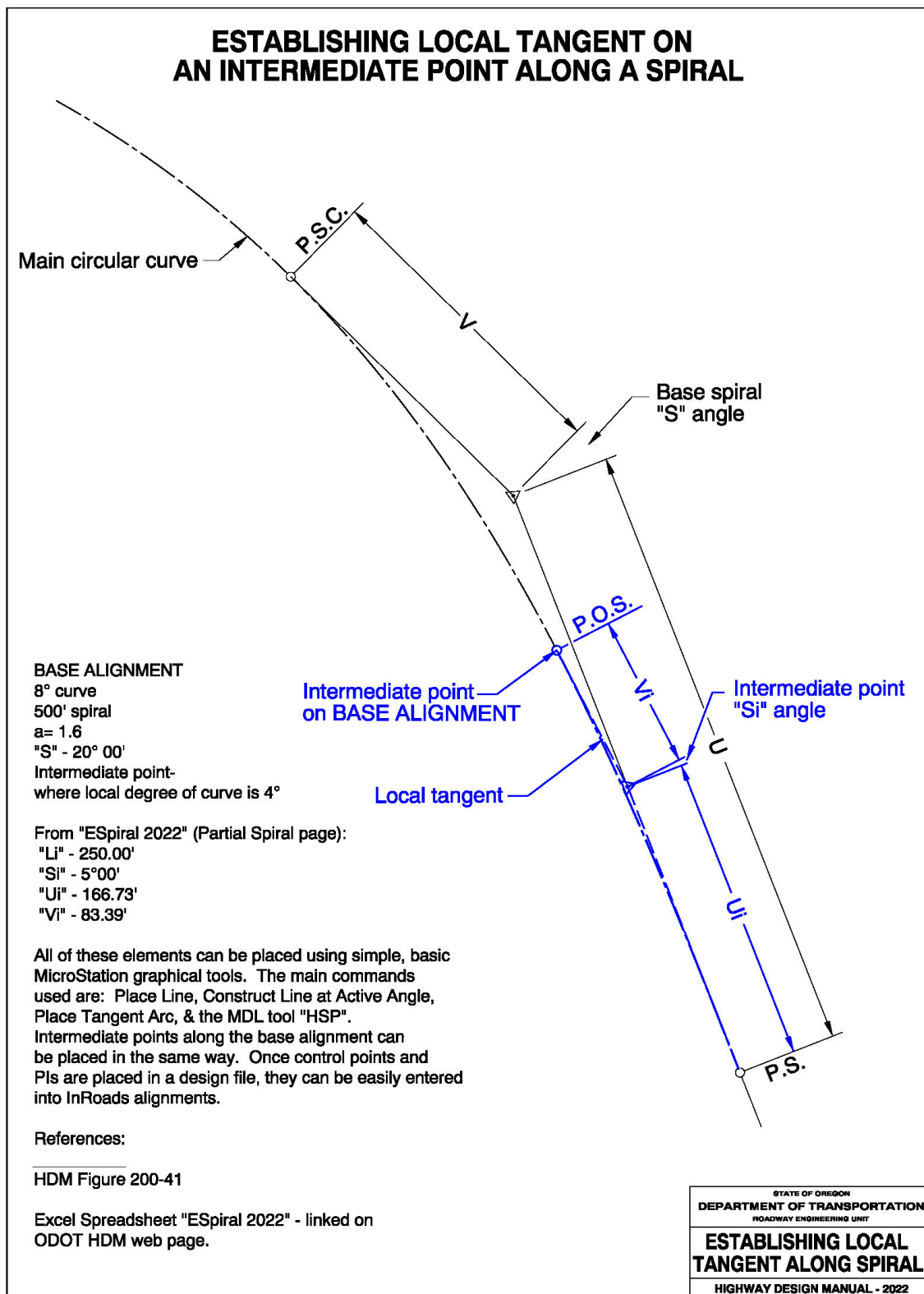

Figure 200-46: Using Spiral Segment in Compound Horizontal Curve Situations

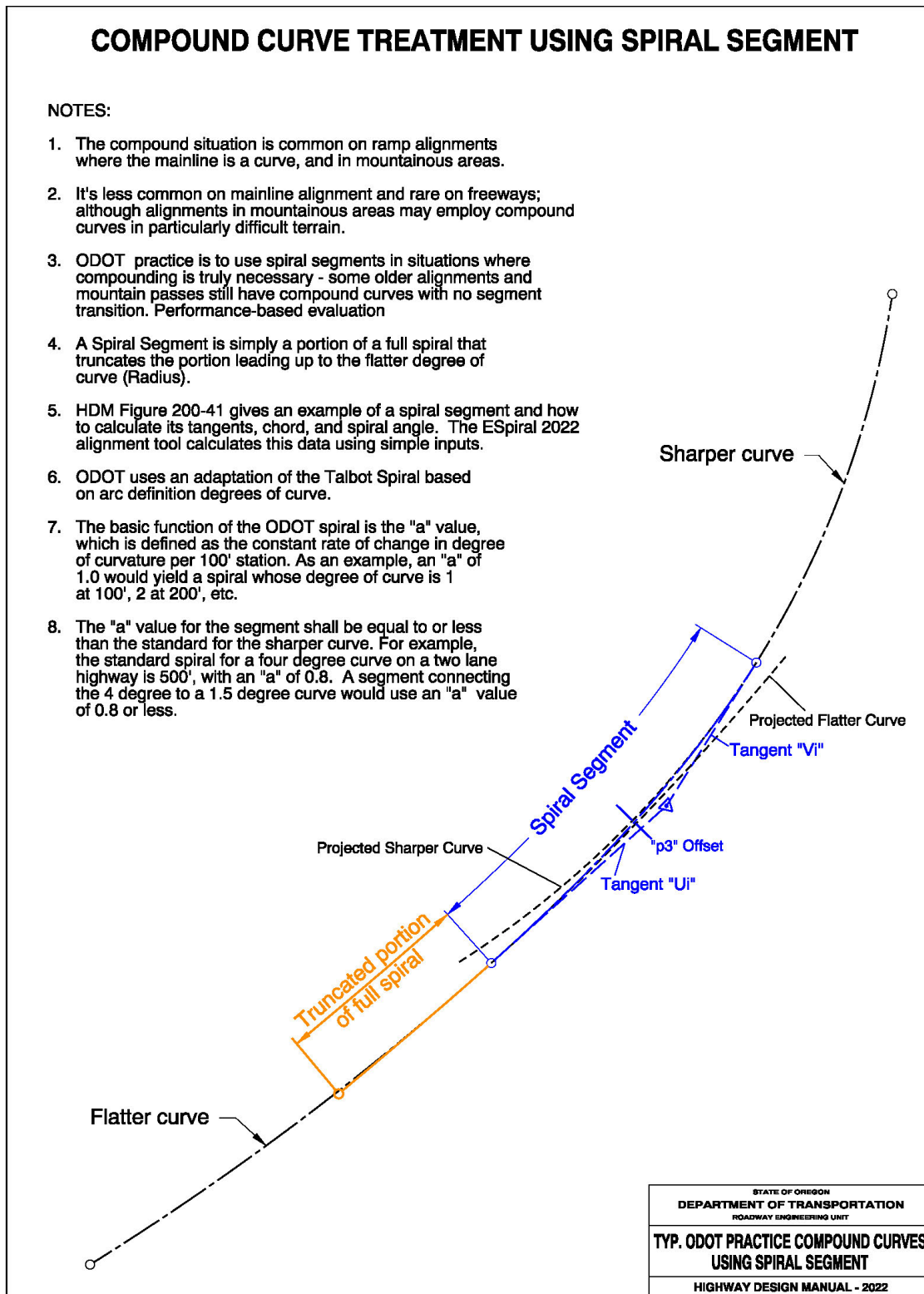

Figure 200-47: Establishing Ramp Takeoff/Touchdown Points and Ramp Angles from Local Tangent

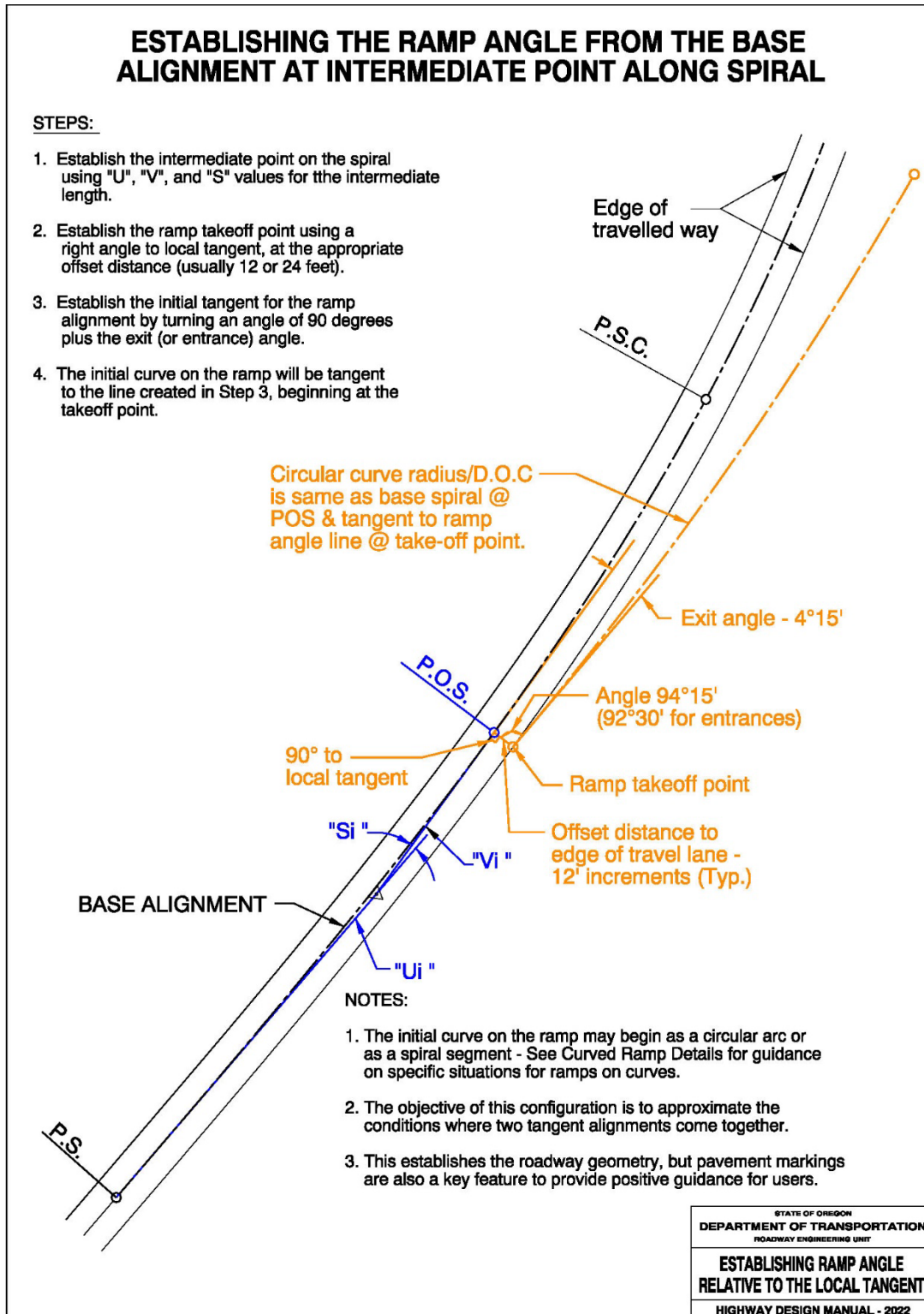

Figure 200-48: Establishing Spiral Segment Control Points
(in conjunction with ESpiral 2022 spreadsheet)

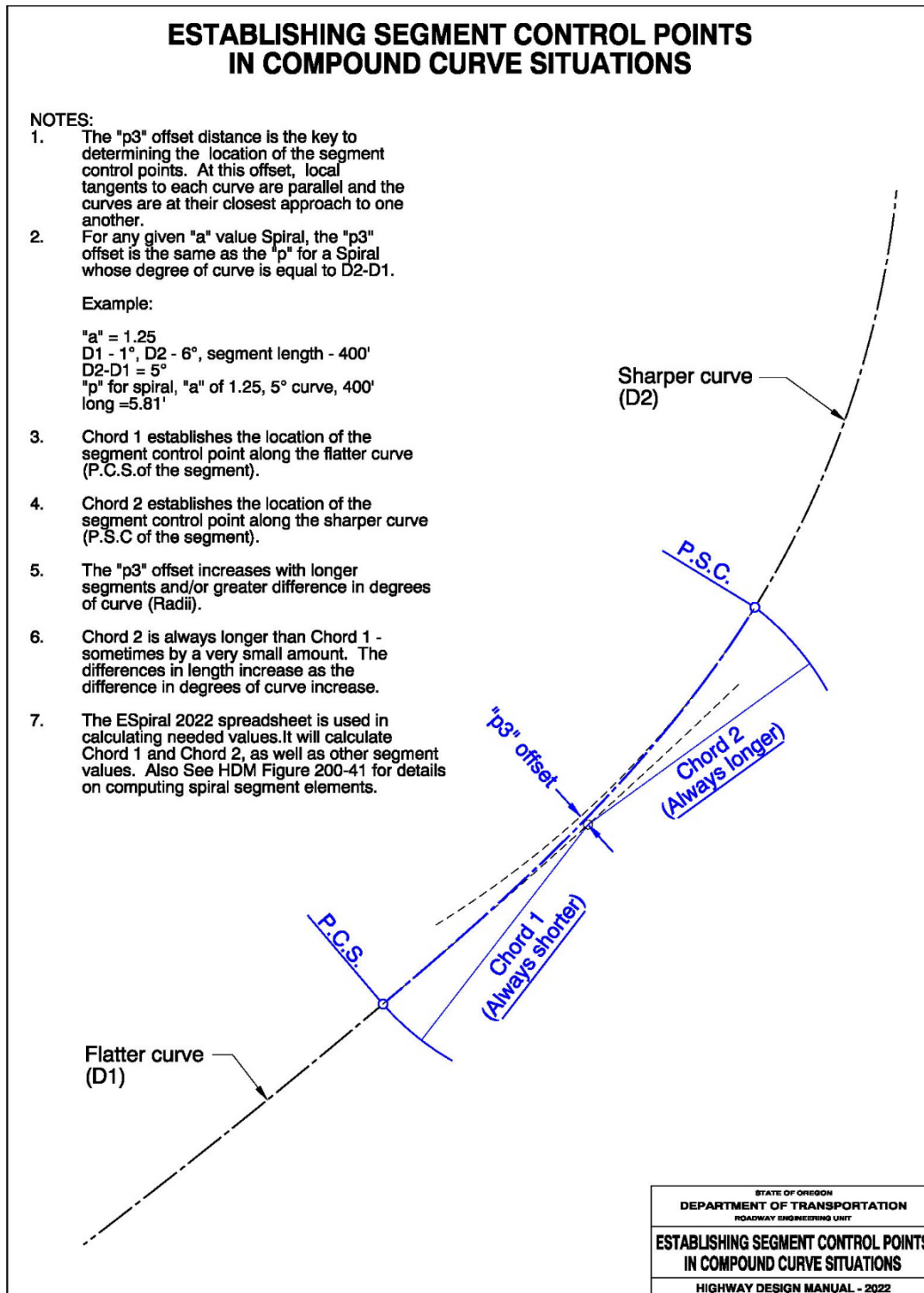
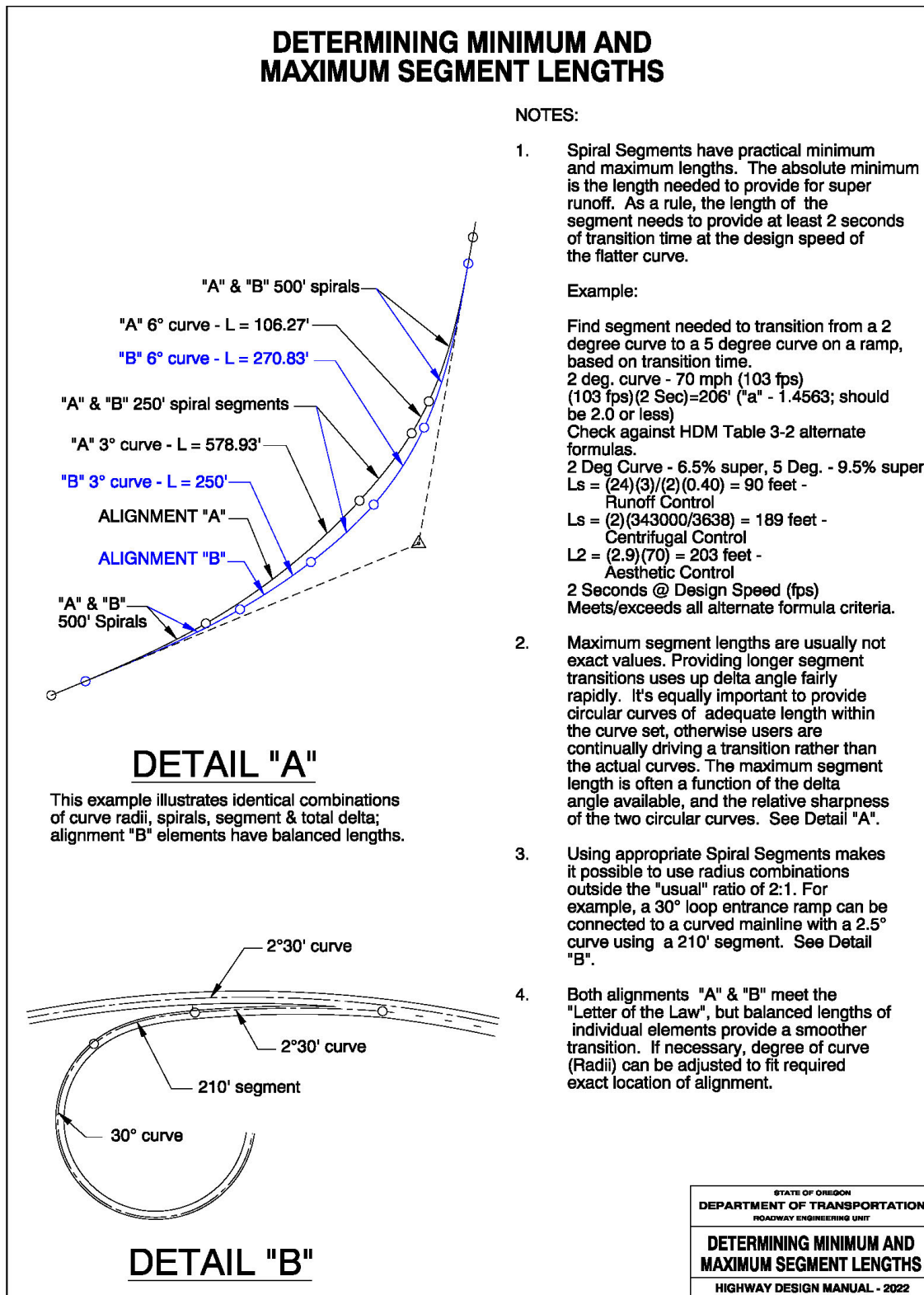

Figure 200-49: Example of Spiral Segment in a Mainline Alignment Situation



Section 219 Vertical Alignment

Design vertical curves to provide sight distance at least equal to the stopping sight distance for the indicated design speed. The vertical sight distance is the distance from the operator's eye, assumed to be 3.5 feet above the pavement to the point 2 feet above the pavement. While objects less than 2 feet in height may be encountered on Oregon highways, it is rare that a complete emergency stop would be required to avoid such an object. Therefore, it is typically not practical to design for an object height of less than 2 feet. The minimum lengths of vertical curves which may be used for the various design speeds are shown in Figure 200-50 and Figure 200-51.

It is desirable to increase the length of vertical curves over that shown whenever it is economically possible. When the algebraic difference in the grades is small, the minimum curve length is three times the design speed. This is represented by the vertical lines in the lower left hand corner of Figure 200-50 and Figure 200-51. An angle point is considered a curve with a length of zero, and therefore, does not meet the minimum standard.

The intent of 3R projects is to preserve and extend the pavement life of the roadway. Reconstructing the vertical alignment of preservation projects is typically outside the project purpose, need, and scope. However, analysis of potential safety benefits is performed to determine the need to include vertical curve improvements.

219.1 3R Freeway Vertical Curvature and Stopping Sight Distance

For all 3R freeways, stopping sight distance shall be those values established in the AASHTO Green Book for the selected design speed. See Chapter 3 of the Green Book for sight distance information.

219.2 3R Vertical Curvature and Stopping Sight Distance (All Highways Except Freeways)

For 3R projects, evaluate reconstruction of crest vertical curves if:

1. The crest obstructs from view major hazards such as intersections, sharp horizontal curves, or narrow bridges, and the current year ADT is greater than 2000, or
2. The design speed based on the existing Stopping Distance is more than 20 mph below the ODOT Urban Standard (urban) or project design speed (rural) and the current year ADT is greater than 2000.

After evaluation, if reconstruction of the vertical curve is not justified or cost effective, or the curve is not reconstructed to new construction standards, a design exception is required.

219.3 4R Vertical Curvature (All Highways)

The minimum lengths of vertical curves which may be used for the various design speeds for crest vertical curves and sag vertical curves are shown in Figure 200-50 and Figure 200-51. The figures provide the Rate of Vertical Curvature (K) values based on design speed and stopping sight distance requirements. *It is desirable to increase the length of vertical curves over that shown whenever it is economically possible.* **When the algebraic difference in the grades is small, the minimum curve length is three times the design speed.** This is represented by the vertical lines in the lower left hand corner of Figure 200-50 and Figure 200-51. **An angle point is considered a curve with a length of zero, and therefore, does not meet the minimum standard.** Figure 200-52 and Figure 200-53 provide information for sag and crest vertical curve formulas and design.

Figure 200-50: SSD Crest Vertical Curve

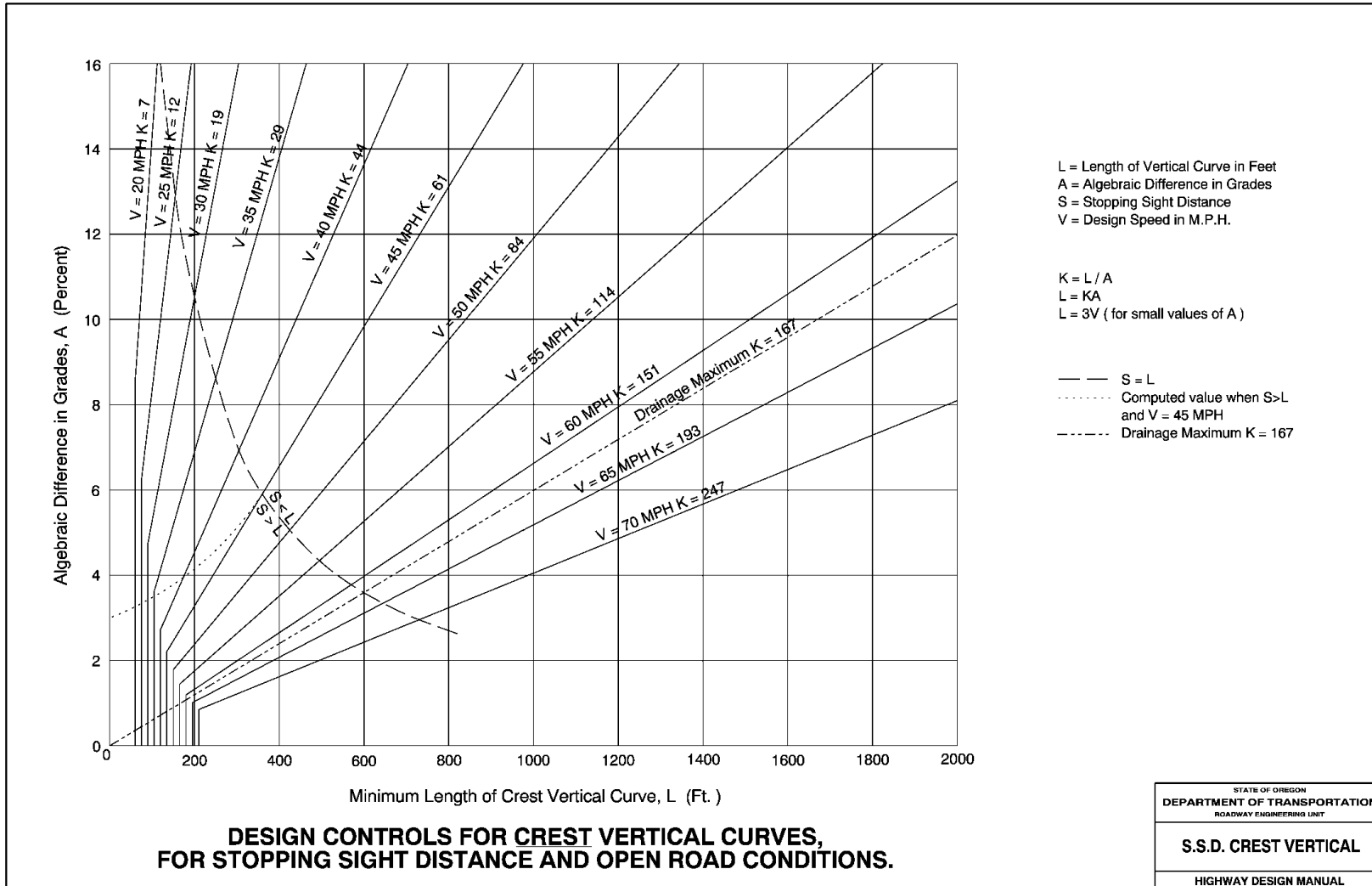

Figure 200-51 : SSD Sag Vertical Curve

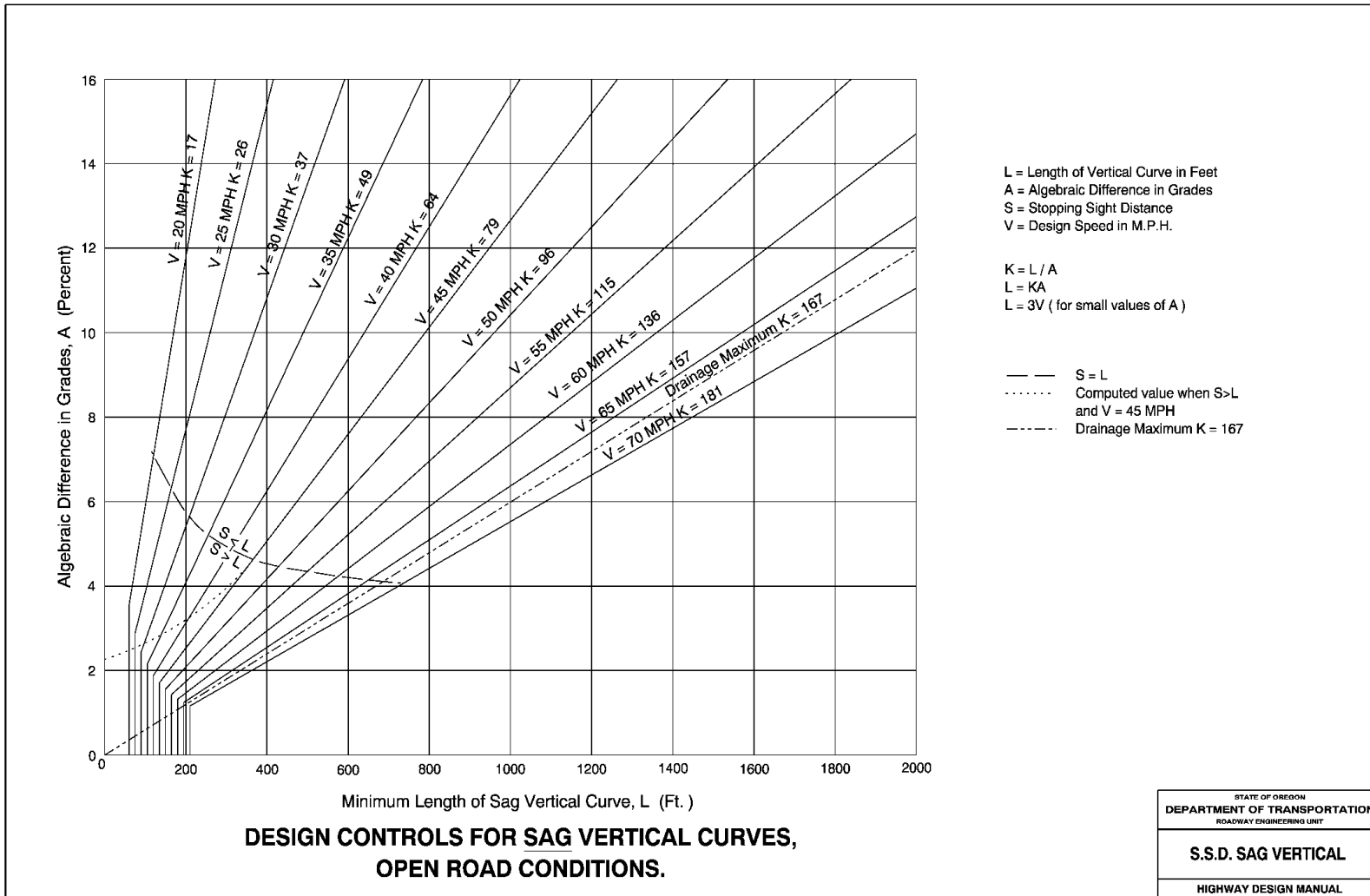
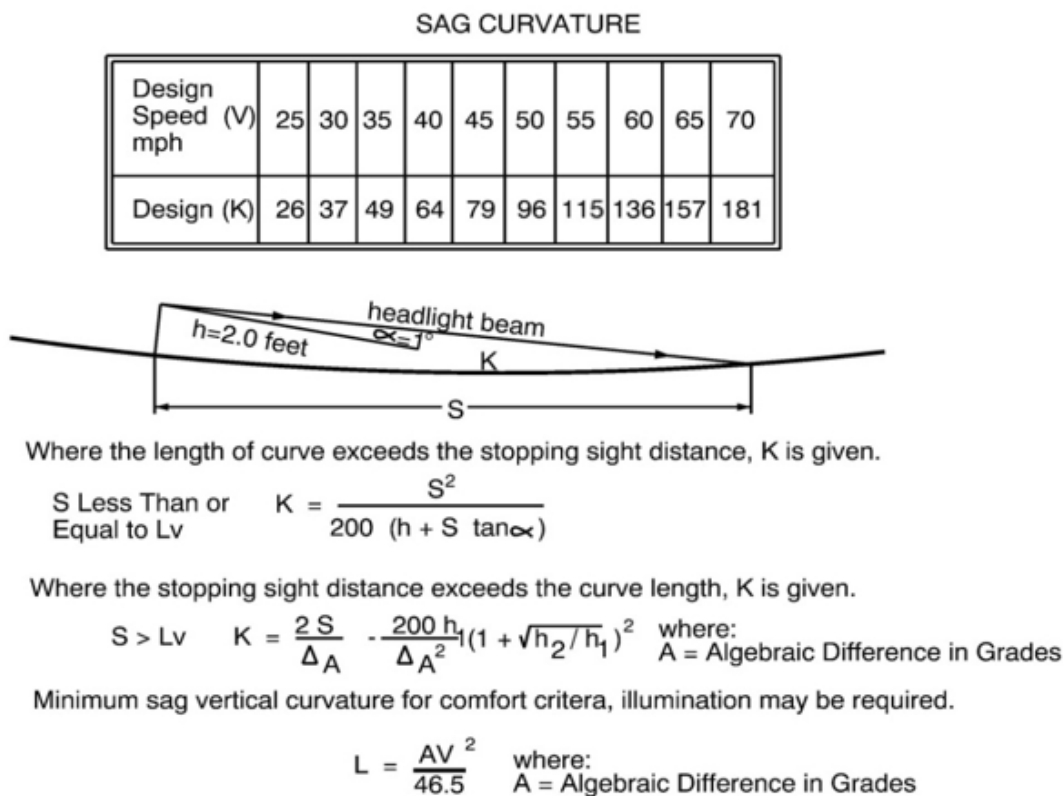
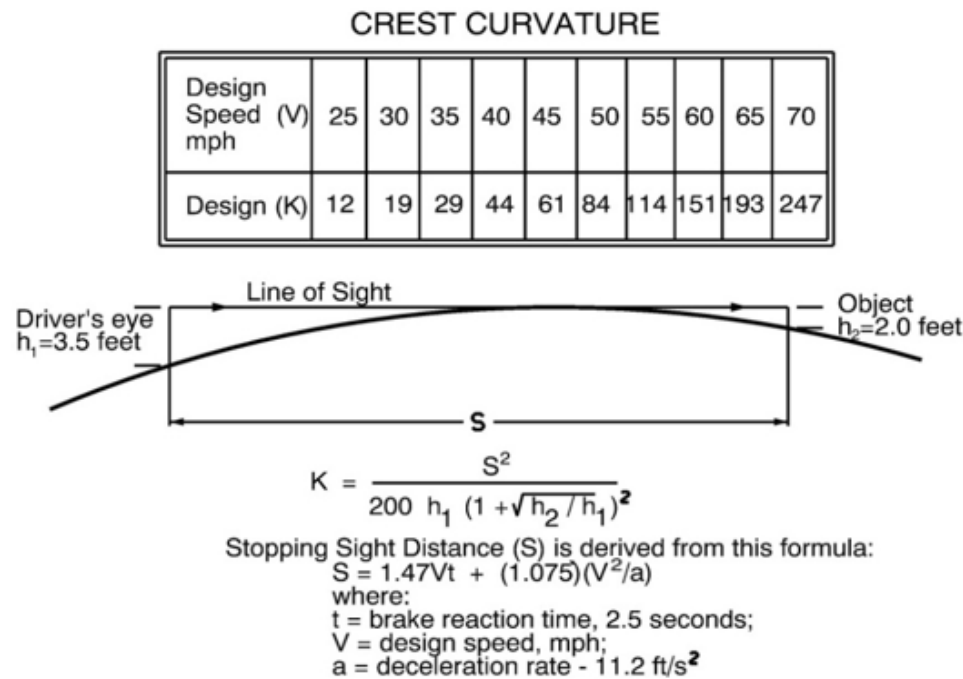

Figure 200-53: Crest and Sag Vertical Curves



Section 220 Combined Horizontal and Vertical Alignment

The combined effect of the horizontal and vertical alignment must be considered during design of a highway (see the AASHTO Green Book). In addition, the designer is responsible for providing all the final horizontal and vertical geometry for the project, including bridges.

When designing for the coordination of horizontal and vertical alignment, the following issues need to be considered.

- 1. Balance curvature and grades. Tangent alignment mixed with steep grades or flat grades with excessive curvature is poor design. A balance of both elements leads to uniform operation, aesthetically pleasing, and safe designs.*
- 2. Vertical and horizontal alignments should complement each other.*
- 3. Avoid locating sharp horizontal curves at or near the top of a crest vertical curve or at the low point of a sharp vertical curve.*
- 4. Design horizontal and vertical curvature to be as flat as possible in the area of intersections to allow for proper sight distance.*

On summits with both horizontal and vertical curves, make the horizontal curve longer than the vertical curve. There is a limit of one vertical curve within a horizontal curve. It is desirable to provide a tangent grade on tangent alignment. Once the sight distance is broken by a curve in either the vertical or the horizontal alignment, there is little value in maintaining a tangent. The ideal alignment extends from control point to control point without unnecessary curvature in between. However, extremely long tangents may cause problems, due to driver boredom. (See the AASHTO Green Book)

In the design of two-lane arterials, provide for passing at frequent intervals. Work with the Region Traffic Engineer on locations for passing opportunities or passing or climbing lanes. Figure 200-54 illustrates coordination of horizontal and vertical alignment on curves. Figure 200-55 illustrates examples of poor coordination of horizontal and vertical alignment.

Figure 200-54: Coordination of Horizontal and Vertical Curves (AASHTO, 2018)

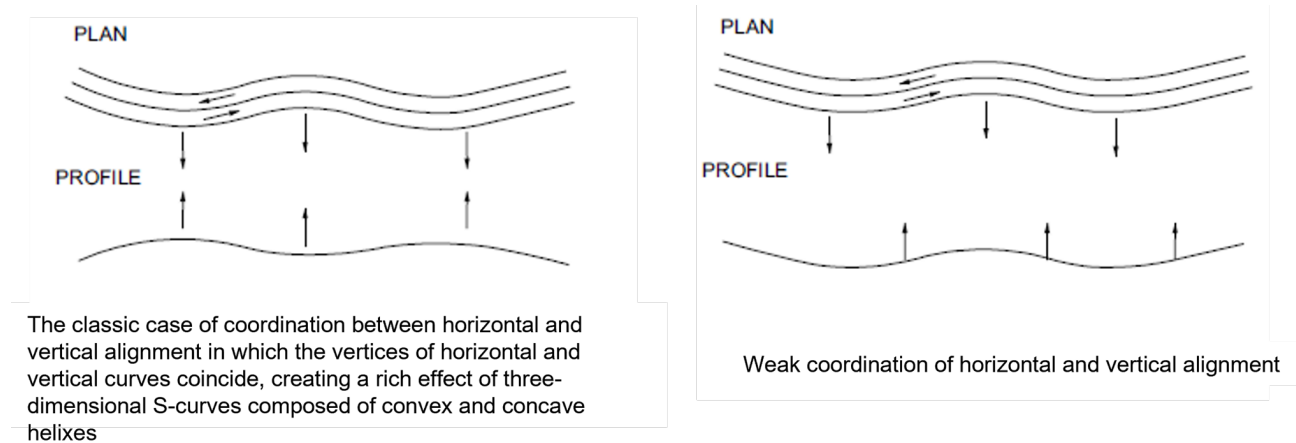
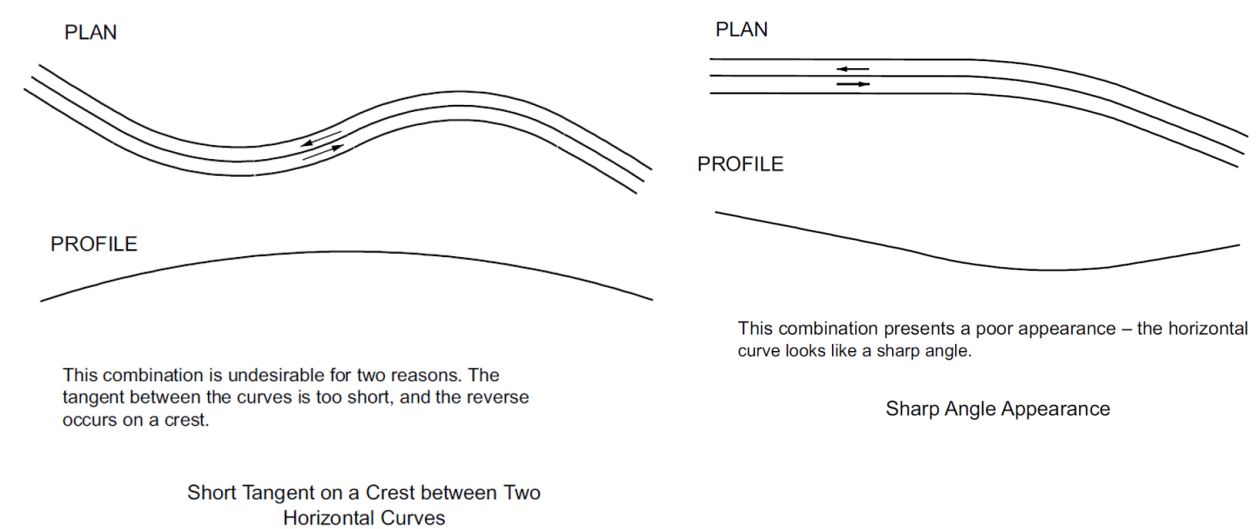

Figure 200-55: Examples of Poor Combined Horizontal and Vertical Alignment (AASHTO, 2018)



Section 221 Grades

221.1 General

On grades of 4 percent or greater, it is advantageous to carry the profile grade at the edge of the traveled way to the right of the centerline ascending the grade. The superelevation is obtained by raising the center and left side of the roadway on curves turning to the right going uphill, and by lowering the center and left side of the roadway on curves turning to the left. Where this rule applies and the horizontal curve passes over a summit, the profile grade is carried on the

outside of the curve developing superelevation by lowering the center and inside edge of the roadway. For grades less than 4 percent, use the standard method of superelevation in conformance with Section 218.

It is important to take into account the impact from grades in the different design elements such as acceleration and deceleration lanes, stopping sight distance, passing sight distance, and intersection sight distance. Table 3-2 in the 2018 AASHTO Green Book page 3-6 shows the effects of grade on stopping sight distance.

Due to 3R projects being primarily dedicated to preservation, a design requirement for 3R grades is to maintain the existing grade, except where 3R projects are on interstate highways or freeways. Adjust grades on 3R interstate highway or freeway projects to meet design criteria. Design exceptions are required if grades cannot meet design criteria.

221.2 3R and 4R Freeway Grades

3R projects that include modernization work will need to follow the 4R grade requirements for that portion of the preservation project that includes the modernization work type. Table 200-15 provides design guidance for both 3R and 4R freeway grades. Generally, grades on urban and rural freeways are very similar. In urban and mountainous areas, increased grades are allowed due to terrain. Care should be taken in urban areas to minimize the use of steep grades due to the close spacing of interchanges and the multiple speed changes needed in an urban area. In an urban environment, the driver must process large amounts of information in short periods of time. Steep grades make it more difficult for lane changes and other maneuvers to be made. **The 4R maximum grade for flat, rolling, or mountainous are 3 percent, 4 percent, and 5 percent respectively.**

Table 200-15: Maximum Freeway Grades

Design Speed (mph)	Maximum Freeway Grades (%) for Specific Design Speed								
	50	60	70		50	55	60	65	70
Design Standard	4R*				3R*				
Terrain									
Flat/Level	-	-	3		4	4	3	3	3
Rolling	-	-	4		5	5	4	4	4
Mountainous	5	5	5		6	6	6	5	5

* In urban areas grades may be 1% steeper.

Grades 1% steeper in urban areas require a design exception.

221.3 4R Urban and Rural Expressway Grades

The length and percentage of grade affects the operation of the expressway. Long, steep grades reduce the efficiency of the facility, especially when there are high truck volumes. Table 200-16 below provides design standards for Urban and Rural Expressway Grades.

Table 200-16: Maximum Expressway Grades (%) for Specific Design Speed

Design Speed (mph)	45	50	55	60	65	70
Urban	6	6	5	5	5	5
Rural		6		4		3

221.4 4R Rural Arterial Grades

Rural arterials cover a wide range of topographic areas. Highway grades can have a significant effect on traffic flow and operations and therefore should be as flat as possible without negatively affecting drainage needs. Highways that carry substantial amounts of truck or recreational vehicle traffic will be greatly affected by steep grades. Wherever possible, steep grades should be avoided. Where this is not practical, the length of grade should be minimized. **The maximum grade allowed on rural arterial, collector and local highways can be found in Table 200-17, Table 200-18, and Table 200-19.** Where terrain impacts traffic flow, provide frequent passing opportunities where possible.

In some mountainous terrain, long steep grades are unavoidable. In these instances, consider the use of truck climbing lanes. On continuous steep downhill grades, the use of truck escape ramps may be necessary. Where truck escape ramps are deemed necessary, they should be designed as an ascending grade type per the AASHTO Green Book. Climbing lanes are covered in more detail in Part 700.

Table 200-17: Rural Arterial Maximum Grades (%) for Specific Design Speed

Design Speed (mph)	45	50	55	60	65	70
Level Terrain	5	4	4	3	3	3
Rolling Terrain	6	5	5	4	4	4
Mountainous Terrain	7	7	6	6	5	5

Table 200-18: Rural Collector Maximum Grades (%) for Specific Design Speed

Design Speed (mph)	45	50	55	60	65	70
Level Terrain	5	4	4	3	3	3
Rolling Terrain	6	5	5	4	4	4
Mountainous Terrain	7	7	6	6	5	5

Table 200-19: Rural Local Route Maximum Grades (%) for Specific Design Speed

Design Speed (mph)	45	50	55	60	65	70
Level Terrain	5	4	4	3	3	3
Rolling Terrain	6	5	5	4	4	4
Mountainous Terrain	7	7	6	6	5	5

221.5 4R Urban Arterial Grades

As with any urban arterial, the grade selected can have an effect on how well an arterial operates, especially on urban arterials that have a high percentage of trucks, heavy vehicles, and transit vehicles. *Steep grades impact speeds and stopping distances and can have an effect on intersection operations. Although grades should be kept as flat as possible, the existing terrain and context of an urban arterial may make it difficult to achieve the design grade requirements.* Table 200-20 below provides the design requirements for maximum urban arterial grades.

Table 200-20: Urban Arterial Maximum Grades (%) for Specific Design Speed

Design Speed (mph)	25	30	35	40	45	50+
All ODOT Urban Contexts	8	8	7	7	6	6

Section 222 Design Vehicles and Accommodation of Design Vehicles

In selecting the appropriate design vehicle, many factors must be considered such as the number and type of trucks, functional classification of the highway, freight route designation, and the effect on other modes including pedestrians and bicycles. Space allocation for all modes of transportation must be considered, not just the needs of the largest vehicles. The design vehicle is typically the largest vehicle that normally uses the highway without a special permit. After determining the appropriate design vehicle, a decision needs to be made as to the appropriate level of accommodation in the design for the location. For example, at an intersection, will the radii be designed for the design vehicle, or will it be designed to accommodate the design vehicle? The concept of designing for the design vehicle is to provide a path for the vehicle that is free of encroachments upon other lanes. Providing a design that accommodates the design vehicle means that some level of encroachment upon other lanes is necessary for the vehicle to make a particular movement (see Part 500). A balanced design approach takes into consideration more than just the amount of room the design vehicle requires. For example, what is the intended operating speed of the facility? Fully designing for a large design vehicle may result in higher than desired speeds. What is the context? In a traditional downtown, it is desirable to provide priority to pedestrians over other modes. An example of an intersection that would need to be designed for the design vehicle with no encroachment into adjacent lanes would be a rural stop-controlled intersection with a state highway, the highway being two lane or multi-lane with higher speeds and/or high traffic volumes. If a traffic study concludes that finding a gap in multiple traffic flows is not possible, the intersection would need to be designed for the design vehicle so it can turn into a single lane. Other factors to consider are the effects on pedestrians and bicycles: For example, large turning radii at intersections result in long crossing distances and longer exposure times for pedestrians with potential negative impact to safety. Also, with larger radii, motorists tend to take turns at higher speeds. So, designing for a large design

vehicle tends to make the intersection less desirable for most of the users of the intersection. Therefore, rather than designing for the design vehicle, the design should normally accommodate the design vehicle in consideration of the overall safety of the highway.

In addition to the design vehicle, the occasional larger vehicle may need to use the highway. Coordination with the Commerce and Compliance Division and the Statewide Mobility Program group in the Statewide Project Delivery Branch is required to determine if any vehicles larger than the design vehicle are allowed on a highway by permit and what level of accommodation needs to be provided. The Commerce and Compliance Division (CCD) receives requests to move special loads through the state. Although these loads are not to be used for design purposes, there will be occasion where the appropriate route for these special loads, which are typically accompanied by pilot vehicles, will need to be developed. These special load requests from CCD normally are sent to Technical Services, but the Region Technical Centers may also receive the requests. Region staff should work with the Region Mobility liaison and with Technical Services when CCD requests for these special loads occur. Additional information can also be found in the ODOT Mobility Procedures Manual.

For more information on design vehicle accommodation for private and public road approaches and intersections, see Part 500 (Intersection Design).

Section 223 Traffic Characteristics

Roadway designers need a basic understanding of traffic flow and characteristics (including bicycle, pedestrian, freight and transit) to be able to develop safe and effective facility designs. This understanding is as fundamental to sound design as geometric, hydraulic, or structural considerations. Designers don't necessarily need to be experts on analysis, but they do need to be familiar with basic concepts in order to develop projects that will meet agreed upon goals and objectives.

There are four major components that affect the character and flow of traffic:

1. Vehicles (including autos, trucks, bikes, pedestrians, and transit)
2. Facility character and functional requirements (not the same as Functional Class)
3. Drivers/Users
4. Traffic Demand that is to be accommodated (again, for all types of traffic)

Additionally, there are other factors that affect the four main components, including:

1. Weather/Seasonal Variations
2. Completeness of the facility network (Functional Class -Arterials, Collectors, Locals; Bicycle Networks – Local, State; Pedestrian Network – Local, State)
3. Overall context/location (Rural, Suburban, Urban) and development patterns

4. Availability of Transit/Park & Ride, etc.
5. Intermodal connections (such as Rail to Highway, Highway to Ports)

Analysis of traffic data (for all modes) can be complex and is subject to many variables. Designers need to consult with ODOT's Transportation Planning Analysis Unit (TPAU) and Region Traffic Units to get a clear understanding of traffic data and characteristics. Since traffic staff are always included as members of Project Teams, they can provide specific and detailed guidance to design personnel. Decision making on projects needs to be a collaborative effort - designers should also communicate back the "physical world" perspective during decision making and design. Neither traffic nor geometric design is an exact science, so allowances are necessary to accommodate the inherent uncertainties.

Tools are available to aid design personnel in understanding traffic needs and analysis. Chapter 2 of the AASHTO Green Book has an excellent detailed discussion on Traffic Characteristics – it is written with designers in mind. TPAU has developed an *"Analysis Procedures Manual"*. This document provides current methodologies, practices, and procedures for conducting long term analysis for ODOT plans and projects.

Section 224 Accommodation of other Modes in Design

Roadway facilities are designed and operated to enable safe access for all users, including pedestrians, bicyclists, motorists, and transit riders of all ages and abilities. The design team should understand the difference between "accommodating" versus "designing for" a given mode and apply consistent principles within the project context. Multimodal design considerations depend on the intended function of the corridor, as well as balancing trade-offs and objectives from local plans. For example, consider a roadway designed primarily for mobility for motorized vehicles. The design is required to "accommodate" other users, such as pedestrians and bicycles, but it will not attract a wide range of vulnerable users. A roadway intended to serve and attract non-auto users, however, should be "designed for" multimodal users. This means mobility for motorized vehicles is a lower need and may allow for some congestion.

224.1 Accommodation and Design for Pedestrians and Bicyclists

ORS 366.514 requires that ODOT, cities and counties provide walkways and bikeways wherever a highway, road or street is being constructed, reconstructed, or relocated. They are not required if:

1. Scarcity of population or other factors indicate an absence of any need;
2. Costs are excessively disproportionate to need or probable use; or
3. Where public safety is compromised.

In addition to Oregon statutes, FHWA also provides policy based on various sections in the United States Code (U.S.C.) and the Code of Federal Regulations (CFR) in Title 23 - Highways, Title 49 - Transportation, and Title 42 - Public Health and Welfare to incorporate safe and convenient walking and bicycling facilities into transportation projects. Every transportation agency, including the federal department of transportation, has the responsibility to improve conditions and opportunities for walking and bicycling and to integrate walking and bicycling into their transportation systems.

The designer should start with the assumption that accommodation is required and seek an exemption only where it is obvious that one of the three above exceptions applies. The designer should also reference planning documents to see if prior efforts have already established if sidewalks or bikeways are needed.

On a simple preservation project additional accommodation may not be required. As part of the practical design process, the project charter will identify the purpose and need of the project, including any required accommodation for pedestrians and bicyclists.

However, restriping of paving only projects can afford opportunities to make incremental improvements to bicycle facilities at low or no cost to the project. Adding a bike lane or buffered bike lane with restriping where one did not exist can be a big improvement to the system with minimal impact to the project scope, schedule, or budget.

The Americans with Disabilities Act (ADA) is a federal Civil Rights law that mandates both the private and public sectors to make their facilities accessible. For ODOT, that means that pedestrian facilities must be built so people with mobility, visual or cognitive limitations can easily use them. ODOT standards incorporate the most current guidance in the [ADA Standards for Accessible Design](#), [Public Right-Of-Way Accessibility Guidelines](#), and the [Architectural Barriers Act \(ABA\)](#).

One of ODOT's three goals tied to the agency mission statement is to "improve Oregon's livability and economic prosperity". Many ODOT highways operate as the "Main Street" in a community. Shopping districts with the most comfortable and pleasurable pedestrian walking

environments have shown to be the most successful. Therefore, comprehensive pedestrian design that includes greater sidewalk width and more pedestrian friendly accommodations, rather than basic accommodation of minimum sidewalk width is appropriate in Special Transportation Areas (STAs) (see Part 800) and Urban Mix or Traditional Downtown/Central Business District contexts. Bicycle tourism is a significant industry in Oregon that also influences Oregon's livability and economic prosperity. Comprehensive bicycle facility design, rather than basic accommodation is appropriate along designated bicycle routes and in urban contexts.

Refer to Parts 800 and 900 for design standards of pedestrian and bicycle facilities. Incorporate the following principles outlined in Section 224.1.1 and Section 224.1.2 when designing pedestrian and bicycle facilities.

224.1.1 Design Principles for Pedestrians

This section is a general discussion of designing for pedestrians. For in-depth discussion and information, see Part 800.

1. Pedestrians tend to take the shortest route between two points. The pedestrian's path of travel should be direct with minimal out-of-direction travel.
 - Pedestrian walkways should not meander.
 - Provide walkways on both sides of a street. When sidewalk is provided on one side of the street, but not the other, most pedestrians tend to stay on the side without sidewalk, rather than cross the street; the sidewalk itself does not lure most pedestrians to cross the street.
 - The typical maximum distance pedestrians walk are as follows: 1 mile for work commute, ½ mile for transit and other trip purposes.
2. Pedestrian travel patterns are less predictable than those of bicyclists or motorists.
3. About 50 percent of pedestrian traffic is shopping related. About 11 percent is commute related. Peak pedestrian volumes are not during the peak commuter times for motor vehicles, they usually occur near the noon hour.
4. Designs must accommodate pedestrians of varying abilities and disabilities.
 - Obstructions in walkways reduce the effective width for pedestrians and can make walkways inaccessible for persons with disabilities.
5. Regular pedestrian crossing opportunities should be provided in business districts.
 - All legs of an intersection should typically be open to pedestrians.
 - All legs of an unmarked intersection are crosswalks.

- ORS801.220 says, “Whenever marked crosswalks have been indicated, such crosswalks and no other shall be deemed lawful across such roadway at that intersection.” Some interpretations of this statute have suggested marking one crosswalk at an intersection means the crosswalk on the opposite leg of the intersection no longer exists unless it is marked too. ODOT is implementing ORS801.220 in the following way. The above quoted sentence from ORS801.220 clarifies that a marked and unmarked crosswalk cannot both exist across the same leg of an intersection – the marked crosswalk takes precedence. Thereby limiting the impact of ORS801.220 to one leg of the intersection, and not affecting the legal crossing at the other leg of the intersection.

224.1.2 Design Principles for Bicyclists

This section is a general discussion of designing for bicyclists. For in-depth discussion and information, see Part 900.

1. Bicycle accommodation is required on all highways, except those described in OAR 734-020-0045.
 - Bicycle accommodation needs to be continuous on both sides of the roadway.
2. Bicycles are vehicles and are accommodated as roadway users where possible.
 - The path for bicyclists should be direct, logical and close to the path of motor vehicle traffic, making bicyclist movements visible and predictable to motorists.
 - Safe on-street bicycle accommodation includes bicycle-safe drainage grates and adjusting manhole covers to street grade.
3. Designs may also accommodate bicyclists of lesser abilities.
 - Only in rare cases should bicyclists be required to proceed through intersections as pedestrians.
 - Oregon law (ORS 814.420) requires bicyclists to use a bike path or bike lane, rather than the roadway travel lanes, if a bike path or bike lane is provided.
4. Bicyclists are affected by steep grades more than motorists or pedestrians are.

Section 225 References

Blueprint for Urban Design (BUD), ODOT, 2019

Main Street...When a Highway Runs Through It: A Handbook for Oregon Communities, DLCD/ODOT, 1999

Oregon Roadway Design Concepts, ODOT

Designing Livable Streets and Trails Guidance, Metro, 2021

Roadside Design Guide, AASHTO - 2011

Oregon Bicycle and Pedestrian Guide, ODOT - 2011

AASHTO: A Guide for Achieving Flexibility in Highway Design (2004)

AASHTO: A Policy on Geometric Design of Highways and Streets

FHWA: Flexibility in Highway Design